

S T O R M E

TATA MOTORS



STORME Refresh Top 5-

2

1

**The REAL
SUV - Class-
leading
Power,
Torque,
Speed, and
Ground
Clearance**

2

**Integrated
ConnectNext
Infotainment
System by
HARMAN™**

3

**Stylish
Interiors
with Multi
Function
Steering
Wheel**

4

**Commanding
Road
Presence
with
Refreshed
Exteriors**

5

**All Terrain
4x4 with
Shift on Fly
– ESOF**

1) Advanced 2.2 L VARICOR 156 PS Power & 400 Nm Engine

3

Feature

Advanced 2.2 L VARICOR 400 Engine with 156 PS Power & 400 Nm Torque

Advanced 2.2 L Turbo Diesel Engine

Torque = 400 Nm @ 1750-2500 rpm

Power = 156 PS @ 4000 rpm



	Safari Storme VX (4x2)	Fortuner 2.5L MT	XUV 500	Scorpio mHawk Engine
Power	156 PS @ 4000 rpm	144 PS @ 3400 rpm	140 bhp @ 3750 rpm	120 bhp @ 4000 rpm
Torque (Nm @ rpm)	400 @ 1750-2500	343 @ 1600-2800	330 @ 1600-2800	280 @ 1800-2800

Comparison of Torque

4

Advanced 2.2 L Turbo Diesel Engine

Torque = 400 Nm @ 1750-2500 rpm

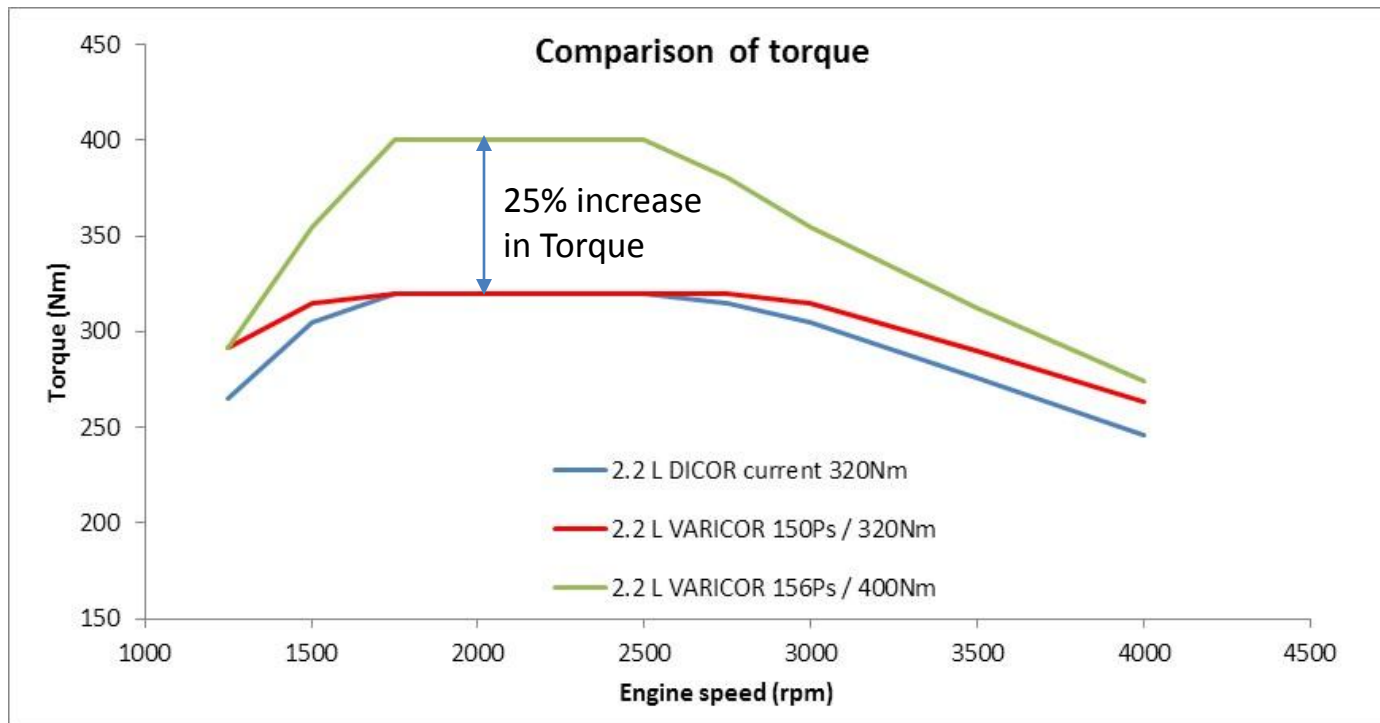

The All New VARICOR 400 engine produces 400 Nm of Torque at a Lower rpm, resulting in greater pulling power on inclines & superior drivability at low speeds

Benefit

- The driver can change to higher gears sooner at lower engine rpms, to get the vehicle moving
- Low End Torque enables a relaxed drive.

Comparison of Power

5

Advanced 2.2 L Turbo Diesel Engine

Power = 156 PS @ 4000 rpm

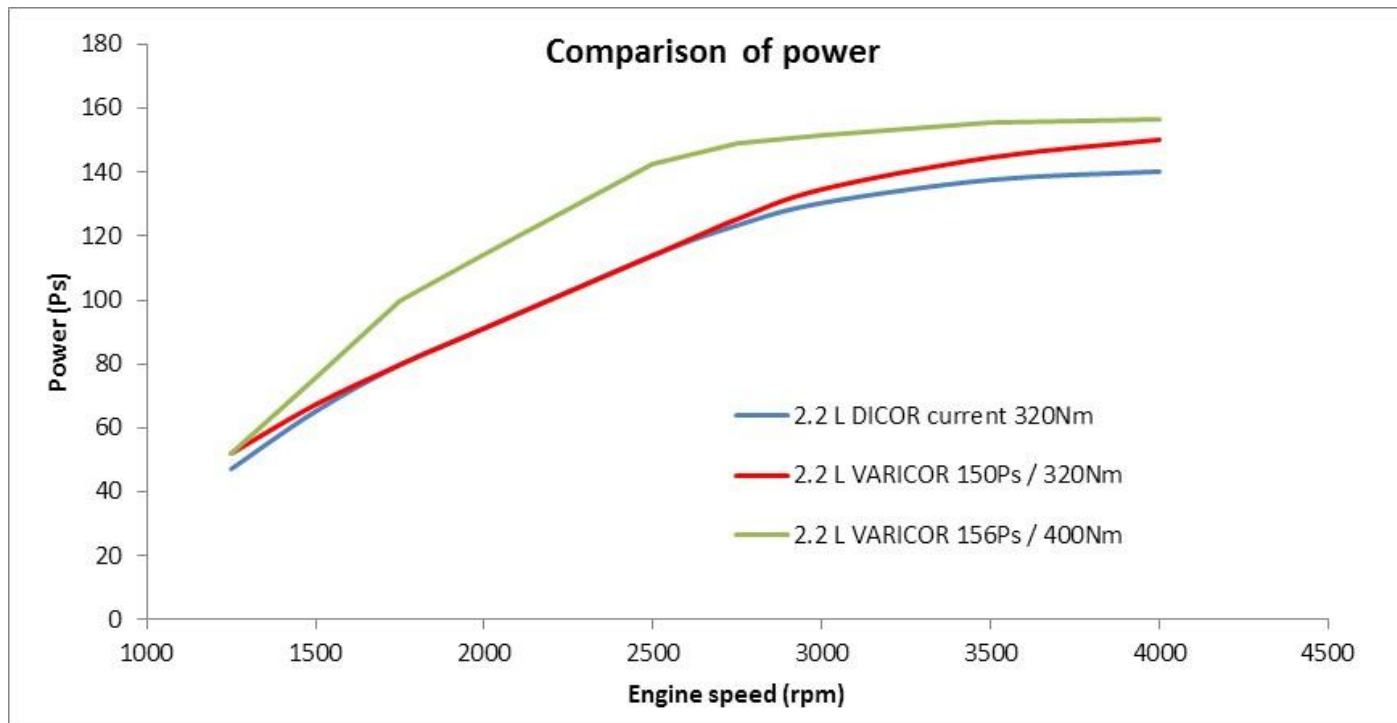

The All New
VARICOR 400
engine produces
156 PS of Power
at a Lower rpm,
resulting in class
leading
acceleration

Benefit

- More than enough power to squirt through those tight gaps in traffic, and also to climb those tough off-road obstacles

Acceleration Performance

6

Acceleration Performance	Safari Storme 400 Nm	Safari Storme 320 Nm	Fortuner	XUV 500
0-60 kmph	5.2	5.7	5.9	6.0
0-100 kmph	12.8	13.8	13.3	13.4

Source – Internal test measurement

Restart Grade

7

	Safari Storme 400 Nm	Safari Storme 320 Nm	XUV 500
Restart Grade (%)	32	33	28

Source – Internal test measurement

Benefit

- Restart Grade measures the ability of a vehicle to climb an inclination, from a complete stop on the inclination without taking a start and building momentum.
- Ability to climb a Higher Grade % is tougher and our Safari Storme 400 does it better.

All New 6-Speed Gearbox

8

Feature

ALL NEW G6450 6 speed manual gearbox

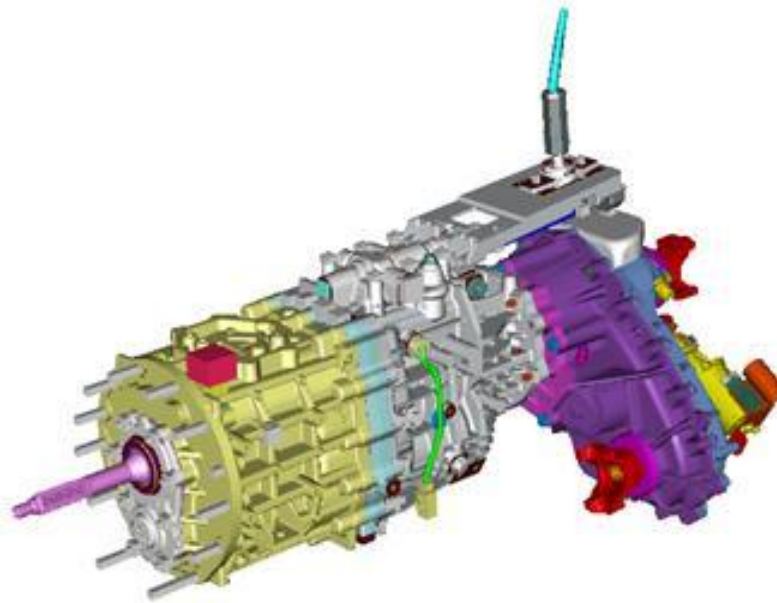

Benefit

- Optimum balance between gear throws and gear shift effort
- Wider ratio spread of 6 speeds allows a better balance of good acceleration in lower gears, and quieter cruising in higher gears.

2) Integrated ConnectNext Infotainment system by HARMAN™

9



****World famous HARMAN™ Infotainment system –used only in most luxury Premium Brands.***

CONNECTNEXT

-Features

10

Entertainment features



Play Music via – FM/AM,
CD, USB, iPod, Aux and
Bluetooth Audio



6 speaker Audio



Speed Dependent
Volume Control



- LCD screen
- CD
- Radio
- USB
- AUX
- iPod
- Bluetooth

Informative features



Bluetooth Hands free, Phone book
download, Audio streaming

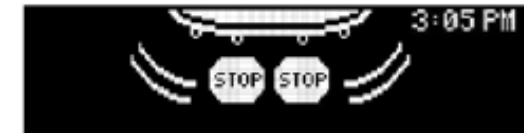

Reverse parking
sensor Display

Comfort and convenience features



Steering Wheel
Controls



IR remote for Rear
passengers

3) Stylish Interiors with Multi Function Steering Wheel

11

- Stylized Java Black Interiors with Silver Accents



- Multi Function Steering Wheel

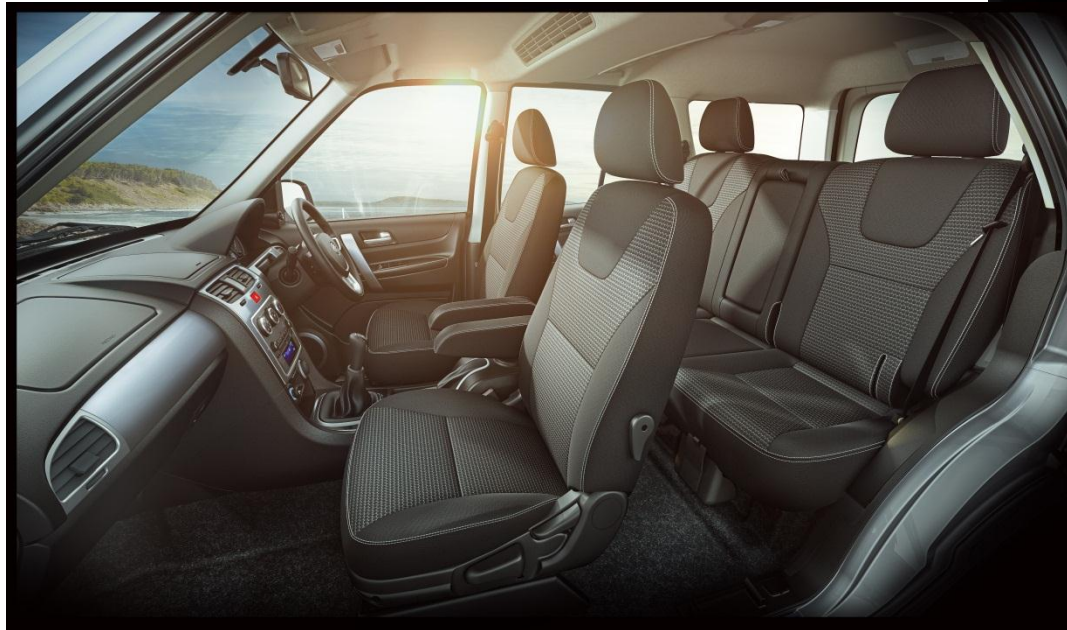

Stylized Java Black Interiors

12

Feature

Stylized Java Black Interiors with Silver Accents

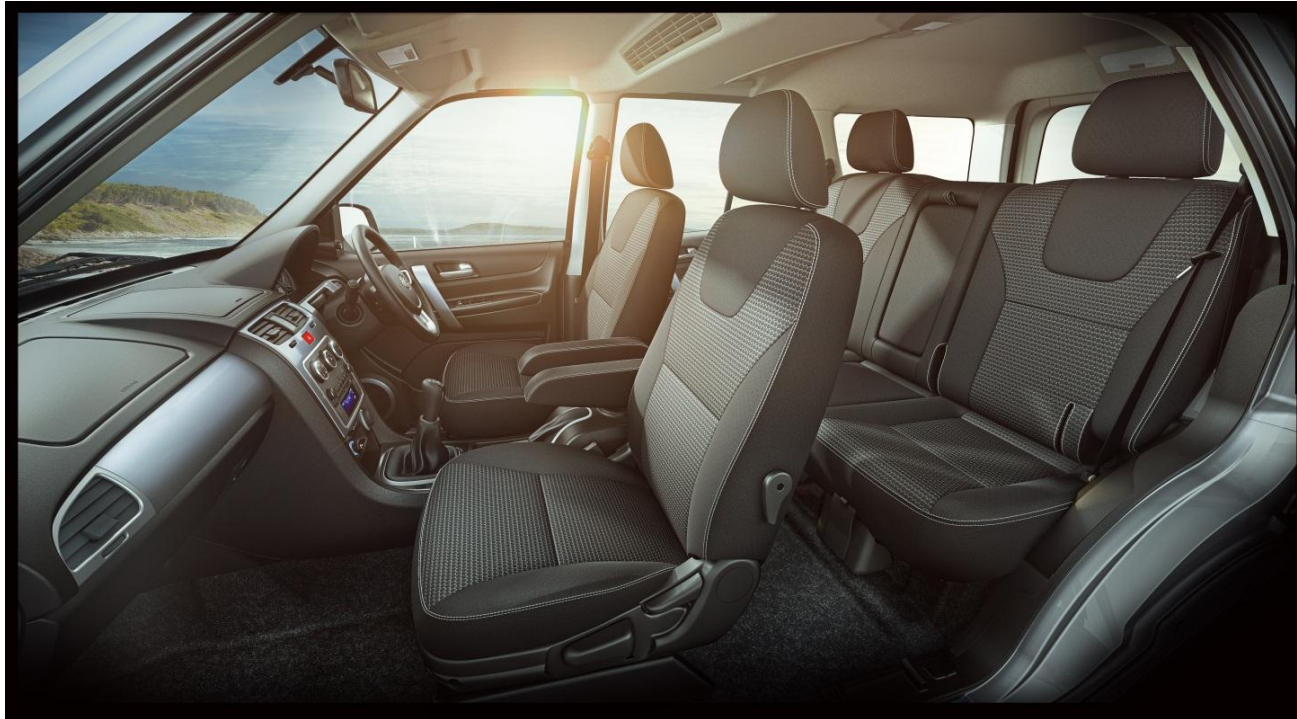

Benefit

Adds to Premium Looks and doesn't fade or stain easily

Stylish all New Seat Fabric

13

Comfort

Feature

Seats with
Elegant Stitching pattern



Benefit

Adds to the luxurious feel inside the cabin

Stylish Rear Arm Rest with Storage and Flip Cup Holders

14

Comfort**Feature****Rear Arm rest with Storage Box with Flip Cup Holders**

1. Foldable armrest 2. Knob

Benefit**Adds to comfort and convenience especially while driving long distances**

4) Commanding Road Presence

15



International Exterior Design –

The Aggressive Upper and Lower Grille gives the STORME an International and more Sporty SUV Look

5) All Terrain 4X4 with Shift on Fly – ESOF

16

4x4 Electronic Shift-on-Fly (ESOF)

Now on Centre Console



Shift from 4x4 to 4x2 on the move

ESOF-Uses of 4x2 and 4x4 Drives

17

Using the Drive Modes -2H/4H/4L

- 4x2 HI = for regular every day driving
- 4x4 HI = for off-road use, for better traction, in slippery conditions. Not to be used on on-road.
- 4x4 LO = when extreme inclines or slopes are to be negotiated in off-road conditions.

DRIVENEXT





OTHER FEATURES

Other Features

- Electrically Operated Heated Powerfold ORVMs
- Rear AC
- All 4 Disc Brakes
- Follow me Home -Approach Lights
- Easy to Drive with
 - Low Turning Radius (5.4 m)
 - Class leading Ground Clearance (200 mm)
 - Self-Adjusting Clutch

	Safari Storme	XUV 500	Scorpio
Turning Radius (in m)	5.4	5.6	5.4
Ground Clearance (in mm)	200	160	165

Stylish Electronic ORVMs

20

Utility**Feature****Electrically Operated Heated Powerfold ORVMs**

**Image used for Representative purpose only*

**Benefit**

**Easy operation of ORVM adjust and open function from within the cabin
Also gives clear visibility in rainy and foggy conditions**

DRIVENEXT

21

Feature

Self Adjusting Clutch

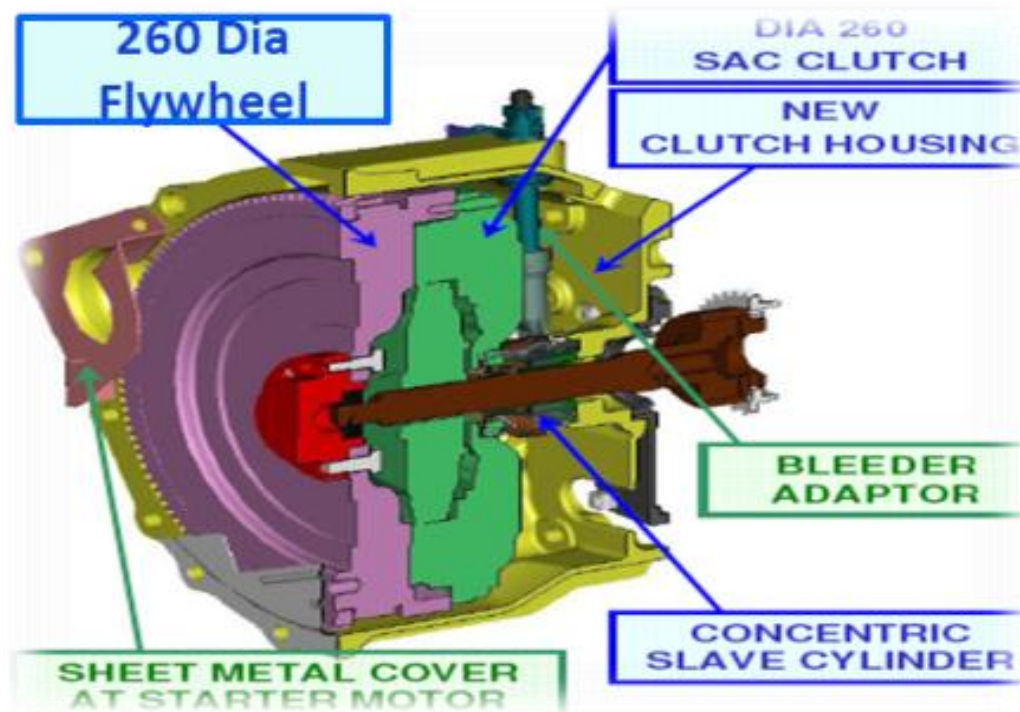

Benefit

Reduces constant Pedal Effort on clutch and preserves the clutch Life

Follow me Home -Approach Lights

22

- ❑ A practical, safety conscious innovation designed to light the interior of a garage or a path to the front door after the car has been locked.
- ❑ Follow Me Home activates the dipped beams and sidelights of the car for 30 Secs

The keys are having 3 buttons for different functions as below. The Flip key is having an additional Ejection Button for folding/Unfolding of blade.

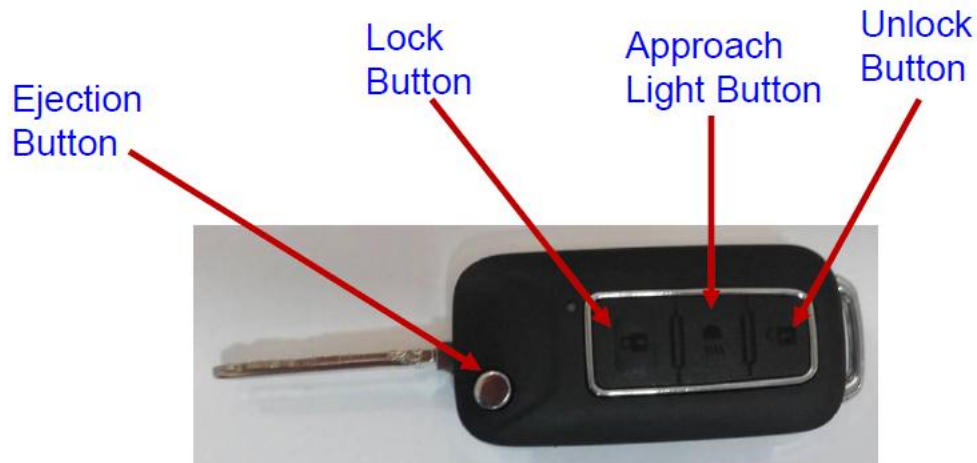



WARRANTY, SERVICING & OWNERSHIP COSTS

STORME: Real Peace of Mind

24

- ❑ **Original warranty:** 3 years / 1,00,000 kms whichever occurs earlier
- ❑ **Engine Warranty :** 3 Years / 1,50,000 Kms
- ❑ **Extended Warranty:** Additional 1 year / 50000 kms on expiry of Original Warranty.
- ❑ Extended Warranty can be purchased till 730 days from date of purchase of vehicle.
- ❑ **RSA toll free number-** 1800 209 7979



THANK YOU

