

ISUZU Motors India Private Limited.

9th Floor, Prestige Centre Court-Office Block,
Vijaya Forum Mall, No. 183, N.S.K. Salai,
Vadapalani, Chennai – 600 026,
Tamil Nadu, India.

Toll Free No.: 1800 4199 188

ISUZU
NEVER STOP

For more information visit: www.isuzu.in | www.isuzumux.in | [f](#) ISUZU Motors India | [yt](#) IsuzuMotorsIndiaChannel

**MORE MUSCLE.
MORE HEART.**



THE NEW
**ISUZU
mu-x**
ALL MUSCLE. ALL HEART.

MORE WAYS TO WIN.

Life is an adventurous drive - exciting, exhilarating but demanding and exacting at the same time. You need the capability to exceed all expectations, meet all challenges and yet deliver with panache. And when you go out on this journey, you need an allrounder by your side - like the new ISUZU mu-X.

A supremely capable SUV, built tough with the muscle to match the most grueling environment, and yet with the most generous heart - a sanctuary for you and your family. A versatile machine, with a contemporary design inspired by the grace, grandeur and majesty of the eagle. Are you ready to experience the thrilling blend of muscle and heart?

THE NEW
ISUZU
mu-X
ALL MUSCLE. ALL HEART.





MORE WAYS TO SOAR.

The eagle is a true embodiment of freedom and ascendancy, soaring high above the sky with a majestic presence that inspires awe and admiration. The new mu-X takes design cues from the powerful and dominating eagle that adds to its commanding presence on the road, and off the road. The Front Grille and Headlamps, with their sharp lines create an aura of an all-penetrating vision. The Bi-LED Auto-levelling Projector Headlamps with LED DRL and a Guide Strip projects a powerful white light with long range to keep you focused on what's ahead. The newly crafted diamond cut Alloy Wheels, Shark-fin Antenna, LED Rear Position Lamps and crisp lines that flow from the front to the rear showcase a muscular yet aerodynamic machine.



Eagle-inspired Design



Bi-LED Auto-levelling Headlamps with DRL

LED Rear Position Lamps



Diamond Cut 18-inch Alloy Wheels

Dual-tone Spoiler and Shark-fin Antenna

DOMINATE WITH MORE.

The engine in the new muX builds upon the legacy and learnings of the last 100 years of ISUZU; an efficient powertrain that creates a go anywhere, capability.

The 3.0 litre Ddi VGS Turbo Hi-Power engine offers 177 PS of power with a flat torque curve that gives the muX a progressive performance and total control for you on the highways. Its advanced anti-friction induction hardened cylinder bores, heavy-duty steel timing chain and graphite coated pistons all work in tandem to create a highly durable and reliable engine that delivers on all your expectations. Now dominate any kind of terrain, anywhere.



Flat Torque Curve

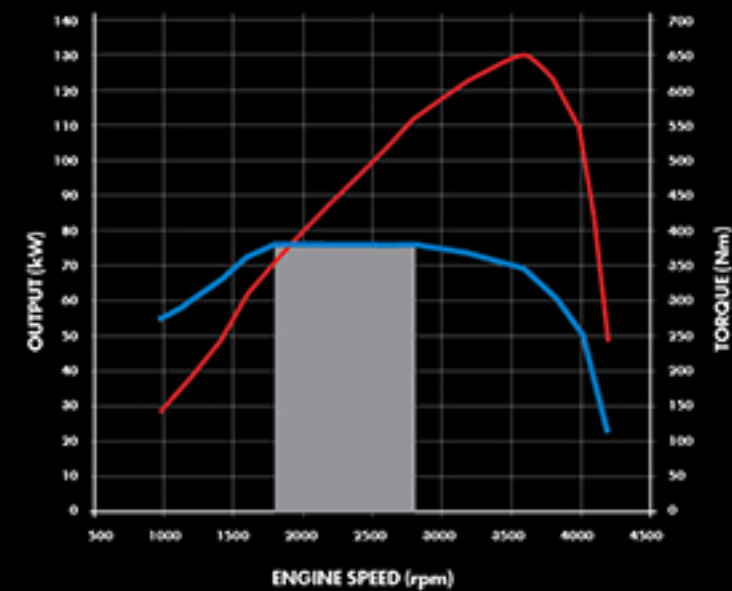

Advanced Anti-friction Induction Hardened Cylindrical Bores



Heavy-duty Steel Timing Chain



Graphite-coated Pistons



Sequential Shift Automatic Transmission

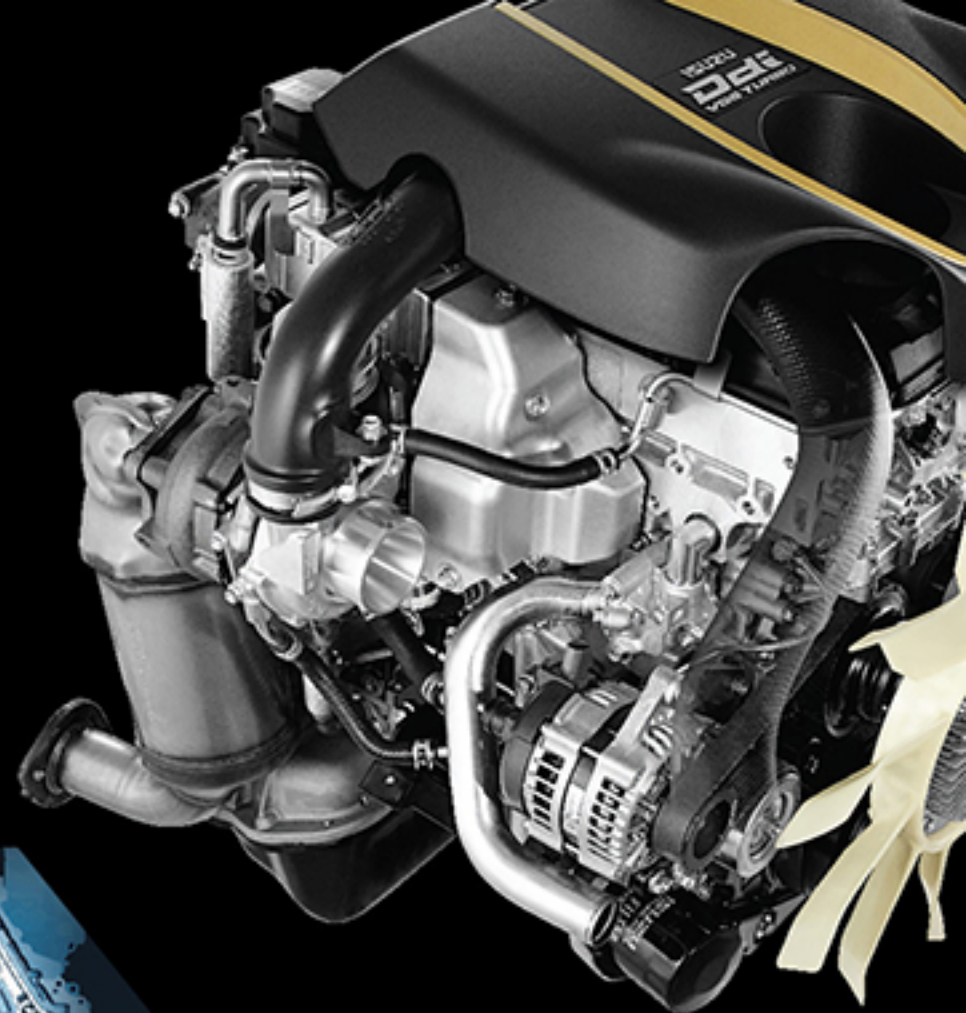

ISUZU Ddi Hi-Power Engine

3.0 Litre	130 kW 177 PS	VGS VSS
---------------------	----------------------------	--------------------------



2H

4H

4L

Underbody Steel Skid Plate

Heavy-duty Ladder Construction Chassis

"Shift-on-the-fly" 4x4 Select Dial for Fingertip Terrain Control

Front Independent Double Wishbone Coil Suspension with Stabilizer Bar

MORE METTLE FOR YOUR PASSIONS.

Wherever your passions may take you, the muX is engineered to drive you there. Thanks to the "Shift-on-the-fly" 4x4 select dial with low and high range, the transition from street to off-road driving is seamless, making you an unstoppable force. With excellent ground clearance and superior approach, departure and breakover angles, the muX has the capability to confidently get you in and out of just about anywhere. It is also equipped with a double-wishbone front suspension, a heavy duty gearbox and a wide track with a long wheel base for extra stability, and front steel underbody plate for protection, so that you have more than enough muscle to take on even the most challenging terrains.

Off-Roading Prowess**

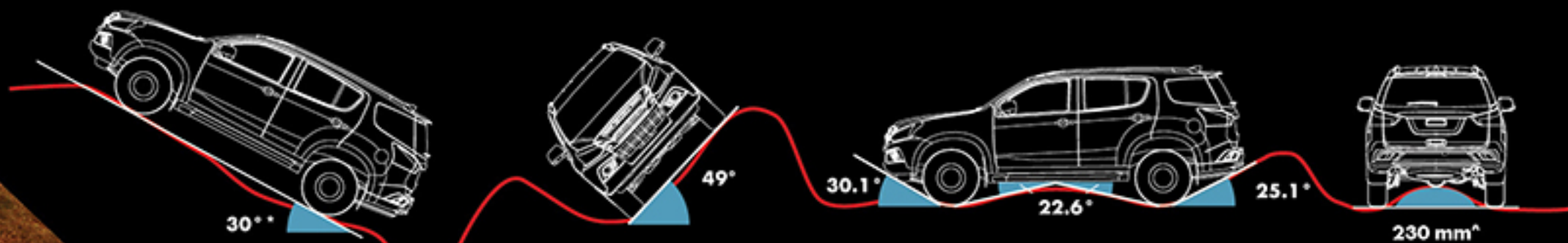

**The mentioned values are based on internal measurements done. *Ground clearance under unladen condition at the rear axle.

*In 4x4 mode. **In 4x4 variant.



MORE STURDY. MORE PROTECTED.

Confidently challenge any condition because the new mu-X is more than prepared to protect you. The high tensile steel body with tailor-welded blanks and crumple zones with anti-intrusion bars create a protective cocoon for your family. To give you a more controlled drive, the new mu-X comes with Hill Start Assist (HSA) and Hill Descent Control (HDC) both, to keep you sure-footed on every adventure. It packs an array of active safety features like Electronic Stability Control (ESC), Traction Control System (TCS), 4-Channel 4-Sensor Anti-Lock Brake System (ABS) with Electronic Brakeforce Distribution (EBD). On the other hand, front seat belts with pre-tensioners and load limiters, and 3 ISOFIX child seat anchorages make for a comprehensive passive safety system. And for adverse scenario a 6-Airbag system ensures protection for your family.



High Tensile Steel Body Construction with Tailor-welded Blanks and Side Anti-intrusion Bars



3 ISOFIX Child Seat Anchorage



All-wheel Disc Brakes



Rear Parking Assist Camera



Front Seat Belt with Pre-tensioner and Load Limiters



HILL-START ASSIST
HSA



HILL-DESCENT CONTROL
HDC

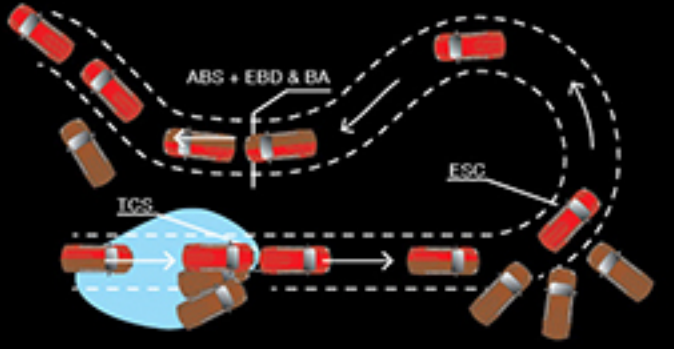

WITHOUT WITH ABS EBD ESC TCS

6 AIRBAGS

Driver, front passenger, front side and full length curtain



MORE SPACE FOR MEMORIES.

It's a crowd-pleaser outside but on the inside, it's a family-pleaser through and through. The new mu-X is a spacious 7-seater with a supremely comfortable interior, now reimagined in a luxurious black. The new soft pad dashboard and trims add a touch of refinement and the ergonomics of the twin-cockpit design makes the controls easily accessible to the driver and the front passenger. While the Quilted Leather Seats, adjustable headrests and other creature comforts keep you cozy inside, the penta-link rear suspension adds to the comfort on long drives. A unique feature of the mu-X is the spacious and comfortable 3rd row with an easy ingress and egress made possible by a quick one touch tumble 2nd row seat. The mu-X is not just luxurious on seating space but is also versatile with a range of storage spaces. All in all, the new mu-X feels as good as it drives.



Spacious and Comfortable Seating with Premium Quilted Leather Seats for 7 People

Flexi Seating Options

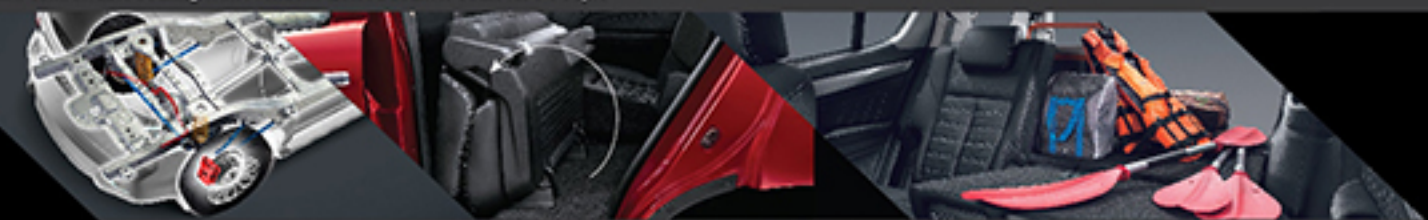

Penta-link Rear Suspension

One Touch Fold and Tumble Second Row Seats

Full Flat Boot Space



PES (Passive Entry and Start System)

Start and Stop Button

6-Way Power Adjustable Driver Seat

3D Electro-luminescent Meter with MID

MORE CONVENIENCE AT YOUR FINGERTIPS.

The new mu-X is designed in a way that the comforts of your home ride with your family. Step in and begin your journey effortlessly with the Passive Entry and Start Stop System. The 6-way power adjustable driver seat offers you a relaxed driving position with the slide of a switch. The newly designed 3D instrument cluster with chrome rings displays clear and concise data, ensuring you're well informed. And while you are at it, enjoy your home theatre on wheels with an 8-speaker live surround sound. So now, take those family outings to a whole new level with the amplified comfort and convenience of the new mu-X, all at your fingertips.



Climate Control AC

Cabin Cooling Vents for All Three Rows



Steering Mounted Audio and Cruise Control

Integrated 7-inch Touchscreen Entertainment System

Roof-mounted Sound System with 'Live Surround Sound'

Glove Box with Light and Power Outlet

USB Port in 2nd Row

Rear Centre Armrest with Cupholders



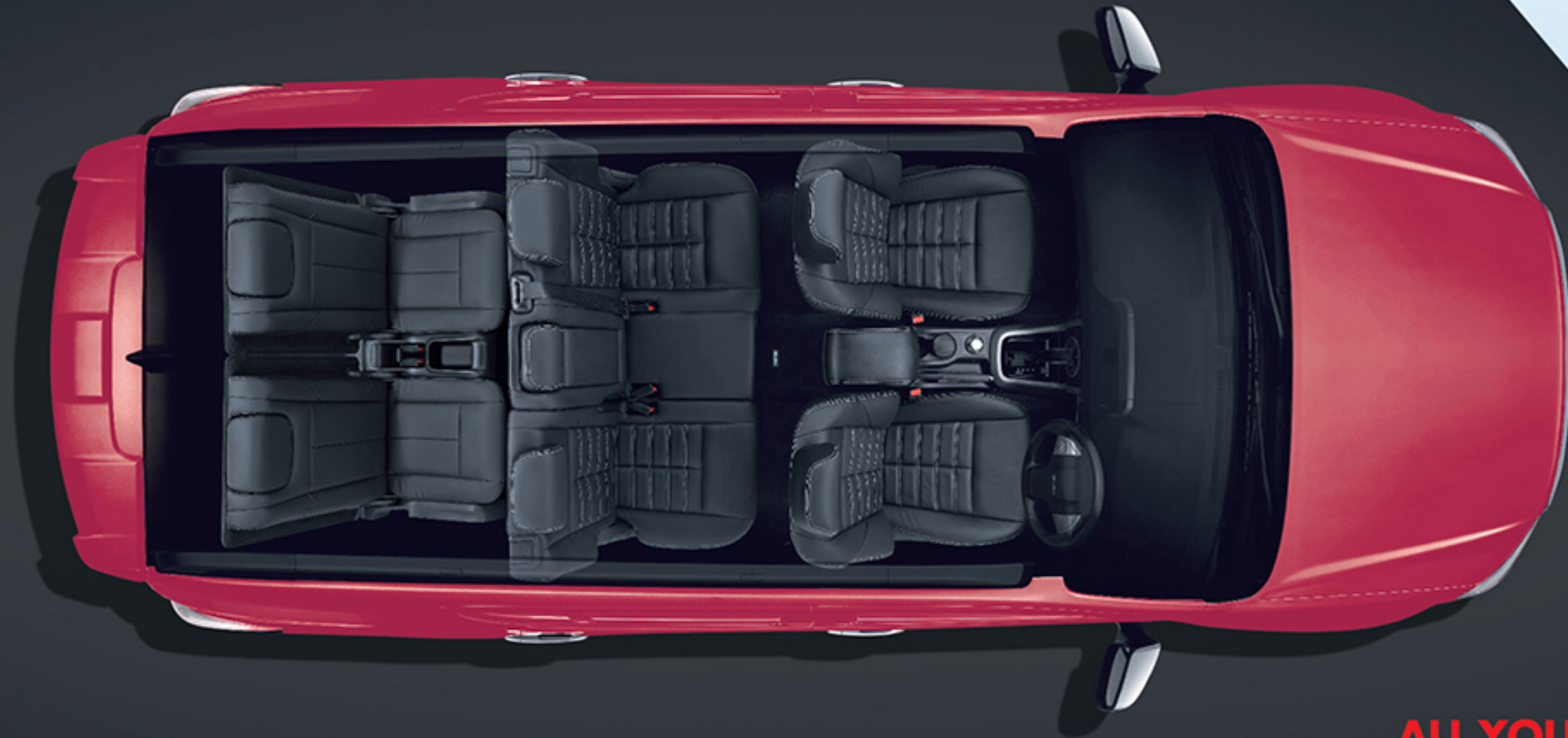

Premium Twin Cockpit Interiors with Soft Touch Panels



Premium Quilted Leather Seats

**ALL YOU NEED.
AND MORE.**

PERSONALISE YOUR mu-X

Choose from the whole range of accessories designed for the new ISUZU mu-X to make it even more stylish and personalised.

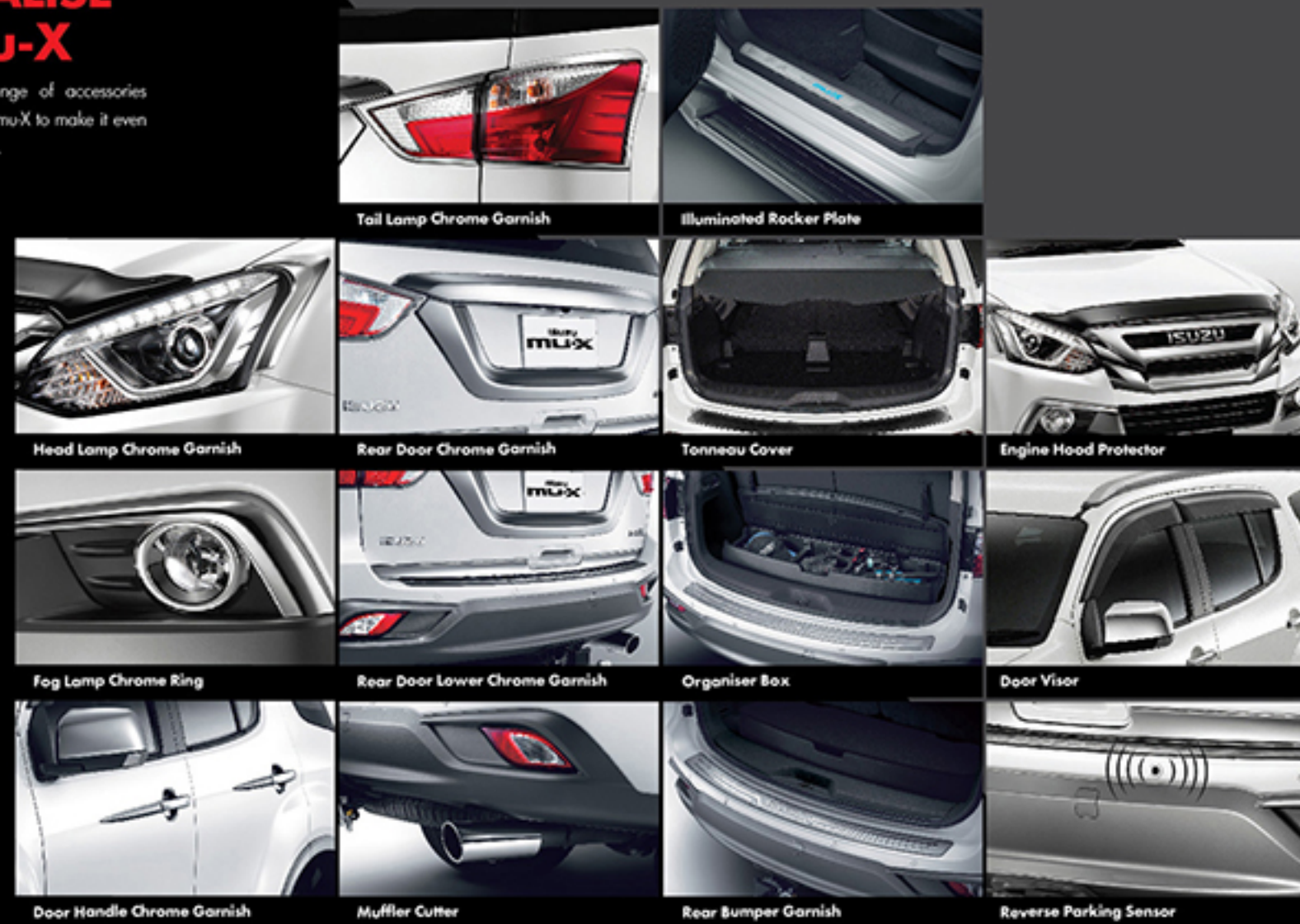

100
YEARS OF EXCELLENCE

AN UNSTOPPABLE ZEST

A true icon of Japanese automotive engineering, ISUZU is bolstered by a legacy that spans over a hundred years. With operations in 25 countries, it is a true global brand that is coveted in over 100 countries worldwide. Manufactured with the promise of 'engineered for life', today the ISUZU name is synonymous with reliability, durability and long lasting vehicles. Renowned for their fuel efficiency, ISUZU vehicles are also powerful and adventurous to the core. Staying true to this philosophy, ISUZU has grown into a brand that is adored not just by adventure seekers but also by those who believe in superior automotive engineering and unmatched style in their vehicles.

The new ISUZU mu-X too embodies this promise and offers you something that no other vehicle can offer; the freedom to go on any adventure you choose while also giving your family the best in safety and comfort. So, no matter what your passions and pursuits are, with ISUZU you NEVER STOP.

This map is a generalized illustration only and is not intended to be used for reference purposes. Map shown is not to scale.

ISUZU
NEVER STOP

SPECIFICATIONS & FEATURES

SPECIFICATIONS

ENGINE	
Type	ISUZU Ddi VGS Turbo Hi-Power
Description	3.0 litre turbo diesel, in-line 4-cylinder, DOHC, 16-valve
Displacement	2999 cc
Max. Power	130 kW (177 PS) @ 3600 rpm
Max. Torque	380 Nm @ 1800-2800 rpm
Bore x stroke	95.4 mm x 104.9 mm
Compression ratio	17.5 : 1
Cylinder head	ISUZU-patent special aluminium alloy with double-walled water jacketing
Cylinder block	Cast iron upper with advanced anti-friction induction-hardened cylinder bores, cast alloy lower
Valve train	Heavy-duty steel chain-driven dual overhead camshafts (DOHC), roller rockers, 4 valves per cylinder
Fuel injection	Electronic high pressure common-rail diesel-direct injection (Ddi)
Air induction	Intercooled Variable Geometry System (VGS) turbo charger with Variable Swirl System (VSS)
Pistons	Special graphite coated pistons with heat-resistant integrated ring carrier (top ring) & nickel composite piston rings
Emission level	Bharat Stage 4
TRANSMISSION	
Type	Automatic with Sequential Shift & Brake Shift Lock Electronically controlled with Adaptive Grade Logic & fuel-saving Lockup Torque Converter → Adaptive Grade Logic Control: holds gear in varied-gradient ascents, selects gear on steep descents to hold speed with engine braking → Uphill & Downhill Drive Control (transmission based)

4x4 system	"Terrain Command" control with 'Shift-on-the-fly' 2-high ↔ 4-high selection at up to 100kmph
Drivetrain system	Electronic Stability Control (ESC) & Traction Control System (TCS)
CHASSIS	
Frame	Separate, full-length heavy-duty ladder construction chassis
Front suspension	Independent, Double wishbone, coil springs, gas shock absorbers, stabiliser bar
Rear suspension	Penta-link coil suspension, gas shock absorbers, stabiliser bar
AXLES	
Front	Independent 4x4: fully floating with outer CV & inner double offset joints
Rear	Rigid semi-floating banjo with hypoid final drive
STEERING	
Type	Speed-sensitive variable capacity power-assisted rack & pinion system
Adjustment	Tilt-adjustable steering wheel
BRAKES	
Type	Power-assisted via 10.5 inch servo unit 4-Channel 4-Sensor Anti-Lock Brake System (ABS) with Electronic Brakeforce Distribution (EBD) & Emergency Brake Assist (EBA)
Front	300 mm dia ventilated front disc with twin-pot calipers
Rear	318 mm dia ventilated rear disc
WHEELS	
Rim	18 x 7J-33, Diamond-cut Alloy
Tyre	255 / 60 R18
Full-size alloy spare wheel	
CAPACITY	
Seating	7 persons
Fuel Tank	65L capacity High Density Polyethylene (HDPE) tank

UTILITY SPACE		
2 nd & 3 rd row folded flat	1830 L	
3 rd row folded flat	878 L	
Behind 3 rd row	235 L	
PERFORMANCE		
Min. Turning Radius	5.8 m	
Max. Gradeability	4x2 mode	25°
	4x4 mode	30°

FEATURES

SAFETY & SECURITY	
4-Channel 4-Sensor Anti-Lock Brake System (ABS) with Electronic Brakeforce Distribution (EBD)	
Emergency Brake Assist (EBA)	
300 mm Front Ventilated Disc Brakes with Twin-pot Calipers	
318 mm Rear Ventilated Disc Brakes	
Electronic Stability Control (ESC)	
Traction Control System (TCS)	
Hill Start Assist (HSA)	
Hill Descent Control (HDC)	
6 Airbags : Driver, front passenger, front side and full length curtain	
Pre-tensioners with load limiters for front seat belts	
3-point retractable seat belts for all seating positions	
Emergency locking retractor (ELR) for all seat belts	
3 ISOFIX childseat anchorage for 2 nd row seats	
Automatic door lock release on airbag deployment	
High tensile steel body construction with tailor-welded blanks	
Anti-intrusion bars inside side doors	
Child-proof rear door locks	
Rear parking assist camera	
Engine immobilizer	
Anti-theft alarm system	
Driver & passenger seat belt warning	
Audible & visual headlight-ON & parking light-ON warning	

Rear window demister with timer	
High Density Polyethylene (HDPE) fuel tank	
Centre high mount LED stop lamp	
Collapsible steering column	
PROTECTION	
Underfront steel plate skid/splash shield	
Steel plate sump guards	
Steel plate transfer protector*	
Steel plate on leading edge of fuel tank	
Fuel tank fire protector	
EXTERIOR STYLE	
Eagle-inspired sharp & muscular exterior design	
Bi-LED projector headlamps with auto-levelling	
LED rear position lamps	
Sharp & sleek headlamp & taillamp design	
Recessed front fog lamps with chrome garnish	
LED Day-time Running Lights (DRL) & light guide integrated in headlamps	
Two-tone metallic grey-body coloured front & rear bumpers	
Multi-spoke diamond-cut alloy wheels	
Double slot chrome radiator grille	
Chrome door handles	
Chrome tailgate garnish	
Chrome fold-in power door mirrors with integrated turn indicators	
Aluminium side steps	
Shark-fin antenna with gun-metal finish	
Wraparound rear glass - quarter glass & rear windshield	
Roof rails (max. load capacity 60kg)	
Dual-tone rear spoiler	
INTERIOR STYLE	
Twin-cockpit ergonomic interior design	
Sporty lava black interior with silver highlights	
Luxurious quilted soft leather seats	

*only for 4x4 variant

Soft pad on all side door armrests, door trims & front floor console armrest
Premium finish dashboard with soft touch panels
Leather wrapped steering wheel
Piano black finish on gear shift bezel
Chrome finish on side doors inner levers, gear shift bezel, front console cup holders & air vent knobs
Bright silver finish on shift-on-the-fly 4x4 knob*, steering, auto AC console & IP center console
Premium Barleycorn Guilloche finish on door inserts
SEATING
Front anatomically designed bucket seats
6-way power adjustable driver seat
60:40 split 2 nd row seats with fold away centre arm rest
One-touch fold & tumble 2 nd row seats
50:50 split fold 3 rd row seats
One-touch fold 3 rd row seats
Flat fold 2 nd & 3 rd row seats
Adjustable headrests for all seats, including centre seat
IN-CABIN STORAGE
Glovebox with light
Upper utility box on IP
3 Power outlets-IP centre console, upper utility box & rear cargo area
3 USB ports-IP centre console, entertainment system & 2 nd row floor console
Dual purpose driver and front passenger cup holder tray
IP with two retractable cup holders-cum-utility boxes
Overhead console with twin map lights & flip-down sunglasses holder
Front floor console with two cup holders
2 nd row armrest with two cup holders
Front & Rear door storage with bottle holders
3 rd row trims with cup holders
3 rd row floor console with cubby hole

Coat hooks on 2 nd row assist grips
Cargo net hooks in cargo area
COMFORT & CONVENIENCE
Climate control air-conditioning with integrated heater & demister
Cabin cooling vents for all 3 rows of seats
Separate blower control for rear seats
Pollen and fine particle air filter
All power windows with driver side one-touch down/up & delay closing
Passive Entry & Start System (PESS)
Central locking with keyless entry
Power-adjustable & power-foldable door mirrors with turn indicator lights
Cruise control system
Integrated 7-inch touchscreen entertainment system with DVD/CD/USB/MP3/FM/AM/AUX compatibility, with iPod®, Bluetooth® phone & audio streaming
Live Surround Sound roof-mounted sound system with 8 speakers (front dash, front doors, rear doors and roof)
Tilt-adjustable steering wheel with power steering
Steering wheel with easy-select cruise and audio controls
3D Electro-luminescent meters with Multi-Information Display (MID) & chrome rings
Terrain Command 4x4 select dial with 2-High, 4-High and 4-Low range*
Windscreen wipers with variable intermittent sweep modes
Rear window wiper
Day/night interior rear view mirror
Sun visors with vanity mirror (co-driver side) and ticket retaining strap (driver side) Fixed
A-pillar assist-grips for 1 st row
Roof mounted retractable door assist-grips for 1 st & 2 nd rows
Fixed C-pillar assist-grips for 3 rd row
Height-adjustable upper mounts for front seat belts
Premium carpet mats with safety locking clips (driver side) & foot protection guide (3 rd row)

*only for 4x4 variant

DIMENSIONS (mm)

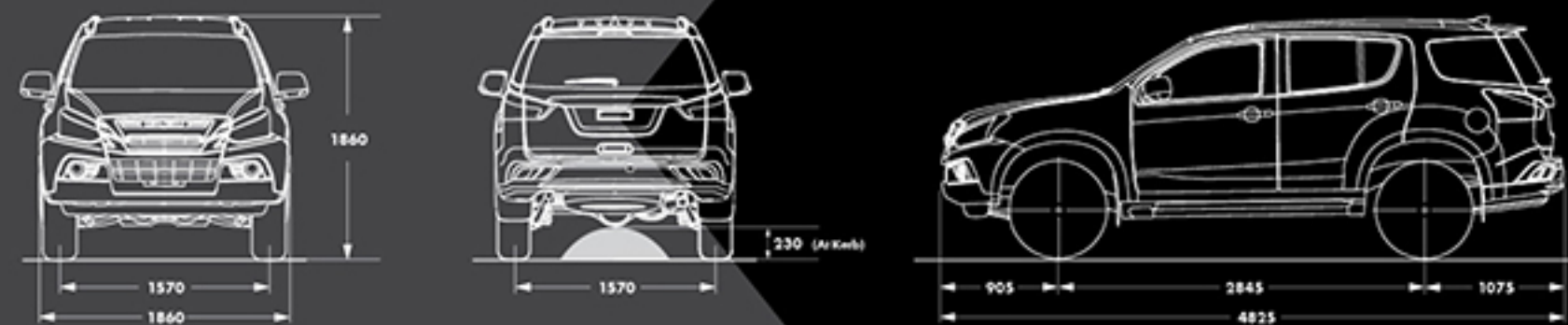

COLOURS



ISUZU SECURE

FREE SERVICE*
5 YEARS
OR 150,000 KM

WARRANTY*
5 YEARS
OR 150,000 KM

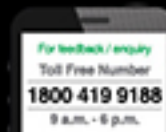

*Terms & Conditions Apply. *Isuzu Secure (warranty & free service) is valid upto 5 years/150,000 km from the date of delivery, whichever is earlier. For validity, inclusions, exclusions and other detailed terms and conditions of the ISUZU Secure offer, please contact your local authorized ISUZU dealership.

The information provided in this brochure should be regarded as accurate at the time of going to print. The product specifications/ variants/ colors shown in the brochure are subject to change and the manufacturer reserves the right to change/ modify elements of the vehicle specifications and equipment/ accessories without prior notice. The illustrations in the brochure may show equipment, accessories and colours which may not be part of Indian standard fitment. Actual vehicle colours may vary from those shown owing to limitations in printing. ISUZU muX complies with Bharat Stage IV emission norms. Date of going to print - 29th September 2018.