

JAGUAR XF



THE ART OF PERFORMANCE





BY APPOINTMENT TO
HM THE QUEEN
MANUFACTURERS OF
MOTOR VEHICLES
JAGUAR LAND ROVER LIMITED
COVENTRY



BY APPOINTMENT TO
HRH THE DUKE OF EDINBURGH
MANUFACTURERS OF
MOTOR VEHICLES
JAGUAR LAND ROVER LIMITED
COVENTRY



BY APPOINTMENT TO
HRH THE PRINCE OF WALES
MANUFACTURERS OF
MOTOR VEHICLES
JAGUAR LAND ROVER LIMITED
COVENTRY



JAGUAR

THE ART OF PERFORMANCE

Every day we push performance to its limit. Our performance. Our cars' performance.
We innovate, we engineer, we design. We master rules and then break them.
Only to push further. Past the limits of convention. This is when performance becomes art.

Jaguar. The Art of Performance.





CONTENTS

INTRODUCTION

The Concept of XF	07
XF - The Facts	08

DESIGN

Exterior Principles	10
Exterior Aerodynamics	12
Interior	17
Interior Space	19

PERFORMANCE

Engines	20
Automatic Transmission	22
Advanced Aerodynamics	24
Lightweight Aluminium Architecture	27
Chassis and Suspension	28
Advanced Driving Dynamics	31

DRIVING TECHNOLOGY

All Surface Progress Control	32
Torque Vectoring	34
Stability and Control	37
Head-Up Display	39

INFOTAINMENT

InControl Technologies	40
InControl Touch	43
InControl Touch Pro	45
Audio	46

SAFETY AND EFFICIENCY

Advanced Driver Assistance	48
Efficient Technologies	49

PERSONALISATION

XF - Your Choice	50
Choose your Engine	52
Choose your Model	54
Choose your Options	56
Choose your Colour	60
Choose your Wheels	61
Choose your Interior	62
Choose your Jaguar Accessories	70
Technical Specifications	74
Dimensions	76

JAGUAR WORLD

Jaguar Experience	78
The World of Jaguar	80
Glossary and Legal Information	82



Scan to find out more about the Jaguar XF.

VEHICLE SHOWN: XF PRESTIGE IN RHODIUM SILVER WITH OPTIONAL FEATURES FITTED
(MARKET DEPENDENT)

VEHICLES SHOWN ARE FROM THE JAGUAR GLOBAL RANGE. SPECIFICATIONS,
OPTIONS AND AVAILABILITY WILL VARY BETWEEN MARKETS AND SHOULD
BE VERIFIED WITH YOUR LOCAL JAGUAR RETAILER





INTRODUCTION

THE CONCEPT OF XF

XF builds on the success of Jaguar's most award-winning car ever. Possessing an unrivalled combination of style and substance, it delivers an utterly seductive blend of design, dynamics and refinement to create a car that offers both excitement and efficiency. All enhanced by state-of-the-art technologies that keep you safe, connected and entertained.

XF sits in the Jaguar Sedan range between XE's taut athleticism and the supreme luxury of XJ. The fusion of these outstanding Jaguar attributes is what creates XF - the most dynamic, premium business saloon of its generation.

VEHICLE SHOWN: XF S IN GLACIER WHITE WITH OPTIONAL FEATURES FITTED
(MARKET DEPENDENT)

XF - THE FACTS

An outstanding combination of advanced engineering, the latest technology and contemporary design sets XF apart.

LIGHTWEIGHT ALUMINIUM ARCHITECTURE

Jaguar's Lightweight Aluminium Architecture helps to make XF lighter, stronger and 28 percent stiffer than the previous XF. It is up to 190 kg lighter than its predecessor, improving handling, performance and efficiency.

ADVANCED AERODYNAMICS

XF is capable of achieving a drag coefficient of just Cd 0.28, one of the lowest in its class. Even the underside of the car is aerodynamically designed to be as smooth as possible, while apertures in the front bumper optimise airflow through the wheel arches. XF cuts through the air, reducing wind noise for enhanced refinement and improved efficiency.

CRAFTSMANSHIP AND SPACE

Contemporary craftsmanship and a beautiful, luxurious interior with the space to stretch out and enjoy every journey. Compared with the previous XF rear knee room has increased by 24 mm, making it among the best in class. Rear legroom has increased by 15 mm and rear headroom has risen by up to 27 mm*, all adding up to greater comfort and wellbeing for passengers.

*Applicable to XFs not fitted with sunroof.

VEHICLE SHOWN: XF S IN GLACIER WHITE WITH OPTIONAL FEATURES FITTED
(MARKET DEPENDENT)

ADDED INTELLIGENCE

Innovative technologies make every drive easier and safer. XF offers Adaptive LED headlights, All Surface Progress Control, Cruise Control, Speed Limiter and Advanced Park Assist.





DESIGN EXTERIOR PRINCIPLES



DESIGN
PURITY

ADAPTIVE
LED HEADLIGHTS

VEHICLE SHOWN RIGHT: XF S IN GLACIER WHITE WITH OPTIONAL FEATURES FITTED
(MARKET DEPENDENT)

"It's about paring it down to the bare essentials. Good designers have always said less is more."
Ian Callum, Jaguar Design Director.

XF demonstrates the Jaguar principles of design purity. Strong lines radiate dynamic character and enhance its capabilities - be it improving aerodynamics, visibility, stability or safety. XF is available with adaptive LED headlights featuring Jaguar signature 'J' blade Daytime Running Lights to give XF a striking on-road presence. The quality of LED light is close to daylight, helping your eyes to distinguish objects more easily and reducing fatigue at night.



EXTERIOR AERODYNAMICS

**AERODYNAMIC
DESIGN**

At the rear, XF's tail lights feature a distinctive, Jaguar F-TYPE inspired, double roundel and intersecting horizontal detail. The LED brake lights are not only brighter than halogen bulbs, they use less energy - contributing to XF's overall drive for greater efficiency. LEDs also illuminate faster - so following drivers can react more quickly to XF's braking. Within the tail lights is a pinstripe graphic - one of XF's many exquisite finishing touches.

XF's sweeping exterior design is naturally aerodynamic. Its advanced form enhances handling, dynamics and refinement. Even the boot lid's height and pitch, as well as its overall curvature and subtle spoiler, are designed to reduce drag and increase downforce. For example, the body generates as much as 50 kg of extra downforce at 160 km/h for greater stability and helps XF maintain its connection with the road.

VEHICLE SHOWN: XF PRESTIGE IN RHODIUM SILVER WITH OPTIONAL FEATURES FITTED
(MARKET DEPENDENT)













INTERIOR



**DRAMATIC START-UP
SEQUENCE**

**CONTEMPORARY
CRAFTSMANSHIP**

Open XF's door and the Start button entices you inside. Pulsing with a heartbeat it creates an emotional connection between driver and machine. Its 72 per minute double beat is the same as a jaguar cat at rest. XF is poised, ready for action. Now push the Start button. The car awakens and its mood lighting illuminates. With perfect choreography, air vents rotate open, the JaguarDrive Selector rises smoothly, and the engine growls - all inspiring you to anticipate the drive ahead.

XF's interior offers outstanding comfort, a sense of wellbeing and a wealth of choice. The number of switches and buttons is kept to a minimum to keep the look clean and tidy, as well as making them easy to use. Whichever XF interior combination you choose, materials used are always of the highest quality. Leather and finishes are selected with the greatest care to ensure that, inside XF, everything is luxurious to the touch.

INTERIOR SHOWN LEFT AND PREVIOUS PAGE: XF S FEATURING LIGHT OYSTER/JET SEAT WITH JET UPPER FACIA WITH CONTRAST STITCH, JET CARPET AND JET HEADLINING WITH OPTIONAL FEATURES FITTED (MARKET DEPENDENT)





1. Headroom 970 mm 2. Knee room 87 mm

INTERIOR SPACE

> INCREASED REAR KNEE ROOM

The rear of XF's cabin is a destination of luxury, choice and space. Compared with the previous generation XF, rear knee room has increased by 24 mm, making it among the best in class. Rear legroom has increased by 15 mm and rear headroom has risen by up to 27 mm*, all adding up to greater comfort and wellbeing for passengers. Building on the drama of its predecessor's interior, mood lighting also enhances XF's atmosphere. With Configurable Interior Mood Lighting you'll have a choice of ten interior colours.

*Applicable to XFs not fitted with sunroof.

INTERIOR SHOWN: XF S FEATURING LIGHT OYSTER/JET SEAT WITH CONTRAST STITCH, JET CARPET AND JET HEADLINING WITH OPTIONAL FEATURES FITTED (MARKET DEPENDENT)

PERFORMANCE ENGINES

INGENIUM ENGINES

XF offers a choice of refined, efficient diesel or petrol engines – all delivering a dynamic driving experience and responsive Jaguar performance. XF's engines are equipped with smart regenerative charging – harvesting kinetic energy while braking to charge the battery – for maximum economy, especially during urban driving.



DIESEL ENGINE UP TO

0-100 km/h in 8.1 s

XF is offered with the new Ingenium 2.0 I 4-cylinder Turbocharged Diesel engine. Ingenium is Jaguar Land Rover's new breed of engine designed for effortless performance, refinement and efficiency. With advanced technology and all-aluminium construction, Ingenium delivers impressive fuel consumption and CO₂ emissions. Up to 20 kg lighter than equivalent previous generation engines, Ingenium is intrinsically more efficient. And intelligent too – computer controlled, adaptive engine cooling only engages as required. The latest generation variable geometry turbocharger maximises peak power for low speed torque and responsiveness that is uniform, progressive and avoids lag.



PETROL ENGINE UP TO

0-100 km/h in 7.0 s

XF's 4-cylinder petrol engines offer power and responsiveness throughout the rev range, while improving efficiency. The 2.0 l 4-cylinder Turbocharged Petrol engine achieves '6-cylinder' levels of performance and refinement, from a more compact and economical structure.

AUTOMATIC TRANSMISSION

EIGHT-SPEED AUTOMATIC TRANSMISSION

XF's automatic transmission is highly responsive, smooth and efficient. It delivers rapid shifting for effortless acceleration and overtaking. The intelligent, adaptive system subtly changes the way the throttle delivers power, as well as gearshift patterns, to suit each particular driving circumstance. Featuring a contemporary Rotary Selector, the unique JaguarDrive Control offers even quicker shifts and sportier kickdown in Dynamic Mode, and earlier up-shifts in Eco Mode. With the automatic transmission the driver can opt to manually control gearshifts, via steering wheel paddles, at the touch of a finger.



P R N D

ADVANCED AERODYNAMICS



LOW DRAG

| Cd 0.28

XF's form has been rigorously optimised for aerodynamic efficiency and stability at motorway speeds. With a drag coefficient as low as Cd 0.28, XF cuts through the air – reducing fuel consumption and lowering emissions. Every element exploits the exterior's maximum aerodynamic potential while preserving XF's stunning proportions. Vertical apertures in the front bumper outer edges channel air through vents in the wheel arches and out over the front wheels. The airflow then passes along XF's sides where the doors have a flatter cross sectional profile to minimise air pressure differences and contribute further to reduced drag. Even the extensive under body protection is designed to make XF as efficient, economical and refined as possible.

VEHICLE SHOWN: XF PORTFOLIO IN BLACK BERRY WITH OPTIONAL FEATURES FITTED (MARKET DEPENDENT)





LIGHTWEIGHT ALUMINIUM ARCHITECTURE

 **STRONG** | **RIGID** | **75 % ALUMINIUM**

Jaguar has been at the forefront of aluminium car construction for more than a decade. Our latest innovation is Lightweight Aluminium Architecture, which is significantly lighter, stronger and 28 percent stiffer than the structure used in XF's predecessor. Aluminium has also been used to form the body sides, bonnet and front wings of XF. Lightweight aluminium panels are bonded together with a super-strong adhesive, then punched with zinc-coated, boron steel rivets that compress the adhesive to form an airtight bond and a phenomenally strong, rigid structure. This cutting edge process, coupled with the Lightweight Aluminium Architecture, contributes towards a weight saving of up to 190 kg over the previous generation XF.

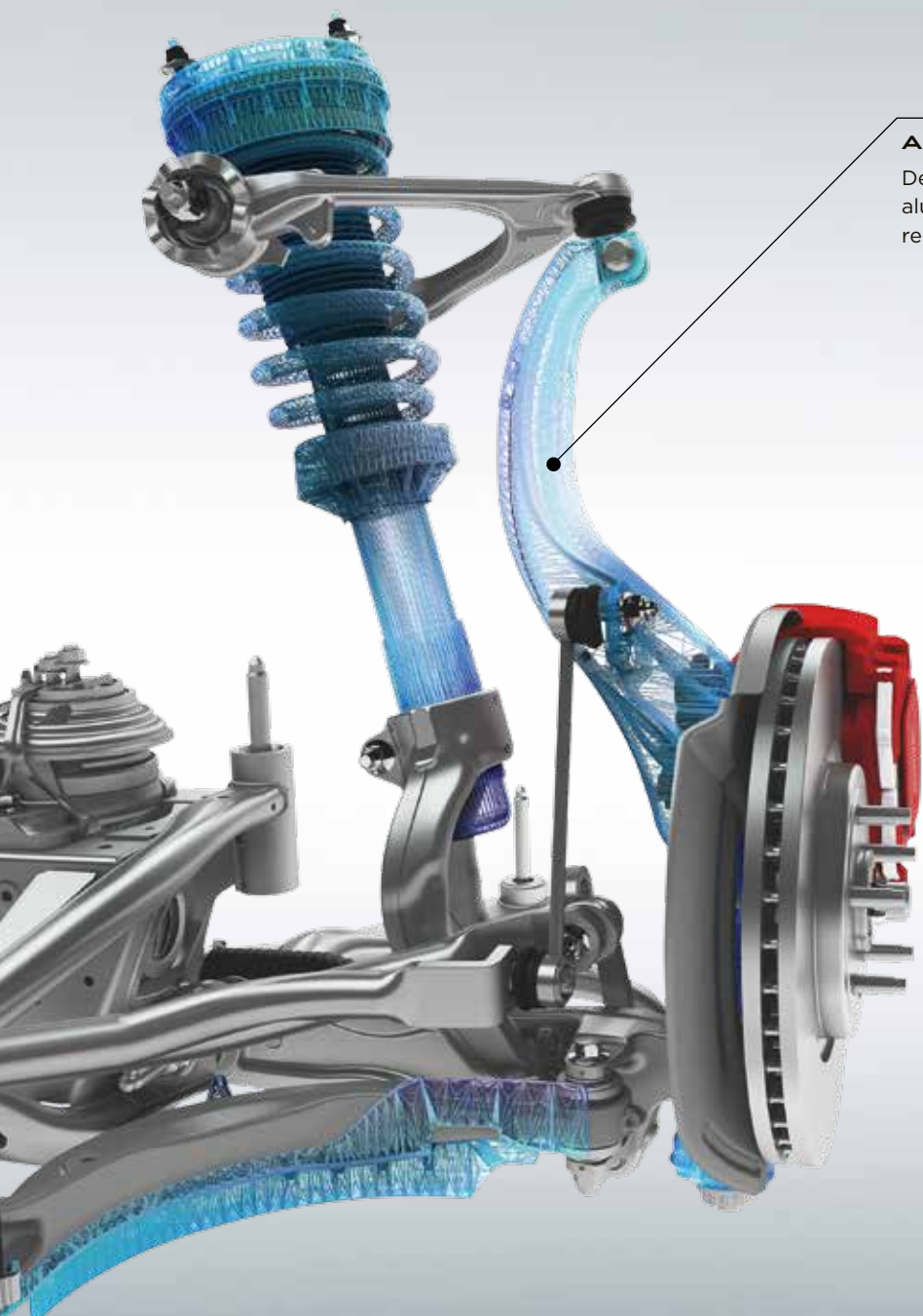

ALUMINIUM FRONT KNUCKLE

Designed to optimise stiffness and strength, the lightweight aluminium front knuckle helps improve XF's agility, responsiveness and refinement for sports car-like control.

CHASSIS AND SUSPENSION



UNIQUE SUSPENSION
TECHNOLOGY

COMFORTABLE
AND DYNAMIC

XF responds with agility and performs with dynamism while always maintaining ride comfort - it's a unique balance that makes it a Jaguar. The ideal foundation for these driving dynamics is XF's light, yet exceptionally strong and stiff, Lightweight Aluminium Architecture with its near 50:50 weight distribution.

The sophisticated front and rear suspension systems complete a chassis that achieves a superb combination of sportiness and refinement.

INTEGRAL LINK REAR SUSPENSION

Integral Link suspension allows XF to realise a perfect combination of a refined, luxurious ride and sharp, responsive handling. The system, the benchmark for this class of car, separates and independently manages the lateral, longitudinal and vertical forces acting on the suspension for enhanced control and comfort. Many components are forged or hollow-cast in aluminium – the optimum production techniques for strong, lightweight suspension.

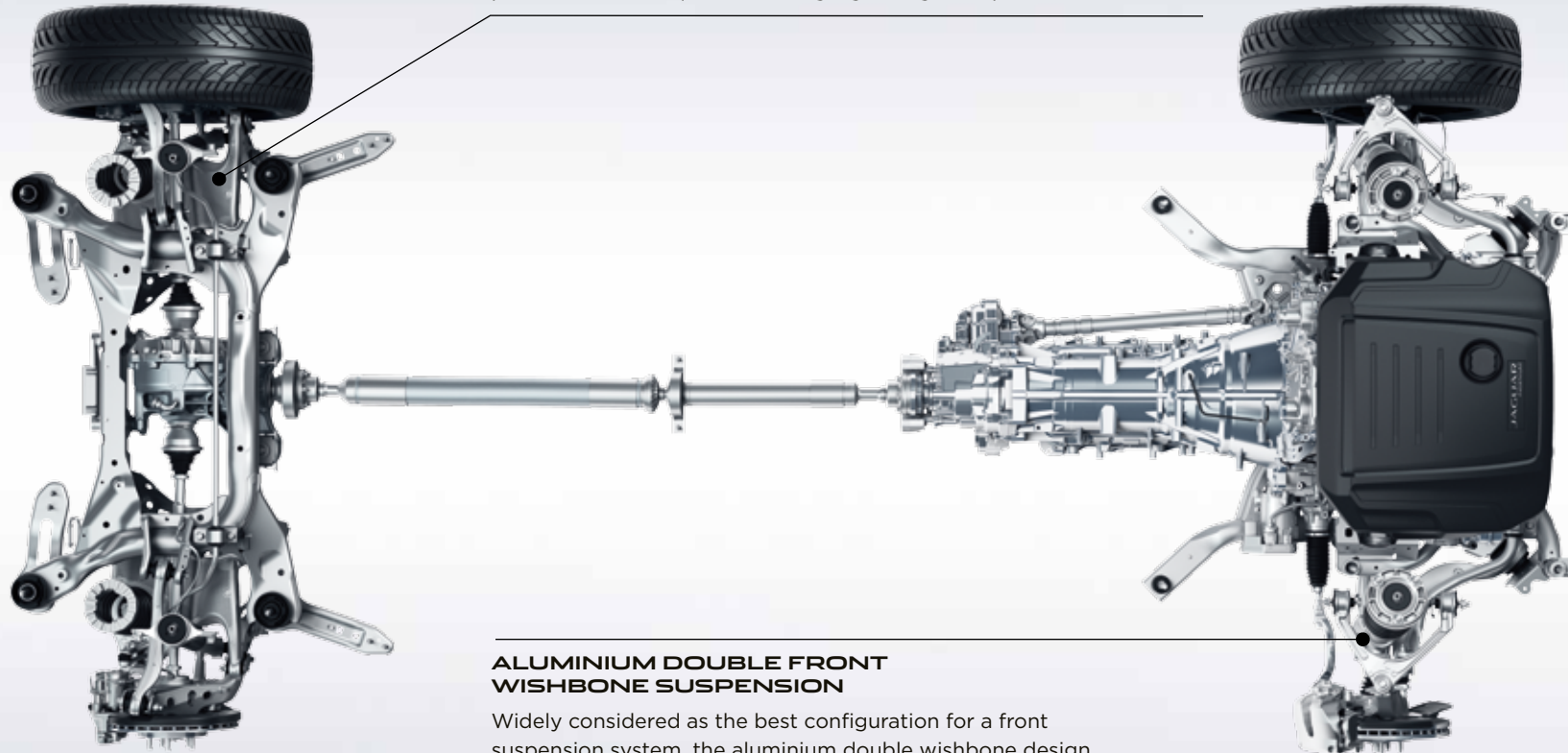

ALUMINIUM DOUBLE FRONT WISHBONE SUSPENSION

Widely considered as the best configuration for a front suspension system, the aluminium double wishbone design is modelled closely on F-TYPE's for precise handling and steering response.



ADVANCED DRIVING DYNAMICS

 MAXIMISING AGILITY

ELECTRIC POWER ASSISTED STEERING

XF's next generation Electric Power Assisted Steering (EPAS) offers outstanding feedback, control and immediate power assistance. It is active on demand - saving power for when you really need it, as well as saving fuel. Allowing sophisticated computer management to adapt the levels of steering support, EPAS gives you fine control at speed and comprehensive assistance during slow manoeuvring. It also enables advanced optional safety features such as Park Assist.

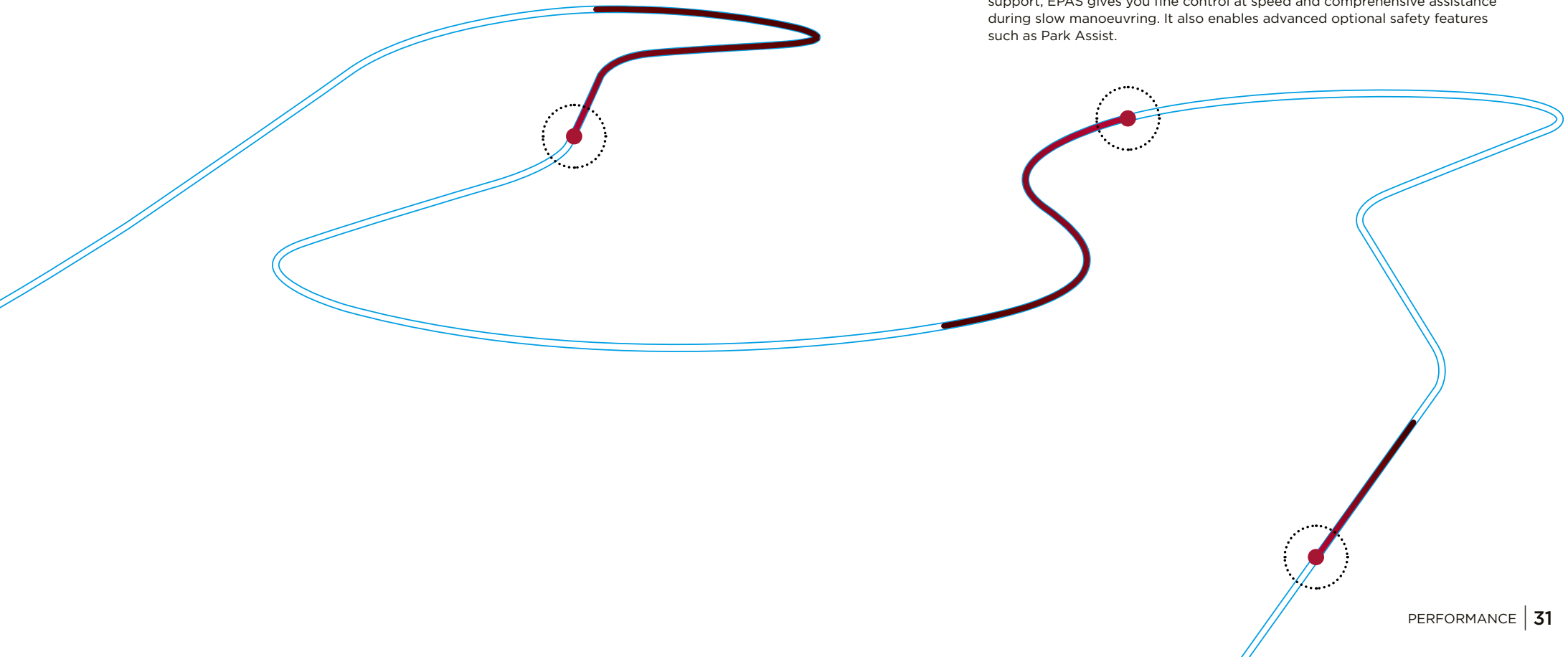

DRIVING TECHNOLOGY

ALL SURFACE PROGRESS CONTROL

 **ADDED DRIVER CONFIDENCE** | **LOW SPEED CRUISE CONTROL**

Unique in this class of car, Jaguar's All Surface Progress Control (ASPC) technology is a low speed cruise control that helps XF to cope with low traction situations. ASPC allows the driver to concentrate on steering the vehicle. Once activated, you use the cruise control buttons to set a 'target' speed of between 3.6 km/h and 30 km/h. The system then works to achieve and maintain that speed while exerting optimum traction control.

ASPC is standard on all engines fitted with automatic transmissions and gives XF drivers added confidence over slippery, loose surfaces, undulating terrain and even while descending a difficult incline. It helps make XF easy to drive in challenging conditions. ASPC also has a pull-away function allowing XF to progress from rest on slippery surfaces and ascending gradients, as well as a hill descent function that controls vehicle speed on steeper inclines.



GRAVEL



WET GRASS



SNOW/ICE



WET ROAD

TORQUE VECTORING APPLIES BRAKE PRESSURE TO SLOW THE INSIDE FRONT AND INSIDE REAR WHEELS INDEPENDENTLY.

TORQUE VECTORING

MAXIMISED CORNERING CAPABILITY

XF's Torque Vectoring by braking maximises capability through even the tightest corners. Torque Vectoring technology provides controlled independent braking on the individual inside front and rear wheels to add to the turning forces acting on the car. In most conditions more braking pressure is applied to the rear inside wheel as this supports the most increased cornering capability, while the front inside wheel is braked for greater effectiveness and refinement. The result is reduced understeer for sharper turning and more consistent road holding. Torque Vectoring delivers increased sports car-like agility and added driver confidence.

POWER IS SUSTAINED TO MAINTAIN CONSTANT SPEED OF OUTER WHEELS.

ADDITIONAL ROTATIONAL FORCE APPLIED AROUND VEHICLE'S AXIS.

VEHICLE SHOWN: XF PRESTIGE IN RHODIUM SILVER WITH OPTIONAL FEATURES FITTED (MARKET DEPENDENT)





JAGUAR

473 CAS

XF

2014

STABILITY AND CONTROL



DYNAMIC STABILITY CONTROL

ENGINE DRAG TORQUE CONTROL

Jaguar's Stability Systems keep XF safely balanced whether you're driving enthusiastically or simply want the assurance of a car that will remain stable in challenging conditions.

Dynamic Stability Control (DSC) monitors XF's dynamic behaviour, intervening to maximise vehicle stability and optimising available grip. DSC reduces engine torque and applies braking to the appropriate wheels to correct the car's direction of travel by counteracting understeer or oversteer. XF's DSC system has enhanced understeer control to reduce speed and regain control more effectively.

Engine Drag Torque Control (EDC) mitigates the chance of wheel lock-up caused by strong engine braking in slippery conditions. It acts by briefly increasing torque to the wheels as appropriate.

BRAKING APPLIED TO APPROPRIATE WHEELS TO COUNTERACT UNDERSTEER/OVERSTEER

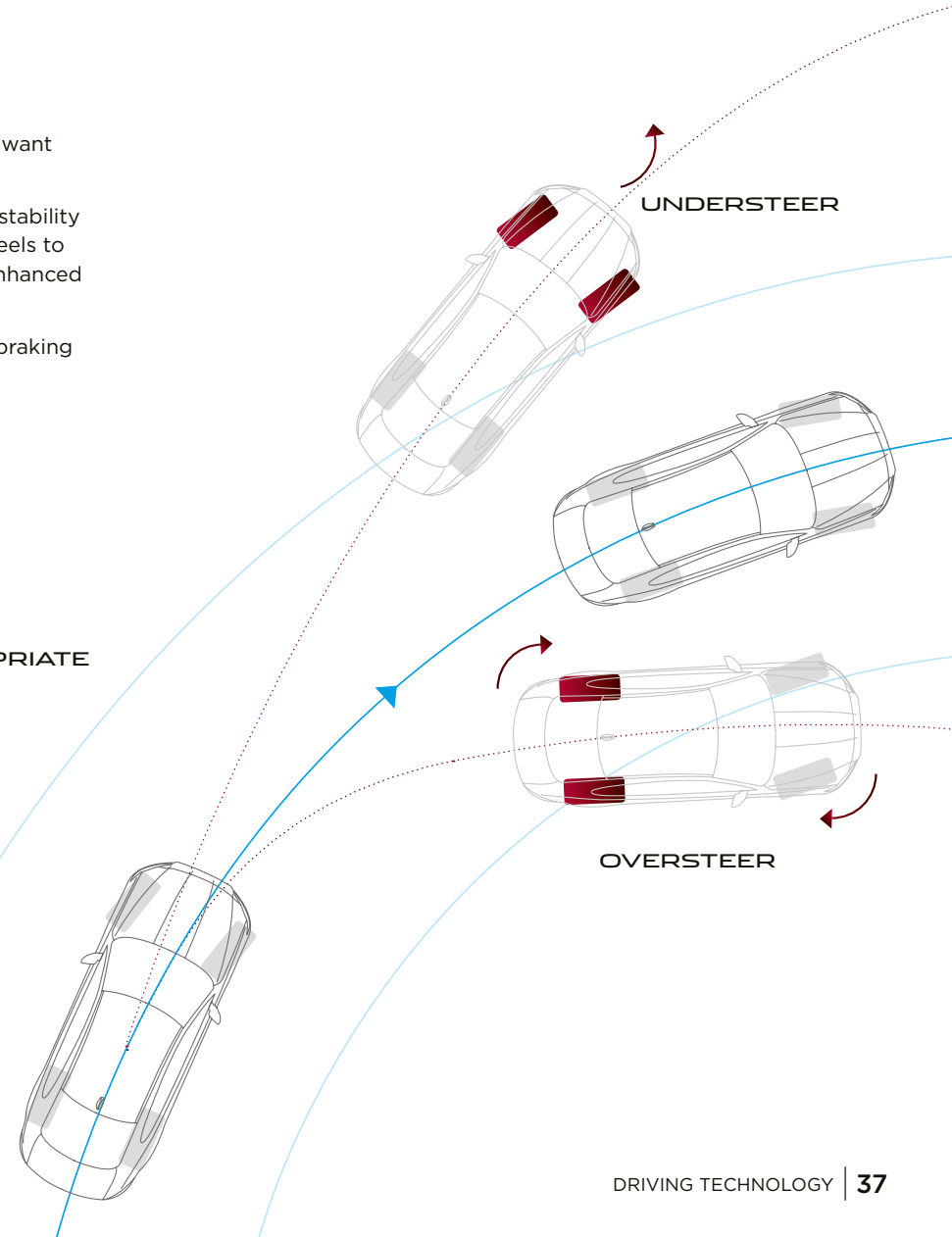

VEHICLE SHOWN: XF R-SPORT IN AMMONITE GREY WITH OPTIONAL FEATURES FITTED



HEAD-UP DISPLAY

> HEAD-UP DISPLAY WITH LASER TECHNOLOGY

The Head-Up Display (HUD) with laser technology projects key information onto the windscreen. Remaining clear even in direct sunlight, the crisp, bright image can display vehicle speed, navigation and cruise control notifications where available. This technology helps you minimise time spent looking down at the instrument cluster and can help you maintain continuous awareness of the car's speed.



NAVIGATION TURN-BY-TURN GUIDANCE

SPEED

INFOTAINMENT INCONTROL TECHNOLOGIES

 INCONTROL TOUCH | INCONTROL TOUCH PRO

InControl is our suite of advanced technologies that links both you and your XF to the wider world. Choose from two InControl infotainment systems: InControl Touch or upgrade to InControl Touch Pro.

*Supports compatible music players.
Third Party programmes or applications may require an end user licence from the supplier.



INCONTROL TOUCH



STANDARD ON XF PURE

- 20.32 cm (8) Touch-screen
- 12.70 cm (5) instrument panel display with analogue dials
- Jaguar Sound System (80 W)
- FM Radio
- USB*, Bluetooth® and AUX connections
- InControl Touch SD Navigation

ADDITIONAL FEATURE ON XF PRESTIGE

- Meridian Sound System (380 W)



INCONTROL TOUCH PRO



STANDARD ON XF PORTFOLIO

- 25.91 cm (10.2) Touch-screen with multi-touch gestures and customisable homescreen
- 31.24 cm (12.3) instrument panel display with virtual dials and full screen 3D Map View
- InControl Touch Pro Solid State Drive (SSD) Enhanced Navigation
- Meridian Digital Sound System (825 W)
- FM Radio, Bluetooth® and 2 x USB* connections
- 10 GB of onboard dedicated media storage
- CD/DVD Drive



20.32 cm [8] TOUCH-SCREEN SHOWN AT ACTUAL SIZE

Audio	XF Pure: Jaguar Sound System (80 W) XF Prestige: Meridian Sound System (380 W)
Navigation Guidance	InControl Touch SD Navigation
Display	12.70 cm (5) instrument panel display with analogue dials
Multimedia	FM Radio*, USB*, Bluetooth® and AUX connections

*Supports compatible music players.

INCONTROL TOUCH

ADVANCED INFOTAINMENT

The InControl Touch multimedia system is XF's hub for connectivity, control and entertainment. The key features are:

20.32 cm (8) Touch-screen at the heart of the centre console. Clear and responsive graphical interface for quick control.

Easy to use Touch-screen responds directly to touch and swipe gestures.

Navigation guidance makes planning journeys and following routes easy, thanks to turn-by-turn voice guidance, junction view and 3D maps.

Bluetooth phone connectivity allows you to link and control your smartphone via InControl Touch either for phone calls or music playback: simple, easy and wire-free.

Access a world of music thanks to FM radio*, as well as USB* and AUX connections.

Precise climate control is available via the Touch-screen. Adjust temperature levels, direction and intensity of airflow.



25.91 cm [10.2] TOUCH-SCREEN SHOWN AT ACTUAL SIZE

Audio	XF Portfolio: Meridian Digital Surround Sound System (825 W)
Navigation Guidance	InControl Touch Pro SSD Enhanced Navigation
Display	31.24 cm (12.3) instrument panel display with virtual dials and full screen 3D Map View
Multimedia	FM Radio, Bluetooth® and 2 x USB* connections, 10 GB of usable memory and CD/DVD Drive

*Supports compatible music players.
Please consult your local Jaguar retailer for further details.



31.24 cm (12.3) Virtual Instrument Display with four graphical themes

INCONTROL TOUCH PRO

UPGRADE TO NEXT GENERATION INFOTAINMENT

InControl Touch Pro's next-generation hardware and software advances XF's connectivity and entertainment to the very highest level. InControl Touch Pro's features replace or enhance those found in InControl Touch. The key aspects of InControl Touch Pro are:

Larger, highly-responsive, 25.91 cm (10.2) Touch-screen at the heart of the centre console with customisable home screen and lightning fast response times. Its interactive side panel makes multi-tasking easy.

Pinpoint touch control allows you to manipulate and interact with information swiftly and seamlessly. The Touch-screen responds in the same manner as a smartphone or tablet computer, providing multi-touch gestures such as pinch to zoom and swipe.

31.24 cm (12.3) Instrument Panel Display with Virtual Dials and full screen 3D Map View makes driving even more of a pleasure. It is housed in the instrument display directly in front of the driver. Select full screen 3D Map View or choose one of four graphical themes to suit your personal preference.

Enhanced Navigation with response times that are a fraction of conventional systems'.

Personal media storage of 10 GB of usable memory for your music and movies. 'Plug and play' using the two USB ports allowing for fast transfer speeds.

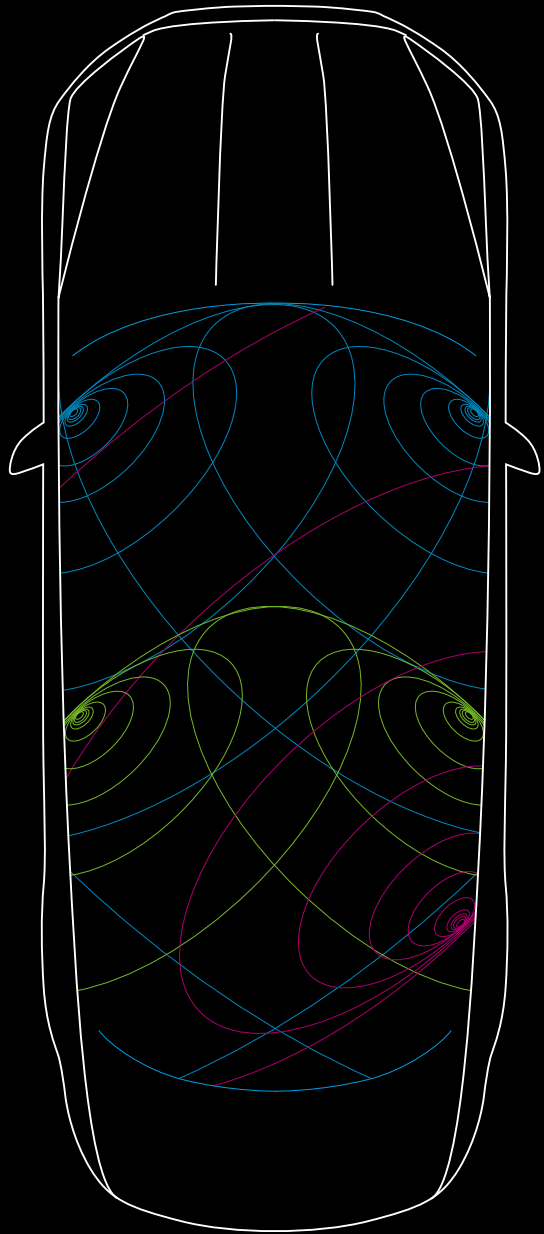

AUDIO

 **JAGUAR
SOUND SYSTEM**

**MERIDIAN
SOUND SYSTEMS**

XF's superb sound systems bring your music to life. The Jaguar Sound System provides acoustic range through eight speakers. Offering an enhanced listening experience are the optional Meridian Sound Systems. Designed in conjunction with the British audio experts Meridian, these systems use innovative audio technology and precise speaker placement to give perfectly optimised sound quality.

Choose from a range of sound systems, including the new 380 W Sound System with 11 speakers or the digital 825 W Surround Sound System with 17 speakers. All ensure that, wherever you or your passengers sit in your XF, everyone will enjoy a rich, enveloping audio experience.



-  Fresh air subwoofer
-  Front door waves tweeter midrange bass
-  Rear door waves tweeter midrange

Diagram representative of Meridian 380 W Sound System.



MERIDIAN

SOUND SYSTEMS AVAILABLE IN CONJUNCTION WITH **INCONTROL TOUCH**

XF Pure

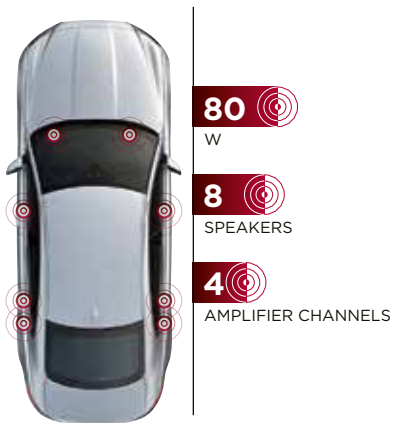

JAGUAR SOUND SYSTEM

80 W
8 speakers
4 amplifier channels

XF Prestige

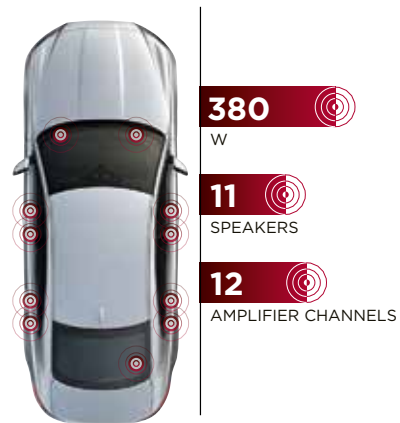

MERIDIAN SOUND SYSTEM

DSP amplifier
380 W
11 speakers
12 amplifier channels

SOUND SYSTEMS AVAILABLE IN CONJUNCTION WITH **INCONTROL TOUCH PRO**

XF Portfolio

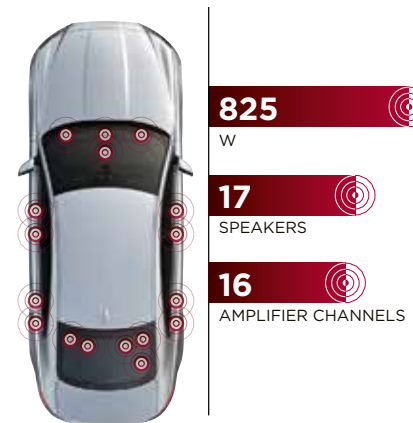

MERIDIAN DIGITAL SURROUND SOUND SYSTEM

DSP amplifier
Audyssey MultEQ Audio Equalisation
825 W
17 speakers
16 amplifier channels

VEHICLE SHOWN: XF PRESTIGE IN RHODIUM SILVER WITH OPTIONAL FEATURES FITTED (MARKET DEPENDENT)

SAFETY AND EFFICIENCY ADVANCED DRIVER ASSISTANCE

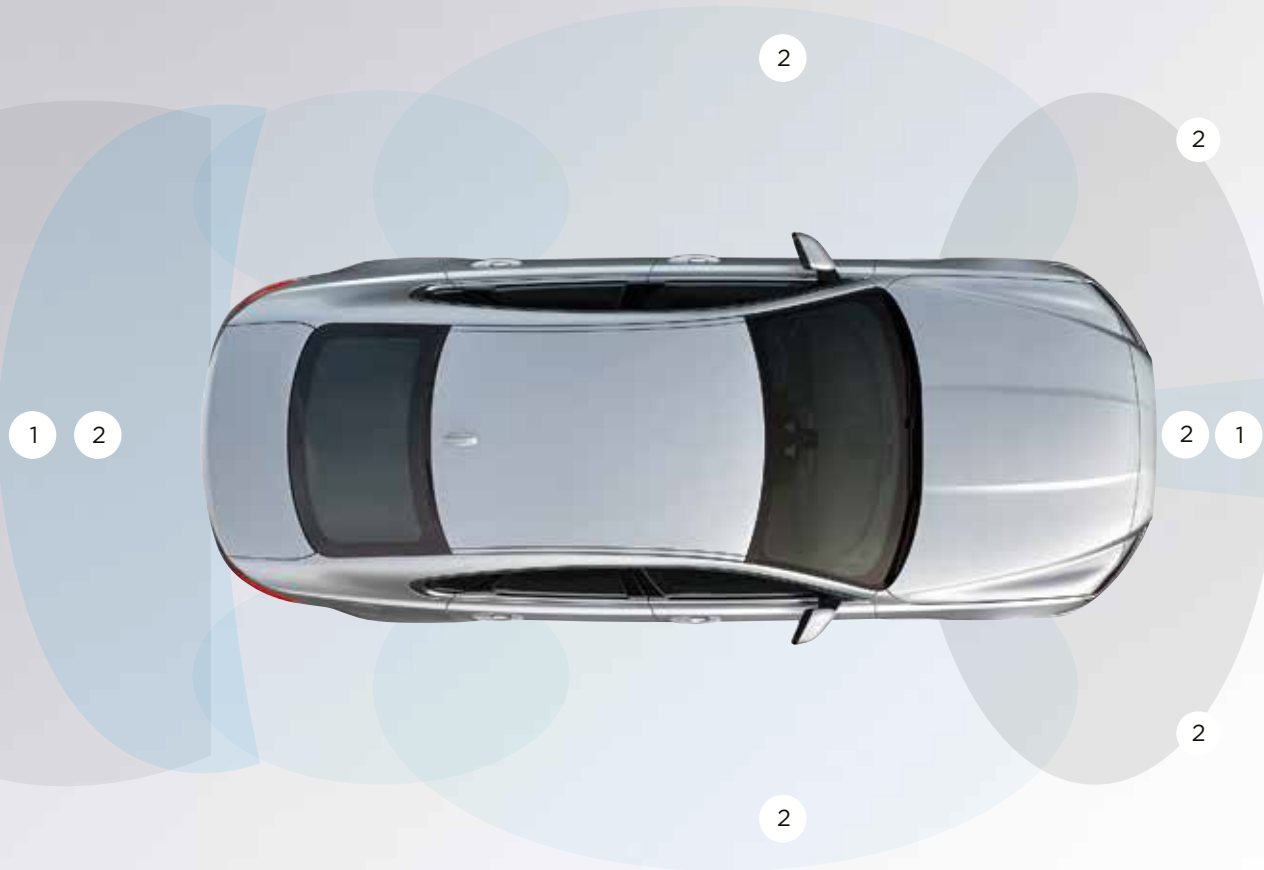

- ① **PARK ASSIST**
Park Assist makes parking in tight spaces easier than ever. XF can accurately steer itself during both parallel and bay parking manoeuvres – the driver only has to control the brakes and accelerator. An exit-assist function can help guide XF while leaving a parallel space.

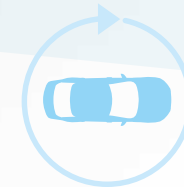

- ② **SURROUND CAMERA SYSTEM**
Surround Camera System gives you 360° exterior vision on the Touch-screen. This helps with various manoeuvres from parking by a kerb to getting in and out of tight spaces and junctions.

Graphical representation only.

VEHICLE SHOWN: XF PRESTIGE IN RHODIUM SILVER WITH OPTIONAL FEATURES FITTED (MARKET DEPENDENT)

EFFICIENT TECHNOLOGIES



LOW FRICTION

CLEAN TECHNOLOGIES

Everyone wants to do more with less. That is why XF uses a range of technologies to reduce fuel consumption and CO₂ emissions, all while staying true to Jaguar's dynamic nature.



43.18 cm [17] ALLOY WHEELS

XF is available with a lightweight wheel, with Ultra Low Rolling Resistance tyres to maximise efficiency without loss of Jaguar's legendary comfort.



ADVANCED AERODYNAMICS

XF can offer an incredibly low drag coefficient of Cd 0.28, matching the best of its rivals. This helps XF cut through the air with ease, meaning less work for the engine and therefore reduced fuel consumption and emissions.

PERSONALISATION XF - YOUR CHOICE

 Configure your vehicle at jaguar.in



CHOOSE YOUR ENGINE

Page 52

Select one of XF's powerful, efficient petrol or diesel engines to suit your driving style.

CHOOSE YOUR MODEL & OPTIONS

Page 54

Compare the wealth of standard features and options on XF models.

CHOOSE YOUR COLOUR

Page 60

Express your individuality with one of XF's stunning exterior colours.



CHOOSE YOUR
WHEELS

Page 62

Add the personal finishing touch to your new XF, and complement its stunning style, with a set of beautifully designed alloy wheels.



CHOOSE YOUR
INTERIOR

Page 63

There's a wide selection of premium materials, leathers, veneers and finishes for every personal taste.



CHOOSE YOUR
**JAGUAR
ACCESSORIES**

Page 72

Really make it yours by adding style, practicality and versatility with official XF Accessories from your local Jaguar retailer.

1 CHOOSE YOUR ENGINE

 Configure your vehicle at jaguar.in

> DIESEL ENGINE

2.0 I

4-CYLINDER TURBOCHARGED

MAXIMUM POWER* 132 kW

MAXIMUM TORQUE* 430 Nm

ACCELERATION 0-100 km/h
Automatic 8.1 s

TOP SPEED Automatic 229 km/h

CARBON DIOXIDE EMISSIONS* 142.502 g/km

PURE, PRESTIGE & PORTFOLIO



AUTOMATIC
0-100 km/h



AUTOMATIC
TOP SPEED km/h

*All Figures are certified by ARAI, the Indian Homologation Authority.

A vehicle's actual fuel consumption may differ from that achieved in such tests and these figures are for comparative purposes only.

> PETROL ENGINE

2.0 I

4-CYLINDER TURBOCHARGED

MAXIMUM POWER* 177 kW

MAXIMUM TORQUE* 340 Nm

ACCELERATION 0-100 km/h 7.0 s

TOP SPEED 248 km/h

CARBON DIOXIDE EMISSIONS* 180.749 g/km

PRESTIGE, PORTFOLIO



0-100 km/h



TOP SPEED km/h

2 CHOOSE YOUR MODEL

 Configure your vehicle at jaguar.in

LUXURY



PURE

KEY FEATURES

- 43.18 cm (17) alloy wheels
- Bi-function Xenon headlights with LED 'J' blade Daytime Running Lights
- Luxtec Seats
- 10-way electric front seats
- Gloss Black veneer
- Morse Code Aluminium instrument panel finisher
- All Surface Progress Control
- InControl Apps

Images feature optional equipment.
Please note that standard features may be replaced when selecting alternative trim levels.



PRESTIGE

KEY FEATURES

- 10-way electric front seats
- Gloss Burr Walnut Veneer
- Perforated Taurus Leather seats
- Rear armrest with cupholders
- Soft grain leather steering wheel
- Carpet mats
- Interior Mood Lighting
- 4-way electric lumbar adjust
- InControl Apps



PORTFOLIO

KEY FEATURES (IN ADDITION TO PRESTIGE)

- Perforated Windsor Leather seats
- Windsor leather instrument panel finisher
- Gloss Figured Ebony veneer
- 14-way electric front luxury seats
- LED headlights with LED 'J' blade Daytime Running Lights

2 CHOOSE YOUR OPTIONS

 Configure your vehicle at jaguar.in

KEY STANDARD FEATURES		PURE	PRESTIGE	PORTFOLIO	DESCRIPTION
Hill Launch Assist		●	●	●	Prevents your XF from rolling backwards when pulling away on an incline, helping you to make the perfect hill start every time
JaguarDrive Control with Dynamic, Normal and Winter modes		●	●	●	Refer to page 32
Electric Power Assisted Steering (EPAS)		●	●	●	Refer to page 31
Electric Park Brake with drive away release		●	●	●	Automatically releases the parking brake without the need for driver input as you press the accelerator to drive away
Emergency Brake Assist		●	●	●	Increases braking pressure in an emergency situation
Hazard lights under heavy braking		●	●	●	
Airbags		●	●	●	Driver and front passenger with seat occupant detector for passenger, front side and full length side window curtain
Torque Vectoring		●	●	●	Refer to page 37
Dynamic Stability Control and Traction Control		●	●	●	Refer to page 37
Cruise Control with Speed Limiter		●	●	●	
Electric front and rear windows with one-touch open/close and anti-trap		●	●	●	
Rain sensing windscreen wipers		●	●	●	
Two-zone climate control		●	●	●	
USB and Auxiliary socket connectivity		●	●	●	Refer to page 41
Bluetooth® streaming		●	●	●	Refer to page 41
Jaguar Smart Key System - Keyless Entry		—	—	●	
DYNAMIC FEATURES					
Eight-speed automatic transmission with Jaguar Sequential Shift, gearshift change paddles and All Surface Progress Control		●	●	●	Refer to page 22
EXTERIOR FEATURES AND FINISHERS					
EXTERIOR FEATURES AND TRIM					
Electric tilt/slide sunroof	F45C	—	●	●	
Chrome radiator grille with Chrome surround	G12V	—	●	●	
Chrome side window surround	D53C	●	●	●	

● Standard — Not available

Please consult your local Jaguar retailer for details.

EXTERIOR FEATURES AND FINISHERS CONTINUED

		PURE	PRESTIGE	PORTFOLIO	
GLASS AND EXTERIOR MIRRORS					DESCRIPTION
Infrared Reflective windscreen (front screen only)	D97B	—	—	●	Filters sunlight to reduce glare and prevent harmful UV rays from entering the cabin
Power fold exterior mirrors in body colour, heated and auto-dimming with approach lamps and clear side turn indicators (requires interior auto-dimming mirror)	B28P	●	—	—	
Power fold exterior mirrors with memory in body colour, heated and auto-dimming with approach lamps and clear side turn indicators (requires interior auto-dimming mirror)		—	●	●	
HEADLIGHTS AND LIGHTING					
Bi-function Xenon headlights with LED 'J' blade Daytime Running Lights, automatic levelling and headlight powerwash	D90L	●	● ¹	—	
LED headlights with LED 'J' blade Daytime Running Lights, adaptive lighting, turning light, Automatic High Beam Assist and headlight powerwash	D90T	—	● ²	●	
WHEELS					(Availability of wheels is subject to choice of engine, please see page 62 to see the full range)
Space saver spare wheel	C40D	●	●	●	
Tyre Pressure Monitoring System		●	●	●	
SEATING AND VENEERS					
SEATING					
10-way electric front seats	Z03V	●	●	—	
4-way electric lumbar adjust	F52A	—	●	—	
Driver Memory	H44N	—	●	—	Adjusts driver seat, mirrors and steering column
14-way electric front Luxury seats	Z03Z	—	—	●	With manual headrest height, 4-way electric lumbar adjust and Passenger and Driver Memory
40:20:40 split fold rear seat with arm rest	H48W	—	—	●	
Driver & Passenger Memory		—	—	●	
VENEERS					Please see page 64 for full range of veneers

¹Available as a standard feature on XF 2.0 I diesel Prestige.

²Available as a standard feature on XF 2.0 I petrol Prestige.

2 CHOOSE YOUR OPTIONS

 Configure your vehicle at jaguar.in

HEADLINING AND INTERIOR FEATURES

		PURE	PRESTIGE	PORTFOLIO	
HEADLINING					
Light Oyster headlining	HAMT	●	●	●	
Suede cloth headlining	H01D	—	—	●	
INTERIOR FEATURES					
Illuminated metal tread plates with Jaguar script	F28F	—	—	●	
Carpet mats	H69H	●	●	—	
Premium carpet mats	H69K	—	—	●	
Electrically adjustable steering column	D07J	—	●	●	
Auto-dimming Interior Rear View Mirror	B68B	●	●	●	
Air Quality Sensor and Cooled Glove Box	C89A, B23H	—	●	●	
Manual rear side window sunblinds	H73B	●	●	●	
Electric rear window sunblind	H76G	●	●	●	
Interior Mood Lighting	B65A	—	●	—	
Configurable Interior Mood Lighting with ten colours	B65B	—	—	●	Refer to page 19
Smoker's Pack	A03B	●	●	●	Includes single ashtray and single cigar lighter
SAFETY AND SECURITY					
Front Parking Aid	C13A	●	●	●	
Rear Parking Aid	C11A	●	●	●	
Rear View Camera	C14A	—	●	—	
Surround Camera System	C14D	—	—	●	Refer to page 48
Park Assist	C18B	—	—	●	Parallel and Perpendicular Parking
360° Parking Aid	C17A	—	●	●	
Jaguar Smart Key System - Keyless Entry	F04B	—	—	●	

● Standard — Not available

Please consult your local Jaguar retailer for details.

INFORMATION, COMMUNICATION AND ENTERTAINMENT

		PURE	PRESTIGE	PORTFOLIO	
FEATURES ONLY AVAILABLE WITH INCONTROL TOUCH					
InControl Touch with 20.32 cm (8) Touch-screen		●	●	—	Refer to page 43
12.70 cm (5) instrument panel display with analogue dials		●	●	—	Refer to page 43
InControl Touch SD Navigation	G61C	●	●	—	Refer to page 43
Jaguar Sound System (80 W)		●	—	—	Refer to page 46-47
Meridian™ Sound System (380 W)	B44V	—	●	—	Refer to page 46-47
FEATURES ONLY AVAILABLE WITH INCONTROL TOUCH PRO					
InControl Touch Pro with 25.91 cm (10.2) Touch-screen, 31.24 cm (12.3) HD Virtual Instrument Display, SSD Navigation and Meridian™ Digital Surround System (825 W)	Z59Y	—	—	●	Refer to page 45-47
InControl Apps		●	●	●	

3 CHOOSE YOUR COLOUR

 Configure your vehicle at [jaguar.in](https://www.jaguar.in)

SOLID

METALLIC

PREMIUM
PALETTE

Polaris White

Ultimate Black

Rhodium Silver

Dark Sapphire Blue

Caesium Blue

Italian Racing Red

Odyssey Red

Aurora Red

Storm Grey

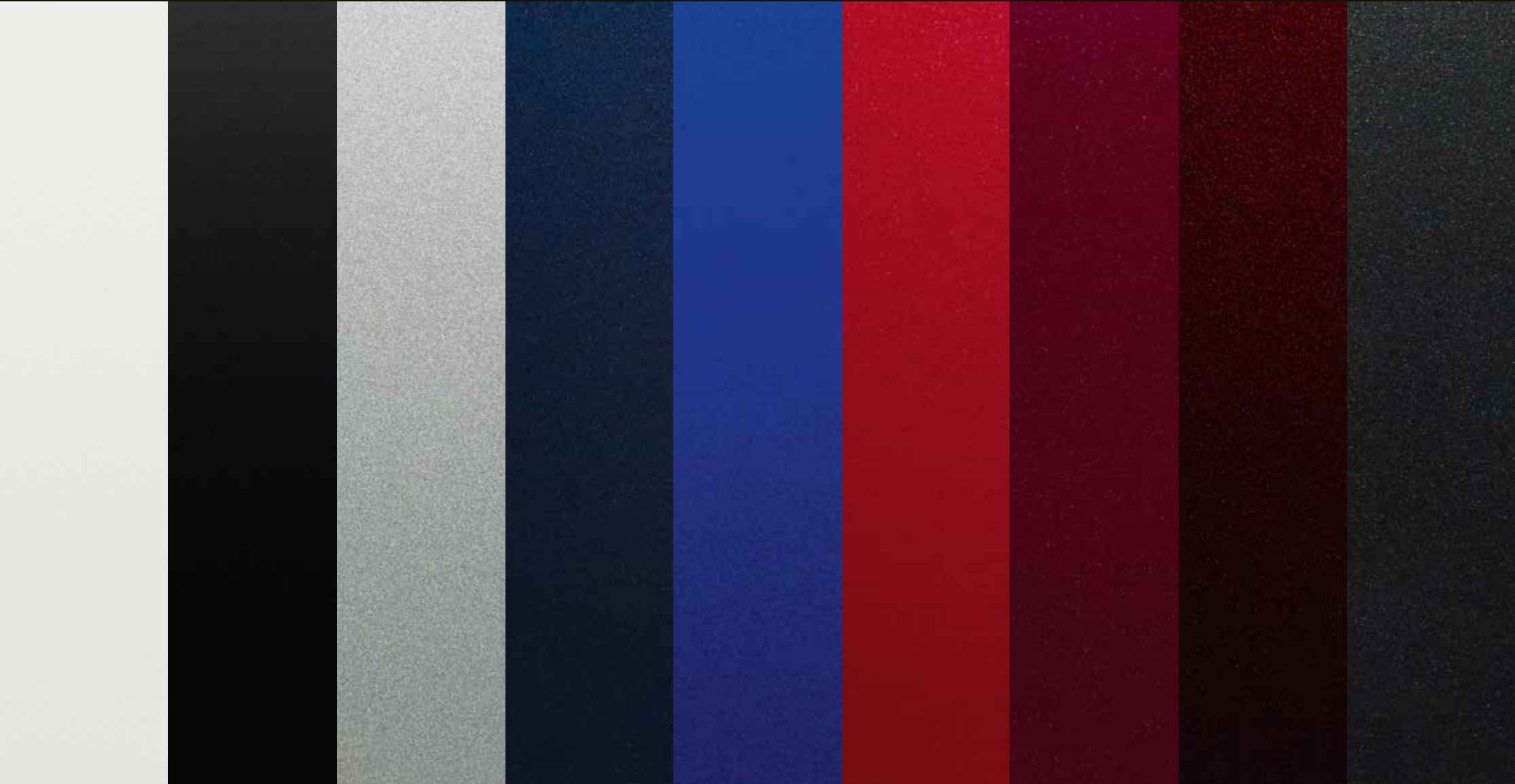

4 CHOOSE YOUR WHEELS

 Configure your vehicle at jaguar.in



43.18 cm [17]
LIGHTWEIGHT
15 SPOKE

Silver
C54B



43.18 cm [17]
TURBINE
9 SPOKE

Silver
C54C

ALLOY WHEEL FINISH
CODE

Pure
Prestige Diesel
Portfolio

●

—

—

—

●

—



45.72 cm [18]
CHALICE
7 TWIN SPOKE

Silver
C53S



45.72 cm [18]
HELIX
10 SPOKE

Silver
C53T

ALLOY WHEEL FINISH
CODE

Pure
Prestige Petrol
Portfolio

—

●

●¹

—

—

●²

● Standard ○ Option — Not Applicable

¹Portfolio Diesel.

²Portfolio Petrol.

5 CHOOSE YOUR INTERIOR

 Configure your vehicle at jaguar.in

PURE						
	SEAT WITH TONAL STITCH	UPPER FACIA WITH TONAL STITCH	INTERIOR TRIM AND OPTION CODES	HEADLINING MORZINE	CARPET	VENEER
Standard						
Luxtec seats	Latte with Latte	Espresso with Espresso	TR24	Light Oyster	Espresso	Gloss Black
PRESTIGE						
	SEAT WITH TONAL STITCH	UPPER FACIA WITH TONAL STITCH	INTERIOR TRIM AND OPTION CODES	HEADLINING MORZINE	CARPET	VENEER
Standard						
Taurus Leather seats	Jet with Jet	Jet with Jet	TR26	Light Oyster	Jet	Gloss Burr Walnut
	Latte with Latte	Espresso with Espresso	TR27	Light Oyster	Espresso	Gloss Burr Walnut
PORTFOLIO						
	SEAT WITH TONAL STITCH	UPPER FACIA WITH TONAL STITCH	INTERIOR TRIM AND OPTION CODES	HEADLINING SUEDECLOTH	CARPET	VENEER
Standard						
Windsor Leather seats	Espresso with Espresso	Espresso with Espresso	TR40	Light Oyster	Espresso	Gloss Figured Ebony
	Siena Tan with Siena Tan	Jet with Jet	TR41	Light Oyster	Jet	Gloss Figured Ebony

5 CHOOSE YOUR INTERIOR

 Configure your vehicle at jaguar.in

Gloss Black Veneer

Gloss Figured Ebony Veneer

Gloss Burr Walnut Veneer

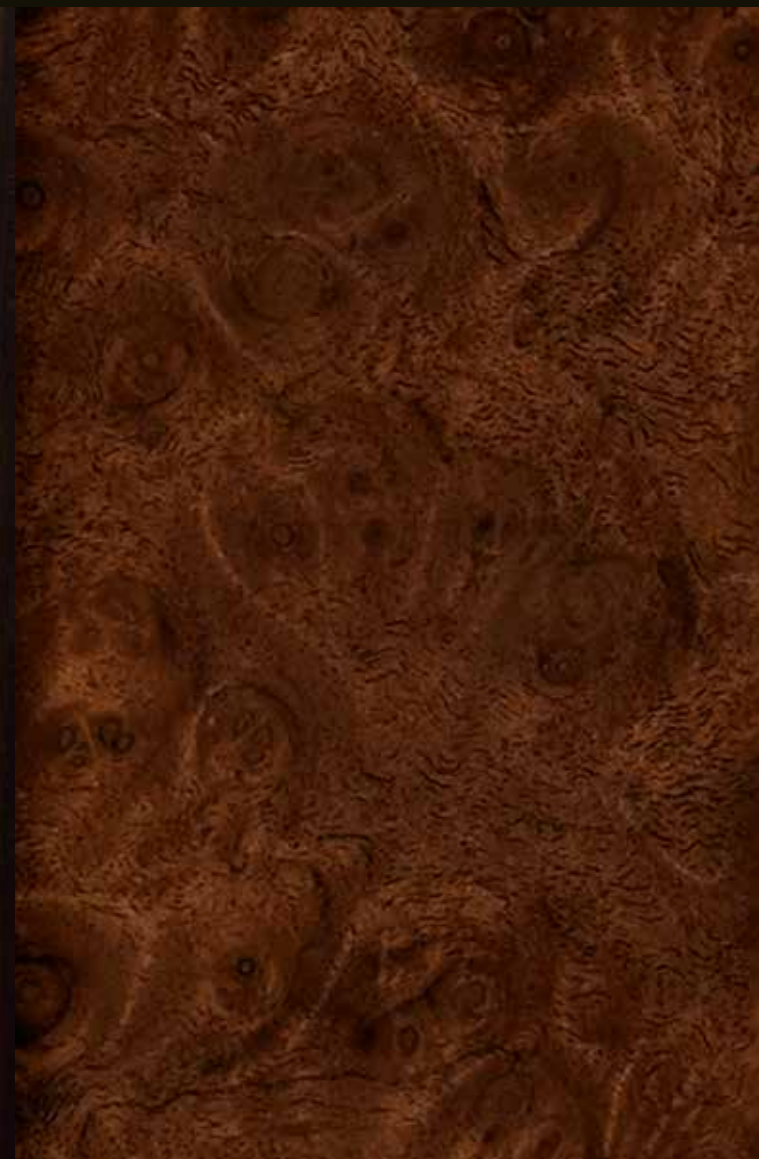

5 CHOOSE YOUR INTERIOR

⚙️ Configure your vehicle at jaguar.in

Interior shown: Jet Luxtec seats with Jet facia, Morse Code Aluminium finisher, Gloss Black veneer and optional Jet headlining.



PURE

INTERIOR COLOUR COMBINATIONS

STANDARD

1

SEAT WITH TONAL STITCH



Latte

2

VENEER



Gloss Black

3

HEADLINING MORZINE



Light Oyster

4

UPPER FACIA
WITH TONAL STITCH



Espresso with Espresso

5

FINISHER



Morse Code Aluminium

6

CARPETS



Espresso

5 CHOOSE YOUR INTERIOR

⚙️ Configure your vehicle at jaguar.in

Interior shown: Jet Taurus leather seats with Jet tonal stitch, Jet fascia, Morse Code Aluminium finisher, Optional Black veneer and optional Jet headlining.



PRESTIGE

INTERIOR COLOUR COMBINATIONS

STANDARD

1

SEAT WITH TONAL STITCH



Jet with Jet

2

VENEER



Gloss Burr Walnut

3

HEADLINING MORZINE



Light Oyster

4

UPPER FACIA WITH TONAL STITCH



Jet with Jet

5

FINISHER



Morse Code Aluminium

6

CARPETS



Jet



Latte with Latte



Gloss Burr Walnut



Light Oyster

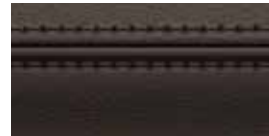

Espresso with Espresso



Morse Code Aluminium



Espresso

5 CHOOSE YOUR INTERIOR

⚙️ Configure your vehicle at jaguar.in

Interior shown: Latte Windsor leather seats with Latte tonal stitch, Espresso facia, Morse Code Aluminium finisher, Gloss Figured Ebony veneer and Light Oyster headlining.



PORTFOLIO

INTERIOR COLOUR COMBINATIONS

STANDARD

1

SEAT WITH TONAL STITCH



Espresso with Espresso



Siena Tan with Siena Tan

2

VENEER



Gloss Figured Ebony



Gloss Figured Ebony

3

HEADLINING SUEDECLOTH



Light Oyster



Light Oyster

4

UPPER FACIA WITH TONAL STITCH



Espresso with Espresso

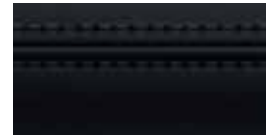

Jet with Jet

5

FINISHER



Morse Code Aluminium



Morse Code Aluminium

6

CARPETS



Espresso



Jet

6 CHOOSE YOUR JAGUAR ACCESSORIES

To find out more about the full range of retailer fit Jaguar Accessories, please refer to your retailer or go to accessories.jaguar.com



Roof Mounted Cycle Carrier*
C2A1539

An easy to fit, roof mounted, lockable cycle carrier which carries one bike per holder. A maximum of three holders can be fitted.

*Requires roof cross bars T2H14468.

VEHICLE SHOWN: XF PRESTIGE IN RHODIUM SILVER WITH OPTIONAL FEATURES FITTED (MARKET DEPENDENT)



Aluminium Paddle Shifters
T2R6547
T2R6547CAY Red

Replacement steering wheel gearshift paddles offered in a premium aluminium material providing a high quality finish to a key contact point in the vehicle. Manufactured from billet machined aluminium, the paddles are hand brushed for a premium finish and anodised to ensure they will not deteriorate with wear.



Premium Carpet Mats
T2H7171PVJ - LHD
T2H7173 - LHD AWD

Luxurious, tailored 2,050 g/m² pile front carpet mats with embossed Jaguar logo and nubuck edge binding. The premium mats provide a well appointed finishing touch to the interior.



Central Armrest Chiller/Warmer
T2H7739

Food and drinks chiller and warmer that acts as a rear centre armrest. With a leather-covered top, it is held in place by the centre seat belt and powered from the rear auxiliary socket. Ideal for long journeys with the family.



iPad Holder
T2H7757

Jaguar branded iPad® holder mounts to front seat headrests providing a flexible solution for rear seat entertainment. Quick release design ensures iPad® can be fitted or removed quickly and easily.



Personalised Illuminated Sill Tread Plates**
T2H1712PVJ

Elegantly styled stainless steel sill tread plate finishers for driver or passenger doors. Illuminates when either the driver or passenger doors are opened. Highlighted by soft Phosphor Blue lighting. Allows customer to specify a monochrome 'motif' in a choice of approved typefaces/scripts.



Rear Splash Guards
T2H12954

Jaguar branded, rear splash guards complement the lines of your vehicle and provide protection from dirt and stone chippings.

**Not available for Pure.

6 CHOOSE YOUR JAGUAR ACCESSORIES

 Configure your vehicle at jaguar.in



Gloss Black Side Vent*
T4N5176 - Left Side
T4N5178 - Right Side

Jaguar branded, Gloss Black side power vents provide a dynamic exterior styling enhancement. Left and Right side options available.



Carbon Fibre Side Vent
T2H18318 - Left Side
T2H18319 - Right Side

High grade Carbon Fibre side power vents provide a performance-inspired styling upgrade. Left and right side options available.



Lower Vent Finisher - Gloss Black
T2H4010 - For Pure, Prestige, Portfolio and S
T2H14518 - For R-Sport only

Gloss Black lower vent finishers accentuate the exterior styling cues of the XF and can be fitted with other Gloss Black exterior trim accessories.



Gloss Black Mirror Cap
C2D6067PEC - Left Side
C2D6066PEC - Right Side

Gloss Black mirror covers accentuate the dynamic design of the exterior mirrors. Left and right side options available.



Carbon Fibre Mirror Cap
C2P24176 - Right Side
C2P24177 - Left Side

High grade Carbon Fibre mirror covers provide a performance-inspired styling upgrade. Left and right side options available.



Rear Tailgate Trim - Gloss Black
T2H6925

Add style and visual distinction with Gloss Black finish rear tailgate trim.

*Not applicable for R-Sport. **Requires roof cross bars T2H14468.



Roof Cross Bars
T2H14468

Jaguar branded cross bars required for fitting all roof carrying equipment. Engineered specifically for your vehicle.



Watersports Carrier**
C2Z21730

A versatile system for transporting a variety of water sports equipment including surfboard, kayak or sailboard. Tilts to facilitate loading/unloading.



Roof Sport Box**
C2C41627

Spacious 320 l capacity lockable roof box designed for sports equipment, measuring 206 x 84 x 34 cm.



Premium Loadspace Carpet Mat
T2H7174PVJ - Space Saver NLI Variant
T2H7175PVJ - Space Saver NGI Variant
T2H7176PVJ - Non Space Saver Variant

Luxurious soft luggage mat in Jet Black with the Jaguar logo. Deep premium 2 050 g/m² pile with nubuck edging and Dove contrast stitch. For vehicles equipped with In-Control Touch Pro and fitted with space saver spare wheel OR for vehicles fitted with tyre repair kit.



Rear Spoiler
T2H6236LML

Give the XF an even more sporting look with this body coloured spoiler exterior styling upgrade. For Pure, Prestige and Portfolio Rear luggage compartment lid spoiler in primed condition for retailer painting. Spoiler is standard for R-Sport and 'S'.



Tow Bar Mounted Cycle Carrier
C2Z22695 - 2 Bike
C2Z22697 - 3 Bike

Premium tow ball mounted cycle carriers provide a convenient bike carrying solution with quick release loading attachments and secure locking mechanism. Clever design allows carrier to be tilted away from vehicle when fitted allowing access into the rear tailgate.

TECHNICAL SPECIFICATIONS

 Configure your vehicle at jaguar.in

ENGINES ¹		JAGUAR 2.0 I 4-CYLINDER TURBOCHARGED DIESEL
Capacity	cm ³	1 999
Maximum power	kW	132
r/min	r/min	4 000
Maximum torque	Nm	430
r/min	r/min	1 750 to 2 500
PERFORMANCE		AUTOMATIC
0-100 km/h	s	8.1
Top speed	km/h	229
FUEL CONSUMPTION ¹		AUTOMATIC
Carbon dioxide emissions	g/km	142.502
Tank capacity (usable)	l	66
Fuel Economy	km/l	19.33
DIMENSIONS ¹		
Overall length (with tow bar)	mm	5 067
Overall width (inc. mirrors)	mm	2 091
Overall height	mm	1 457
Wheelbase	mm	2 960
Front track	mm	1 605
Rear track	mm	1 594
Turning circle diameter (kerb to kerb)	m	11.61
Boot volume	l	505
WEIGHT ²		AUTOMATIC
Weight from	kg	1 681
Gross vehicle weight	kg	2 250
ENGINE AVAILABILITY		
Pure		●
Prestige		●
Portfolio		●

● Available — Not Available

¹Please note: All figures are certified by ARAI, the Indian Homologation Authority. A vehicle's actual fuel consumption may differ from that achieved in such tests and these figures are for comparative purposes only.

²Weights reflect vehicles to standard specifications. Optional extras increase weight.

**JAGUAR 2.0 I
4-CYLINDER 177 TURBOCHARGED
PETROL [AUTO]**

ENGINES¹

Capacity	cm ³	1 999
Maximum power	kW	177
r/min	r/min	5 500
Maximum torque	Nm	340
r/min	r/min	1 750 to 2 000

PERFORMANCE

RWD

0-100 km/h	s	7.0
Top speed	km/h	248

FUEL CONSUMPTION¹

RWD

Carbon dioxide emissions	g/km	180.749
Tank capacity (usable)	l	74
Fuel Economy	km/l	13.12

DIMENSIONS¹

Overall length (with tow bar)	mm	5 067
Overall width (inc. mirrors)	mm	2 091
Overall height	mm	1 457
Wheelbase	mm	2 960
Front track	mm	1 605
Rear track	mm	1 594
Turning circle diameter (kerb to kerb)	m	11.61
Boot volume	l	505

WEIGHT²

RWD

Weight from	kg	1 701
Gross vehicle weight	kg	2 210

ENGINE AVAILABILITY

Pure	–
Prestige	●
Portfolio	●

DIMENSIONS

Overall Width (inc mirrors) 2 091 mm

Overall Width (exc mirrors) 1 880 mm



Turning Circle
Kerb to Kerb 11.61 m



JAGUAR EXPERIENCE

There's no better way to get to know Jaguar than by taking a drive. The Jaguar Experience offers a range of unique opportunities to really find out what it feels like to get the most out of a Jaguar. Our track experiences allow you to push yourself and cars from the incredible Jaguar range to the limit. Jaguar Experience also offers the opportunity to see a Jaguar brought to life during a tour of one of our UK manufacturing facilities.

Find out more by visiting jaguar.in/experience-jaguar



BEHIND THE SCENES

Our factory tours give you the unique opportunity to experience the whole process of how our cars are brought to life - from the moulding of sheet metal to those intricate final touches. At our state-of-the-art production facilities, you'll get to see how skilled technicians and sophisticated machines work seamlessly together to perfect some of Jaguar's most breathtaking cars - from the powerful F-TYPE to the groundbreaking F-PACE performance SUV.



DRIVING EXPERIENCES

The opportunity to drive the latest Jaguar cars at their limits, or relive iconic Jaguar history, is rare. Jaguar Driving Experiences offer unique driving adventures you will never forget. Imagine yourself behind the wheel of our highest performing Jaguar models, on a private track, with a Jaguar Experience Instructor at your side. This is the Jaguar Performance Driving Academy.

Find out more at [jaguar.com/experience-jaguar/driving-experiences](https://www.jaguar.com/experience-jaguar/driving-experiences)



ICONIC EXPERIENCES

Take your driving to the next level with our international adventures facing extreme road, and off-road, conditions. Our Iconic Experiences offer journeys and challenges that will test and develop your performance driving skills. Every year, Jaguar customers and enthusiasts join us for our luxury Ice Driving Experience. The exclusive ski resort in Gstaad, Switzerland, is the perfect location to enjoy the thrill of performance driving on ice. Our Ice Driving Experience is a two-day getaway held each winter. You can get a flavour of the event below. Then, if you'd like to be part of it in the next experience, we can keep you posted.

Find out more at [jaguar.com/experience-jaguar/iconic-experiences](https://www.jaguar.com/experience-jaguar/iconic-experiences)

THE WORLD OF JAGUAR

Choose an XF and you're joining the exciting World of Jaguar. It makes owning and driving carefree and easy, as well as providing a range of exclusive services and lifestyle products.



GENUINE PARTS

Jaguar Genuine Parts are designed, tested and manufactured to our uncompromising standards for quality, fit and durability. Each part is engineered specifically for your XF to contribute to optimum performance and to help maximise its lifespan.



FLEET & BUSINESS

Jaguar is dedicated to being the premium manufacturer of choice for fleets and businesses by providing a highly attractive car range and exemplary customer service. Jaguars are dynamic and distinctive cars that help companies express the unique character and personality of their business. We are committed to providing totally customer-focused aftersales services, which keeps every Jaguar car on the move and in top condition, ensuring that they perform to the highest standard and in the most cost-efficient way for businesses. Visit jaguar.in for more information.



JAGUAR FINANCIAL SERVICES

Effortless performance and style come as standard with every Jaguar. Jaguar Financial Services makes buying one just as simple and rewarding. New or used, for personal or business use, we have an option that puts you in complete control. Please speak to your local Jaguar retailer to find out more.



JAGUAR ASSISTANCE

Jaguar Assistance provides assistance in motoring emergencies, from immobilisation due to breakdown or accident to minor problems such as punctures. You can rely on our roadside assistance, whatever the situation, wherever you happen to be.



JAGUAR MAGAZINE

Jaguar Magazine is the official magazine of Jaguar Cars. It features the new Jaguar F-PACE, F-TYPE, XJ, XE and XF, and the worlds of luxury, style, design and travel.

JAGUAR COLLECTION

The latest range from the Jaguar Collection has been crafted with the same design execution and attention to detail that goes into all of our cars. This is evident in our clothing range, premium leather items and luxury travel goods. To celebrate Jaguar's heritage we also have a collection that honours past achievements and features race inspired gift items and apparel. To find out more, visit the online shop at jaguar.in/branded-goods

GLOSSARY

A

ADAPTIVE FULL LED HEADLIGHTS

Adaptive Headlights automatically adjust to follow steering inputs, casting light where needed. They will angle the beam when indicating, as well as working in conjunction with Automatic High Beam Assist to prevent your lights from dazzling oncoming traffic.

ADVANCED PARK ASSIST

Advanced Park Assist offers all the functions of Park Assist (see pg. 50) plus 360° Park Distance Control with virtual object tracking. This gives confidence in confined situations, at speeds up to 16 km/h.

AUX CONNECTION

Auxiliary (AUX) connections allow for the convenient input of audio signals from personal devices.

C

Cd

The Cd value is the drag coefficient of the car. It gives an indication of the vehicle's aerodynamic qualities. The lower the value, the more aerodynamically efficient the vehicle's design.

CONFIGURABLE INTERIOR MOOD LIGHTING

Configurable Interior Mood Lighting highlights a number of your Jaguar's key functional and styling features and allows adjustment of the ambient light. Choose from a range of 10 colours.

D

DAMPERS/DAMPING

Dampers absorb forces acting on the suspension for greater ride comfort and control. Dampers are also known as shock absorbers.

DEAD RECKONING

Dead Reckoning uses sensors to measure vehicle direction, wheel rotation and inclination. These measurements are calibrated up to 40 times per second to ensure accurate placement of the vehicle even when no GPS signal is available.

DRAG COEFFICIENT

The drag coefficient measures how aerodynamic a car is. See definition of Cd.

E

ECO MODE

Eco Mode encourages fuel efficient driving by reducing throttle sensitivity, selecting more economical engine mapping and, on manual vehicles, advising of gearshifts. It also reduces fuel consumption by reducing the energy demands placed on the engine by climate control and audio systems.

F

FOUR-ZONE CLIMATE CONTROL

Automatic four-zone climate control that can be optimised for individual occupants.

G

GPS

The Global Positioning System (GPS) uses satellites to determine the car's position. By cross-referencing this with road maps stored in its memory, the navigation system provides route guidance and tracks the car's location.

I

INGENIUM ENGINES

Ingenium engines are manufactured in the UK at Jaguar Land Rover's state-of-the-art Engine Manufacturing Centre in the West Midlands. The aluminium engines feature lightweight construction, with stiff cylinder blocks and decoupled injectors, which ensure low levels of vibration and noise intrusion, further enhancing the driver experience. A series of advanced technologies reduce internal friction, improve refinement and enhance overall performance. In addition, Selective Catalytic Reduction and a new low-pressure exhaust gas recirculation system significantly reduce both CO₂ and NOx emissions on diesel engines.

INTELLIGENT SPEED LIMITER

The Intelligent Speed Limiter, when selected, will assist in limiting vehicle speed to the speed limits as recognised by the Traffic Sign Recognition system.

INTERIOR MOOD LIGHTING

Interior mood lighting highlights many of the cabin's key features and design details in a relaxing soft Phosphor Blue glow.

INTELLIGENT STOP/START

Stop/Start is a technology that stops the engine when it is not needed, improving the fuel economy and reducing the car's CO₂ emissions. The engine will restart as soon as the driver's foot comes off the brake pedal. The engine will be operating at full capacity before the driver's foot has touched the accelerator pedal.

J

JAGUAR SIGNATURE 'J' BLADE DAYTIME RUNNING LIGHTS

'J' blade Daytime Running Lights are separate LED running lights, in a distinctive 'J' shape, built into the headlights. They emphasise Jaguar's striking on road style.

JAGUARDRIVE CONTROL

Interacts with the Dynamic Stability Control system, engine and transmission management systems to alter the characteristics of the engine mapping, gearshifts and brakes. It offers different modes designed to optimise the vehicle's response to particular driving conditions and styles.

JAGUARDRIVE SELECTOR

The JaguarDrive Selector rises from the centre console on start up. It is a rotary shifter used with automatic transmissions that allows you to quickly shift between drive modes.

L

LED HEADLIGHTS WITH LED 'J' BLADE DAYTIME RUNNING LIGHTS

Multiple powerful LED emitters give a clearer light in low light conditions. Further complemented with LED 'J' blade Daytime Running Lights incorporating LED Direction Indicators. These lights also integrate Jaguar's Adaptive Lighting and Auto High Beam Assist systems.

M

MHL CONNECTION

A Mobile High-Definition Link (MHL) enables connection between a personal device and the InControl infotainment system. It is designed for seamless transfer of audio-visual data.

25.91 cm (10.2) MULTI-TOUCH DISPLAY

The Multi-touch functionality of InControl Touch Pro's 25.91 cm (10.2) Display allows the screen to recognise multiple points of contact. This provides direct control of the system's features in a more natural, intuitive way, enabling gestures such as pinch and zoom.



R

RAIN ICE SNOW MODE

By selecting Rain Ice Snow Mode, the system automatically dampens acceleration and applies more gradual torque for improved traction in slippery conditions.

S

SATELLITE VIEW

Satellite View allows you to view satellite imagery as an optional view mode for the navigation system.

SD CARD

A Secure Digital (SD) Card is a flash memory card used for storing large amounts of data in a compact form.

SOLID STATE DRIVE

Solid State Drives are storage devices with no moving parts designed for rapid retrieval of large quantities of data.

V

31.24 cm (12.3) VIRTUAL INSTRUMENT DISPLAY

The 31.24 cm (12.3) Virtual Instrument Display is a TFT (Thin Film Transistor) screen that replaces the traditional instrument cluster. It displays a wide range of key driving information. Four graphical themes and a 3D map view are available.

X

XENON HEADLIGHTS

Bi-function Xenon headlights offer improved illumination and feature LED 'J' blade Daytime Running Lights for a striking on road style.

Meridian is the registered trademark of Meridian Audio Limited.

AdBlue® is the registered trademark of the Verband der Automobilindustrie e. V. (VDA).

The Bluetooth® word mark and logos are owned by the Bluetooth SIG, Inc. and any use of such marks by Jaguar Land Rover Limited is under licence.

iPod, iPod touch and iPad are trademarks of Apple Inc, registered in the US and other countries.

**VEHICLE SHOWN FRONT AND BACK COVERS: XF S IN GLACIER WHITE
WITH OPTIONAL FEATURES FITTED (MARKET DEPENDENT)**

Jaguar Land Rover India Limited 3rd Floor,
Nanavati Mahalaya, 18 Homi Mody Street,
Mumbai - 400 001 India

IMPORTANT NOTICE

This publication is intended for use in India and whilst Jaguar takes the utmost care in ensuring that all details in the publication are correct at the time of going to press, we are constantly striving for improvement and therefore reserve the right to alter specifications and equipment without notice.

Details of specifications and equipment are also subject to change to suit local market conditions and requirements, and not all products are available in every market. Some vehicles are shown with accessories or optional equipment fitted. The colours reproduced here are subject to the limitations of the printing process and may therefore vary slightly from the actual vehicle. The company reserves the right to alter or withdraw any colour finish without notice. Please check availability of colours and current specifications with your Jaguar Retailer. Comparisons are based on manufacturer's own data and testing.

COLOURS

Print and online colours are representative only.

ENVIRONMENTAL INNOVATION AT JAGUAR

Jaguar is proud to continue the company's tradition with its approach to Environmental Innovation. From the choice of lightweight materials and lean production methods to the efficiency of its engines and designs, Jaguar is committed to operating as a more sustainable business and reducing its overall environmental impact.

Jaguar's flagship XF model was the first in the company to achieve ISO14040, the international standard for vehicle 'life cycle assessment'. This certification measures the environmental impact of XF from component material sourcing and manufacturing process, through driving 200 000 km. But that's not all. Every new Jaguar is designed to be 85 % recyclable and reusable, in addition to 95 % recoverable and reusable, with 10 % specifically for energy recovery.

The XJ, XF, XE, F-TYPE and F-PACE's innovative use of lightweight aluminium, which incorporates up to 50 % recycled material from the manufacturing process of the body structures, provided considerable performance benefits. This includes improved fuel consumption and less CO₂ emissions associated with lighter structures as well as the dynamic performance inherent in its weight saving design.

Jaguar is committed to reducing dependency on fossil fuels, using fewer resources and creating less waste as part of our approach to sustainability excellence.

The company plan includes 25 % reduction targets in operating and tailpipe CO₂ emissions, waste to landfill, logistics efficiencies (15 %) and water consumption (10 %), all based on per vehicle built since 2007. In addition the manufacturing assembly CO₂ emissions of each Jaguar built in the UK since 2009 is 100 % offset. For each tonne of CO₂ emitted in the assembly process, Jaguar invests in projects that reduce an equivalent tonne of CO₂ elsewhere.

Taking into account the company's global sales growth and increased investment in more efficient operating facilities, we are proud to have delivered and in some cases exceeded our Environmental Innovation targets as planned for 2012.

And we are on track to meet our 25 % reduction in joint European fleet average tailpipe CO₂ emissions by 2015. Looking forward, we have developed our 2020 vision for sustainable business growth that focuses on continued improvements in tailpipe CO₂ emissions, operational carbon neutrality and zero waste.

To date the company has offset over 6 million tonnes of CO₂, provided over 4 000 direct jobs in 60 emissions reductions projects in 17 countries and improved the lives of over 1 million people in our global cook stoves emissions reduction programme.

But it doesn't stop there. Our manufacturing facilities have been certified to ISO14001 since 1998 and we are credited to Platinum Plus level in the UK's Business in the Community Corporate Responsibility Index.



