

# FORD FIGO / FIGO ASPIRE Owner's Manual



Go Further

The information contained in this publication was correct at the time of going to print. In the interest of continuous development, we reserve the right to change specifications, design or equipment at any time without notice or obligation. No part of this publication may be reproduced, transmitted, stored in a retrieval system or translated into any language in any form by any means without our written permission. Errors and omissions excepted.

© Ford Motor Company 2015

All rights reserved.

Part Number: E4B5 19A321 ZCB 06/2015 20150612111803

# Table of Contents

---

## Introduction

About This Manual.....	5
Symbols Glossary.....	5
Data Recording.....	7
Replacement Parts Recommendation.....	8
Special Notices.....	8
Mobile Communications Equipment.....	8

## At a Glance

Front Exterior Overview - 4-Door.....	10
Front Exterior Overview - 5-Door.....	11
Rear Exterior Overview - 4-Door.....	12
Rear Exterior Overview - 5-Door.....	13
Vehicle Interior Overview - 4-Door.....	14
Vehicle Interior Overview - 5-Door.....	15
Instrument Panel Overview.....	16

## Child Safety

Installing Child Restraints.....	18
Child Restraint Positioning.....	19
Child Safety Locks.....	21

## Seatbelts

Fastening the Seatbelts.....	22
Seatbelt Height Adjustment.....	23
Seatbelt Warning Lamp and Indicator Chime.....	23
Seatbelt Reminder.....	24

## Supplementary Restraints System

Principle of Operation.....	25
Driver and Passenger Airbags.....	26
Side Airbags.....	27
Side Curtain Airbags.....	27
Crash Sensors and Airbag Indicator.....	27
Airbag Disposal.....	28

## Keys and Remote Controls

General Information on Radio Frequencies.....	29
Remote Control.....	29
Replacing a Lost Key or Remote Control.....	30

## MyKey™

Principle of Operation.....	31
Creating a MyKey.....	31
Programming a MyKey.....	32
Clearing All MyKeys.....	32
Checking MyKey System Status.....	32
Using MyKey With Remote Start Systems.....	32
MyKey Troubleshooting.....	33

## Locks

Locking and Unlocking.....	34
Manual Liftgate.....	36

## Security

Passive Anti-Theft System.....	37
Anti-Theft Alarm.....	37

## Steering Wheel

Adjusting the Steering Wheel.....	38
Audio Control.....	38
Voice Control.....	40

## Wipers and Washers

Windshield Wipers.....	41
Windshield Washers.....	41
Rear Window Wiper and Washers - 5-Door.....	42

## Lighting

Lighting Control.....	43
Headlamp Exit Delay.....	43
Front Fog Lamps.....	44

# Table of Contents

---

Rear Fog Lamps.....	44
Headlamp Leveling.....	45
Direction Indicators.....	46
Interior Lamps.....	46

## Windows and Mirrors

Power Windows - Vehicles With: One-Touch Up and Down Driver Window.....	47
Exterior Mirrors.....	48
Interior Mirror.....	50

## Instrument Cluster

Gauges.....	51
Warning Lamps and Indicators.....	52
Audible Warnings and Indicators.....	55

## Information Displays

General Information.....	56
Trip Computer.....	59
Personalized Settings.....	59
Information Messages.....	60

## Climate Control

Principle of Operation.....	65
Air Vents.....	65
Manual Climate Control.....	66
Automatic Climate Control.....	67
Hints on Controlling the Interior Climate.....	68
Heated Windows.....	71
Cabin Air Filter.....	71

## Seats

Sitting in the Correct Position.....	72
Head Restraints.....	72
Manual Seats.....	73
Rear Seats.....	74

## Auxiliary Power Points

Auxiliary Power Points.....	76
-----------------------------	----

## Storage Compartments

Cup Holders.....	77
Center Console.....	77
Bottle Holder.....	78
Map Pockets.....	78

## Starting and Stopping the Engine

General Information.....	79
Ignition Switch.....	79
Steering Wheel Lock.....	79
Starting a Gasoline Engine.....	80
Starting a Diesel Engine.....	81
Switching Off the Engine.....	81

## Fuel and Refueling

Safety Precautions.....	82
Fuel Quality - Gasoline.....	82
Fuel Quality - Diesel.....	83
Running Out of Fuel.....	83
Catalytic Converter.....	84
Refueling.....	84
Fuel Consumption.....	85

## Transmission

Manual Transmission.....	87
Automatic Transmission.....	88

## Brakes

General Information.....	92
Hints on Driving With Anti-Lock Brakes.....	92
Parking Brake.....	92
Hill Start Assist.....	93

# Table of Contents

---

<b>Traction Control</b>	
Principle of Operation.....	94
Using Traction Control.....	94
<b>Stability Control</b>	
Principle of Operation.....	95
Using Stability Control.....	95
<b>Driving Aids</b>	
Steering.....	96
<b>Load Carrying</b>	
General Information.....	97
Luggage Covers - 5-Door.....	97
<b>Towing</b>	
Towing Points.....	98
Towing the Vehicle on Four Wheels.....	99
<b>Driving Hints</b>	
Breaking-In.....	100
Economical Driving.....	100
Cold Weather Precautions.....	101
Driving Through Water.....	101
Floor Mats.....	101
<b>Roadside Emergencies</b>	
Hazard Warning Flashers.....	103
First Aid Kit.....	103
Warning Triangle.....	103
Fuel Shutoff.....	103
Jump Starting the Vehicle.....	104
Post-Crash Alert System.....	106
Transporting the Vehicle.....	106
<b>Fuses</b>	
Fuse Box Locations.....	108
Fuse Specification Chart - Gasoline.....	108
Fuse Specification Chart - Diesel.....	115
Changing a Fuse.....	122
<b>Maintenance</b>	
General Information.....	123
Opening and Closing the Hood.....	123
Under Hood Overview - 1.2L TiVCT/1.5L TiVCT.....	125
Under Hood Overview - 1.5L TDCi.....	126
Engine Oil Dipstick - 1.2L TiVCT/1.5L TiVCT.....	127
Engine Oil Dipstick - 1.5L TDCi.....	127
Engine Oil Check.....	127
Engine Coolant Check.....	128
Brake Fluid Check.....	129
Draining the Fuel Filter Water Trap.....	130
Washer Fluid Check.....	130
Changing the 12V Battery.....	131
Checking the Wiper Blades.....	131
Changing the Wiper Blades.....	132
Removing a Headlamp.....	133
Changing a Bulb - 4-Door.....	134
Changing a Bulb - 5-Door.....	136
Bulb Specification Chart.....	139
Changing the Engine Air Filter.....	140
<b>Vehicle Care</b>	
Cleaning the Exterior.....	141
Cleaning the Engine.....	141
Cleaning the Interior.....	142
Cleaning the Alloy Wheels.....	142
Vehicle Storage.....	143
<b>Wheels and Tires</b>	
General Information.....	145
Tire Care.....	145
Changing a Road Wheel.....	146
Tire Pressures.....	152

# Table of Contents

---

## Capacities and Specifications

Engine Specifications - 1.2L TiVCT.....	153
Engine Specifications - 1.5L TiVCT.....	154
Engine Specifications - 1.5L TDCi.....	155
Weights.....	156
Vehicle Dimensions - 4-Door.....	157
Vehicle Dimensions - 5-Door.....	159
Vehicle Identification Plate.....	161
Vehicle Identification Number.....	161
Capacities and Specifications - 1.2L TiVCT/1.5L TiVCT.....	162
Capacities and Specifications - 1.5L TDCi.....	163

## Audio System

General Information.....	166
Audio Unit - Vehicles With: AM/FM/CD/ SYNC.....	167
Audio Unit - Vehicles With: AM/FM/Aux In/USB/Bluetooth.....	171
Compact Disc Player.....	178
Audio Input Jack.....	182
Audio Troubleshooting.....	183
USB Port.....	184
Media Hub.....	184

## SYNC™

General Information.....	185
Using Voice Recognition.....	190
Using SYNC™ With Your Phone.....	192
SYNC™ Applications and Services.....	200
Using SYNC™ With Your Media Player.....	205
SYNC™ Troubleshooting.....	208

## Appendices

Electromagnetic Compatibility.....	219
End User License Agreement.....	220

# Introduction

## ABOUT THIS MANUAL

Thank you for choosing Ford. We recommend that you take some time to get to know your vehicle by reading this manual. The more that you know about your vehicle, the greater the safety and pleasure you will get from driving it.

### WARNING



Driving while distracted can result in loss of vehicle control, crash and injury. We strongly recommend that you use extreme caution when using any device that may take your focus off the road. Your primary responsibility is the safe operation of your vehicle. We recommend against the use of any hand-held device while driving and encourage the use of voice-operated systems when possible. Make sure you are aware of all applicable local laws that may affect the use of electronic devices while driving.

**Note:** This manual describes product features and options available throughout the range of available models, sometimes even before they are generally available. It may describe options not fitted to the vehicle you have purchased.

**Note:** Some of the illustrations in this manual may show features as used in different models, so they may appear different to you on your vehicle.

**Note:** Always use and operate your vehicle in line with all applicable laws and regulations.

**Note:** Pass on this manual when selling your vehicle. It is an integral part of your vehicle.

This manual may qualify the location of a component as left-hand side or right-hand side. The side is determined when facing forward in the seat.



E154903

- A Right-hand side.
- B Left-hand side.

## SYMBOLS GLOSSARY

These are some of the symbols you may see on your vehicle.



Safety alert



See Owner's Manual



Air conditioning system



Anti-lock braking system



Avoid smoking, flames or sparks



Battery



Battery acid



Brake fluid - non petroleum based

# Introduction



Brake system



Cabin air filter



Check fuel cap



Child safety door lock or unlock



Child seat lower anchor



Child seat tether anchor



Cruise control



Do not open when hot



Electronic power steering malfunction



Engine air filter



Engine coolant



Engine coolant temperature



Engine oil



Explosive gas



Fan warning



Fasten seatbelt



Front airbag



Front fog lamps



Fuel pump reset



Fuse compartment



Hazard warning flashers



Heated rear window



Heated windshield



Interior luggage compartment release



Jack



Keep out of reach of children



Lighting control



Low tire pressure warning



Maintain correct fluid level



Note operating instructions



# Introduction



Panic alarm



Parking aid



Parking brake



Power steering fluid



Power windows front/rear



Power window lockout



Service engine soon



Side airbag



Shield the eyes



Stability control



Windshield wash and wipe

## DATA RECORDING

A large number of electronic components of your vehicle contain data storage modules temporarily or permanently storing technical data about the condition of the vehicle, events and malfunctions.

In general, this technical information documents the condition of parts, modules, systems or the environment:

- Operating conditions of system components (e.g. filling levels).
- Status messages of the vehicle and its individual components (e.g. number of wheel revolutions/rotational speed, deceleration, lateral acceleration).
- Malfunctions and defects in important system components (e.g. lighting and brake system).
- Vehicle reactions in particular driving situations (e.g. inflation of an airbag, activation of the stability regulation system).
- Environmental conditions (e.g. temperature).

These data are exclusively technical and help identification and correction of malfunctions as well as optimisation of vehicle functions. Motion profiles indicating travelled routes cannot be created with these data.

If services are used (e.g. repair works, service processes, warranty cases, quality assurance), employees of the service network (including manufacturers) are able to read out this technical information from the event and malfunction data storage modules using special diagnostic devices. If required, you will receive further information. After a malfunction has been corrected, these data are deleted from the malfunction storage module or they are constantly overwritten.

When using the vehicle, situations may occur in which these technical data related to other information (accident report, damages on the vehicle, witness statements, etc.) may be associated with a specific person - possibly, with the assistance of an expert.

# Introduction

---

Additional functions contractually agreed upon with the client (e.g. vehicle location in emergency cases) allow the transmission of particular vehicle data from the vehicle.

## REPLACEMENT PARTS RECOMMENDATION

Your vehicle has been built to the highest standards using quality parts. We recommend that you demand the use of genuine Ford and Motorcraft parts whenever your vehicle requires scheduled maintenance or repair. You can clearly identify genuine Ford and Motorcraft parts by looking for the Ford, FoMoCo or Motorcraft branding on the parts or their packaging.

### Scheduled Maintenance and Mechanical Repairs

One of the best ways for you to make sure that your vehicle provides years of service is to have it maintained in line with our recommendations using parts that conform to the specifications detailed in this Owner's Manual. Genuine Ford and Motorcraft parts meet or exceed these specifications.

### Collision Repairs

We hope that you never experience a collision, but accidents do happen. Genuine Ford replacement collision parts meet our stringent requirements for fit, finish, structural integrity, corrosion protection and dent resistance. During vehicle development we validate these parts deliver the intended level of protection as a whole system. A great way to know for sure you are getting this level of protection is to use genuine Ford replacement collision parts.

## Warranty on Replacement Parts

Genuine Ford and Motorcraft replacement parts are the only replacement parts that benefit from a Ford Warranty. Damage caused to your vehicle as a result of the failure of non-Ford parts may not be covered by the Ford Warranty. For additional information, refer to the terms and conditions of the Ford Warranty.

## SPECIAL NOTICES

### WARNING



Do not use abrasives or chemicals solvents on the tag.

We have installed the radio frequency identifier (RFID) tag in your vehicle in compliance with the government directives under the MORTH final notification GSR 207 (E), dated 08 April 2013. Ford does not in any way guarantee or warrant the quality, contents, accuracy of the product or data contained in the tag.

This tag is for the exclusive use of government authorities or personnel authorized by the government. The responsibility of keeping and maintaining the RFID tag is with the owner of the vehicle.

**Note:** *The tag is on the top left-hand side of the windshield.*

## MOBILE COMMUNICATIONS EQUIPMENT

Using mobile communications equipment is becoming increasingly important in the conduct of business and personal affairs. However, you must not compromise your own or others' safety when using such equipment. Mobile communications can enhance personal safety and security when

# Introduction

---

appropriately used, particularly in emergency situations. Safety must be paramount when using mobile communications equipment to avoid negating these benefits. Mobile communication equipment includes, but is not limited to, cellular phones, pagers, portable email devices, text messaging devices and portable two-way radios.

## **WARNING**



Driving while distracted can result in loss of vehicle control, crash and injury. We strongly recommend that you use extreme caution when using any device that may take your focus off the road. Your primary responsibility is the safe operation of your vehicle. We recommend against the use of any hand-held device while driving and encourage the use of voice-operated systems when possible. Make sure you are aware of all applicable local laws that may affect the use of electronic devices while driving.

---

# At a Glance

## FRONT EXTERIOR OVERVIEW - 4-DOOR

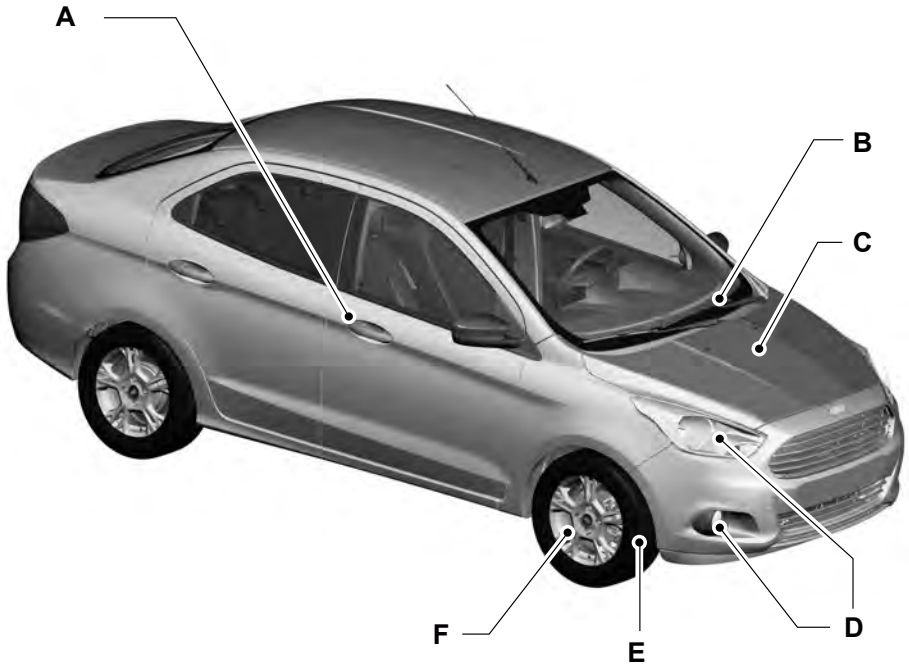

E175545

- A See **Locking and Unlocking** (page 34).
- B See **Windshield Wipers** (page 41).
- C See **Maintenance** (page 123).
- D See **Changing a Bulb** (page 134).
- E Tire pressures. See **Tire Pressures** (page 152).
- F See **Changing a Road Wheel** (page 146).

# At a Glance

## FRONT EXTERIOR OVERVIEW - 5-DOOR

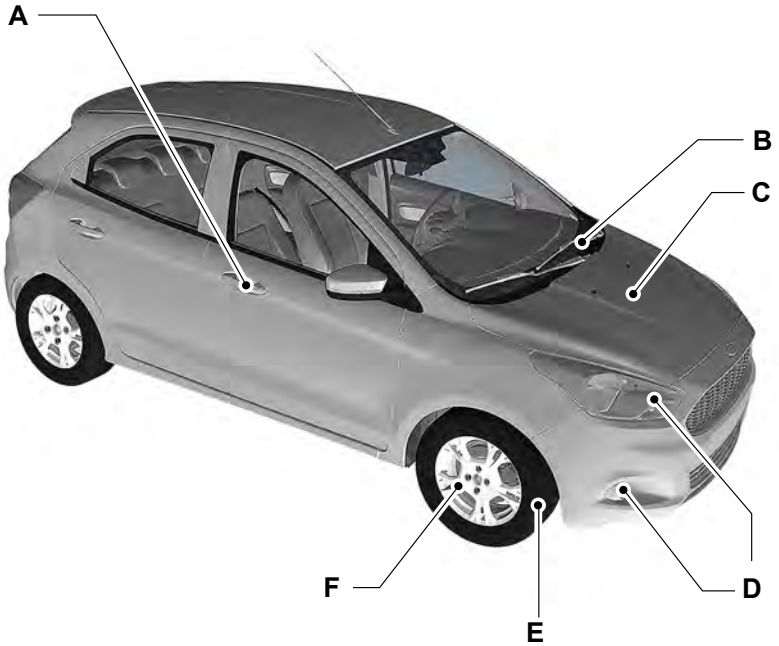

E174263

- A See **Locking and Unlocking** (page 34).
- B See **Windshield Wipers** (page 41).
- C See **Maintenance** (page 123).
- D See **Changing a Bulb** (page 136).
- E Tire pressures. See **Tire Pressures** (page 152).
- F See **Changing a Road Wheel** (page 146).

# At a Glance

## REAR EXTERIOR OVERVIEW - 4-DOOR

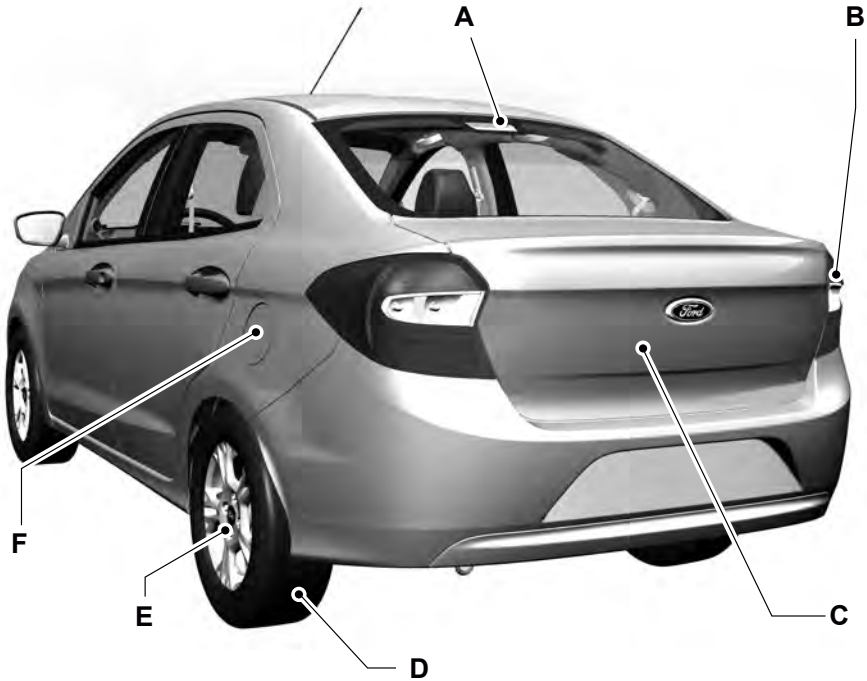

E175546

- A See **Changing a Bulb** (page 134).
- B See **Changing a Bulb** (page 134).
- C See **Manual Liftgate** (page 36).
- D Tire pressures. See **Tire Pressures** (page 152).
- E See **Changing a Road Wheel** (page 146).
- F See **Refueling** (page 84).

# At a Glance

## REAR EXTERIOR OVERVIEW - 5-DOOR

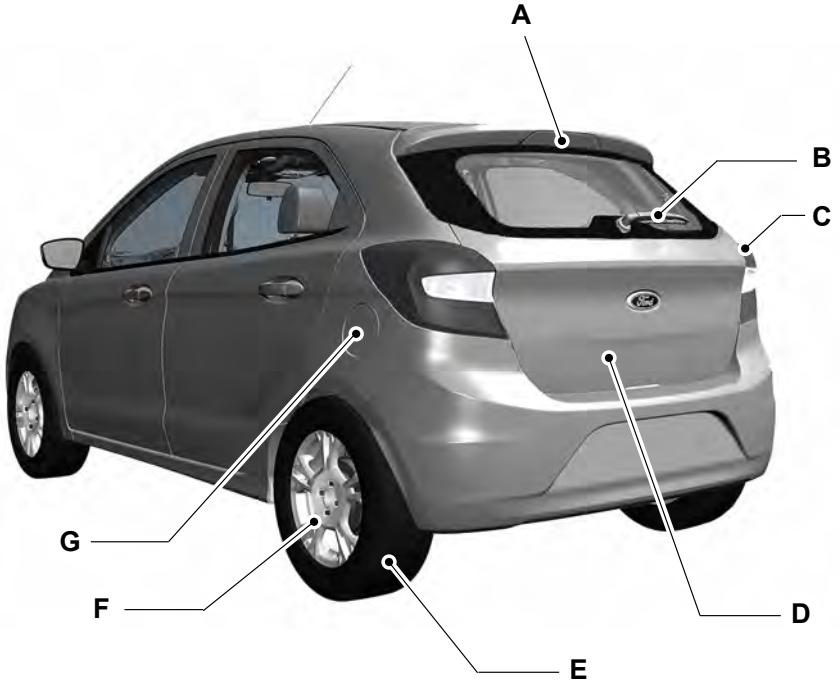

- A See **Changing a Bulb** (page 136).
- B See **Windshield Wipers** (page 41).
- C See **Changing a Bulb** (page 136).
- D See **Manual Liftgate** (page 36).
- E Tire pressures. See **Tire Pressures** (page 152).
- F See **Changing a Road Wheel** (page 146).
- G See **Refueling** (page 84).

# At a Glance

## VEHICLE INTERIOR OVERVIEW - 4-DOOR

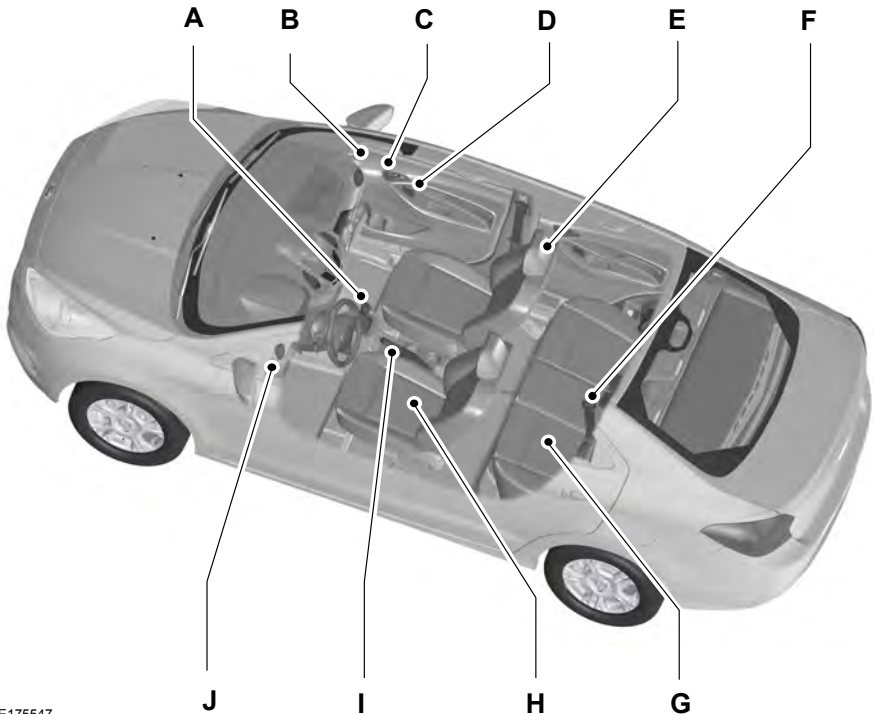

E175547

- A See **Transmission** (page 87).
- B See **Exterior Mirrors** (page 48).
- C See **Locking and Unlocking** (page 34).
- D See **Power Windows** (page 47).
- E See **Head Restraints** (page 72).
- F See **Fastening the Seatbelts** (page 22).
- G See **Rear Seats** (page 74).
- H See **Manual Seats** (page 73).



# At a Glance

- I See **Parking Brake** (page 92).
- J See **Opening and Closing the Hood** (page 123).

## VEHICLE INTERIOR OVERVIEW - 5-DOOR

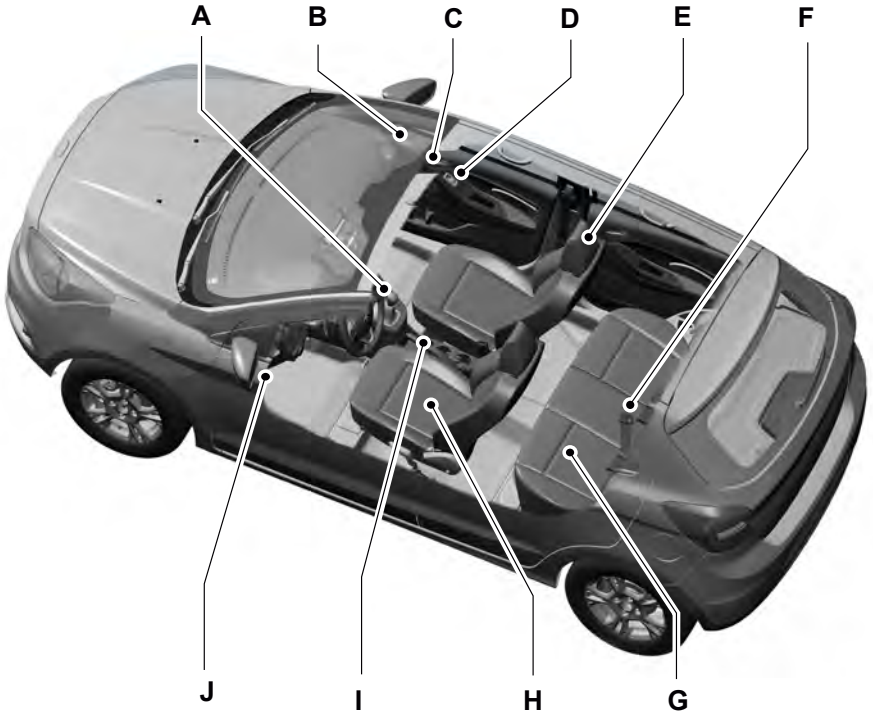

E174732

- A See **Transmission** (page 87).
- B See **Exterior Mirrors** (page 48).
- C See **Locking and Unlocking** (page 34).
- D See **Power Windows** (page 47).

## At a Glance

- E See **Head Restraints** (page 72).
- F See **Fastening the Seatbelts** (page 22).
- G See **Rear Seats** (page 74).
- H See **Manual Seats** (page 73).
- I See **Parking Brake** (page 92).
- J See **Opening and Closing the Hood** (page 123).

## INSTRUMENT PANEL OVERVIEW

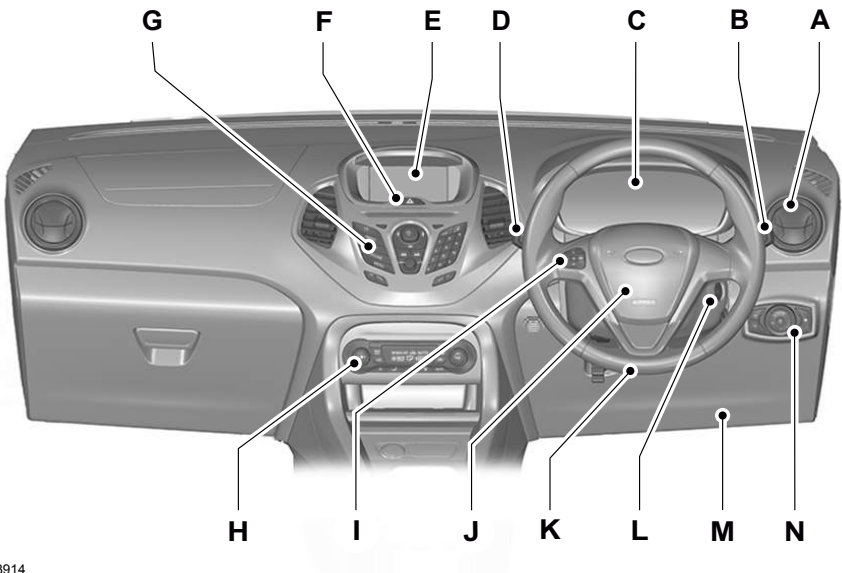

E203914

- A Air vents. See **Air Vents** (page 65).
- B Direction indicators. See **Direction Indicators** (page 46). High beam. See **Lighting Control** (page 43).
- C Instrument cluster. See **Gauges** (page 51). See **Warning Lamps and Indicators** (page 52).

## At a Glance

---

- D Wiper lever. See **Wipers and Washers** (page 41).
- E Information and entertainment display. See **Information Displays** (page 56).
- F Hazard warning flasher switch. See **Hazard Warning Flashers** (page 103).
- G Audio unit. See **Audio System** (page 166).
- H Climate controls. See **Climate Control** (page 65).
- I Audio control. See **Steering Wheel** (page 38).
- J Horn.
- K See **Steering Wheel** (page 38).
- L Ignition switch. See **Ignition Switch** (page 79).
- M Hood release lever. See **Opening and Closing the Hood** (page 123).
- N Lighting control. See **Lighting Control** (page 43).

# Child Safety

## INSTALLING CHILD RESTRAINTS







E133140





E68916

### WARNINGS

-  Use an approved child restraint to secure children less than 150 cm tall in the rear seat.
-  Extreme Hazard! Do not use a rearward facing child restraint on a seat protected by an air bag in front of it!
-  Read and follow the manufacturer's instructions when you are fitting a child restraint.
-  Do not modify child restraints in any way.

### WARNINGS

-  Do not hold a child on your lap when the vehicle is moving.
-  Do not leave unattended children in your vehicle.
-  If your vehicle has been involved in an accident, have the child restraints checked by an authorized dealer.

**Note:** Children should be properly restrained in a rear seating position whenever possible. When using a child safety seat ensure that the rear seat back is in the most upright position.

## Child Restraints for Different Mass Groups

Use the correct child restraint as follows:

### Baby Safety Seat



E68918

Secure children that weigh less than 13 kg in a rearward facing baby safety seat (Group 0+) in the rear seat.

# Child Safety

## Child Safety Seat



E68920

Secure children that weigh between 13–18 kg in a child safety seat (Group 1) in the rear seat.

## Booster Seats

### WARNINGS



Do not install a booster seat or a booster cushion with only the lap strap of the safety belt.



Do not install a booster seat or a booster cushion with a safety belt that is slack or twisted.



Do not put the safety belt under your child's arm or behind its back.



Do not use pillows, books or towels to boost your child's height.



Make sure that your children sit in an upright position.



Secure children that weigh more than 15 kg but are less than 150 cm tall in a booster seat or a booster cushion.

**Note:** *When using a child seat on a rear seat, make sure that the child seat rests tightly against the vehicle seat. It may be necessary to lift or remove the head restraint. See **Head Restraints** (page 72).*

## Booster Seat (Group 2)



E70710

We recommend that you use a booster seat that combines a cushion with a backrest instead of a booster cushion only. The raised seating position will allow you to position the shoulder strap of the adult safety belt over the center of your child's shoulder and the lap strap tightly across its hips.

## Booster Cushion (Group 3)



E68924

## CHILD RESTRAINT POSITIONING

### WARNINGS



Please consult your authorized dealer for the latest details relating to Ford recommended child seats.

# Child Safety

## WARNINGS



Extreme Hazard! Do not use a rearward facing child restraint on a seat protected by an air bag in front of it!



When using a child seat with a support leg, the support leg must rest securely on the floor.



When using a child seat with a safety belt, make sure that the safety belt is not slack or twisted.

## WARNINGS



The child seat must rest tightly against the vehicle seat. It may be necessary to lift or remove the head restraint. See **Head Restraints** (page 72).

**Note:** *When using a child seat on a front seat, always adjust the front passenger seat as far back as possible. If it proves difficult to tighten the lap section of the seatbelt without slack remaining, adjust the seat backrest.*

Seating positions	Mass group categories				
	0	0+	1	2	3
	Up to 10 kg (22 lbs)	Up to 13 kg (29 lbs)	9 - 18 kg (20 - 40 lbs)	15 - 25 kg (33 - 55 lbs)	22 - 36 kg (46 - 79 lbs)
Front Passenger	X	X	UF <sup>1</sup>	UF <sup>1</sup>	UF <sup>1</sup>
Rear Outboard	U	U	U	U	U
Rear center	X	X	X	X	X

**X** Not suitable for children in this mass group.

**U** Suitable for universal category child restraints approved for use in this mass group.

**UF<sup>1</sup>** Suitable for universal category forward facing child restraints approved for use in this mass group.

# Child Safety

---

## CHILD SAFETY LOCKS

### WARNING



You cannot open the rear doors from inside if you have put the child safety locks on.

---



E176962

The childproof locks are located on the rear edge of each rear door and must be set separately for each door.

### Left-Hand Side

Turn counterclockwise to lock and clockwise to unlock.

### Right-Hand Side

Turn clockwise to lock and counterclockwise to unlock.

# Seatbelts

## FASTENING THE SEATBELTS

### WARNINGS



Insert the tongue into the buckle until you hear a distinct click. You have not fastened the safety belt properly if you do not hear a click.



Make sure that your safety belt is securely stored and is not outside the vehicle when closing the door.

**Note:** *Fasten the safety belt only with the vehicle at a standstill, and never when the vehicle is moving. It may lock if you pull it sharply or if the vehicle is on a slope.*

Always use the safety belts and child restraint systems.

The upper belt strap should rest on the shoulder, never over the neck. The lower belt strap should be placed over the pelvic area, never over the stomach.

Never use one belt for more than one person. Make sure the belts are not twisted or loose, nor obstructed by other passengers or packages.

Do not recline the front seat backrests excessively, as the safety belts only provide maximum protection when the backrests are in a nearly vertical position.

### Retractable-inertial three-point safety belts

Three-point safety belts are available with the front seats and outboard position for the rear seats. Keep the safety belt buckle on the rear floor free from luggage or objects.

### Buckling the safety belt

Pull the belt with a steady movement to avoid a block. Insert the tongue tab into the buckle until you hear a click, and make sure it is locked in place. To tighten the rear center lap belt, pull the loose end through the tongue until the belt is comfortably adjusted around the hips.

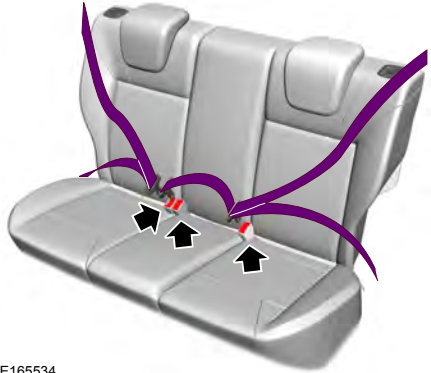

E165534

### Releasing the safety belt

Press the red button on the buckle, then let the belt roll up smoothly and completely.



E74124



# Seatbelts

## Using Safety Belts During Pregnancy

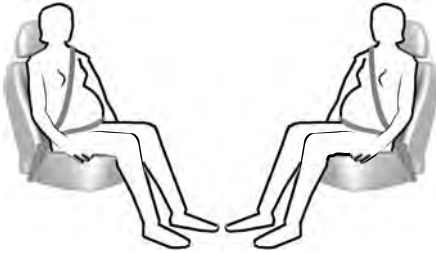

E68587

### WARNING



Position the safety belt correctly for your safety and that of your unborn child. Do not use only the lap strap or the shoulder strap.

Position the lap strap comfortably across your hips and low beneath your pregnant abdomen. Position the shoulder strap between your breasts, above and to the side of your pregnant abdomen.

## SEATBELT HEIGHT ADJUSTMENT

### WARNING



Position the safety belt height adjuster so that the belt rests across the middle of your shoulder. Failure to adjust the safety belt properly could reduce the effectiveness of the safety belt and increase the risk of injury in a crash.

Adjust the height of the shoulder belt so the belt rests across the middle of your shoulder.

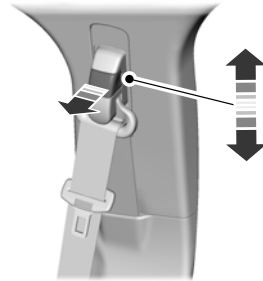

E145664

To adjust the shoulder belt height:

1. Pull the button and slide the height adjuster up or down.
2. Release the button and pull down on the height adjuster to make sure it is locked in place.

## SEATBELT WARNING LAMP AND INDICATOR CHIME (if

Equipped)



This lamp illuminates if the driver's safety belt has not been fastened when the vehicle's ignition is turned on.

# Seatbelts

## Conditions of operation

If...	Then...
The driver's safety belt is not buckled before the ignition switch is turned to the on position...	The safety belt warning light illuminates for 5 seconds.
The driver's safety belt is buckled while the indicator light is illuminated and the warning chime is sounding...	The safety belt warning light and warning chime turn off.
The driver's safety belt is buckled before the ignition switch is turned to the on position...	The safety belt warning light and indicator chime remain off.

## SEATBELT REMINDER (If Equipped)

### WARNING



The system will only provide protection when you use the safety belt properly.

The warning lamp illuminates and an audible warning will sound when both of the following conditions have been met:

- The driver's safety belt has not been fastened.
- The vehicle exceeds a relatively low speed.

If you do not fasten your safety belt, both warnings will switch off automatically after about five minutes.

## Deactivating the Safety Belt Minder

See your authorized dealer.

# Supplementary Restraints System

## PRINCIPLE OF OPERATION

### WARNINGS

 Airbags do not inflate slowly or gently, and the risk of injury from a deploying airbag is the greatest close to the trim covering the airbag module.

 All occupants of your vehicle, including the driver, should always properly wear their safety belts, even when an airbag supplemental restraint system is provided. Failure to properly wear your safety belt could seriously increase the risk of injury or death.

 Always transport children 12 years old and under in the back seat and always properly use appropriate child restraints. Failure to follow this could seriously increase the risk of injury or death.

 Never place your arm over the airbag module as a deploying airbag can result in serious arm fractures or other injuries.

 Airbags can kill or injure a child in a child seat. Never place a rear-facing child seat in front of an active airbag. If you must use a forward-facing child seat in the front seat, move the seat upon which the child seat is installed all the way back.

 Do not attempt to service, repair, or modify the airbag supplemental restraint systems or its fuses as you could be seriously injured or killed. Contact your authorized dealer as soon as possible.

 Several airbag system components get hot after inflation. Do not touch them after inflation as this may result in serious injury.

 If the airbag has deployed, the airbag will not function again and must be replaced immediately. If the airbag is not replaced, the unrepaired area will increase the risk of injury in a collision.

The airbags are a supplemental restraint system and are designed to work with the safety belts to help protect the driver and front passenger from certain upper body injuries. Airbags do not inflate slowly; there is a risk of injury from a deploying airbag.

**Note:** *You will hear a loud bang and see a cloud of harmless powdery residue if an airbag deploys. This is normal.*

The airbags inflate and deflate rapidly upon activation. After airbag deployment, it is normal to notice a smoke-like, powdery residue or smell the burnt propellant which may irritate the skin and eyes, but none of the residue is toxic.

While the system is designed to help reduce serious injuries, contact with a deploying airbag may also cause abrasions or swelling. Temporary hearing loss is also a possibility as a result of the noise associated with a deploying airbag. Because airbags must inflate rapidly and with considerable force, there is the risk of death or serious injuries such as fractures, facial and eye injuries or internal injuries, particularly to occupants who are not properly restrained or are otherwise out of position at the time of airbag deployment. Thus, it is extremely important that occupants be properly restrained as far away from the airbag module as possible while maintaining vehicle control.

Routine maintenance of the airbags is not required.

# Supplementary Restraints System

## DRIVER AND PASSENGER AIRBAGS (If Equipped)

### WARNING



Never place your arm or any objects over an airbag module. Placing your arm over a deploying airbag can result in serious arm fractures or other injuries. Objects placed on or over the airbag inflation area may cause those objects to be propelled by the airbag into your face and torso causing serious injury.

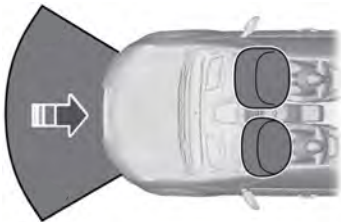

E151127

The driver and front passenger airbags will deploy during significant frontal and near frontal crashes.

### Proper Driver and Front Passenger Seating Adjustment

To properly position yourself away from the airbag:

- Move your seat to the rear as far as you can while still reaching the pedals comfortably.
- Recline the seat slightly (one or two degrees) from the upright position.

After all occupants have adjusted their seats and put on safety belts, it is very important that they continue to sit properly. A properly seated occupant sits upright, leaning against the seat back, and centered on the seat cushion, with their feet comfortably extended on the floor. Sitting improperly can increase the chance of injury in a crash event. For example, if an occupant slouches, lies down, turns sideways, sits forward, leans forward or sideways, or puts one or both feet up, the chance of injury during a crash is greatly increased.

## Children and Airbags

### WARNING



Airbags can kill or injure a child in a child seat. Never place a rear-facing child seat in front of an active airbag. If you must use a forward-facing child seat in the front seat, move the seat upon which the child seat is installed all the way back.



E142846

Children must always be properly restrained. Accident statistics suggest that children are safer when properly restrained in the rear seating positions than in the front seating position. Failure to follow these instructions may increase the risk of injury in a crash.

# Supplementary Restraints System

## SIDE AIRBAGS (If Equipped)

### WARNING



Use seat covers designed for seats with side airbags. Have these fitted by an authorized dealer.



E72658

The airbags are located inside the seatback of the front seats. There is a label attached to the side of the seatback to indicate this.

The airbag will deploy during significant lateral collisions. It might also deploy during significant frontal collisions. The airbag will not deploy in minor lateral and frontal collisions, rear collisions, or overturns.

## SIDE CURTAIN AIRBAGS (If Equipped)

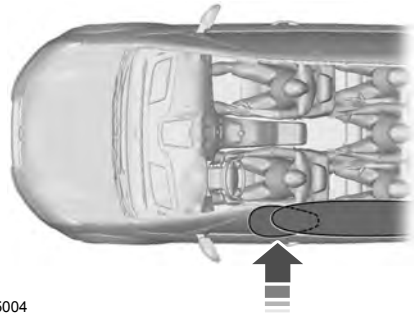

E75004

The airbags are located over the front and rear side windows.

The airbag will deploy during significant lateral collisions. It will also deploy during significant frontal angled collisions. The curtain airbag will not deploy in minor lateral and frontal collisions, rear collisions, or overturns.

## CRASH SENSORS AND AIRBAG INDICATOR (If Equipped)

### WARNING



Modifying or adding equipment to the front end of the vehicle (including but not limited to frame, bumper, front end body structure and tow hooks) may affect the performance of the airbag system, increasing the risk of injury. Do not modify the front end of the vehicle.

# Supplementary Restraints System

---

The restraints control module monitors the readiness of the safety devices plus the crash and occupant sensors. The readiness of the safety system is indicated by a warning indicator light in the instrument cluster or by a backup tone if the warning light is not working. Routine maintenance of the airbag is not required.

A malfunction in the system is indicated by one or more of the following:



The readiness light will not illuminate immediately after the ignition is turned on.

- The readiness light will either flash or stay lit.
- A series of five beeps will be heard. The tone pattern will repeat periodically until the problem, the light or both are repaired.

If any of these things happen, even intermittently, have the supplemental restraint system serviced at an authorized dealer immediately. Unless serviced, the system may not function properly in the event of a crash.

The driver's safety belt pretensioner and the front airbag supplemental restraint system are designed to activate when the vehicle sustains longitudinal deceleration sufficient to cause the restraints control module to deploy a safety device.

The fact that the driver's safety belt pretensioner or front airbags did not activate for both front seat occupants in a crash does not mean that something is wrong with the system. Rather, it means the restraints control module determined the accident conditions (crash severity, belt usage) were not appropriate to activate these safety devices.

- The front airbags activate only in frontal and near-frontal crashes (not rollovers, side impacts or rear impacts) unless the crash causes sufficient longitudinal deceleration.
- The design of the driver safety belt pretensioner is to activate in frontal and near-frontal crashes.

## AIRBAG DISPOSAL

Contact your authorized dealer as soon as possible. Airbags must be disposed of by qualified personnel.

# Keys and Remote Controls

## GENERAL INFORMATION ON RADIO FREQUENCIES

**Note:** Changes or modifications not expressly approved by the party responsible for compliance could void the user's authority to operate the equipment.

The typical operating range for your transmitter is approximately 10 m.

A decrease in operating range could be caused by:

- weather conditions
- nearby radio towers
- structures around your vehicle
- other vehicles parked next to your vehicle.

The radio frequency used by your remote control can also be used by other radio transmitters, for example amateur radios, medical equipment, wireless headphones, wireless remote controls, cell phones, battery chargers and alarm systems. If the frequencies are jammed, you will not be able to use your remote control. You can lock and unlock the doors with the key.

**Note:** Make sure your vehicle is locked before leaving it unattended.

**Note:** If you are in range, the remote control will operate if you press any button unintentionally.

**Note:** The remote control contains sensitive electrical components. Exposure to moisture or impact may cause permanent damage.

## REMOTE CONTROL

Your authorized dealer can program a maximum of eight remote controls to your vehicle.

## Changing the Remote Control Battery



Make sure that you dispose of old batteries in an environmentally friendly way. Seek advice from your local authority regarding recycling.

## Remote Control With a Folding Key Blade



E192327

1. Insert a screwdriver as far as possible into the slot on the side of the remote control, gently push the clip.
2. Press the clip down to release the battery cover.

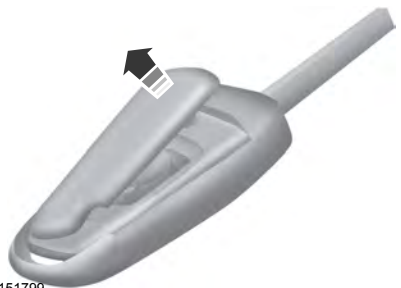

E151799

3. Carefully remove the cover.

## Keys and Remote Controls

---



E151800

4. Turn the remote control over to remove the battery.



E151801

**Note:** Do not touch the battery contacts or the printed circuit board with the screwdriver.

5. Install a new battery (3V CR 2032) with the + facing upwards.
6. Replace the battery cover.

### REPLACING A LOST KEY OR REMOTE CONTROL

Replacement keys or remote controls can be purchased from an authorized dealer. Authorized dealers can program remote controls for your vehicle. See **Passive Anti-Theft System** (page 37).



## PRINCIPLE OF OPERATION

The system allows you to program keys with restricted driving modes to promote good driving habits. All but one of the keys programmed to the vehicle can be activated with these restricted modes.

Any keys that have not been programmed are referred to as administrator keys or admin keys. These can be used to:

- Create a MyKey.
- Program configurable MyKey settings.
- Clear all MyKey features.

When you have created a MyKey, you can access the following information using the information display:

- How many admin keys and MyKeys are programmed to your vehicle.
- The total distance your vehicle has traveled using a MyKey.

**Note:** *All MyKeys are programmed to the same settings. You cannot program them individually.*

**Note:** *Switch the ignition on to use the system.*

## Non-configurable Settings

The following settings cannot be changed by an admin key user:

- Safety belt minder. You cannot disable this feature. The audio system will mute when this feature is activated.
- Early low fuel. The low-fuel warning activates earlier, giving the MyKey user more time to refuel.
- Driver assist features, for example parking aid, if equipped on your vehicle, are forced on. These systems turn on automatically whenever you switch the ignition on.

## Configurable Settings

With an admin key, you can configure certain MyKey settings when you first create a MyKey and before you recycle the key or restart the vehicle.

You can also change the settings afterward with an admin key:

- Vehicle speed limits can be set. Warnings will be shown in the display followed by an audible tone when your vehicle reaches the set speed. You cannot override the set speed by fully depressing the accelerator pedal.
- Various vehicle speed reminders can be set. Warnings will be shown in the display followed by an audible tone when the set vehicle speed is exceeded.
- Audio system maximum volume of 45%. A message will be shown in the display when you attempt to exceed the limited volume. Also, the speed sensitive compensated volume (automatic volume control) feature will be disabled.
- Always on setting. When this is selected, you will not be able to disable emergency assistance or the do not disturb feature (if your vehicle is equipped with these features).

## CREATING A MYKEY

1. Insert the key you want to program into the ignition.
2. Switch the ignition on.
3. Access the main menu using the information display. Select **MyKey** and press **OK** or the right arrow button.
4. Select **Create MyKey** and press **OK**.

5. When prompted, hold the **OK** button until you see a message informing you to label this key as a MyKey. The key will be restricted at the next start.

MyKey is successfully created. Make sure you label it so you can distinguish it from the admin keys.

You can program configurable settings for the key(s). Refer to **Programming a MyKey**.

## PROGRAMMING A MYKEY

### Optional Settings

1. Switch the ignition on using an admin key.
2. Access the main menu using the information display. Select **MyKey** and press **OK** or the right arrow button.
3. Use the arrow buttons to scroll to an optional feature.
4. Press **OK** or the right arrow button to scroll through the settings.
5. Press **OK** or the right arrow button to make a selection.

## CLEARING ALL MYKEYS

**Note:** *Clearing all MyKeys will return the admin key to its default setting and reset the MyKey distance to zero.*

1. Switch the ignition on using an admin key.
2. Access the main menu using the information display. Select **MyKey** and press **OK** or the right arrow button.
3. Scroll to **Clear All** and press **OK**.
4. Press and hold **OK** until you see a message informing you that all MyKeys have been cleared.

## CHECKING MYKEY SYSTEM STATUS

You can find information about your programmed MyKeys by using the information display.

### MyKey Distance

Tracks the distance when drivers use a MyKey. The only way to delete the accumulated distance is by using an admin key to clear all MyKeys. If the distance does not accumulate as expected, then the intended user is not using the MyKey, or an admin key user recently cleared and then recreated a MyKey.

### Number of MyKeys

Indicates the number of MyKeys programmed to your vehicle. Use this feature to detect how many MyKeys you have for your vehicle and determine when all MyKeys have been deleted.

### Number of Admin Keys

Indicates how many admin keys are programmed to your vehicle. Use this feature to determine how many admin keys you have for your vehicle, and detect if an additional MyKey has been programmed.

## USING MYKEY WITH REMOTE START SYSTEMS

MyKey is not compatible with non-Ford-approved aftermarket remote start systems. If you choose to install a remote start system, please see an authorized dealer for a Ford-approved remote start system.

## MYKEY TROUBLESHOOTING

### All Vehicles

Condition	Potential Causes
I cannot create a MyKey.	The key in the ignition is not an admin key. The key in the ignition is the only key. There always has to be at least one admin key.
I cannot program the optional settings.	The key in the ignition is not an admin key. There are no MyKeys programmed to your vehicle. See <b>Creating a MyKey</b> (page 31).
I cannot clear the MyKeys.	The key in the ignition is not an admin key. There are no MyKeys programmed to your vehicle. See <b>Creating a MyKey</b> (page 31).
I have lost the only admin key.	Purchase a new key from an authorized dealer.
The MyKey distance does not accumulate.	The MyKey is not being used by the intended user. The MyKeys have been cleared. See <b>Clearing All MyKeys</b> (page 32).

# Locks

## LOCKING AND UNLOCKING

You can use the manual door lock control, the key or the remote control to lock and unlock the vehicle.

### Manual Door Locks

The manual door lock control is on the inner handle of the driver's door.

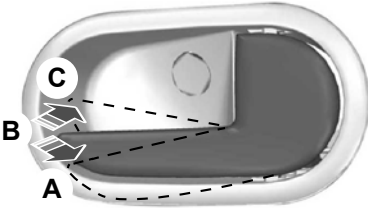

E208591

A	Pull to open.
B	Unlocks all doors.
C	Push to lock all doors.

### Rear Door Unlocking and Opening

Pull the interior door handle to unlock and open a rear door.

### Remote Control

You can use the remote control at any time. The luggage compartment release button will only work when the vehicle speed is less than 5 km/h

### Unlocking the Doors



Press the button to unlock all doors.

The turn signals will flash.

### Locking the Doors



Press the button to lock all the doors. The turn signals will flash if all the doors, the luggage compartment and the hood are closed.

Press the button again within three seconds to confirm that all the doors are closed. The doors will lock again, the horn will sound once and the turn signals will flash twice if all the doors, the luggage compartment and the hood are closed.

### Mislock

If you press the button with any one door opened, the vehicle will lock and then unlock immediately. If you press the button again within 3 seconds, the horn will sound twice to warn that not all doors are closed correctly.

### Opening the Luggage Compartment



Press the button twice within three seconds to open the luggage compartment.

Make sure to close and latch the luggage compartment before driving your vehicle. An unlatched luggage compartment may cause objects to fall out or block your view.

### Auto Relock

If you press the unlock button on the remote control and do not open a door within 45 seconds, your vehicle will lock and the alarm will arm.

### Autolock Feature (If Equipped)

The autolock feature will lock all the doors when:

- All doors are closed.
- The ignition is on.

# Locks

- You shift into any gear putting your vehicle in motion.
- Your vehicle attains a speed greater than 20 km/h.

The autolock feature repeats when:

- You open then close any door while the ignition is on and your vehicle speed is 15 km/h or lower.
- Your vehicle attains a speed greater than 20 km/h.

## Enabling or Disabling

**Note:** *Autolock feature can be enabled or disabled with the help of your authorized dealer.*

## Illuminated Entry

The interior lamps and select exterior lamps will illuminate when you unlock the doors with the remote entry system.

The illuminated entry system will turn off the lights if:

- The ignition is on.
- You press the remote control lock button.
- After 25 seconds of illumination.

The lights do not turn off if:

- You turn them on with the lamp control.
- Any door is open.

## Illuminated Exit

The interior lamps and select exterior lamps will illuminate when all doors are closed, you switch the ignition off and you remove the key from the ignition (integrated keyhead transmitter only).

The lamps will turn off if all the doors remain closed and:

- 25 seconds have elapsed.
- You press the remote control lock button.

## Battery Saver

If you leave the courtesy lamps, dome lamps, the battery saver will shut them off 10 minutes after you switch the ignition off.

## Luggage Compartment



E174655

Press the release button is located near the lighting control switch, or use the remote control to release the luggage compartment.

## MANUAL LIFTGATE

### WARNINGS



It is extremely dangerous to ride in the cargo area, inside or outside of your vehicle. In a collision, people riding in these areas are more likely to be seriously injured or killed. Do not allow people to ride in any area of your vehicle that does not have seats and safety belts. Make sure everyone in your vehicle is in a seat and using a safety belt correctly.



Make sure to close and latch the liftgate to prevent drawing exhaust fumes into your vehicle. This will also prevent passengers and cargo from falling out. If you must drive with the liftgate open, keep the vents or windows open so outside air comes into your vehicle. Failure to follow this warning could result in serious personal injury.

---

**Note:** *Be careful when opening or closing the liftgate in a garage or other enclosed area to avoid damaging the liftgate.*

**Note:** *Do not hang anything (bike rack, etc.) from the spoiler, glass or liftgate. This could damage the liftgate and its components.*

**Note:** *Do not leave the liftgate open while driving. This could damage the liftgate and its components.*

## Opening and Closing the Liftgate

### To Open the Liftgate

See **Locking and Unlocking** (page 34).

# Security

---

## **PASSIVE ANTI-THEFT SYSTEM** (If Equipped)

### **Principle of Operation**

The system prevents someone from starting the engine with an incorrectly coded key.

### **Coded Keys**

If you lose a key, you can purchase a replacement from an authorized dealer. If possible, provide them with the key number from the tag provided with the original keys. You can also obtain extra keys from an authorized dealer.

**Note:** *Have all of your remaining keys erased and recoded if you lose a key. Have replacement keys coded together with recoding your remaining keys. See an authorized dealer for further information.*

**Note:** *Do not shield your keys with metal objects. This may prevent the receiver from recognizing a coded key.*

### **Arming the Engine Immobilizer**

When you switch the ignition off the engine immobilizer will arm automatically after a short time.

### **Disarming the Engine Immobilizer**

When you switch the ignition on the engine immobilizer will disarm automatically if a correctly coded key is used.

If you are unable to start the engine with a correctly coded key, have your vehicle checked by an authorized dealer.

## **ANTI-THEFT ALARM** (If Equipped)

The system will warn you of an unauthorized entry to your vehicle. It will be triggered if any door, the luggage compartment or the hood is opened without using the remote control.

The direction indicators will flash and the horn will sound if unauthorized entry is attempted while the alarm is armed.

Take all remote controls to an authorized dealer if there is any potential alarm problem with your vehicle.

### **Arming the Alarm**

**Note:** *If the alarm is armed and the luggage compartment door is released, the alarm will disarm. Once it is closed, the alarm will rearm.*

The alarm is ready to arm when there is not a key in the ignition and all side doors are closed. Lock the vehicle using the remote control to arm the alarm.

### **Disarming the Alarm**

Disarm the alarm by any of the following actions:

- Unlock the doors or release the luggage compartment with the remote control.
- Switch the ignition to on or start the vehicle with a valid key.
- Use a valid key in the driver's door to unlock the vehicle, then switch the ignition on within 12 seconds.

# Steering Wheel

## ADJUSTING THE STEERING WHEEL (If Equipped)

### WARNING



Do not adjust the steering wheel when your vehicle is moving.

**Note:** Make sure that you are sitting in the correct position. See **Sitting in the Correct Position** (page 72).



E176972

1. Unlock the steering column.
2. Adjust the steering wheel to the desired position.



E95179

3. Lock the steering column.

## AUDIO CONTROL (If Equipped)

Select the required source on the audio unit.

You can operate the following functions with the control:



# Steering Wheel

## Type 1

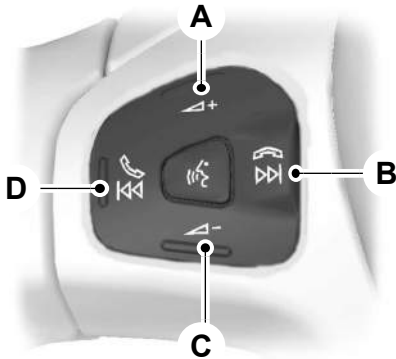

E164289

- A Volume up
- B Seek up, next or end call
- C Volume down
- D Seek down, previous or accept call

## Type 2

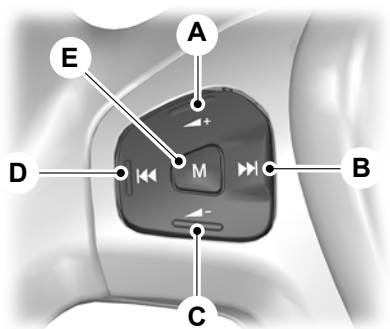

E164290

- A Volume up
- B Seek up or next
- C Volume down
- D Seek down or previous
- E Mode

Press **M** to select the audio source.

### Seek, Next or Previous

Press the seek button to:

- tune the radio to the next or previous stored preset.
- play the next or the previous track.

Press and hold the seek button to:

- tune the radio to the next station up or down the frequency band.
- seek through a track.

# Steering Wheel

---

## VOICE CONTROL (If Equipped)



E141533

Press the button to select or deselect voice control. See **SYNC™** (page 185).

Pressing seek up or seek down buttons will also cancel a voice session.

# Wipers and Washers

## WINDSHIELD WIPERS

**Note:** Fully defrost the windshield before switching on the windshield wipers.

**Note:** Make sure the windshield wipers are switched off before entering a car wash.

**Note:** Install new wiper blades as soon as they begin to leave bands of water and smears on the windshield.

**Note:** Do not operate the wipers on a dry windshield. This may scratch the glass, damage the wiper blades or cause the wiper motor to burn out. Always use the windshield washers before wiping a dry windshield.

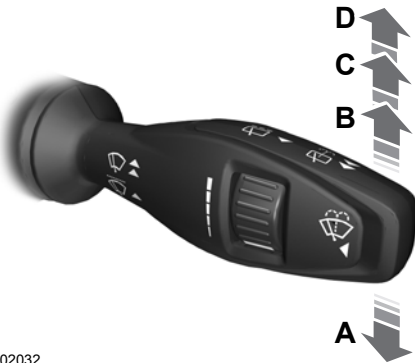

E102032

- A Single wipe
- B Intermittent wipe
- C Normal wipe
- D High speed wipe

**Note:** If you press and hold the wiper lever in position A, the wipers will continue to wipe until you release the wiper lever.

## Intermittent Wipe

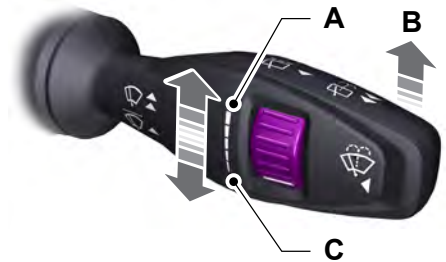

E102033

- A Short wipe interval
- B Intermittent wipe
- C Long wipe interval

Use the rotary control to adjust the intermittent wipe interval.

## WINDSHIELD WASHERS

**Note:** Do not operate the washers when the washer reservoir is empty. This may cause the washer pump to overheat.



E102051

Push the button to operate the washers. When you release the button, the wipers will operate for a short time.

# Wipers and Washers

## REAR WINDOW WIPER AND WASHERS - 5-DOOR

### Intermittent Wipe



E102052

Pull the lever toward you.

### Reverse Gear Wipe

The rear wiper will turn on automatically when selecting reverse gear if:

- The rear wiper is not already switched on.
- The wiper lever is in position A, B, C or D.

You can switch this feature off with the help of an authorized dealer.

**Note:** Do not hang anything, for example a bike rack, from the glass or liftgate. This may scratch the glass, damage the wiper blades or cause the wiper motor to burn out.

### Rear Window Washer

**Note:** Do not operate the washers when the washer reservoir is empty. This may cause the washer pump to overheat.

**Note:** Do not operate the washers for more than 10 seconds. This may cause the washer pump to overheat.



E102053

Pull the lever toward you to operate the windshield washers. When you release the lever, wiping will continue for a short period of time.

# Lighting

## LIGHTING CONTROL

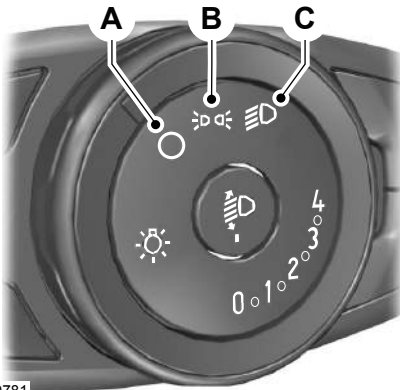

E140781

- A Off
- B Side and tail lamps
- C Headlamps

## High Beams



E208580

Push the lever forward to switch the high beams on.

Push the lever forward again or pull the lever toward you to switch the high beams off.

## Headlamp Flasher



E101829

Pull the lever toward you slightly and release it to flash the headlamps.

## Parking Lamps

**Note:** Prolonged use of the parking lamps when the ignition is off will cause the battery to run out of charge.

To operate the parking lamps turn the lighting control to position B. The parking lamps operate with the ignition on or off.

## HEADLAMP EXIT DELAY

After you switch the ignition off, you can switch the headlamps on by pulling the direction indicator lever toward you. You will hear a short tone. The headlamps will switch off automatically after three minutes with any door open or 30 seconds after the last door has been closed. You can cancel this feature by pulling the direction indicator toward you again or switching the ignition on.

# Lighting

## FRONT FOG LAMPS (If Equipped)

### Type 1

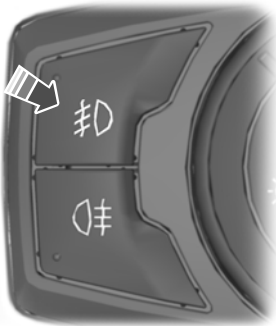

E208079

Press the control to switch the fog lamps on or off.

You can switch the fog lamps on when the lighting control is in any position except off.

**Note:** Your vehicle might be equipped with a fog lamp preparation pack. In such case, only the fog lamp switch will be available. You can purchase the fog lamps from an authorized dealer in order to get full functionality.

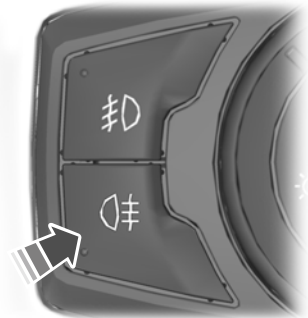

E203471

### Type 2



E209165

## REAR FOG LAMPS

### WARNINGS



Only use the rear fog lamps when visibility is restricted to less than 50 m.



Do not use the rear fog lamps when it is raining or snowing and visibility is more than 50 m.

Press the control to switch the fog lamps on or off.

You can switch the fog lamps on when either the front fog lamps or low beam headlamps are on.

**Note:** Your vehicle might be equipped with a fog lamp preparation pack. In such case, only the fog lamp switch will be available. You can purchase the fog lamps from an authorized dealer in order to get full functionality.

# Lighting

## HEADLAMP LEVELING (If Equipped)

1. Press to release the pop out button.



E132711

2. Rotate the button to the required setting.
3. Push the button to the closed position.

You can adjust the level of the headlamp beams according to the vehicle load.

## Recommended headlamp levelling switch positions

Load		Load in luggage compartment	Switch position
Front seats	Second row seats		
1	-	-	0
2	-	-	0
2	3	-	1.5
2	3	Max <sup>1</sup>	2
1	-	Max <sup>1</sup>	3

<sup>1</sup> See **Capacities and Specifications** (page 153).

# Lighting

## DIRECTION INDICATORS



E102016

Push the lever up or down to use the direction indicators.

**Note:** Tap the lever up or down to make the direction indicators flash three times to indicate a lane change.

## INTERIOR LAMPS

### Courtesy Lamp

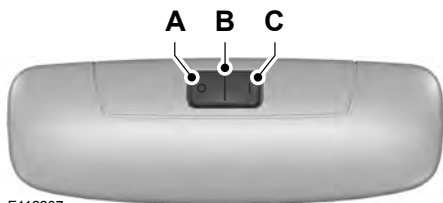

E112207

- A Off
- B Door contact
- C On

If you set the switch to position B, the courtesy lamp will illuminate when you unlock or open a door or the liftgate. If you leave a door open with the ignition switched off, the courtesy lamp will go off automatically after some time to prevent your vehicle battery from losing charge. To switch it back on, switch the ignition on for a short time.

The courtesy lamp will also illuminate when you switch the ignition off. It will go off automatically after a short time or when you start the engine.

If you set the switch to position C with the ignition switched off, the courtesy lamp will illuminate. It will go off automatically after a short time to prevent your vehicle battery from losing charge. To switch it back on, switch the ignition on for a short time.



# Windows and Mirrors

## POWER WINDOWS - VEHICLES WITH: ONE-TOUCH UP AND DOWN DRIVER WINDOW

### WARNINGS



Do not leave children unattended in your vehicle and do not let them play with the power windows. They may seriously injure themselves.



When closing the power windows, you should verify they are free of obstructions and make sure that children and pets are not in the proximity of the window openings.

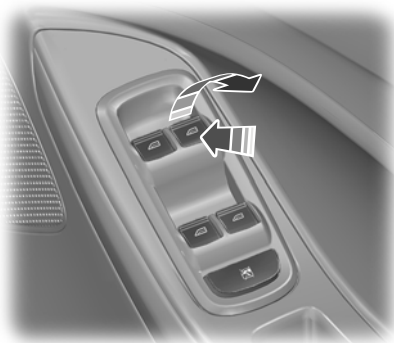

E208419

Press the control to open the window.

Lift the control to close the window.

**Note:** You may hear a pulsing noise when just one of the windows is open. Lower the opposite window slightly to reduce this noise.

### One-Touch Down (If Equipped)

Press the control fully and release it. Press again or lift it to stop the window.

### One-Touch Up (If Equipped)

Lift the control fully and release it. Press or lift it again to stop the window.

### Window Lock

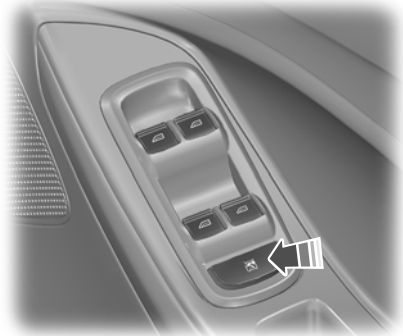

E208420

Press the control to lock or unlock the rear window controls. It illuminates when the rear window controls lock.

### Bounce-Back (If Equipped)

The window stops automatically while closing. It reverses some distance if there is an obstacle in the way.

### Overriding the Bounce-Back Feature

#### WARNING



When you override the bounce-back feature the window will not reverse if it detects an obstacle. Take care when closing the windows to avoid personal injury or damage to your vehicle.

Proceed as follows to override this protection feature when there is a resistance, for example in winter:

# Windows and Mirrors

1. Close the window twice until it reaches the point of resistance and let it reverse.
2. Close the window a third time to the point of resistance. The bounce-back feature is now disabled and you can close the window manually. The window will go past the point of resistance and you can close it fully.

Contact an authorized dealer as soon as possible if the window does not close after the third attempt.

## Resetting the Bounce-Back Feature

### WARNING



The bounce-back feature remains turned off until you reset the memory.

If you have disconnected the battery, you must reset the bounce-back memory separately for each window.

1. Lift and hold the control until the window is fully closed.
2. Release the control.
3. Lift and hold the control again for a few seconds.
4. Release the control.
5. Lift and hold the control again for a few seconds.
6. Release the control.
7. Press and hold the control until the window is fully open.
8. Lift and hold the control until the window is fully closed.
9. Release the control.
10. Open the window and then try to close it automatically.
11. Repeat the procedure if the window does not close automatically.

## EXTERIOR MIRRORS

### WARNING



Do not adjust the mirrors when your vehicle is moving. This could result in the loss of control of your vehicle, serious personal injury or death.

## Folding Mirrors

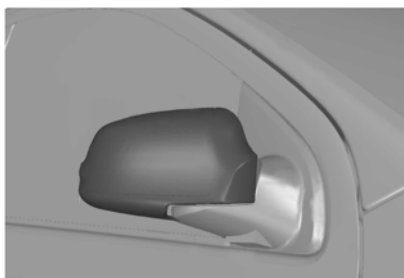

E102162

You can fold back your exterior mirror in narrow spaces or when the vehicle is parked to avoid accidental damage to the mirrors.

Make sure that you fully engage the mirror in its support when returning it to its original position.

### WARNING



Do not underestimate the distance of the objects that you see in the exterior mirror. Objects seen in the mirror will appear smaller and further away than they actually are.

# Windows and Mirrors

## Manual Exterior Mirrors

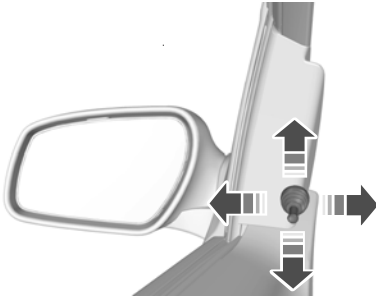

E123951

Both exterior mirrors are adjustable from inside the vehicle.

## Power Exterior Mirrors

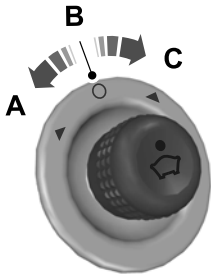

E71280

- A Left-hand mirror
- B Off
- C Right-hand mirror

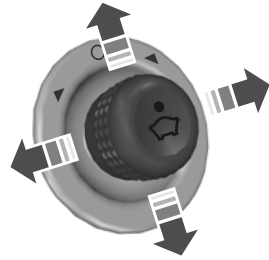

E71281

Move the controller in the direction of the arrows to adjust the mirror.

## Power Folding Mirrors (If Equipped)

### Folding and Unfolding

The power folding mirrors operate with the ignition on, and for several minutes after you switch the ignition off.

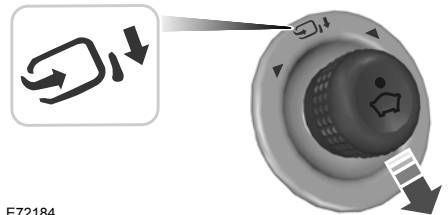

E72184

Move the controller downward to fold or unfold the mirrors.

**Note:** You can only fold the mirrors when the controller is set to position B.

Do not manually fold or unfold power folding mirrors as it is intended to be electrically operated. If inadvertently the mirror is folded or unfolded manually, return the mirror to the original position, and be sure that you fully engage the mirror in its support. On being manually folded or unfolded, if the power fold button is pressed, the mirrors may not perform the

# Windows and Mirrors

---

complete fold or unfold operation and stop in the middle of the folding range. In such an event, you may be required to press the power fold button two or three times in sequence to have the mirrors reset to normal folded or unfolded position.

**Note:** *Avoid operating the power fold mechanism several times in sequence as it may temporarily disable or damage the system.*

## INTERIOR MIRROR

### WARNING



Do not adjust the mirror when your vehicle is moving.

**Note:** *Do not clean the housing or glass of any mirror with harsh abrasives, fuel or other petroleum or ammonia-based cleaning products.*

You can adjust the interior mirror to your preference.

Pull the tab below the mirror toward you to reduce glare at night.

# Instrument Cluster

## GAUGES

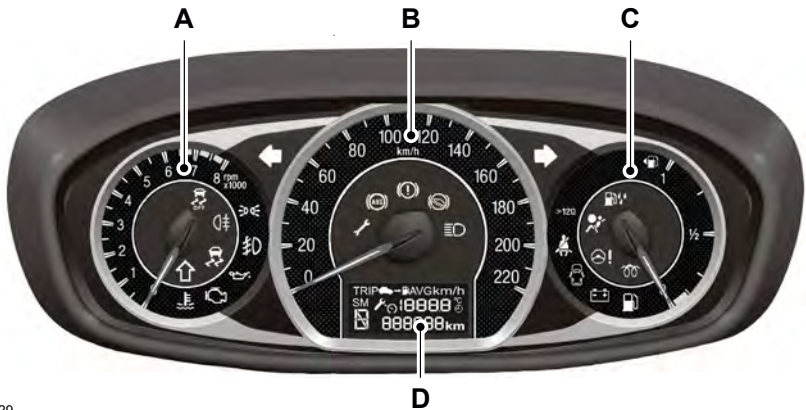

E203829

- A Tachometer
- B Speedometer
- C Fuel gauge
- D Information display

### Tachometer

Indicates the engine speed in revolutions per minute. Driving with your tachometer pointer continuously above speed limits may damage the engine.

### Information Display

- Odometer.
- Trip odometer.
- Gear shift indicator.
- Distance to Empty (if equipped).
- Average fuel economy (if equipped).
- Instantaneous fuel economy (if equipped).
- Average speed (if equipped).

- Outside air temperature (if equipped).
- Trip Computer. See **Trip Computer** (page 59).

### Fuel Gauge

Switch the ignition on. The fuel gauge will indicate approximately how much fuel is left in the fuel tank. The fuel gauge may vary slightly when your vehicle is moving or on a gradient. The arrow adjacent to the fuel pump symbol indicates on which side of the vehicle the fuel filler door is located.

# Instrument Cluster

## Maximum Engine Speed

The electronic management system, under certain conditions, limits the engine speed below a preset value, in order to avoid engine damage. This speed limit can occur at a lower value when the vehicle is stopped or during speeds less than 10 km/h, not being considered as an engine failure.

### WARNING



When the engine is running, keep clothing, such as neckties, and any other objects away from the rotating engine components in order to avoid serious injuries.

## WARNING LAMPS AND INDICATORS

The following warning lamps and indicators will alert you to a vehicle condition that may become serious. Some lamps will illuminate when you start your vehicle to make sure they work. If any lamps remain on after starting your vehicle, refer to the respective system warning lamp for further information.

**Note:** *Some warning indicators appear in the information display and function the same as a warning lamp but do not display when you start your vehicle.*

### Anti-Lock Brake System Warning Lamp (If Equipped)



If it illuminates when you are driving, this indicates a malfunction. You will continue to have the normal braking system (without anti-lock brake system) unless the brake system warning lamp is also illuminated. Have your vehicle checked by an authorized dealer.

### Battery Warning Lamp



If it illuminates when driving, this indicates a malfunction. Switch off all unnecessary electrical equipment. Have your vehicle checked by an authorized dealer immediately.

### Brake System Warning Lamp



It will illuminate when you engage the parking brake with the ignition on.

If it illuminates when you are driving, check that the parking brake is not engaged. If the parking brake is not engaged, this indicates a system malfunction. Have your vehicle checked by an authorized dealer immediately.

### WARNING



Driving your vehicle with the warning lamp on is dangerous. A significant decrease in braking performance may occur. It will take you longer to stop your vehicle. Have your vehicle checked by an authorized dealer immediately. Driving extended distances with the parking brake engaged can cause brake failure and the risk of personal injury.

### Direction Indicator



Illuminates when the left or right direction indicator or the hazard warning flasher is turned on. If the indicators stay on or flash faster, check for a burnt out bulb. See **Changing a Bulb** (page 134).

### Door Ajar Warning Lamp (If Equipped)



Illuminates when you switch the ignition on and remains on if any door, the hood or the liftgate is not closed properly.

# Instrument Cluster

## Engine Coolant Temperature Warning Lamp

### WARNING



Do not resume your journey if it illuminates despite the level being correct. Have your vehicle checked by an authorized dealer immediately.



If it stays on after starting or illuminates when driving, this indicates a malfunction. Stop your vehicle as soon as it is safe to do so and switch the engine off. Check the coolant level. See **Engine Coolant Check** (page 128).

## Engine Oil Warning Lamp

### WARNING



Do not resume your journey if it illuminates despite the level being correct. Have your vehicle checked by an authorized dealer immediately.



If it illuminates with the engine running or when you are driving, this indicates a malfunction. Stop your vehicle as soon as it is safe to do so and switch the engine off. Check the engine oil level. See **Engine Oil Check** (page 127).

## Engine Warning Lamps



Malfunction Indicator Lamp



Powertrain Malfunction Warning Lamp

## All Vehicles

If either lamp illuminates when the engine is running, this indicates a malfunction. The engine will continue to run but it may have limited power. If it flashes when you are driving, reduce the speed of your vehicle immediately. If it continues to flash, avoid heavy acceleration or deceleration. Have your vehicle checked by an authorized dealer immediately.

### WARNING



Have this checked immediately.

If both lamps illuminate together, stop your vehicle as soon as it is safe to do so (continued use may cause reduced power). Switch the ignition off and attempt to restart the engine. If the engine restarts have your vehicle checked by an authorized dealer immediately. When the engine does not restart have your vehicle checked before continuing your journey.

## Front Airbag Warning Lamp (If

Equipped)



If it fails to illuminate when you start your vehicle, continues to flash or remains on, it indicates a malfunction. Have your vehicle checked by an authorized dealer.

## Front Fog Lamps Indicator (If Equipped)



It will illuminate when you switch the front fog lamps on.

## Fuel Heater Indicator (If Equipped)



If it illuminates, wait until it extinguishes before starting. If it flashes, switch the ignition off and then back on again. Wait until it extinguishes before starting.

# Instrument Cluster

## Headlamp Indicator



It will illuminate when you switch the headlamp dipped beam or the side and tail lamps on.

## High Beam Indicator



It will illuminate when you switch the high beam headlamps on. It will flash when you use the headlamp flasher.

## Hill Start Assist (If Equipped)



If it illuminates when you are driving, this indicates a malfunction.

## Low Fuel Level Warning Lamp



If it illuminates, refuel as soon as possible.

## Malfunction Indicator Lamp

The service engine soon indicator light illuminates when you switch the ignition on prior to engine start to check the bulb.



If it remains illuminated after you start the engine, it indicates that the on board diagnostics system has detected a malfunction to the emissions control system.

If it flashes, engine misfire is occurring which could damage your catalytic converter. Drive in a moderate fashion (avoid heavy acceleration and deceleration) and have your vehicle serviced immediately.

**Note:** *Under engine misfire conditions, excessive exhaust temperatures could damage the catalytic converter or other vehicle components.*

## Over Speed Warning (If Equipped)



It will illuminate if the vehicle exceeds 120km/h.

## Power Steering



If it illuminates when driving, this indicates a malfunction of the power steering system. You will continue to have full steering but will need to exert greater force on the steering wheel. Have the system checked by an authorized dealer as soon as possible.

## Rear Fog Lamp



It will illuminate when you switch the rear fog lamps on.

## Scheduled Maintenance Indicator Lamp (If Equipped)



It will illuminate when your vehicle has reached the mileage or time (whichever occurs first) for your scheduled maintenance items to be performed according to the scheduled maintenance tables.

## Seat belt reminder



See **Seatbelt Reminder** (page 24).

## Shift Indicator (If Equipped)



It will illuminate to inform you that shifting to a higher gear may give better fuel economy and lower CO<sub>2</sub> emissions. It will also illuminate to inform you that the engine is approaching maximum speed.



# Instrument Cluster

---

## **Traction and Stability Control Indicator** (If Equipped)



While driving, it flashes when the system is operating. After you switch the ignition on, if it does not illuminate or illuminates continuously while driving, this indicates a malfunction. During a malfunction, the system switches off. Have your vehicle checked by an authorized dealer as soon as possible.

## **Traction and Stability Control Off** (If Equipped)



It will illuminate when you switch the system off. It will go out when you switch the system back on or when you switch the ignition off.

## **Water-In-Fuel** (If Equipped)



It will illuminate if there is excess water in the fuel filter. Drain off the water immediately. See **Draining the Fuel Filter Water Trap** (page 130).

## **AUDIBLE WARNINGS AND INDICATORS**

### **Door Ajar** (If Equipped)

Sounds if the vehicle's speed exceeds the pre-determined limit and any of the doors are open or ajar. The chime will only sound once per ignition key cycle.

### **Headlamps On** (If Equipped)

Sounds when you turn the key to off and open the driver's door and you have left the headlamps or parking lamps on.

### **Vehicle not in Park**

Sounds when the door is opened and the vehicle is not in Park position.

### **Safety Belt Minder** (If Equipped)

Sounds when the vehicle's speed exceeds the pre-determined limit, and the safety belts are unfastened.

### **Parking Brake**

Sounds when the vehicle's speed exceeds the pre-determined limit with the parking brake engaged. It will stop as soon as the vehicle is stopped or the parking brake is released.

### **Airbag Indicator Lamp Malfunction** (If Equipped)

Sounds when the airbag indicator lamp is inoperable.

# Information Displays

## GENERAL INFORMATION

### WARNING



Driving while distracted can result in loss of vehicle control, crash and injury. We strongly recommend that you use extreme caution when using any device that may take your focus off the road. Your primary responsibility is the safe operation of your vehicle. We recommend against the use of any hand-held device while driving and encourage the use of voice-operated systems when possible. Make sure you are aware of all applicable local laws that may affect the use of electronic devices while driving.

Various systems on your vehicle can be controlled using the information display controls on your audio unit. Corresponding information is displayed in the information display.

### Information Display Controls (if

Equipped)



E103626

- Press the up and down arrow buttons to scroll through and highlight the options within a menu.
  - Press the right arrow button to enter a sub-menu.
- Press the left arrow button to exit a menu.
  - Press the **OK** button to choose and confirm settings or messages.
- Press the **MENU** button on the radio to access some configurable features. Use the control arrow to the following features:
- SYNC-config. Access general SYNC configurations. See **SYNCTM** (page 185).
  - SYNC-applications. Access SYNC applications. See **SYNCTM** (page 185).
  - Audio configuration. Defines the audio configurations. See **Audio Unit** (page 167).
  - Vehicle configurations. Allow you to configure these features:
    - Traction control. You can activate or deactivate traction control. See **Principle of Operation** (page 94).
  - Clock. Allows you to adjust the time and date.
  - Display. Allows you to set the language on the display and in the voice recognition system.
  - System. Allows you to see current active information messages.
- ### Adjusting the Clock
1. Press the **MENU** button on the radio.
  2. Select **Clock** then press **OK**.
  3. Select **Adjust Clock** then press **OK**.
  4. Use the up or down arrows to increase or decrease the hour and minutes.
  5. Use the left or right arrows to alternate between hour or minute adjustment.
  6. Press **OK** when done.
- or
1. Press the **#** symbol on the radio to access the clock adjustment.

# Information Displays

2. Use the up or down arrows to increase or decrease the hour and minutes.
3. Use the left or right arrows to alternate between hour or minute adjustment.
4. Press **OK** when done.

## Adjusting the Date

1. Press the **MENU** button on the radio.
2. Select **Clock** then press **OK**.
3. Select **Adjust Date** then press **OK**.
4. Use the up or down arrows to increase or decrease the day, month and year.
5. Use the left or right arrows to alternate between day, month and year adjustment.
6. Press **OK** when done.

## 24 Hour Mode

1. Press the **MENU** button on the radio.
2. Select **Clock** then press **OK**.
3. Choose **24h Mode**.
4. Check the selection box with the **OK** button to enable 24h mode or uncheck to enable 12h mode.

## Menu Structure - Information Display (If Equipped)

You can access the menu using the information display control.

**Note:** Some options may appear slightly different or not at all if the items are optional.

Menu		
Radio menu		
SYNC-Settings	Bluetooth on	
	Bluetooth device	
	Set defaults	
	Master reset	
	Install on SYNC	
	System info	
	Voice settings	
	Browse USB	
SYNC-Applications		
Audio settings	Adaptive vol.	
	Sound	
	DSP occupancy	
	DSP equalizer	
Vehicle settings	Chimes	Info chimes

# Information Displays

<b>Menu</b>		
	Warning chimes	
Clock settings	Set time	
	Set date	
	24-hour mode	
Display settings	Language	
System check		
MyKey	Speed limit	
	Speed warning	Off
		70-140 km/h
	Volume limit	
	Information	
Clear all MyKeys		

<b>SYNC-Phone</b>	
	Dial a number
	Redial
	Phonebook
	Call history
	Speed Dial
	Text messaging
	BT Devices
	Phone settings

# Information Displays

## TRIP COMPUTER



E146272

Press the button to scroll through the displays:

- Odometer.
- Trip odometer.
- Distance to Empty.
- Average fuel economy.
- Instantaneous fuel economy.
- Average speed.
- Outside air temperature.
- Gear shift indicator.

You can reset the trip odometer, average fuel economy and average speed. To do this, scroll to the required display, then press and hold the button until the screen appears completely full with dashes.

The trip computer includes the following information displays:

### Odometer

Registers the total distance of the vehicle.

### Trip Odometer

Registers the distance traveled since the function was last reset.

### Distance to Empty (If Equipped)

Indicates the approximate distance your vehicle will travel on the fuel remaining in the tank. Changes in driving pattern may cause the value to vary.

### Average Fuel Economy (If Equipped)

Indicates the average fuel economy since the function was last reset.

### Instantaneous Fuel Economy (If Equipped)

Indicates the current fuel economy.

### Average Speed (If Equipped)

Indicates the average speed calculated since the function was last reset.

### Outside Ambient Temperature Indication (If Equipped)

This will display the outside ambient temperature in degrees Celsius.

### Shift Indicator (If Equipped)

Indicates when to shift gear up to drive more economically.

### Enabling and Disabling the Shift Indicator

1. Press the **TRIP** button until **ECONO** displays on the screen.
2. Press and hold it for more than two seconds until **ECONO ON** displays to enable it.
3. Press and hold it for more than two seconds until **ECONO OFF** displays to disable it.

After enabling the shift indicator, the indicator light illuminates for 3 seconds.

## PERSONALIZED SETTINGS

### Measure Units

To swap between imperial and metric units, scroll to this display and press the **OK** button.

# Information Displays

Swapping between imperial and metric units will affect the following displays:

- Distance to empty.
- Average fuel economy.
- Instantaneous fuel economy.
- Average speed.

## INFORMATION MESSAGES (if

Equipped)

**Note:** Depending on the vehicle options equipped with your vehicle, not all of the messages will display or be available. Certain messages may be abbreviated or shortened depending upon which multi function display type your vehicle may be equipped with.



E103626

Press the OK button to acknowledge and remove some messages from the information display. Other messages will be removed automatically after a short time.

Certain messages need to be confirmed before you can access the menus.

 The message indicator illuminates to supplement some messages. It will be red or amber depending on the severity of the message and will remain on until the cause of the message has been rectified.

Some messages will be supplemented by a system specific symbol with a message indicator.

## Airbag

Message	Message indicator	Action
Airbag malfunction Service now	amber	Have the system checked by an authorized dealer as soon as possible.

# Information Displays

## Doors Open

<b>Message</b>	<b>Message indicator</b>	<b>Action</b>
Driver door open	red	Vehicle is moving. Stop your vehicle as soon as safely possible and close.
Driver side rear door open	red	Vehicle is moving. Stop your vehicle as soon as safely possible and close.
Passenger door open	red	Vehicle is moving. Stop your vehicle as soon as safely possible and close.
Passenger side rear door open	red	Vehicle is moving. Stop your vehicle as soon as safely possible and close.
Trunk open	red	Vehicle is moving. Stop your vehicle as soon as safely possible and close.
Driver door open	amber	Vehicle not moving. Close.
Driver side rear door open	amber	Vehicle not moving. Close.
Passenger door open	amber	Vehicle not moving. Close.
Passenger side rear door open	amber	Vehicle not moving. Close.
Trunk open	amber	Vehicle not moving. Close.

# Information Displays

## MyKey

Message	Message indicator	Action
MyKey active Drive Safely	-	Displays when MyKey is active.
My Key Speed limited to <XX> mph	-	When switching on your vehicle and MyKey is in use, displays that the MyKey speed limit is on.
MyKey Check speed Drive safely	amber	Displays when MyKey is active.
MyKey Vehicle near top speed	amber	MyKey is in use, the MyKey speed limit is on and your vehicle speed is approaching 130 km/h.
MyKey Vehicle at top speed	amber	You have reached the speed limit set for your MyKey.

## ESP

Message	Message indicator	Action
Traction control off	-	The status of the traction control system after you switched it off

## Maintenance

Message	Message indicator	Action
Brake fluid level low service now	red	See <b>Brake Fluid Check</b> (page 129).
Brake system malfunction stop safely	red	Have the system checked by an authorized dealer immediately.
Engine malfunction service now	amber	Have the system checked by an authorized dealer as soon as possible.



# Information Displays

## Steering

Message	Message indicator	Action
Steering lock malfunction stop safely	red	Have the system checked by an authorized dealer immediately.
Steering assist fault service required	amber	Full steering will be maintained but you will need to exert greater force on the steering wheel. Have the system checked by an authorized dealer as soon as possible.

## Transmission

Message	Message indicator	Action
Transmission malfunction Service now	red	Have the system checked by an authorized dealer immediately.
Transmission overtemperature Stop safely	red	Under certain driving conditions it is possible that the clutches in the transmission can overheat. In these circumstances it is necessary to press the brake pedal and stop your vehicle to prevent damages to the transmission. Select N or P and apply the parking brake until the transmission has cooled and the message disappears from the display.
Vehicle not in Park Select P	-	See <b>Automatic Transmission</b> (page 88). See <b>Starting and Stopping the Engine</b> (page 79).
Select N or P to start	-	See <b>Automatic Transmission</b> (page 88). See <b>Starting and Stopping the Engine</b> (page 79).

## Information Displays

Message	Message indicator	Action
Press brake to start	-	See <b>Starting and Stopping the Engine</b> (page 79).
Select N to start	-	See <b>Automatic Transmission</b> (page 88). See <b>Starting and Stopping the Engine</b> (page 79).
Door open Apply brake	-	See <b>Automatic Transmission</b> (page 88). See <b>Starting and Stopping the Engine</b> (page 79).

### Stability Control

Message	Message indicator	Action
ABS malfunction service now	amber	Have the system checked by an authorized dealer as soon as possible.
Sport mode	-	Have the system checked by an authorized dealer.
AdvanceTrac off	-	See <b>Using Stability Control</b> (page 95).

# Climate Control

## PRINCIPLE OF OPERATION

### Outside Air

Keep the air intakes in front of the windshield free from obstruction (such as snow or leaves) to allow the climate control system to function effectively.

### Recirculated Air

#### WARNING



Prolonged use of recirculated air may cause the windows to mist up. If the windows mist up, follow the settings for demisting the windshield.

The air currently in the passenger compartment recirculates. Outside air does not enter your vehicle.

### Heating

Heating performance depends on the temperature of the engine coolant.

### General Information on Controlling the Interior Climate

Fully close all the windows.

### Warming the Interior

Direct the air toward your feet. In cold or humid weather conditions, direct some of the air toward the windshield and the door windows.

### Cooling the Interior

Direct the air toward your face.

## Air Conditioning

The system directs air through the evaporator for cooling. The evaporator extracts humidity from the air to help keep the windows free of mist. The system directs the resulting condensation to the outside of your vehicle, which may cause a small pool to form under your vehicle. This is normal.

**Note:** The air conditioning operates only when the temperature is above 4°C.

**Note:** When you use air conditioning, your vehicle uses more fuel.

## AIR VENTS

### Center Air Vents

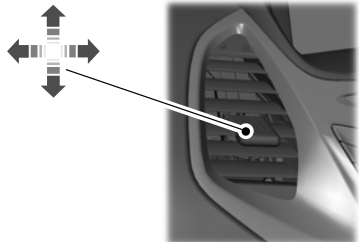

E174289

### Side Air Vents



E71942

# Climate Control

## MANUAL CLIMATE CONTROL

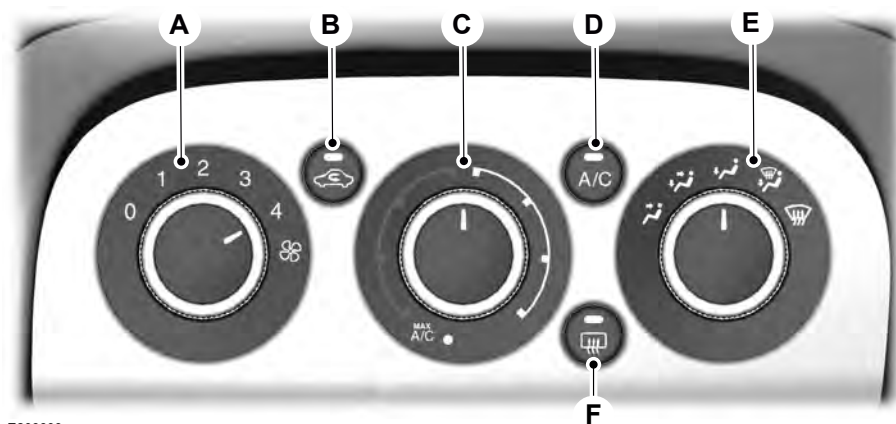

E206609

- A **Fan speed control:** Controls the volume of air circulated in your vehicle. Adjust to select the desired fan speed or switch off. If you switch the fan off, the windshield may fog up.
- B **Recirculated air:** Press the button to switch between outside air and recirculated air. When you select recirculated air, the button illuminates and the air currently in the passenger compartment recirculates. This can reduce the time needed to cool the interior and reduce unwanted odors from entering your vehicle.
- C **Temperature control:** Controls the temperature of the air circulated in your vehicle. Adjust to select the desired temperature. If you select **MAX A/C**, the recirculated air and **A/C** is automatically turned on and the temperature is set to minimum. If **A/C** or recirculated air are turned off, the **MAX A/C** function is automatically turned off.
- D **Air conditioning:** Press the button to switch the air conditioning on or off. Air conditioning cools your vehicle. In hot days, to improve the performance of the air conditioning drive with the windows slightly open for the first two or three minutes.
- E **Air distribution control:** Adjust to select the desired air distribution.
- F **Heated rear window:** Turn the heated rear window on and off. See **Heated Windows** (page 71).

# Climate Control



Select to distribute air through the instrument panel air vents.



Select to distribute air through the instrument panel and footwell air vents.



Select to distribute air through the footwell air vents.



Select to distribute air through the windshield and footwell air vents.



Select to distribute air through the windshield air vents. You can also use this setting to defog and clear the windshield of a thin covering of ice. You can also increase the temperature and fan speed to improve clearing.

**Note:** When defrost mode is selected, the AC will turn on automatically.

## AUTOMATIC CLIMATE CONTROL

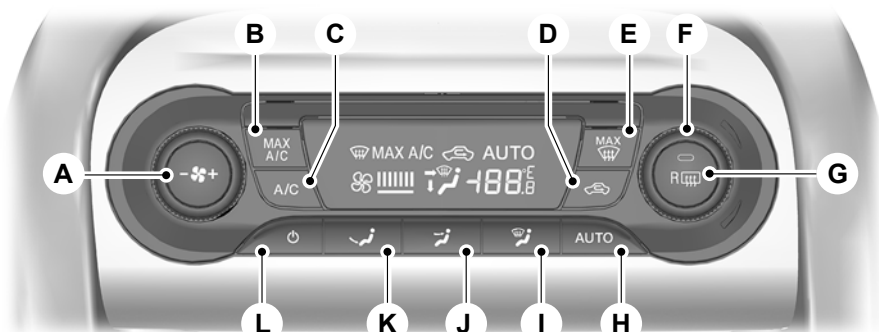

E203686

- A **Fan speed:** Controls the volume of air circulated in your vehicle. Rotate the control to select the desired fan speed. The setting appears in the display.
- B **MAX A/C:** Press the button to distribute maximum air conditioning through the instrument panel air vents. This mode is more efficient than normal air conditioning.
- C **Air conditioning:** Press the button to switch the air conditioning on or off. In hot days, to improve air conditioning when starting your vehicle drive with the windows slightly open for two to three minutes. In certain condition (for example defrost), the AC compressor may continue to operate even though the AC is switched off.

# Climate Control

---

- D **Recirculated air:** Press the button to switch between outside air and recirculated air. The air currently in the passenger compartment recirculates. This can reduce the time needed to cool the interior and reduce unwanted odors from entering your vehicle.
- E **MAX Defrost:** This mode quickly defogs the windshield. Press the button to distribute outside air through the windshield air vents. Air conditioning is automatically selected. The fan is set to the highest speed and the temperature to HI. Press the AUTO button to return to auto mode.
- F **Temperature control:** Controls the temperature of the air circulated in your vehicle. Adjust to select the desired temperature. The setting appears in the display.  
**Note:** The human body's comfortable temperature is between 21°C and 27°C, please set the temperature within a reasonable range.
- G **Heated rear window:** Turns the heated rear window on and off. See **Heated Windows** (page 71).
- H **AUTO:** Press the button to select automatic operation. The system automatically controls the temperature, amount and distribution of the airflow to reach and maintain your previously selected temperature.
- I **Defrost:** Press the button to distribute air to the windshield vents and de-mister. You can use this setting to defog and clear the windshield of a thin covering of ice. When defrost mode is switched on, the AC will turn on automatically.
- J **Instrument panel:** Press the button to distribute air through the instrument panel air vents.
- K **Footwell:** Press the button to distribute air through the footwell air vents.
- L **On and off button:** Press the button to switch the system on and off.

## HINTS ON CONTROLLING THE INTERIOR CLIMATE

### General Hints

**Note:** Prolonged use of recirculated air may cause the windows to fog up.

**Note:** You may feel a small amount of air from the footwell air vents regardless of the air distribution setting.

**Note:** To reduce humidity build-up inside your vehicle, do not drive with the system switched off or with recirculated air always switched on.

**Note:** Do not place objects under the front seats as this may interfere with the airflow to the rear seats.

**Note:** Remove any snow, ice or leaves from the air intake area at the base of the windshield.

To minimize humidity in the air conditioning system and reduce unpleasant odors, switch off the air conditioning and keep the fan going for at least two minutes before switching off the engine. Do the following:

1. Keep the engine running.
2. Switch off the air conditioning by pressing the **A/C** button.

# Climate Control

3. Keep the fan switched on.
4. Set the temperature to the full hot position.
5. Use outside air, not recirculated air.
6. Wait one to two minutes, and then switch off the engine.

## Heating the Interior Quickly

	Vehicle with manual climate control	Vehicle with automatic climate control
1	Adjust the fan speed to the highest speed setting.	Adjust the fan speed to the highest speed setting.
2	Adjust the temperature control to the highest setting.	Adjust the temperature control to the highest setting.
3	Adjust the air distribution control to the footwell air vents position.	Press the footwell button to distribute air to the footwell air vents.

## Recommended Settings for Heating

	Vehicle with manual climate control	Vehicle with automatic climate control
1	Adjust the fan speed to the second speed setting.	Press the <b>AUTO</b> button.
2	Adjust the temperature control to the midway point of the hot settings.	Adjust the temperature control setting to the desired setting.
3	Adjust the air distribution control to the footwell and windshield air vents position.	

## Cooling the Interior Quickly

	Vehicle with manual climate control	Vehicle with automatic climate control
1	Adjust the fan speed to the highest speed setting.	Press the <b>AUTO</b> button.
2	Adjust the temperature control to the <b>MAX A/C</b> position.	Adjust the temperature control setting to low.
3	Adjust the air distribution control to the instrument panel air vents position.	

# Climate Control

## Recommended Settings for Cooling

	Vehicle with manual climate control	Vehicle with automatic climate control
1	Adjust the fan speed to the second speed setting.	Press the <b>AUTO</b> button.
2	Adjust the temperature control to the midway point of the cold settings.	Adjust the temperature control to the desired setting.
3	Adjust the air distribution control to the instrument panel air vents position.	Open all instrument panel air vents and direct as desired.

## Vehicle Stationary for Extended Periods during Extreme High Ambient Temperatures

	Vehicle with manual climate control	Vehicle with automatic climate control
1	Apply the parking brake.	Apply the parking brake.
2	Move the transmission selector lever to position <b>P</b> (automatic transmission) or neutral (manual transmission).	Move the transmission selector lever to position <b>P</b> (automatic transmission) or neutral (manual transmission).
3	Adjust the fan speed to the desired setting.	Press the <b>AUTO</b> button.
4	Adjust the temperature control to the <b>MAX A/C</b> position.	Adjust the temperature control setting to low.
5	Adjust the air distribution control to the instrument panel air vents position.	Adjust the air distribution control to the instrument panel air vents position.

## Windshield and Side Window Defrosting or Defogging in Cold Weather

	Vehicle with manual climate control	Vehicle with automatic climate control
1	Press the windshield defrosting and defogging button.	Press the maximum windshield defrosting and defogging button.
2	Adjust the temperature control to the desired setting.	Adjust the temperature control to the desired setting.
3	Direct the outboard instrument panel air vents toward the side windows.	Direct the outboard instrument panel air vents toward the side windows.
4	Adjust the fan speed to the highest setting.	



# Climate Control

---

## HEATED WINDOWS (If Equipped)

**Note:** *Make sure that the engine is running before switching the heated rear window on.*

### Heated Rear Window



Press the button to clear the heated rear window of thin ice and fog. Press the button to switch the system off. It switches off automatically after 10 minutes, or when you switch the ignition off.

**Note:** *Do not use razor blades or other sharp objects to clean or remove decals from the inside of the heated rear window. The vehicle warranty does not cover damage caused to the heated rear window grid lines.*

## CABIN AIR FILTER

Your vehicle is equipped with a cabin air filter. It is located behind the center console.

The particulate filtration system reduces the concentration of airborne particles such as dust, spores and pollen in the air supplied to the interior of your vehicle.

**Note:** *Make sure you have a cabin air filter installed at all times. This prevents foreign objects from entering the system. Running the system without a filter in place could result in degradation or damage to the system.*

The particulate filtration system gives you and your passengers the following benefits:

- It improves your driving comfort by reducing particle concentration.
- It improves the interior compartment cleanliness.
- It protects the climate control components from particle deposits.

Replace the filter at regular intervals.

For additional cabin air filter information, or to replace the filter, see an authorized dealer.

# Seats

## SITTING IN THE CORRECT POSITION

### WARNINGS



Sitting improperly, out of position or with the seat back reclined too far can take weight off the seat cushion and affect the decision of the passenger sensing system, resulting in serious injury or death in the event of a collision. Always sit upright against your seat back, with your feet on the floor.



Do not recline the seat back as this can cause the occupant to slide under the safety belt, resulting in serious injury in the event of a collision.



Do not place objects higher than the seat back to reduce the risk of serious injury in the event of a collision or during heavy braking.

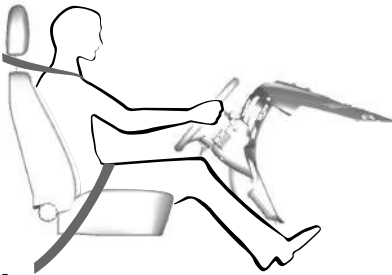

E68595

The correct use of these components provide better protection for the occupants in case of accident.

### WARNING



Never adjust the seats when the vehicle is moving.

**Note:** The seat belt must be used properly to hold the body in a position to allow the airbag to achieve maximum effect.

### Correct Driving Position

- Sit in the most vertical position possible, and with the seat backrest not reclined by more than 30 degrees.
- Adjust the head restraints.
- Do not place the front seat much too close to the dashboard. The same applies to the front passenger.
- The driver should hold the steering wheel with the arms slightly bent, as well as the legs, so that the pedals can be fully pressed.
- Position the shoulder strap of the safety belt over the center of your shoulder and position the lap strap tightly across your hips.

Make sure that your driving position is comfortable and that you can maintain full control of your vehicle.

## HEAD RESTRAINTS

### WARNINGS



Fully adjust the head restraint before you sit in or operate your vehicle. This will help minimize the risk of neck injury in the event of a collision. Do not adjust the head restraint when your vehicle is moving.



The head restraint is a safety device. Whenever possible it should be installed and properly adjusted when the seat is occupied.



Install the head restraint properly to help minimize the risk of neck injury in the event of a collision.

# Seats

**Note:** Adjust the seat back to an upright driving position before adjusting the head restraint. Adjust the head restraint so that the top of it is level with the top of your head and as far forward as possible. Make sure that you remain comfortable. If you are extremely tall, adjust the head restraint to its highest position.

## Front Head Restraints

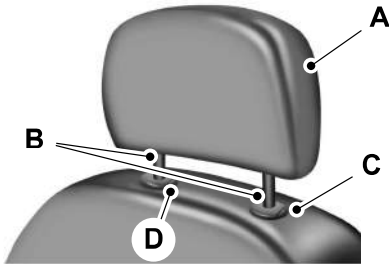

E138642

## Rear Head Restraints (if equipped)

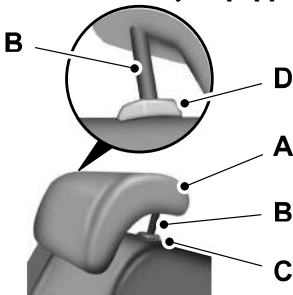

E138645

The head restraints consist of:

- A An energy absorbing head restraint
- B Two steel stems
- C Guide sleeve adjust and unlock button
- D Guide sleeve unlock and remove button

## Adjusting the Head Restraint

### Raising the Head Restraint

Pull the head restraint up.

### Lowering the Head Restraint

1. Press and hold button C.
2. Push the head restraint down.

### Removing the Head Restraint

1. Pull the head restraint up until it reaches its highest position.
2. Press and hold buttons C and D.
3. Pull the head restraint up.

### Installing the Head Restraint

Align the steel stems into the guide sleeves and push the head restraint down until in locks.

## MANUAL SEATS

### WARNING

 Do not adjust the driver seat when your vehicle is moving. This may result in the loss of control of your vehicle, serious personal injury or death.

### Moving the Seat Backward and Forward

### WARNING

 Rock the seat backward and forward after releasing the lever to make sure that it is fully engaged in its catch. A seat which is not fully engaged in its catch could move when your vehicle is moving. This may result in the loss of control of your vehicle, serious personal injury or death.

# Seats



E206610

## Adjusting the Height of the Driver Seat (If Equipped)



E176806

## Recline Adjustment



E176807

## REAR SEATS

### Reclining the Seat Back (If Equipped)

Your vehicle may have split seat backs that can be folded individually.

### Folding the Seat Backrest (If Equipped)

#### WARNINGS

-  Do not use the bench seats as a bed when your vehicle is moving. Failure to follow this warning could result in serious personal injury or death.
-  When folding or unfolding the seats, take care not to get your fingers caught between the seat backrest and seat frame. Failure to follow this warning could result in serious personal injury.
-  Do not place any objects on a folded seat. Hard objects may become projectiles in a crash or sudden stop, which may increase the risk of serious personal injury.
-  Do not attempt to fold the rear seat cushion forward before folding the seat backrest.

# Seats

Lower the head restraints. See **Head Restraints** (page 72).

## Type 1



E208574

1. With the seat unoccupied, push the button shown on both the sides of the seat to fold the seatback flat.
2. Fold the seat backrest forward.

## Type 2





E208132

1. With the seat unoccupied, push the button shown on both the sides of the seat to fold the seatback flat.

2. Fold the seat backrest forward.

## Unfolding the Seat Backrest

### WARNINGS

-  When folding the seat backs up, make sure that the belts are visible to an occupant and not caught behind the seat.
-  Make sure that the seats and the seat backrests are secure and fully locked in their catches.

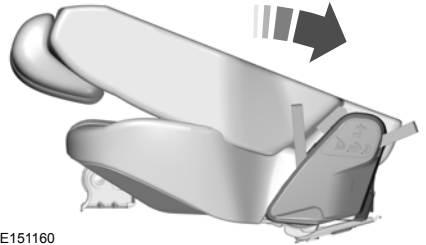

E151160

Lift the seatback toward the rear of the vehicle, and rotate the seatback until you hear a click, locking it in the upright position.

# Auxiliary Power Points

## WARNING



Incorrect use of the power points can cause damage not covered by the vehicle warranty, and can result in fire or serious injury.

**Note:** You can use the socket to power 12 volt appliances with a maximum current rating of 10 amps.

**Note:** Do not insert objects other than an accessory plug into the power point. This will damage the outlet and blow the fuse.

**Note:** Do not hang any type of accessory or accessory bracket from the plug.

**Note:** Do not use the power point for operating a cigar lighter element.

**Note:** Always keep the power point caps closed when not in use.

Run the engine for full capacity use of the power point. To prevent the battery from being discharged:

- Do not use the power point longer than necessary when the engine is not running.
- It is strongly recommended that you always disconnect the accessories from the power point (12 volt) when leaving the vehicle.

## Location

A power point may be found:



E174664

# Storage Compartments

## CUP HOLDERS

**Note:** Stow items in the cupholder carefully as items may become loose during hard braking, acceleration or crashes, including hot drinks which may spill.

### WARNING



Use only soft cups in the cup holders. Hard objects can injure you in a crash.

## CENTER CONSOLE

Your vehicle may be equipped with a variety of console features. These include:

- Auxiliary input jack.
- USB.
- Auxiliary power point.
- My Ford dock.
- Cup holders.

### My Ford Dock (if Equipped)

### WARNING



Driving while distracted can result in loss of vehicle control, crash and injury. We strongly recommend that you use extreme caution when using any device that may take your focus off the road. Your primary responsibility is the safe operation of your vehicle. We recommend against the use of any hand-held device while driving and encourage the use of voice-operated systems when possible. Make sure you are aware of all applicable local laws that may affect the use of electronic devices while driving.

**Note:** Do not leave cell phones or other electronic items which are temperature-sensitive inside the storage compartment for long periods of time. The sun can cause high temperatures inside the storage compartment, which may damage the device. Refer to the device's manual for suitable storage temperatures.



E174985

1. Press the button to fully open the device dock.
2. Place the device on the lower rubber mat.



E174986

3. Press the lid downward until it holds the device.
4. Press and hold the button to release the device.

# Storage Compartments

---

## BOTTLE HOLDER



E174674

## MAP POCKETS

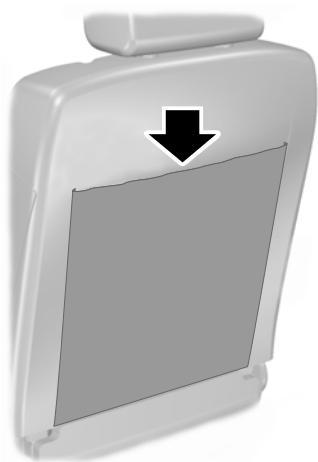

E74686





# Starting and Stopping the Engine

## GENERAL INFORMATION

### WARNINGS

 Extended idling at high engine speeds can produce very high temperatures in the engine and exhaust system, creating the risk of fire or other damage.

 Do not park, idle or drive your vehicle on dry grass or other dry ground cover. The emission system heats up the engine compartment and exhaust system, creating the risk of fire.

 Do not start the engine in a closed garage or in other enclosed areas. Exhaust fumes can be toxic. Always open the garage door before you start the engine.

 If you smell exhaust fumes inside your vehicle, have it checked by a Ford Dealer immediately. Do not drive your vehicle if you smell exhaust fumes.

If the vehicle battery is disconnected, the guidelines are not fully functional directly after the battery is reconnected. The guidelines become fully functional after you drive your vehicle as straight as possible for five minutes at a minimum speed of 10 km/h. You can disregard any unusual driving characteristics during this period.

When you start the engine, avoid pressing the accelerator pedal before and during operation. Only use the accelerator pedal when you have difficulty starting the engine.

## IGNITION SWITCH



E72128

**0** (off) - The ignition is off.

**Note:** When you switch the ignition off and leave your vehicle, do not leave your key in the ignition. This could cause your vehicle battery to lose charge.

**I** (accessory) - Allows the electrical accessories, such as the radio, to operate while the engine is not running.

**Note:** Do not leave the ignition key in this position for too long. This could cause your vehicle battery to lose charge.

**II** (on) - All electrical circuits are operational and the warning lamps and indicators illuminate.

**III** (start) - cranks the engine.

## STEERING WHEEL LOCK

### WARNING

 Always check that the steering is unlocked before attempting to move your vehicle.

To lock the steering wheel:

1. Remove the key from the ignition switch.
2. Rotate the steering wheel slightly to engage the lock.

# Starting and Stopping the Engine

---

To unlock the steering wheel:

1. Insert the key in the ignition switch.
2. Turn the key to position **I**.

**Note:** You may need to rotate the steering wheel slightly to assist unlocking if there is a steering wheel load applied.

## STARTING A GASOLINE ENGINE

**Note:** You can only operate the starter 10 seconds. The number of start attempts is limited to approximately six. If you exceed this limit, the system does not allow you to try again for about 30 minutes.

### Cold or Hot Engine

#### Vehicles with Manual Transmission

**Note:** Do not touch the accelerator pedal.

**Note:** Releasing the clutch pedal while the engine is starting stops the engine cranking and returns the ignition to on.

1. Fully depress the clutch pedal.
2. Start the engine.

#### Vehicles with Automatic Transmission

**Note:** Do not touch the accelerator pedal.

1. Depress the brake pedal.
2. Move the transmission selector lever to position **P** or **N**.
3. Start the engine.

### All Vehicles

If the engine does not start within 10 seconds, wait for a short period and try again.

If the engine does not start after three attempts, wait 10 seconds and follow the flooded engine procedure.

If you have difficulty starting the engine when the temperature is below  $-25^{\circ}\text{C}$ , press the accelerator pedal to the mid-way point of its travel and try again.

## Fuel Flooded Engine

### Vehicles with Manual Transmission

1. Fully depress the clutch pedal.
2. Fully depress the accelerator pedal and hold it there.
3. Start the engine.

### Vehicles with Automatic Transmission

1. Depress the brake pedal.
2. Move the transmission selector lever to position **P** or **N**.
3. Fully depress the accelerator pedal and hold it there.
4. Start the engine.

### All Vehicles

If the engine does not start, repeat the cold or hot engine procedure.

## Engine Idle Speed after Starting

The speed at which the engine idles immediately after starting minimizes vehicle emissions and maximizes cabin comfort and fuel economy.

The idle speed varies depending on certain factors. These include vehicle component and ambient temperatures as well as electrical and climate system demands.

## Failure to Start

### Vehicles with Manual Transmission

If the engine does not crank when you fully depress the clutch pedal with the ignition key in position **III**, follow this procedure:

1. Fully depress the clutch and brake pedals.

# Starting and Stopping the Engine

---

- Turn the key to position **III** until the engine has started.

## STARTING A DIESEL ENGINE

### Cold or Hot Engine

#### All Vehicles

**Note:** When the temperature is below  $-15^{\circ}\text{C}$ , you may need to crank the engine for up to 10 seconds.

**Note:** You can only operate the starter for a limited period of time.

**Note:** After a limited number of attempts to start your engine, the system will not allow you to try again until a period of time has elapsed, for example 30 minutes.



Switch the ignition on and wait until the glow plug indicator goes off.

#### Vehicles With Manual Transmission

**Note:** Do not touch the accelerator pedal.

**Note:** Releasing the clutch pedal while the engine is starting will stop the engine cranking and return to ignition on.

- Fully depress the clutch pedal.
- Start the engine.

#### Vehicles With Automatic Transmission

**Note:** Do not touch the accelerator pedal.

**Note:** Releasing the brake pedal while the engine is starting will stop the engine cranking and return to ignition on.

- Move the transmission selector lever to position **P** or **N**.
- Fully depress the brake pedal.
- Start the engine.

## Failure to Start

### Vehicles With Manual Transmission

If the engine does not crank when the clutch pedal has been fully depressed and the ignition key is turned to position **III**.

- Fully depress the clutch and brake pedals.
- Turn the key to position **III** until the engine has started.

## SWITCHING OFF THE ENGINE

### Vehicles With a Turbocharger

#### WARNING



Do not switch the engine off when it is running at high speed. If you do, the turbocharger will continue running after the engine oil pressure has dropped to zero. This will lead to premature turbocharger bearing wear.

---

Release the accelerator pedal. Wait until the engine has reached idle speed and then switch it off.

# Fuel and Refueling

## SAFETY PRECAUTIONS

### WARNINGS



Do not overfill the fuel tank. The pressure in an overfilled tank may cause leakage and lead to fuel spray and fire.



Automotive fuels can cause serious injury or death if misused or mishandled.



The flow of fuel through a fuel pump nozzle can produce static electricity, which can cause a fire if fuel is pumped into an ungrounded fuel container.



Gasoline may contain benzene, which is a cancer-causing agent.



When refueling always shut the engine off and never allow sparks or open flames near the filler neck.

Never smoke while refueling. Fuel vapor is extremely hazardous under certain conditions. Care should be taken to avoid inhaling excess fumes.



The fuel system may be under pressure. If you hear a hissing sound near the fuel filler door, do not refuel until the sound stops. Otherwise, fuel may spray out, which could cause serious personal injury.

Observe the following guidelines when handling automotive fuel:

- Extinguish all smoking materials and any open flames before refueling your vehicle.
- Always turn off the vehicle before refueling.

- Automotive fuels can be harmful or fatal if swallowed. Fuel such as gasoline is highly toxic and if swallowed can cause death or permanent injury. If fuel is swallowed, call a physician immediately, even if no symptoms are immediately apparent. The toxic effects of fuel may not be visible for hours.
- Avoid inhaling fuel vapors. Inhaling too much fuel vapor of any kind can lead to eye and respiratory tract irritation. In severe cases, excessive or prolonged breathing of fuel vapor can cause serious illness and permanent injury.
- Avoid getting fuel liquid in your eyes. If fuel is splashed in the eyes, remove contact lenses (if worn), flush with water for 15 minutes and seek medical attention. Failure to seek proper medical attention could lead to permanent injury.
- Fuels can also be harmful if absorbed through the skin. If fuel is splashed on the skin, clothing or both, promptly remove contaminated clothing and wash skin thoroughly with soap and water. Repeated or prolonged skin contact with fuel liquid or vapor causes skin irritation.

## FUEL QUALITY - GASOLINE

### WARNINGS



Do not mix gasoline with oil, diesel or other liquids. This could cause a chemical reaction.



Do not use leaded gasoline or gasoline with additives containing other metallic compounds (e.g. manganese-based). They could damage the emission system.

**Note:** We recommend that you use only high quality fuel.

# Fuel and Refueling

**Note:** We do not recommend the use of additional additives or other engine treatments for normal vehicle use.



E207795

Use minimum 91 RON octane unleaded gasoline that meets the specification defined by EN 228 or the equivalent national specification.

Your vehicle is suitable for use with ethanol blends up to 10% (E5 and E10).

## Long-Term Storage

Most gasoline contains ethanol. We recommend that you fill the fuel tank with fuel that does not contain ethanol if you intend to store your vehicle for more than two months. Alternatively, we recommend that you seek advice from an authorized dealer.

## FUEL QUALITY - DIESEL

### WARNINGS



Do not mix diesel with oil, gasoline or other liquids. This could cause a chemical reaction.



Do not add kerosene, paraffin or gasoline to diesel. This could cause damage to the fuel system.

**Note:** We recommend that you use only high quality fuel.

**Note:** We do not recommend the use of additional additives or other engine treatments for normal vehicle use.

**Note:** We do not recommend the use of additional additives to prevent fuel waxing.

## Biodiesel Usage

### WARNING



Do not use raw oils, fats or waste cooking greases, these are not biodiesel.

Your vehicle is suitable for use with biodiesel blends up to 5% (B5). You can achieve acceptable engine performance and durability using B5 by adhering to below guidelines.

**Note:** Use diesel fuel that meets the equivalent specification defined by EN 590 or the relevant national specification, from a trusted fuel supplier

**Note:** If your vehicle experiences low temperature fuel waxing issues, consider using different diesel brands or diesel with lower biodiesel content.

## Long-Term Storage

Most diesel fuels contain biodiesel. Do not leave vehicles filled with B5 fuels parked for more than 1 month. Diesel fuels containing biodiesel can degrade quickly when stored for long periods of time, especially when exposed to warm and humid conditions. It is recommended to fill the tank with purely mineral diesel (where available) or add an anti-oxidant prior to long-term storage of your vehicle exceeding one month. Alternatively, we recommend that you seek advice from your authorized dealer.

## RUNNING OUT OF FUEL

Avoid running out of fuel because this situation may have an adverse effect on engine components.

# Fuel and Refueling

If you have run out of fuel:

- You may need to cycle the ignition from off to on several times after refueling to allow the fuel system to pump the fuel from the tank to the engine. On restarting, cranking time will take a few seconds longer than normal.
- Normally, adding 4 L of fuel is enough to restart the engine. If the vehicle is out of fuel and on a steep grade, more than 4 L may be required.

## CATALYTIC CONVERTER

In order for your vehicle to comply with the legislation of maximum gas emissions limits, it is equipped with a catalytic converter, a device which reduces the pollution of the gases generated by the engine, transforming them to less harmful substances. It is part of the vehicle exhaust system.

### WARNINGS





 Vehicles equipped with catalytic converters should not run in an enclosed area, as the emitted gases are harmful to your health.

 Do not park or idle your vehicle over dry leaves, dry grass or other combustible materials. The exhaust will radiate a considerable amount of heat during use, and after you have switched the engine off. This is a potential fire hazard.

 Exhaust leaks may result in entry of harmful and potentially lethal fumes into the passenger compartment. If you smell exhaust fumes inside your vehicle, have your authorized dealer inspect it immediately. Do not drive if you smell exhaust fumes.



## Driving with a Catalytic Converter

### WARNINGS

-  Avoid running out of fuel.
-  Do not crank the engine for long periods.
-  Do not run the engine when a spark plug lead is disconnected.
-  Do not push-start or tow-start your vehicle. Use booster cables. See **Jump Starting the Vehicle** (page 104).
-  Do not switch the ignition off when driving.

## REFUELING

### WARNINGS

-  Do not attempt to start the engine if you have filled the fuel tank with the incorrect fuel. This could damage the engine. Have the system checked immediately by an authorized dealer.
-  Do not use any kind of flames or heat near the fuel system. The fuel system is under pressure. There is a risk of injury if the fuel system is leaking.
-  If you use a high pressure spray to wash your vehicle, only spray the fuel filler flap briefly from a distance not less than 20 cm.

## Fuel Filler Door

Pull the release lever in the floor to the side of the driver seat to open the fuel tank filler door.

# Fuel and Refueling

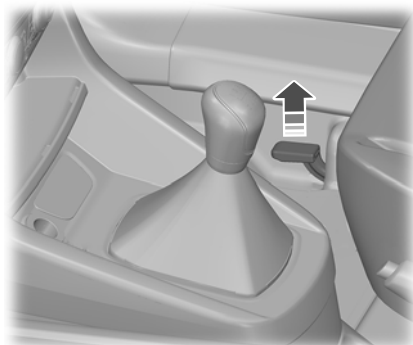

E208603

## Fuel Filler Cap

Your fuel tank filler cap has a regular turn style design, with two to three turns on or off.

When fueling your vehicle:

1. Turn the engine off.
2. Carefully turn the filler cap counterclockwise two to three turns, until it opens.
3. Hang the fuel cap tether cord on the filler door hook.
4. After refueling, to install the cap, align it with the filler pipe.
5. Turn the filler cap clockwise two to three turns until it clicks three times.

If you must replace the fuel filler cap, replace it with a fuel filler cap that is designed for your vehicle. The customer warranty may be void for any damage to the fuel tank or fuel system if the correct genuine Ford fuel filler cap is not used.

## FUEL CONSUMPTION

**Note:** *The amount of fuel in the empty reserve varies and should not be relied upon to increase driving range. When refueling your vehicle after the fuel gauge indicates empty, you might not be able to refuel the full amount of the advertised capacity due to the empty reserve still present in the fuel tank.*

Indicated capacity is the difference in the amount of fuel in the fuel tank and when the fuel gauge indicates empty. Empty reserve is the amount of fuel in the fuel tank after the fuel gauge indicates empty.

Your authorized dealer can give you advice on improving your fuel consumption.

## Filling the Fuel Tank

For consistent results when filling the fuel tank:

- Turn the ignition off before fueling; an inaccurate reading results if the engine is left running.
- Use the same fill rate (low-medium-high) each time the tank is filled.
- The maximum tank capacity, during fueling, is reached when the pump is automatically cut off for the third time.

Results are most accurate when the filling method is consistent.

## Calculating Fuel Economy

Do not measure fuel economy during the first 1,500 km of driving (this is your engine's break-in period); a more accurate measurement is obtained after 3,000 km. Also, fuel expense, frequency of fill ups or fuel gauge readings are not accurate ways to measure fuel economy.

1. Fill the fuel tank completely and record the initial odometer reading.

# Fuel and Refueling

---

2. Fill the fuel tank completely and record the initial odometer reading.
3. Subtract your initial odometer reading from the current odometer reading.
4. Calculate fuel economy by dividing traveled kilometers by liters used.

Record the type of driving (city or highway, winter or summer) to associate it with the Fuel Economy calculated number. In general, driving in city conditions or lower temperatures means lower fuel economy.

This provides an accurate estimate of your vehicle's fuel economy under current driving conditions.

Average fuel economy information is displayed on the cluster. In order to have an accurate value for fuel economy for the type of driving (city or highway), reset the values when you refill the tank. The value displayed on the cluster indicates the average fuel economy since the function was last reset.



# Transmission

## MANUAL TRANSMISSION

### 5-Speed Manual Transmission

#### Using the Clutch

**Note:** Failure to fully press the clutch pedal to the floor may cause increased shift efforts, prematurely wear transmission components or damage the transmission.

**Note:** Do not drive with your foot resting on the clutch pedal or use the clutch pedal to hold your vehicle at a standstill while waiting on a hill. These actions will reduce the life of the clutch.

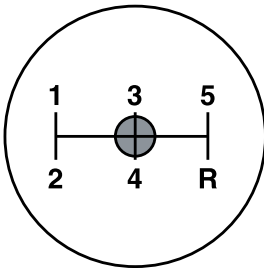

E144905

Manual transmission vehicles have a starter interlock that prevents cranking the engine unless the clutch pedal is fully pressed.

To start the vehicle:

1. Make sure the parking brake is fully set.
2. Press the clutch pedal to the floor, then put the gearshift lever in the neutral position.
3. Start the engine.
4. Press the brake pedal and move the gearshift lever to the desired gear; **1** (First) or **R** (Reverse).
5. Release the parking brake, then slowly release the clutch pedal while slowly pressing on the accelerator.

#### Recommended Shift Speeds

**Note:** Do not downshift into **1** (First) when your vehicle is moving faster than 24 km/h. This will damage the clutch.

**Note:** Upshift following your shift indicator, if fitted to your vehicle.

When driving a vehicle equipped with a manual transmission, do not operate the engine below 1250 RPM while driving with the transmission in any gear. This does not apply while starting or idling the engine while the transmission is in neutral and/or the clutch pedal is pressed. Lugging the engine below 1250 RPM may result in damage to the vehicle engine, poor fuel economy, poor acceleration, and undesirable noise, vibration, and harshness. Choose the next lowest gear until a proper engine RPM is reached.

#### Recommended upshifts (for best fuel economy) when accelerating

Gear selection	Speed range		
	1.2L Ti-VCT	1.5L Ti-VCT	1.5L TDCi
Upshift			
1-2	15 km/h	15 km/h	20 km/h
2-3	25 km/h	25 km/h	30 km/h
3-4	40 km/h	40 km/h	40 km/h
4-5	50 km/h	50 km/h	50 km/h

# Transmission

## Recommended downshifts (for best fuel economy)

Gear selection	Speed range
	1.2L Ti-VCT, 1.5L Ti-VCT & 1.5L TDCi
5-4	50 km/h
4-3	40 km/h
3-2	25 km/h
2-1	15 km/h

## Reverse

**Note:** Make sure that your vehicle is at a complete stop before you shift into **R** (Reverse). Failure to do so may damage the transmission.

**Note:** The gearshift lever can only be moved into **R** (Reverse) by moving it from left of **3** (Third) and **4** (Fourth) before shifting into **R** (Reverse). This is a lockout feature that protects the transmission from accidentally being shifted into **R** (Reverse) from **5** (Fifth).

Hold the clutch pedal down and move the gearshift lever into the neutral position. Shift into **R** (Reverse).

If **R** (Reverse) is not fully engaged, press the clutch pedal down and return the gearshift to the neutral position. Release the clutch pedal for a moment, then press it down and shift to **R** (Reverse) again.

## Parking Your Vehicle

### WARNING



Do not park your vehicle in Neutral, it may move unexpectedly and injure someone. Use **1** (First) gear and set the parking brake fully.

To park your vehicle:

1. Apply the brake and shift into the neutral position.
2. Fully apply the parking brake, hold the clutch pedal down, then shift into **1** (First).
3. Turn the ignition off.

## AUTOMATIC TRANSMISSION

### PowerShift Automatic Transmission

#### WARNINGS



Always set the parking brake fully and make sure the gearshift is latched in **P** (Park). Turn the ignition to the off position and remove the key whenever you leave your vehicle.



Do not apply the brake pedal and accelerator pedal simultaneously. Applying both pedals simultaneously for more than three seconds will limit engine rpm, which may result in difficulty maintaining speed in traffic and could lead to serious injury.

**Note:** Some sound and shift characteristics are unique to the transmission in your vehicle. These operations are normal and do not affect the durability of the transmission.

# Transmission

**Note:** Do not use the accelerator to hold your vehicle at a standstill while waiting on a hill. This will overheat the transmission.

## Putting your vehicle in gear:

1. Fully press down the brake pedal.
2. Press and hold the button on the front of the gearshift lever.
3. Move the gearshift lever into the desired gear.
4. Release the button and your transmission will remain in the selected gear.



E161746

## **P (Park)**

This position locks the transmission and prevents the front wheels from spinning. Come to a complete stop before putting your vehicle into and out of **P** (Park).

## **R (Reverse)**

With the gearshift lever in **R** (Reverse), the vehicle will move backward. Always come to a complete stop before shifting into and out of **R** (Reverse).

## **N (Neutral)**

With the gearshift lever in **N** (Neutral), you have the ability to start your vehicle and it is free to roll. Hold the brake pedal down while in this position.

**Note:** If your vehicle must be towed, use this gearshift lever position.

## **D (Drive)**

The normal driving position for the best fuel economy.

## **S (Sport)**

With the gearshift lever in **S** (Sport), you have the ability to select gears quicker and at higher engine speeds.

Sport mode will remain on until you either shift manually up or down the gears using the **+** or **-** buttons on the side of the gearshift lever or you move the transmission selector lever to **D** (Drive).

## **SelectShift Automatic™ Transmission**

Your SelectShift Automatic transmission allows you the ability to change gears manually.

To use SelectShift, move the gearshift lever into **S** (Sport). Use the **+** or **-** buttons on the side of your gearshift lever to manually change gears.

- Press the **(+)** button to upshift.
- Press the **(-)** button to downshift.

**Note:** After you have assumed manual control with SelectShift, your vehicle will remain in this mode until you return the gearshift lever from **S** (Sport), back to **D** (Drive).

Upshift to the recommended shift speeds according to the following chart:

# Transmission

## Recommended upshift speed when accelerating using SelectShift mode (for optimum fuel economy)

Gear Upshift		km/h
From	To	
1	2	16 km/h
2	3	25 km/h
3	4	33 km/h
4	5	46 km/h
5	6	61 km/h

The instrument cluster will display your currently selected gear.

**Note:** *The transmission will automatically upshift if your engine speed is too high or downshift if your engine speed is too low.*

## Brake-Shift Interlock Override

### WARNINGS



Do not drive your vehicle until you verify that the brake lamps are working.



When doing this procedure, you will be taking your vehicle out of **P** (park), which means your vehicle can roll freely. To avoid unwanted vehicle movement, always fully set the parking brake prior to doing this procedure. Use wheel chocks if appropriate.



If the parking brake is fully released, but the brake warning lamp remains illuminated, the brakes may not be working properly. See your authorized dealer.

Use the brake shift override to move the gearshift lever from the park position in the event of an electrical malfunction or if your vehicle has a dead battery.

Apply the parking brake and turn the ignition off before performing this procedure.

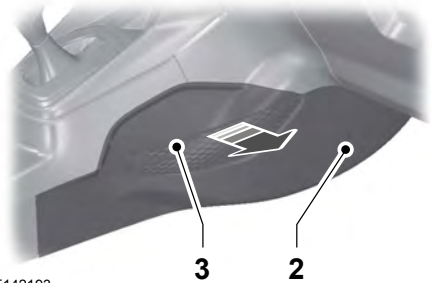

E142193

1. Apply the parking brake and switch the ignition off before carrying out this procedure.
2. Remove the retaining screw.
3. Remove the right side center console side panel.

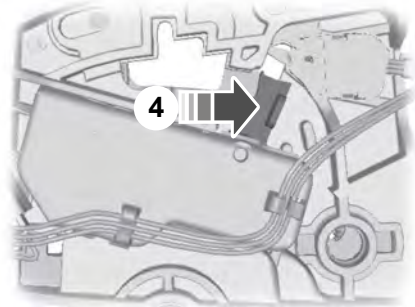

E142214

4. Press the brake pedal. Using a suitable tool rotate the lever forward while pulling the transmission selector lever out of the **P** (park) position and into the **N** (neutral) position.
5. Install the console cover.

# Transmission

---

6. Apply the brake pedal, start your vehicle and release the parking brake.

# Brakes

## GENERAL INFORMATION

### WARNING



The system does not relieve you of your responsibility to drive with due care and attention.

**Note:** Occasional brake noise is normal. If a metal-to-metal, continuous grinding or continuous squeal sound is present, the brake linings may be worn-out. If the vehicle has continuous vibration or shudder in the steering wheel while braking, have your vehicle checked by an authorized dealer.

**Note:** Brake dust may accumulate on the wheels, even under normal driving conditions. Some dust is inevitable as the brakes wear. See **Cleaning the Alloy Wheels** (page 142).

Wet brakes result in reduced braking efficiency. Gently press the brake pedal a few times when driving from a car wash or standing water to dry the brakes.

## Anti-lock Brake System

This system helps you maintain steering control and vehicle stability during emergency stops by keeping the brakes from locking.

## HINTS ON DRIVING WITH ANTI-LOCK BRAKES

**Note:** When the system is operating, the brake pedal may pulse and may travel further. Maintain pressure on the brake pedal. You may also hear a noise from the system. This is normal.

The anti-lock braking system will not eliminate the risks when:

- You drive too closely to the vehicle in front of you.
- Your vehicle is hydroplaning.

- You take corners too fast.
- The road surface is poor.

## PARKING BRAKE

### Vehicles With Automatic Transmission

#### WARNING



Always set the parking brake fully and leave your vehicle with the transmission selector lever in position P.

**Note:** If you park your vehicle on a hill and facing uphill move the transmission selector lever to position P and turn the steering wheel away from the curb.

**Note:** If you park your vehicle on a hill and facing downhill move the transmission selector lever to position P and turn the steering wheel toward the curb.

### Vehicles With Manual Transmission

#### WARNING



Always set the parking brake fully.

**Note:** If you park your vehicle on a hill and facing uphill select first gear and turn the steering wheel away from the curb.

**Note:** If you park your vehicle on a hill and facing downhill select reverse gear and turn the steering wheel toward the curb.

# Brakes

## All Vehicles

### WARNING



If the parking brake is fully released, but the brake warning lamp remains illuminated, the brakes may not be working properly. See your authorized dealer as soon as possible.

**Note:** *Do not press the release button while pulling the lever up.*

To apply the parking brake:

1. Press the foot brake pedal firmly.
2. Pull the parking brake lever up to its fullest extent.

To release the parking brake:

1. Press the brake pedal firmly.
2. Pull the lever up slightly.
3. Press the release button and push the lever down.

## HILL START ASSIST (If Equipped)

### WARNINGS



The system does not replace the parking brake. When you leave your vehicle, always apply the parking brake.



You must remain in your vehicle once you have activated the system.



During all times, you are responsible for controlling your vehicle, supervising the system and intervening, if required.



If the engine is revved excessively, or if a malfunction is detected, the system will be deactivated.

The system makes it easier to pull away when your vehicle is on an uphill slope without the need to use the parking brake.

When the system is active, your vehicle will remain stationary on the uphill slope for two to three seconds after you release the brake pedal. This allows you time to move your foot from the brake to the accelerator pedal. The brakes are released automatically once the engine has developed sufficient drive to prevent your vehicle from rolling down the slope. This is an advantage when pulling away on a slope, (for example from a car park ramp, traffic lights or when reversing uphill into a parking space).

The system will activate automatically on an uphill slope to prevent in vehicle rollback.

## Using Hill Start Assist

1. Press the brake pedal to bring your vehicle to a complete standstill. Keep the brake pedal pressed and vehicle on gear.
2. If the sensors detect that your vehicle is on an uphill slope, the system will be activated automatically.
3. When you remove your foot from the brake pedal, your vehicle will remain on the uphill slope without rolling away for approximately two or three seconds.
4. Drive off in the normal manner. The brakes will be released automatically.

# Traction Control (If Equipped)

---

## PRINCIPLE OF OPERATION

The traction control system helps avoid drive wheel spin and loss of traction.

If your vehicle begins to slide, the system applies the brakes to individual wheels and, when needed, reduces engine power at the same time. If the wheels spin when accelerating on slippery or loose surfaces, the system reduces engine power in order to increase traction.

## USING TRACTION CONTROL

The system automatically turns on each time you switch the ignition on.

**Note:** *In some situations for example if your vehicle is stuck in snow or mud, turning the system off may be beneficial as this allows the wheels to spin with full engine power.*

### Switching the System Off and On Using the Information Display Controls

Your vehicle comes with this feature already enabled. If required, you can switch this feature off using the information display controls. See (page 56).

Stability control will remain on even when you have switched the traction control off.

### Switching the System Off and On Using the Button (If Equipped)

The button is located in the instrument panel.

Press the button. You will see a message in conjunction with an illuminated icon in the display. Press the button again to return the system to normal mode.

Stability control will remain on even when you have switched the traction control off.



# Stability Control (If Equipped)

## PRINCIPLE OF OPERATION

### Electronic Stability Control

#### WARNING



The system does not relieve you of your responsibility to drive with due care and attention. Failure to do so could result in loss of vehicle control, personal injury or death.

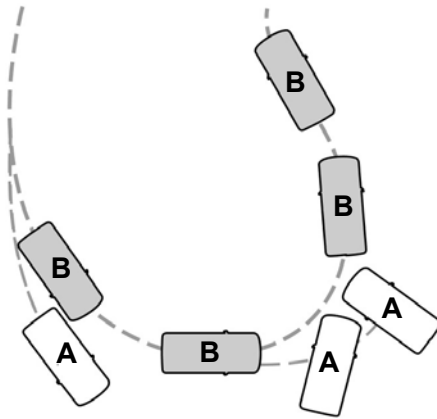

E72903

- A Without ESC
- B With ESC

The system supports stability when your vehicle starts to slide away from your intended path. The system performs this by braking individual wheels and reducing engine torque as required.

The system also provides an enhanced traction control function by reducing engine torque if the wheels spin when you accelerate. This improves your ability to pull away on slippery roads or loose surfaces, and improves comfort by limiting wheel spin in hairpin bends.

### Stability Control Warning Lamp



While driving, it flashes when the system is operating. See **Warning Lamps and Indicators** (page 52).

## USING STABILITY CONTROL

### Switching the System Off and On Using the Information Display Controls

When you switch the ignition on, the system automatically turns on.

You can switch traction control off and on using the vehicle settings menu in the information display. See (page 56).

The system remains off until you switch the ignition off.

**Note:** *Stability control remains on even when you switch the traction control off.*

## STEERING

### Electric Power Steering

#### WARNING



Obtain immediate service if a system error is detected. You may not notice any difference in the feel of your steering, but a serious condition may exist. Failure to do so may result in loss of steering control.

**Note:** *Your vehicle is equipped with an electric power-assisted steering system. There is no fluid reservoir to check or fill.*

The electric power steering system operates by an electric motor, which reduces the effort on the driver's steering wheel.

The system operates progressively and during maneuvers, the system leaves the effort lighter. As the vehicle speed increases, it reduces its action to improve the control of the vehicle.

The electric power steering system has diagnostic checks that continuously monitor the system to ensure proper operation. When a system error occurs, a message will appear in the information display. If this happens, stop the vehicle in a safe place, and switch off the engine. After at least 10 seconds, reset the system by restarting the engine, and watch the information display for a steering message. If a steering message returns, or returns while driving, take the vehicle to an authorized dealer to have it checked.

If your vehicle loses electrical power while you are driving (or if the ignition is turned off), you can steer the vehicle manually, but it takes more effort. Extreme continuous steering may increase the effort it takes for you to steer. This occurs to prevent internal overheating and permanent damage to your steering

system. If this should occur, you will not lose the ability to steer the vehicle manually nor will it cause permanent damage. Typical steering and driving maneuvers will allow the system to cool and steering assist will return to normal.

#### Steering Tips

Avoid sudden movements with the steering wheel. The force required to change the vehicle direction is lower, compared to a vehicle with mechanical steering.

If the steering wanders or pulls, check for:





- An improperly inflated tire
- Uneven tire wear
- Loose or worn suspension components
- Loose or worn steering components
- Improper vehicle alignment

A high crown in the road or high crosswinds may also make the steering seem to wander or pull.

# Load Carrying

## GENERAL INFORMATION

### WARNINGS

-  Do not exceed the maximum front and rear axle loads for your vehicle.
-  Make sure that you secure all loose items properly.
-  Place luggage and other loads as low and as far forward as possible within the luggage or loadspace.
-  Do not drive with the liftgate or rear door open. Exhaust fumes may enter your vehicle.
-  Do not allow items to contact the rear windows.

**Note:** When loading long objects into your vehicle, for example pipes, timber or furniture, be careful not to damage the interior trim.

## LUGGAGE COVERS - 5-DOOR

### WARNING

-  Do not place objects on the luggage cover.

## Removing the Cover

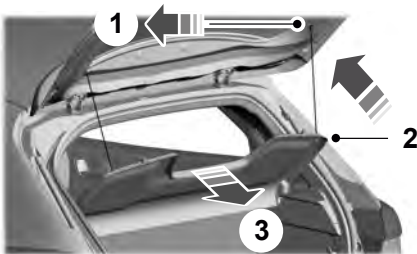

E174649

Install in the reverse order.

# Towing

## TOWING POINTS

### Front Towing Eye

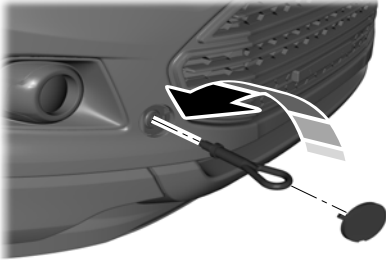

E156610

The towing eye is located in the luggage compartment under the floor cover.

The towing eye must always be carried in the vehicle.

Pry off the cover and install the towing eye.

**Note:** The screw-in towing eye has a left-hand thread. Turn it anti-clockwise to install it. Make sure that the towing eye is fully tightened.

### Rear Towing Hook

**Note:** Use towing rope more than 1.5 m long to avoid interference and damage to the rear bumper.

### 4 door



E208230

The rear towing hook is located on the left side under the rear bumper.

### 5 door

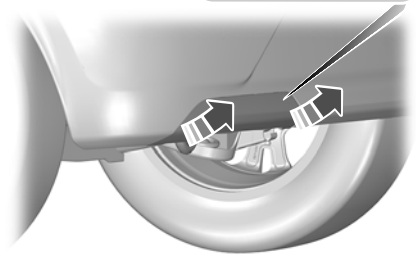
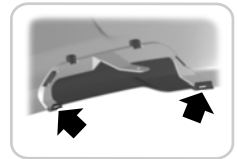

E208227

The rear towing hook is located on the left side under the rear bumper.

# Towing

Carefully remove the tow cover from rear bumper by pulling the clips at both ends to access the hook. This avoids tow rope interference and damage to the rear bumper during towing.

## TOWING THE VEHICLE ON FOUR WHEELS

### All Vehicles

#### WARNINGS



You must switch the ignition on when your vehicle is being towed.



If your vehicle has a steering wheel lock make sure the ignition is in the accessory or on position when being towed.



The brake and steering assistance will not operate unless the engine is running. Press the brake pedal harder and allow for increased stopping distances and heavier steering.



Too much tension in the tow rope could cause damage to your vehicle or the vehicle that is towing.



Do not use a rigid tow bar on the front towing eye.



When towing your vehicle you must select neutral.

Drive off slowly and smoothly without jerking the towed vehicle.

### Vehicles with Automatic Transmission

#### WARNINGS



If a speed of 20 km/h and a distance of 20 km is to be exceeded the vehicle must be towed with a flatbed platform truck.

#### WARNINGS



It is recommended not to tow with the drive wheels on the ground. However, if it is required to move your vehicle from a dangerous location, do not tow your vehicle faster than 20 km/h or further than 20 km.



Do not tow your vehicle backward.



In the event of a mechanical failure of the transmission the drive wheels must be lifted clear of the ground.



Do not tow your vehicle if the ambient temperature is below 0°C.

# Driving Hints

---

## BREAKING-IN

### Tires

#### WARNING



New tires need to be run-in for approximately 500 km. During this time, you may experience different driving characteristics.

---

### Brakes and Clutch

#### WARNING



If possible, avoid hard braking and clutching during the first 150 km in the city, and the first 1,500 km in highways.

---

### Engine

#### WARNING



Avoid driving too fast during the first 1,500 km. Vary your speed frequently and change up through the gears early. Do not labor the engine.

---

## ECONOMICAL DRIVING

Fuel economy is affected by several things such as how you drive, the conditions you drive under and how you maintain your vehicle.

There are some things to keep in mind that may improve your fuel economy:

- Accelerate and slow down in a smooth, moderate fashion.
  - Drive at steady speeds.
  - Anticipate stops; slowing down may eliminate the need to stop.
  - Combine errands and minimize stop-and-go driving.
    - When running errands, go to the furthest destination first and then work your way back home.
  - Close the windows for high-speed driving.
  - Drive at reasonable speeds. (Traveling at 105 km/h uses about 15% less fuel than traveling at 121 km/h).
  - Keep the tires properly inflated and use only the recommended size.
  - Use the recommended engine oil.
  - Perform all regularly scheduled maintenance.
  - Follow the shift indicator on the cluster for ideal timing of gear change. Doing so, increases fuel efficiency and reduces emission. See **Warning Lamps and Indicators** (page 52). for more information about the shift indicator on the cluster.
- There are also some things you may want to avoid doing because they reduce your fuel economy:
- Avoid sudden or hard accelerations.
  - Avoid revving the engine before turning off the vehicle.
  - Avoid long idle periods.
  - Avoid excessive warm up of your vehicle on cold mornings.
  - Reduce the use of air conditioning and heat.
  - Avoid using speed control in hilly terrain.
  - Do not rest your foot on the brake pedal while driving.
  - Avoid carrying unnecessary weight (approximately 1 mpg [0.4 kilometers/liter] is lost for every 180 kg of weight carried).

# Driving Hints

- Avoid adding particular accessories to your vehicle (e.g. bug deflectors, rollbars/light bars, running boards, ski racks).
- Avoid driving with the wheels out of alignment.
- Avoid coasting the vehicle in neutral.
- Avoid following the shift indicator on cluster during uphill driving as it may affect vehicle performance and power while in high gears.



E176360

## COLD WEATHER PRECAUTIONS

The functional operation of some components and systems can be affected at temperatures below  $-10^{\circ}\text{C}$ .

## DRIVING THROUGH WATER

### WARNING



Do not drive through flowing or deep water as you may lose control of your vehicle.

**Note:** *Driving through standing water can cause vehicle damage.*

**Note:** *Engine damage can occur if water enters the air filter.*

Before driving through standing water, check the depth. Never drive through water that is higher than the bottom of the front rocker area of your vehicle.

When driving through standing water, drive very slowly and do not stop your vehicle. Your brake performance and traction may be limited. After driving through water and as soon as it is safe to do so:

- Lightly press the brake pedal to dry the brakes and to check that they work.
- Check that the horn works.
- Check that the exterior lights work.
- Turn the steering wheel to check that the steering power assist works.

## FLOOR MATS

### WARNINGS



Always use floor mats that are designed to fit the foot well of your vehicle. Only use floor mats that leave the pedal area unobstructed. Only use floor mats that are firmly secured to retention posts so that they cannot slip out of position and interfere with the pedals or impair safe operation of your vehicle in other ways.



Pedals that cannot move freely can cause loss of vehicle control and increase the risk of serious personal injury.

# Driving Hints

## WARNINGS



Always make sure that the floor mats are properly attached to the retention posts in the carpet that are supplied with your vehicle. Floor mats must be properly secured to both retention posts to make sure mats do not shift out of position.



Never place floor mats or any other covering in the vehicle foot well that cannot be properly secured to prevent them from moving and interfering with the pedals or the ability to control the vehicle.



Never place floor mats or any other covering on top of already installed floor mats. Floor mats should always rest on top of vehicle carpeting surface and not another floor mat or other covering. Additional floor mats or any other covering will reduce the pedal clearance and potentially interfere with pedal operation.



Check attachment of floor mats on a regular basis. Always properly reinstall and secure floor mats that have been removed for cleaning or replacement.



Always make sure that objects cannot fall into the driver foot well while the vehicle is moving. Objects that are loose can become trapped under the pedals causing a loss of vehicle control.



Failure to properly follow floor mat installation or attachment instructions can potentially cause interference with pedal operation causing a loss of vehicle control.



E142666

To install floor mats, position the floor mat so that the eyelet is over the retention post and press down to lock in.

To remove the floor mat, reverse the installation procedure.



# Roadside Emergencies

## HAZARD WARNING FLASHERS



The hazard warning button is located on the instrument panel.

Use it when your vehicle is creating a safety hazard for other motorists.

Press the button to turn on the hazard warning function, and the front and rear direction indicators will flash.

Press the button again to turn them off.

**Note:** *If used when the engine is not running, the battery will lose charge. There may be insufficient power to restart your engine.*

**Note:** *Depending on applicable laws and regulations in the country for which your vehicle was originally built, the hazard warning flashers may flash if you brake heavily.*

## FIRST AID KIT

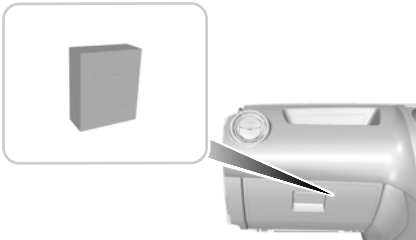

E102206

First aid kit is stored in the glove box. It contains spare fuses, spare bulbs and emergency medical treatment kit. Use it under emergency situations.

## WARNING TRIANGLE

Warning triangle is provided in the luggage compartment.

## FUEL SHUTOFF

### WARNING



Failure to inspect and, if necessary, repair fuel leaks after a collision may increase the risk of fire and serious injury. Ford Motor Company recommends that the fuel system be inspected by an authorized dealer after any collision.

## Vehicles with Airbag

Should your vehicle shut off after a collision, you may restart your vehicle:

1. Switch off the ignition.
2. Switch on the ignition.
3. Repeat Steps 1 and 2 to re-enable the fuel pump.

**Note:** *In the event of severe collision, contact your authorized dealer to restart your vehicle.*

## Vehicles without Airbag

### Location - 4 door

The fuel pump shut-off switch is located behind an access panel on the right side of the luggage compartment. The fuel pump shut-off switch has a red reset button on top of it.

### Location - 5 door

The fuel pump shut-off switch is located behind an access panel in the right rear quarter trim panel, near the liftgate. The fuel pump shut-off switch has a red reset button on top of it.

# Roadside Emergencies

## Resetting the Fuel Pump Shutoff Switch

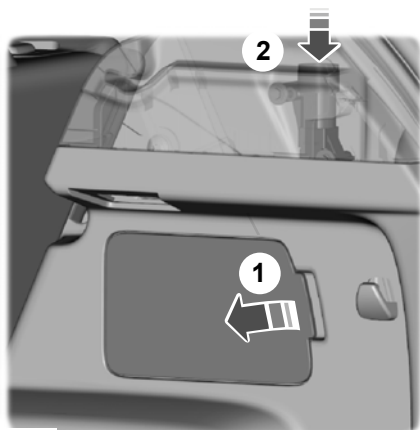

E206175



In the event of a moderate to severe collision, your vehicle is equipped with a fuel pump shut-off feature that stops the flow of fuel to the engine. Not every impact will cause a shut-off.

Should your vehicle shut off after a collision, you may restart your vehicle by doing the following:

1. Turn the ignition off.
2. Check the fuel system for leaks.
3. If no leak is apparent, reset the fuel pump shut-off switch by opening the access panel and pushing in on the reset button.
4. Turn the ignition to the **on** position. Pause for a few seconds and return the ignition to the **off** position.
5. Make a further check for leaks in the fuel system.
6. If no leaks are apparent, restart your vehicle.

## JUMP STARTING THE VEHICLE

### WARNINGS

-  The gases around the battery can explode if exposed to flames, sparks, or lit cigarettes. An explosion could result in injury or vehicle damage.
-  Batteries contain sulfuric acid which can burn skin, eyes and clothing, if contacted.

Do not attempt to push-start your automatic transmission vehicle. Automatic transmissions do not have push-start capability. Attempting to push-start a vehicle with an automatic transmission may cause transmission damage.

### Preparing Your Vehicle

**Note:** Use only a 12-volt supply to start your vehicle.

**Note:** Do not disconnect the battery of the disabled vehicle as this could damage the vehicle's electrical system.

1. Park the booster vehicle close to the hood of the disabled vehicle making sure the two vehicles do not touch. Set the parking brake on both vehicles and stay clear of the engine cooling fan and other moving parts.
2. Check all battery terminals and remove any excessive corrosion before you attach the battery cables. Ensure that vent caps are tight and level.
3. Turn the heater fan on in both vehicles to protect from any electrical surges. Turn all other accessories off.

### Connecting the Jumper Cables

**Note:** In the illustration, the vehicle on the bottom is used to designate the assisting (boosting) battery.

# Roadside Emergencies

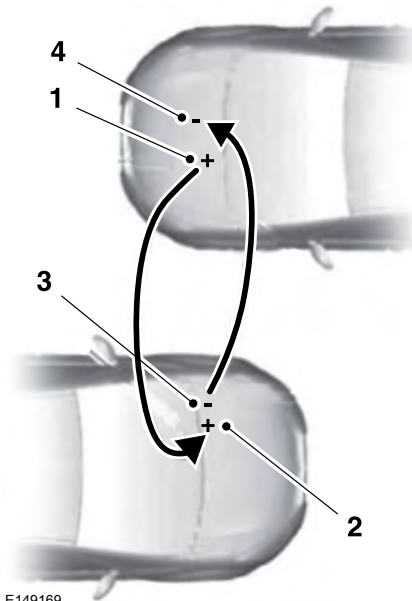

E149169

1. Connect the positive (+) jumper cable to the positive (+) terminal of the discharged battery.
2. Connect the other end of the positive (+) cable to the positive (+) terminal of the assisting battery.
3. Connect the negative (-) cable to the negative (-) terminal of the assisting battery.
4. Make the final connection of the negative (-) cable to an exposed metal part of the stalled vehicle's engine, away from the battery and the carburetor or fuel injection system.

**Note:** Do not attach the negative (-) cable to fuel lines, engine rocker covers, the intake manifold or electrical components as grounding points.

## WARNING



Do not connect the end of the second cable to the negative (-) terminal of the battery to be jumped. A spark may cause an explosion of the gases that surround the battery.

Ensure that the cables are clear of fan blades, belts, moving parts of both engines, or any fuel delivery system parts.

## Jump Starting

1. Start the engine of the booster vehicle and run the engine at moderately increased speed.
2. Start the engine of the disabled vehicle.

**Note:** For vehicles with a manual transmission, if the battery goes flat or you install a new battery, the engine will not start until you press and hold the clutch pedal down for two seconds then release the clutch pedal and wait two seconds with the key turned to the on position and the engine is off.

3. Once the disabled vehicle has been started, run both engines for an additional three minutes before disconnecting the jumper cables.

## Removing the Jumper Cables

Remove the jumper cables in the reverse order that they were connected.

**Note:** In the illustration, the vehicle on the bottom is used to designate the assisting (boosting) battery.

# Roadside Emergencies

## POST-CRASH ALERT SYSTEM

The system flashes the direction indicator lamps in the event of a serious impact that deploys an airbag (front, side, side curtain or Safety Canopy) or the safety belt pretensioners.

The lamps turn off when:

- You press the hazard control button.
- Your vehicle runs out of power.
- You press the unlock button in the remote control.

## TRANSPORTING THE VEHICLE

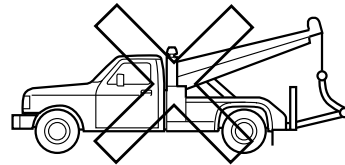
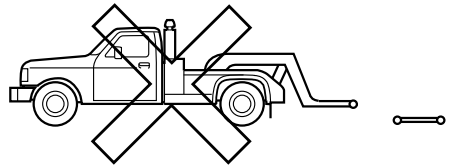
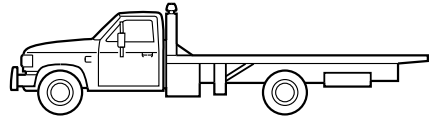

E207867

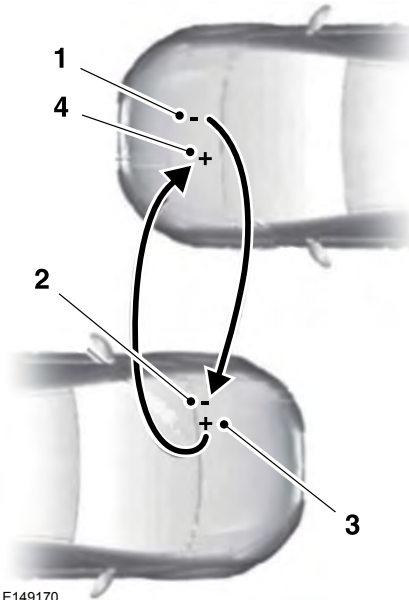

E149170

1. Remove the jumper cable from the ground metal surface.
2. Remove the jumper cable on the negative (-) terminal of the booster vehicle's battery.
3. Remove the jumper cable from the positive (+) terminal of the booster vehicle's battery.
4. Remove the jumper cable from the positive (+) terminal of the disabled vehicle's battery.

After the disabled vehicle has been started and the jumper cables removed, allow it to idle for several minutes so the engine computer can relearn its idle conditions.

# Roadside Emergencies

---

If you need to have your vehicle towed, contact a professional towing service or, if you are a member of a roadside assistance program, your roadside assistance service provider.

It is recommended that your vehicle be towed with a flatbed equipment only. Do not tow with a slingbelt or wheel lift equipment truck. Ford Motor Company has not approved a slingbelt towing procedure. If the vehicle is towed incorrectly, or by any other means, vehicle damage may occur.

You can tow your vehicle with flatbed platform equipment. In case the vehicle is damaged and cannot be driven to the platform by itself, we recommend that you shift the transmission to neutral prior towing to prevent damage to the transmission.

**Note:** *Always contact a professional towing service to tow your vehicle.*

# Fuses

## FUSE BOX LOCATIONS

### Engine Compartment Fuse Box

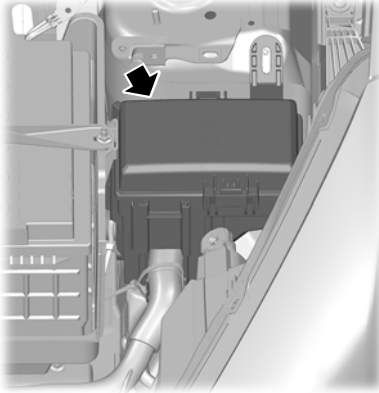

E208374

This fuse box is located in the engine compartment.

### Passenger Compartment Fuse Box

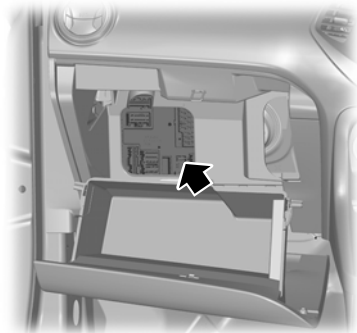

E208375

This fuse box is located behind the glove box. To access the fuse box, do the following:

1. Open the glove box and empty the contents.
2. Press the sides inward and swivel the glove compartment downward.

**Note:** Any improper modification to the electrical system can compromise the safety of the vehicle, implying risk of fire or engine damage. For any clarifications or questions, contact an authorized dealer.

### Battery Fuse Box



E146270

This fuse box is attached to the battery positive terminal.

## FUSE SPECIFICATION CHART - GASOLINE

Your vehicle may not be equipped with all of the features listed in the fusing tables. This information describes all fusing for all available vehicle models.

# Fuses

## Engine Compartment Fuse Box

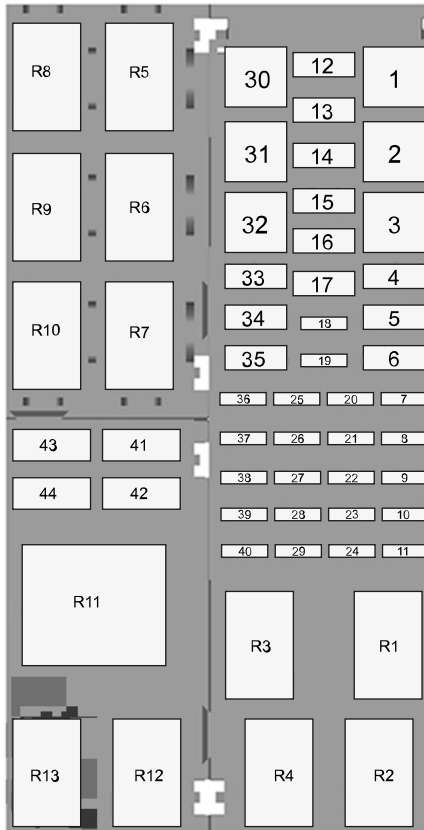

E208369

# Fuses

<b>Fuse</b>	<b>Fuse amp rating</b>	<b>Protected components</b>
1	40A	Blower motor.
2	50A	Electric power assist steering.
3	40A	Automatic transmission module(1.5L AT).
4	30A	Heated backlite.
5	30A	Starter relay.
6	20A	Cigar lighter.
7	-	Not used.
8	5A	Power control module relay coil. Fuel pump relay coil. Ignition relay coil. Transmission control module keep alive power (1.5L AT).
9	10A	AC compressor.
10	-	Not used.
11	-	Not used.
12	-	Not used.
13	-	Not used.
14	-	Not used.
15	-	Not used.
16	-	Not used.
17	-	Not used.
18	10A	Horn (Horn switch).
19	5A	Starter relay coil.
20	20A	Powertrain control module.
21	20A	HEGO sensor. CMS sensor. Purge valve. Variable camshaft timing.
22	5A	A/C relay coil. Cooling fan relay coil.



## Fuses

<b>Fuse</b>	<b>Fuse amp rating</b>	<b>Protected components</b>
23	15A	Ignition coil.
24	5A	Vehicle speed sensor (without ABS).
25	5A	Wiper relay coil.
26	5A	Heated backlite relay coil.
27	10A	Anti-lock brake system module. Headlamp leveller.
28	10A	Powertrain control module. Transmission control module (1.5L AT).
29	-	Not used.
30	50A	Cooling fan high(dual speed).
31	40A	Anti-lock brake system.
32	40A	Cooling fan(single speed)
	30A	Cooling fan low(dual speed)
33	-	Not used.
34	-	Not used.
35	-	Not used.
36	-	Not used.
37	20A	Fuel pump. Fuel injectors.
38	20A	Electronic stability control module (1.5L AT).
39	10A	Brake switch.
40	20A	Horn relays.
41	20A	Front wiper motor.
42	15A	Rear wiper motor.
43	15A	Horn (Body control module).
44	-	Not used.

# Fuses

---

<b>Relay</b>	<b>Circuits switched</b>
R1	Powertrain control module and loads.
R2	Wiper.
R3	Ignition loads.
R4	Horn (Horn switch).
R5	Starter motor.
R6	AC compressor.
R7	Heated backlite.
R8	Cooling fan high (dual speed).
R9	Horn (Body control module).
R10	Cooling fan.
R11	Not used.
R12	Blower motor.
R13	Fuel pump.

# Fuses

## Passenger Compartment Fuse Box

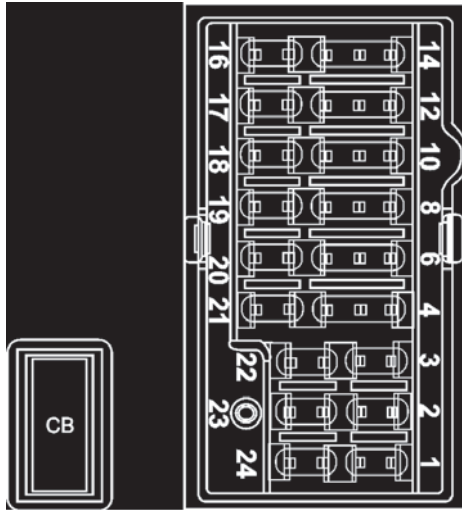

E174652

Fuse	Fuse amp rating	Protected components
1	10A	Audio unit (without SYNC).
2	30A	Not used.
3	20A	Not used.
4	7.5A	Power windows logic (one touch up/down). Power mirrors.
6	10A	Climate control module. SYNC module. Multi function display. Integrated control panel. GPS module. USB charger(without SYNC).
8	7.5A	Instrument cluster. Datalink. Gateway module (with SYNC).
10	5A	Climate control module (without A/C). In-car temperature sensor (with EATC).

## Fuses

Fuse	Fuse amp rating	Protected components
		Electric power assist steering.
12	10A	Airbag control module. Windshield washer pump.
14	-	Not used.
16	30A	Body control module ignition relay
17	20A	Radio supply battery.
18	10A	Datalink. Gateway module (with SYNC).
19	10A	Ignition switch.
20	-	Not used.
21	10A	Not used.
22	10A	Radio (without Power door lock).
23	20A	Power door locks relay.
24	25A	Not used.
CB01	30A	Power windows.

# Fuses

## Battery Fuse Box

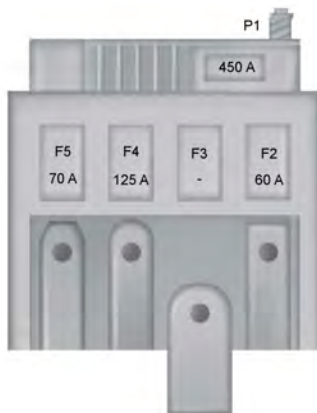

E174653

Fuse	Fuse amp rating	Protected components
1	450A	Starter motor. Alternator.
2	60A	Not used.
3	—	Engine junction box.
4	125A	Body control module.
5	70A	Not used.

## FUSE SPECIFICATION CHART - DIESEL

Your vehicle may not be equipped with all of the features listed in the fusing tables. This information describes all fusing for all available vehicle models.

# Fuses

## Engine Compartment Fuse Box

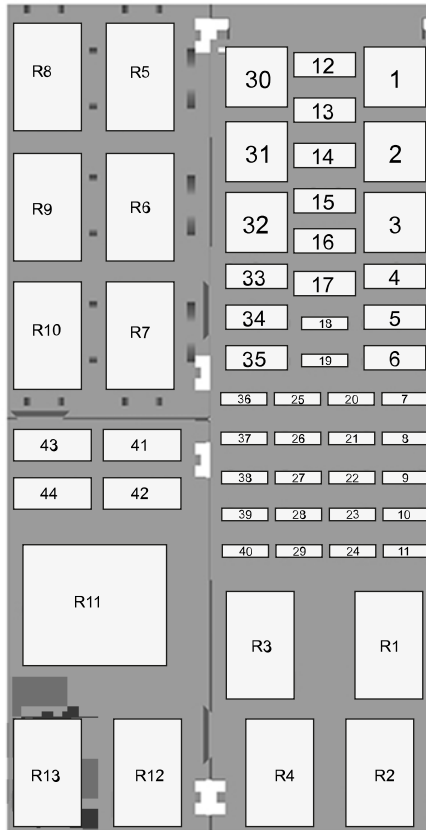

E208369

# Fuses

<b>Fuse</b>	<b>Fuse amp rating</b>	<b>Protected components</b>
1	40A	Blower motor.
2	50A	Electric power assist steering.
3	60A	Glow plugs.
4	30A	Heated backlite.
5	30A	Starter relay.
6	20A	Cigar lighter.
7	-	Not used.
8	5A	Power control module relay coil. Ignition relay coil.
9	10A	AC compressor.
10	-	Not used.
11	-	Not used.
12	-	Not used.
13	-	Not used.
14	-	Not used.
15	-	Not used.
16	-	Not used.
17	-	Not used.
18	10A	Horn (Horn switch)
19	5A	Starter relay coil.
20	20A	Powertrain control module.
21	15A	EGR bypass valve. Wastegate control valve. Fuel metering unit.
22	5A	A/C relay coil. Cooling fan relay coil.
23	5A	TMAF sensor.
24	5A	Vehicle speed sensor (without ABS).

# Fuses

<b>Fuse</b>	<b>Fuse amp rating</b>	<b>Protected components</b>
		Glow plugs relay coil.
25	5A	Fuel shut off switch (without airbag). Wiper relay coil.
26	5A	Heated backlite relay coil. Fuel heater relay coil.
27	10A	Anti-lock brake system module. Headlamp leveller.
28	10A	Powertrain control module.
29	-	Not used.
30	-	Not used.
31	40A	Anti-lock brake system.
32	40A	Cooling fan.
33	-	Not used.
34	-	Not used.
35	-	Not used.
36	-	Not used.
37	20A	Fuel heater.
38	-	Not used.
39	10A	Brake switch.
40	20A	Horn relays.
41	20A	Front wiper motor.
42	15A	Rear wiper motor.
43	15A	Horn (Body control module).
44	-	Not used.



# Fuses

---

<b>Relay</b>	<b>Circuits switched</b>
R1	Powertrain control module and loads.
R2	Wiper.
R3	Ignition loads.
R4	Horn (Horn switch).
R5	Starter motor.
R6	AC compressor.
R7	Heated backlite.
R8	Not used.
R9	Horn (Body control module).
R10	Cooling fan.
R11	Glow plugs.
R12	Blower motor.
R13	Fuel heater.

# Fuses

## Passenger Compartment Fuse Box

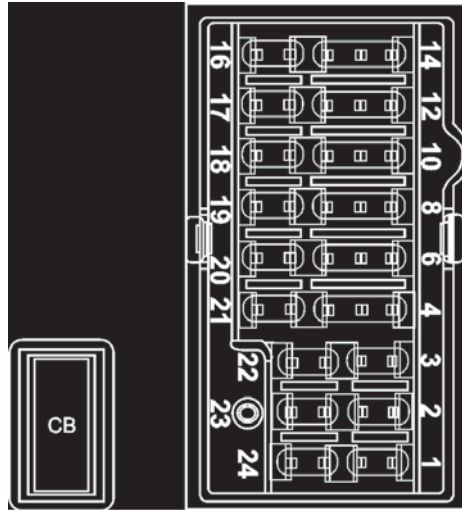

E174652

Fuse	Fuse amp rating	Protected components
1	10A	Audio unit (without SYNC).
2	30A	Not used.
3	20A	Not used.
4	7.5A	Power windows logic (one touch up/down). Power mirrors.
6	10A	Climate control module. SYNC module. Multi function display. Integrated control panel. GPS module. USB charger(without SYNC).
8	7.5A	Instrument cluster. Gateway module (with SYNC).
10	5A	Climate control module without A/C. In-car temperature sensor (with EATC). Electric power assist steering.

# Fuses

Fuse	Fuse amp rating	Protected components
12	10A	Airbag control module. Windshield washer pump.
14	-	Not used.
16	30A	Body control module ignition relay.
17	20A	Radio supply battery.
18	10A	Datalink. Gateway module (with SYNC).
19	10A	Ignition switch.
20	-	Not used.
21	10A	Not used.
22	10A	Radio (without Power door lock).
23	20A	Power door locks relay.
24	25A	Not used.
CB01	30A	Power windows.

## Battery Fuse Box



E174653

# Fuses

Fuse	Fuse amp rating	Protected components
1	450A	Starter motor. Alternator.
2	60A	Not used.
3	-	Engine junction box.
4	125A	Body control module.
5	70A	Not used.

## CHANGING A FUSE

### WARNINGS

 Do not modify the electrical system of your vehicle in any way. Have repairs to the electrical system and the replacement of relays and high current fuses carried out by an authorized dealer.

 Switch the ignition and all electrical equipment off before attempting to change a fuse.

 Always replace a fuse with one that has the specified amperage rating. Using a fuse with a higher amperage rating can cause severe wire damage and could start a fire.

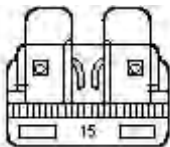

E142430

If electrical components in your vehicle are not working, a fuse may have blown. A break in the fuse wire will indicate a blown fuse. Check the appropriate fuses before replacing any electrical components.

# Maintenance

## GENERAL INFORMATION

Have your vehicle serviced regularly to help maintain its roadworthiness. There is a large network of authorized dealers that are there to help you with their professional servicing expertise. We believe that their specially trained technicians are best qualified to service your vehicle properly and expertly, with a wide range of highly specialized tools.

In addition to regular servicing, we recommend that you carry out the following checks.

### WARNINGS



Switch the ignition off before touching or attempting adjustment of any kind.



Do not touch the electronic ignition system parts after you have switched the ignition on or when the engine is running. The system operates at high voltage.



Keep your hands and clothing clear of the engine cooling fan. Under certain conditions, the fan may continue to run for several minutes after you have switched the engine off.



Make sure that you fit filler caps securely after carrying out maintenance checks.

## Daily Checks

- Exterior lamps.
- Interior lamps.
- Warning lamps and indicators.

## Check When Refueling

- Engine oil level. See **Engine Oil Check** (page 127).
- Brake fluid level. See **Brake Fluid Check** (page 129).

- Washer fluid level. See **Washer Fluid Check** (page 130).
- Tire pressures (when cold). See **Tire Pressures** (page 152).
- Tire condition. See **Wheels and Tires** (page 145).

## Monthly Checks

- Engine coolant level (engine cold). See **Engine Coolant Check** (page 128).
- Pipes, hoses and reservoirs for leaks.
- Air conditioning operation.
- Parking brake operation.
- Horn operation.
- Tightness of lug nuts. See **Tire Pressures** (page 152).

## OPENING AND CLOSING THE HOOD

### Opening the Hood

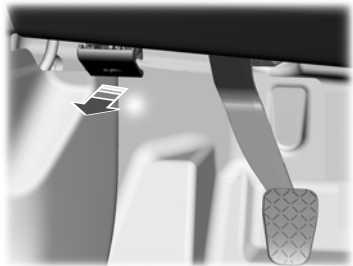

E174767

1. Pull the hood release handle.

# Maintenance



E174768

2. Move the catch to the right.



E87786

3. Open the hood and support it with the hood strut.

## Closing the Hood

1. Remove the hood strut from the catch and secure correctly after use.
2. Lower the hood and allow it to drop from under its own weight for the last 20–30 cm.

**Note:** *Make sure that you have closed the hood correctly.*

# Maintenance

## UNDER HOOD OVERVIEW - 1.2L TIVCT/1.5L TIVCT

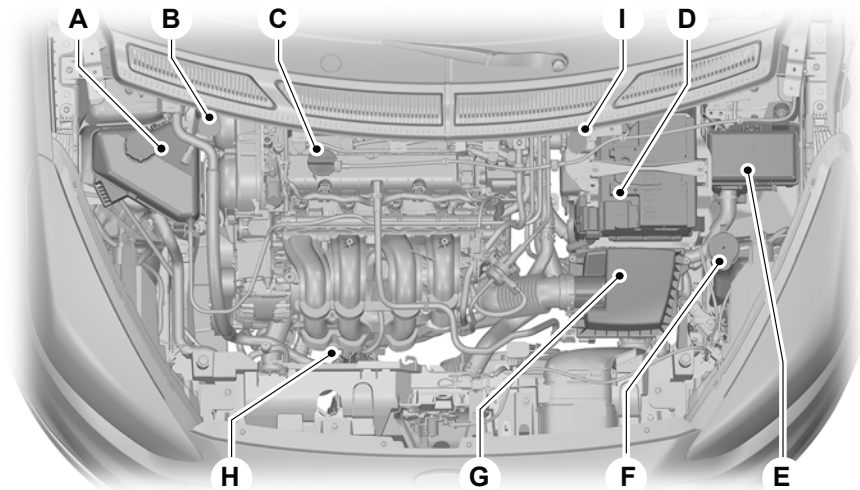

E203908

- A Engine coolant reservoir\*: See **Engine Coolant Check** (page 128).
- B Brake and clutch fluid reservoir - RHD (right-hand drive): See **Brake Fluid Check** (page 129).
- C Engine oil filler cap\*: See **Engine Oil Check** (page 127).
- D Battery: See **Changing the 12V Battery** (page 131).
- E Engine compartment fuse box: See **Fuses** (page 108).
- F Windshield and rear window washer fluid reservoir: See **Washer Fluid Check** (page 130).
- G Air cleaner: See **Changing the Engine Air Filter** (page 140).
- H Engine oil dipstick\*: See **Engine Oil Check** (page 127).
- I Brake and clutch fluid reservoir -LHD (left-hand drive): See **Brake Fluid Check** (page 129).

\* The filler caps and the engine oil dipstick are colored for easy identification.

# Maintenance

## UNDER HOOD OVERVIEW - 1.5L TDCI

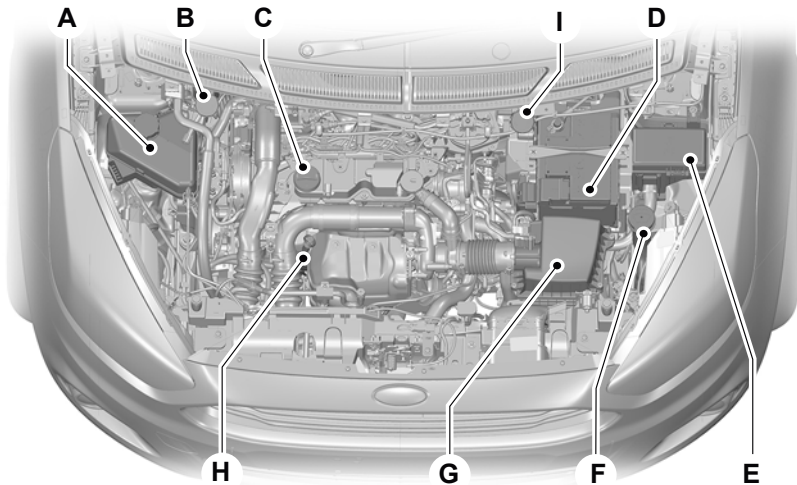

E203844

- A Engine coolant reservoir\*: See **Engine Coolant Check** (page 128).
- B Brake and clutch fluid reservoir - RHD: See **Brake Fluid Check** (page 129).
- C Engine oil filler cap\*: See **Engine Oil Check** (page 127).
- D Battery: See **Changing the 12V Battery** (page 131).
- E Engine compartment fuse box: See **Fuses** (page 108).
- F Windshield and rear window washer fluid reservoir: See **Washer Fluid Check** (page 130).
- G Air cleaner: See **Changing the Engine Air Filter** (page 140).
- H Engine oil dipstick\*: See **Engine Oil Check** (page 127).
- I Brake and clutch fluid reservoir -LHD: See **Brake Fluid Check** (page 129).

\* The filler caps and the engine oil dipstick are colored for easy identification.



# Maintenance

## ENGINE OIL DIPSTICK - 1.2L TIVCT/1.5L TIVCT

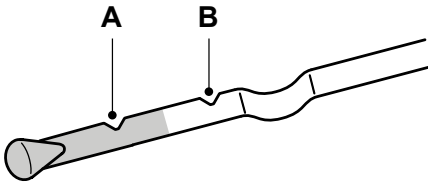

E95540

- A Minimum
- B Maximum

## ENGINE OIL DIPSTICK - 1.5L TDCI

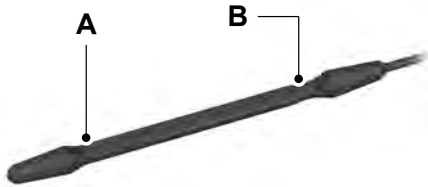

E140423



- A Minimum
- B Maximum

## ENGINE OIL CHECK

### WARNINGS

 Do not use oil additives or other engine treatments. Under certain conditions, they could damage the engine and it is not covered under warranty.

### WARNINGS

-  Empty engine oil containers should not be disposed of in domestic trash bins. Use only proper containers to dispose of this type of waste.
-  When changing your oil, ensure that the oil used is the same as specified and the correct amount. Do not use unknown types of oil or from already opened containers.

**Note:** *The oil consumption of new engines reaches its normal level after approximately 5,000 km.*

### Checking the Oil Level

**Note:** *Check the level before starting the engine.*

**Note:** *Make sure that the level is between the MIN and the MAX marks.*



**Note:** *Level measurement will not be accurate if this procedure is not followed.*

1. Make sure that your vehicle is on level ground.
2. If the engine is running turn it off and wait 15 minutes for the oil to drain into the oil pan.
3. Remove the dipstick and wipe it with a clean, lint free cloth. Replace the dipstick and remove it again to check the oil level.

If the level is at the MIN mark, top up immediately.

### Topping Up

### WARNINGS

-  Only top up when the engine is cold. If the engine is hot, wait 15 minutes for the engine to cool down.
-  Do not remove the filler cap when the engine is running.

# Maintenance

Remove the filler cap.

## WARNING



Do not top up further than the MAX mark.

**Note:** *Oil expands when it is hot. Checking the oil level when hot will be above the MAX mark.*

**Note:** *Soak up any spillage with an absorbent cloth immediately.*

Top up with fluid that meets the Ford specification. See **Capacities and Specifications** (page 162).

Replace the filler cap. Turn it until you feel a strong resistance.

## Engine severe usage conditions

In case of vehicle severe usage, engine oil should be changed every 5,000 km or 3 months, whichever occurs first.

Severe usage conditions:

- Frequent usage of vehicle in short distances (less than 5 km), in which the engine does not reach normal operating temperature,
- Frequent usage of vehicle on dusty roads or in mountain areas,
- Usage in heavy urban traffic,
- Usage as driving instructors vehicle, taxi vehicle, ambulance, military usage or similar activities,
- Extended usage with contaminated fuel.

## Oil Consumption

In the first 5,000 km (run-in period) the oil consumption is higher, and therefore the oil level should be checked more frequently. Maximum acceptable consumption in this period is one liter. After the break-in period the engine can consume up to one liter every 10,000 km. If the consumption is higher, go to your Ford Dealer.

Oil consumption also depends on driving style and vehicle use. Special operating conditions such as, operating your vehicle frequently at high speeds, could increase oil consumption.

## Oil Filter

The oil filter's function is to filter out harmful particles without obstructing the flow of oil to vital parts. Use of oil filters not meeting Ford specifications could damage the engine.

## ENGINE COOLANT CHECK

### WARNING



Do not allow the fluid to touch your skin or eyes. If this happens, rinse the affected areas immediately with plenty of water and contact your physician.

**Note:** *Make sure that the level is between the MIN and the MAX marks.*

**Note:** *Coolant expands when it is hot. The level may therefore extend beyond the MAX mark.*

If the level is at the MIN mark, add coolant immediately.

# Maintenance

## Adding Engine Coolant

### WARNINGS



Only add coolant when the engine is cold. If the engine is hot, wait 10 minutes for the engine to cool down.



Do not remove the filler cap when the engine is running.



Do not remove the filler cap when the engine is hot. Wait for the engine to cool down.



Undiluted coolant is flammable and may ignite if spilt on a hot exhaust.

**Note:** *Inspect or replace the lid with the vehicle turned off and the engine cold, to avoid injuries or burns.*

**Note:** *In an emergency, you can add just water to the cooling system to reach a vehicle service station. Have the system checked by an authorized dealer as soon as possible.*

**Note:** *Prolonged use of incorrect dilution of the coolant can cause engine damage from corrosion, overheating or freezing.*

**Note:** *Do not add coolant further than the MAX mark.*

**Note:** *If coolant levels are outside the standard operational range, the performance of the system may be compromised; seek an authorized dealer immediately.*

**Note:** *The cooling system expansion reservoir lid should be inspected and cleaned every 3 years approximately. If there are any evidences of deterioration of the sealing ring, the lid should be replaced.*

**Note:** *It is normal to see some air bubbles in the coolant reservoir fluid.*

1. Remove the filler cap. Any pressure will escape slowly as you unscrew the cap.

2. Add a mixture of 50% coolant and 50% water using fluid that meets the Ford specifications. See **Capacities and Specifications** (page 162).
3. Replace the filler cap. Turn it clockwise until you feel a strong resistance and it clicks.

## BRAKE FLUID CHECK

### WARNINGS



Do not use any fluid other than the recommended brake fluid as this will reduce brake efficiency. Use of incorrect fluid could result in the loss of vehicle control, serious personal injury or death.



Only use brake fluid from a sealed container. Contamination with dirt, water, petroleum products or other materials may result in brake system damage or failure. Failure to adhere to this warning could result in the loss of vehicle control, serious personal injury or death.



Do not allow the fluid to touch your skin or eyes. If this happens, rinse the affected areas immediately with plenty of water and contact your physician.



A fluid level between the **MAX** and **MIN** lines is within the normal operating range and there is no need to add fluid. A fluid level not in the normal operating range could compromise the performance of the system. Have your vehicle checked immediately.

# Maintenance



E170684

To avoid fluid contamination, the reservoir cap must remain in place and fully tight, unless you are adding fluid.

Only use fluid that meets Ford specifications. See **Capacities and Specifications** (page 153).

## DRAINING THE FUEL FILTER WATER TRAP

### WARNING



Do not dispose of fuel in the household refuse or the public sewage system. Use an authorized waste disposal facility.

**Note:** Only add fuel that meets the Ford specification. See **Fuel Quality** (page 82).

**Note:** The in-tank pump will turn off automatically after approximately 40 seconds.

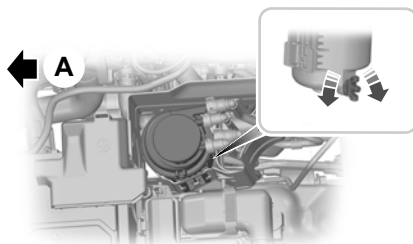

E208053

A Front of Vehicle.

1. Switch the ignition off.
2. Place a suitable container under the drain hose to collect the content before disposal.

**Note:** To drain the fuel filter water trap, access the underside of your vehicle.

3. Loosen the drain plug approximately 1.5 turns.
4. Switch the ignition on to activate the in-tank pump.
5. Allow the water to drain.
6. Switch the ignition off.
7. Tighten the drain plug until you feel a strong resistance.
8. Start the engine.
9. Check for leaks.

**Note:** The water-in-fuel indicator lamp will go out after approximately 2 seconds, with the engine running.

## WASHER FLUID CHECK

**Note:** The reservoir supplies the front and rear washer systems.

# Maintenance

When adding fluid, use a mixture of washer fluid and water to help prevent freezing in cold weather and improve the cleaning capability. We recommend that you use only high quality washer fluid.

For information on fluid dilution, refer to the product instructions.

## CHANGING THE 12V BATTERY

### WARNING



You must replace the battery with one of exactly the same specification.

The battery is located in the engine compartment.

To remove and install the battery:

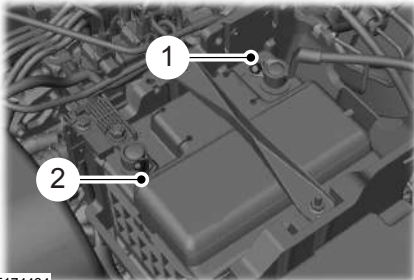

E174484

1. Loosen the nuts from the terminals. Remove the negative battery cable first (1), then the positive battery cable (2).

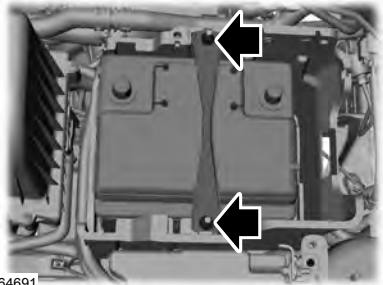

E164691

2. Remove the two nuts from the clamp.
3. Remove the battery.
4. Install in the reverse order.

**Note:** *The acid solution and lead contained in the battery, if discarded improperly in nature, can contaminate soil, subsoil and water, as well as cause damage to human health.*

## CHECKING THE WIPER BLADES

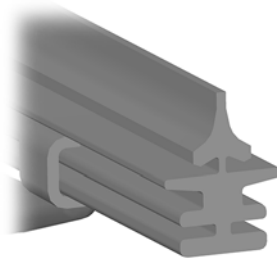

E203709

Run the tip of your fingers over the edge of the blade to check for roughness.

# Maintenance

Clean the wiper blades with washer fluid or water applied with a soft sponge or cloth.

## CHANGING THE WIPER BLADES

### Changing the Windshield Wiper Blades

**Note:** The windshield wiper blades are different in length. If you install wiper blades of the wrong length, the rain sensor may not work correctly.

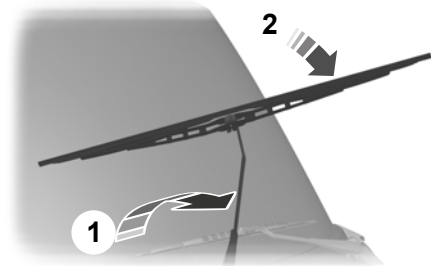

E93783

1. Lift the wiper arm.
2. Position the wiper blade at right angles to the wiper arm.

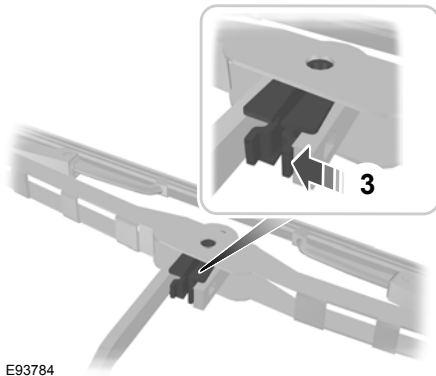

E93784

3. Press the locking lever.

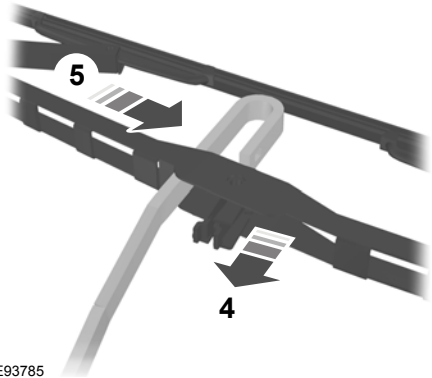

E93785

4. Disengage the wiper blade from the wiper arm.
5. Slide the wiper blade to the side.

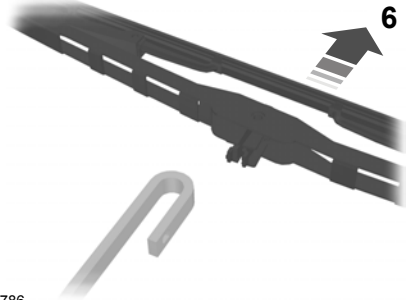

E93786

6. Remove the wiper blade.
7. Install in the reverse order. Make sure that the wiper blade locks into place.

### Changing the Rear Window Wiper Blade

1. Lift the wiper arms to the maximum extent and hold it.

# Maintenance

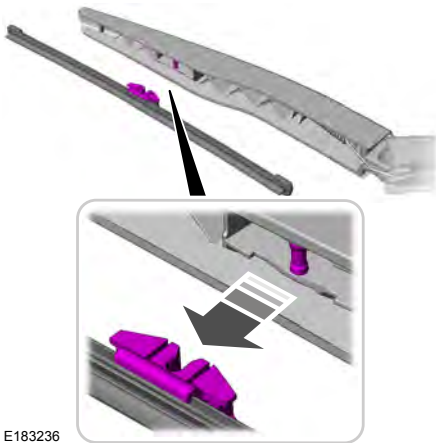

E183236

2. Pull the wiper blade away from the wiper arm.
3. Install the new wiper by aligning with the wiper arm groove and clip them together.

**Note:** Make sure that the wiper blade locks into place.

## REMOVING A HEADLAMP

1. Open the hood. See **Opening and Closing the Hood** (page 123).

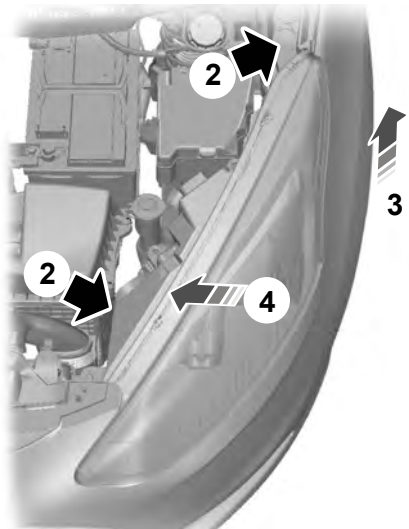

E144433

2. Remove the screws and push pins.
3. Lift the outer side of the headlamp to disengage it from the lower fixing point.
4. Pull the headlamp as far as possible toward the center of your vehicle and remove.

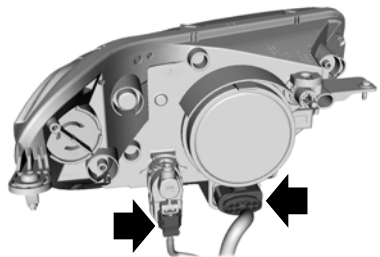

E164963

5. Disconnect the two electrical connectors.

# Maintenance

**Note:** When fitting the headlamp, make sure that you reconnect the electrical connector correctly.

**Note:** When fitting the headlamp, make sure that you fully engage the headlamp in the lower fixing point.

## CHANGING A BULB - 4-DOOR

### WARNINGS



Switch the lamps and the ignition off.



Let the bulb cool down before removing it.



Do not touch the bulb glass.

**Note:** Only fit bulbs of the correct specification.

See **Bulb Specification Chart** (page 139).

**Note:** The following instructions describe how to remove the bulbs. Fit replacements in the reverse order unless otherwise stated.

### Headlamp

**Note:** Remove the covers to gain access to the bulbs.

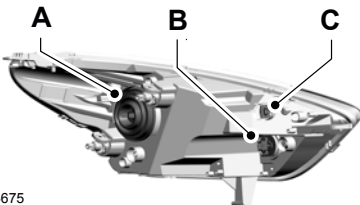

E174675

- A Headlamp low and high beam
- B Direction indicator
- C Position lamp

### Headlamp Low and High Beam

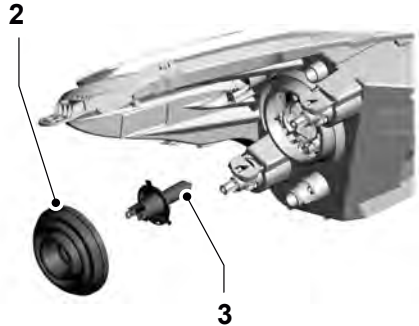

E174676

1. Disconnect the electrical connector.
2. Remove the cover.
3. Release the clip and remove the bulb.

**Note:** Do not touch the bulb glass.

### Position Lamp

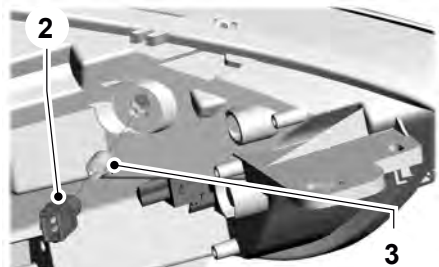

E176168

1. Disconnect the electrical connector.
2. Turn the bulb holder counterclockwise and remove it.
3. Press the bulb in and turn the bulb counterclockwise to remove it.

### Direction Indicator

1. Disconnect the electrical connector.



# Maintenance

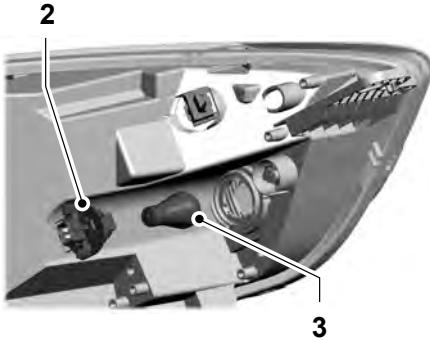

E174677

2. Turn the bulb holder counterclockwise and remove it.
3. Gently press the bulb into the bulb holder, turn it counterclockwise and remove it.

## Front Fog Lamps

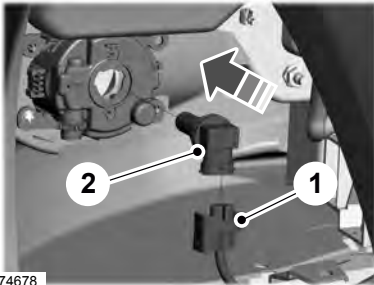

E174678

1. Disconnect electrical connector.
2. Turn the bulb holder counterclockwise and remove it.

**Note:** Do not touch the bulb glass.

## Rear Lamps

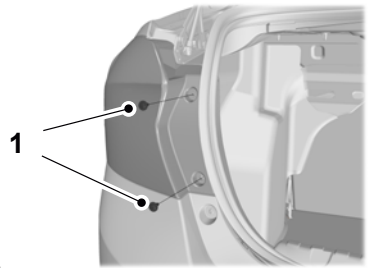

E175762

1. Remove the screws.
2. Remove the lamp.

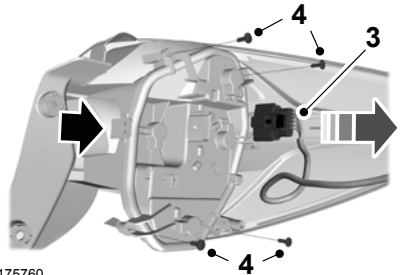

E175760

3. Disconnect the electrical connector.
4. Remove the screws and unclip the bulb holder.

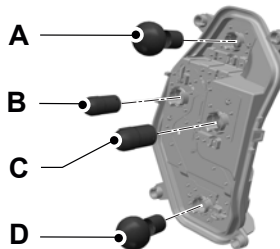

E205819

# Maintenance

5. Gently press the bulb into the bulb holder, turn it counterclockwise and remove it.
  - A. Brake lamp
  - B. Indicator lamp
  - C. Reverse lamp
  - D. Tail lamp and Rear fog lamp

## Central High Mounted Brake Lamp

**Note:** These are not serviceable items, see an authorized dealer if they fail.

## License Plate Lamp

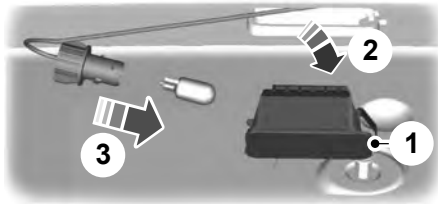

E72789

1. Carefully release the spring clip.
2. Remove the lamp.
3. Remove the bulb.

## Interior Lamp

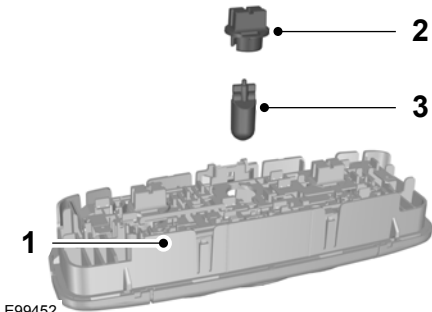

E99452

1. Carefully remove the lamp.
2. Turn the bulb holder counterclockwise and remove it.
3. Remove the bulb.

## Luggage Compartment Lamp, Footwell Lamp and Liftgate Lamp



E72784

1. Carefully pry out the lamp.
2. Remove the bulb.

## CHANGING A BULB - 5-DOOR

### WARNINGS

- ⚠ Switch the lamps and the ignition off.
- ⚠ Let the bulb cool down before removing it.
- ⚠ Do not touch the bulb glass.

**Note:** Only fit bulbs of the correct specification.

See **Bulb Specification Chart** (page 139).

# Maintenance

**Note:** The following instructions describe how to remove the bulbs. Fit replacements in the reverse order unless otherwise stated.

## Headlamp

**Note:** Remove the covers to gain access to the bulbs.

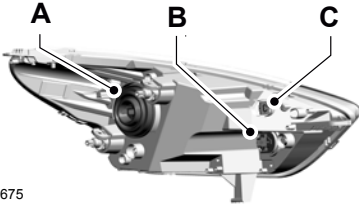

E174675

- A Headlamp low and high beam
- B Direction indicator
- C Position lamp

## Headlamp Low and High Beam

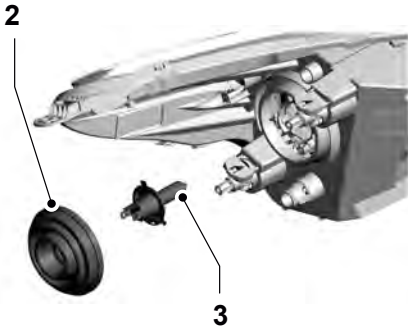

E174676

1. Disconnect the electrical connector.
2. Remove the cover.
3. Release the clip and remove the bulb.

**Note:** Do not touch the bulb glass.

## Position Lamp

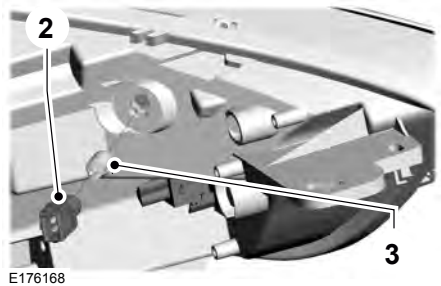

E176168

1. Disconnect the electrical connector.
2. Turn the bulb holder counterclockwise and remove it.
3. Press the bulb in and turn the bulb counterclockwise to remove it.

## Direction Indicator

1. Disconnect the electrical connector.

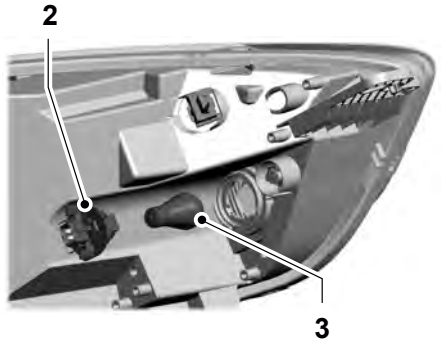

E174677

2. Turn the bulb holder counterclockwise and remove it.
3. Gently press the bulb into the bulb holder, turn it counterclockwise and remove it.

# Maintenance

## Front Fog Lamps

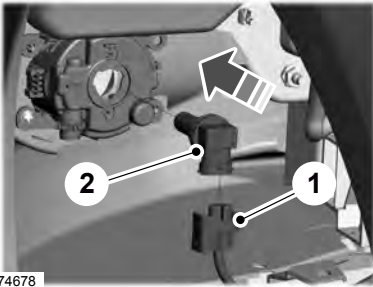

1. Disconnect electrical connector.
2. Turn the bulb holder counterclockwise and remove it.

**Note:** Do not touch the bulb glass.

## Rear Lamps

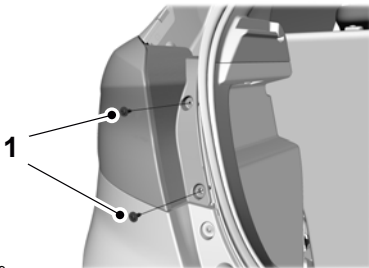

1. Remove the screws.
2. Remove the lamp.

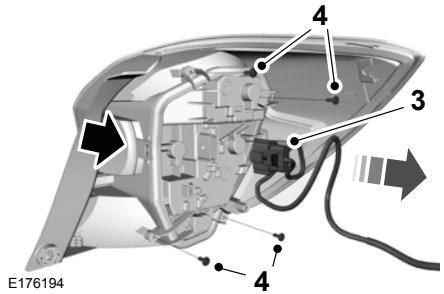

3. Disconnect the electrical connector.
4. Remove the screws and unclip the bulb holder.

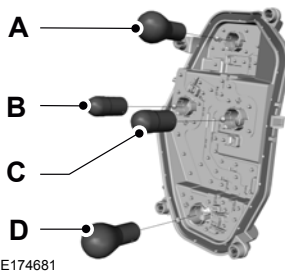

5. Gently press the bulb into the bulb holder, turn it counterclockwise and remove it.
- A. Brake lamp
  - B. Indicator lamp
  - C. Reverse lamp
  - D. Tail lamp and Rear fog lamp

## Central High Mounted Brake Lamp

**Note:** These are not serviceable items, see an authorized dealer if they fail.

# Maintenance

## License Plate Lamp

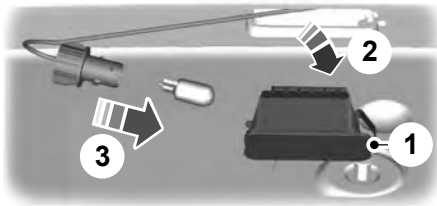

1. Carefully remove the lamp.
2. Turn the bulb holder counterclockwise and remove it.
3. Remove the bulb.

## Luggage Compartment Lamp, Footwell Lamp and Liftgate Lamp

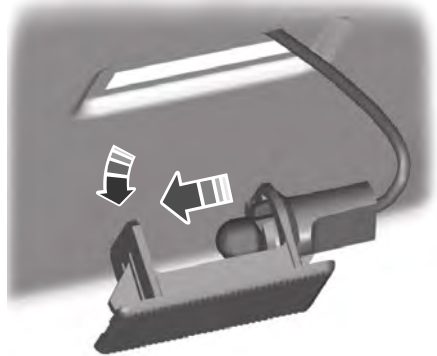

E72789

1. Carefully release the spring clip.
2. Remove the lamp.
3. Remove the bulb.

## Interior Lamp

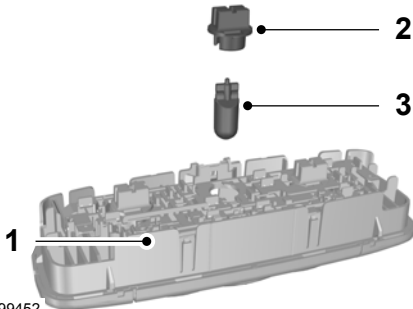

E72784

1. Carefully pry out the lamp.
2. Remove the bulb.

E99452

## BULB SPECIFICATION CHART

Lamp	Specification	Power (watt)
Front direction indicator	PY21W	21
Headlamp high beam / Low Beam	H4	55/60
Front position lamp	W5W	5
Front fog lamp	H11	55
Rear fog / position lamp	P21/4W	21/4

# Maintenance

Lamp	Specification	Power (watt)
Rear direction indicator	RY10W	10
Rear stop lamp	P21W	21
Reversing lamp	R10W	10
License plate lamp	W5W	5
Dome Lamp	W6W	6
Luggage compartment lamp	W6W	6
Center high mounted stop lamp	W16W	16

**Note:** *On some vehicles the lamps are LED. These are not serviceable items, please consult your authorized dealer if they fail.*

## CHANGING THE ENGINE AIR FILTER

### WARNING



To reduce the risk of vehicle damage and/or personal burn injuries do not start your engine with the air cleaner removed and do not remove it while the engine is running.

**Note:** *Failure to use the correct air filter element may result in severe engine damage.*

### Changing the Air Filter Element

- Remove the four screws that secure the air filter housing cover.
- Carefully separate the two halves of the air filter housing.
- Remove the air filter element from the air filter housing.
- Wipe the air filter housing and cover clean to remove any dirt or debris and to ensure good sealing.
- Install a new air filter element. Be careful not to crimp the filter element edges between the air filter housing and cover. This could cause filter damage and allow unfiltered air to enter the engine if not properly seated.
- Replace the air filter housing cover and install the screws.

# Vehicle Care

---

## CLEANING THE EXTERIOR

**Note:** If you use a car wash with a waxing cycle, make sure that you remove the wax from the windshield and the wiper blades.

**Note:** Prior to using a car wash facility check the suitability of it for your vehicle.

**Note:** Some car washes use water at high pressure. Due to this, water droplets may enter inside your vehicle and could also damage certain parts of your vehicle.

**Note:** Remove the aerial before using an automatic car wash.

**Note:** Switch the heater blower off to prevent contamination of the fresh air filter.

We recommend that you wash your vehicle with a sponge and lukewarm water containing a car shampoo.

### Cleaning the Headlamps

**Note:** Do not scrape the headlamp lenses or use abrasives, alcoholic solvents or chemical solvents to clean them.

**Note:** Do not wipe the headlamps when they are dry.

### Cleaning the Rear Window

**Note:** Do not scrape the inside of the rear window or use abrasives or chemical solvents to clean it.

Use a clean, lint free cloth or a damp chamois leather to clean the inside of the rear window.

### Cleaning the Chrome Trim

**Note:** Do not use abrasives or chemical solvents. Use soapy water.

**Note:** Do not apply cleaning product to hot surfaces and do not leave cleaning product on chrome surfaces for a period of time exceeding that which is recommended.

**Note:** Industrial-strength (heavy-duty) cleaners, or cleaning chemicals, may cause damage over a period of time.

## Body Paintwork Preservation

### WARNINGS



Do not polish your vehicle in strong sunshine.



Do not allow polish to touch plastic surfaces. It could be difficult to remove.



Do not apply polish to the windshield or rear window. This could cause the wipers to become noisy and they may not clear the window properly.

We recommend that you wax the paintwork once or twice a year.

## CLEANING THE ENGINE

### WARNING



Due to the different materials found in the engine compartment, avoid using chemical cleaning products, aggressive detergents, degreasers, and acid and alkaline products that, due to their corrosive action, may be aggressive to certain components. Water steam cleaning should also be avoided.

**Note:** During the engine compartment wash, do not remove the transparent label that protects the VIN code. Engine oil, brake fluid, radiator additive, batteries and tires should be packed and stored in facilities especially prepared for handling industrial waste. Do not dispose of these items in public sewer systems or with domestic garbage. Environment preservation is a responsibility shared by all. You too should do your share.

# Vehicle Care

---

It is recommended to avoid frequent engine washes. However, when you do wash the engine, be careful not to use strong jets of water on the engine. Never wash a hot or running engine with cold water, because the thermal shock on warm surfaces may damage the engine. The air conditioned condenser and the radiator have aluminum fins that may be deformed when washed with high-pressure water jets. To avoid damages, wash only with low-pressure water jets.

**Note:** Do not spill water, soap, or any other product on the generator and the starter motor. They may be damaged from the contact with liquids.

When washing:

- Take care when using a power washer to clean the engine. The high-pressure fluid could penetrate the sealed parts and cause damage.
- Do not spray a hot engine with cold water to avoid cracking the engine block or other engine components.
- Never wash or rinse the engine while it is hot or running; water in the running engine may cause internal damage.
- Never wash or rinse any ignition coil, spark plug wire or spark plug well, or the area in and around these locations.
- Cover the battery, power distribution box and air filter assembly to prevent water damage when cleaning the engine.

## CLEANING THE INTERIOR

**Note:** Do not allow air fresheners and hand sanitizers to spill on interior surfaces. If a spill occurs, wipe off immediately. Damage may not be covered by your warranty.

## Seatbelts

**Note:** Do not use abrasives, or chemical solvents to clean them.

**Note:** Do not allow moisture to penetrate the seatbelt retractor mechanism.

**Note:** Cleaning may safely be carried out using mild soap and water. Let them dry naturally, away from artificial heat.

## Instrument Cluster Screens, LCD Screens and Radio Screens

**Note:** Do not use abrasives, alcoholic solvents or chemical solvents to clean the instrument cluster screens, LCD screens or radio screens. These cleaning products can damage the screens.

Clean the instrument panel and cluster lens with a clean, damp and soft cloth, then use a clean, dry and soft cloth to dry these areas.

## Rear Windows

**Note:** Do not use any abrasive materials to clean the interior of the rear windows.

**Note:** Do not install stickers or labels to the interior of the rear windows.

## CLEANING THE ALLOY WHEELS

**Note:** Do not apply a cleaning chemical to warm or hot wheel rims and covers.

**Note:** Industrial-strength (heavy-duty) cleaners, or cleaning chemicals, in combination with brush agitation to remove brake dust and dirt, could wear away the clear coat finish over a period of time.

**Note:** Do not use hydrofluoric acid-based or high caustic-based wheel cleaners, steel wool, fuels or strong household detergent.



# Vehicle Care

---

**Note:** *If you intend parking your vehicle for an extended period after cleaning the wheels with a wheel cleaner, drive your vehicle for a few minutes before doing so. This will reduce the risk of increased corrosion of the brake discs, brake pads and linings.*

**Note:** *Some automatic car washes may cause damage to the finish on your wheel rims and covers.*

Alloy wheels and wheel covers are coated with a clear coat paint finish. To maintain their condition we recommend that you:

- Clean them weekly with the recommended wheel and tire cleaner.
- Use a sponge to remove heavy deposits of dirt and brake dust accumulation.
- Rinse them thoroughly with a pressurized stream of water when you have completed the cleaning process.

We recommend that you use Ford service wheel cleaner. Make sure that you read and follow the manufacturer's instructions.

Using other non-recommended cleaning products can result in severe and permanent cosmetic damage.

## VEHICLE STORAGE

If you plan on storing your vehicle for 30 days or more, read the following maintenance recommendations to make sure your vehicle stays in good operating condition.

We engineer and test all motor vehicles and their components for reliable, regular driving. Under various conditions, long-term storage may lead to degraded engine performance or failure unless you use specific precautions to preserve engine components.

## General

- Store all vehicles in a dry, ventilated place.
- Protect from sunlight, if possible.
- If vehicles are stored outside, they require regular maintenance to protect against rust and damage.

## Body

- Wash your vehicle thoroughly to remove dirt, grease, oil, tar or mud from exterior surfaces, rear-wheel housing and the underside of front fenders.
- Periodically wash your vehicle if it is stored in exposed locations.
- Touch-up exposed or primed metal to prevent rust.
- Cover chrome and stainless steel parts with a thick coat of auto wax to prevent discoloration. Re-wax as necessary when you wash your vehicle.
- Lubricate all hood, door and luggage compartment hinges and latches with a light grade oil.
- Cover interior trim to prevent fading.
- Keep all rubber parts free from oil and solvents.

## Engine

- Change the engine oil and filter prior to storage because used engine oil contains contaminants which may cause engine damage.
- Start the engine every 15 days for a minimum of 15 minutes. Run at fast idle with the climate controls set to defrost until the engine reaches normal operating temperature.

# Vehicle Care

---

- With your foot on the brake, shift through all the gears while the engine is running.
- We recommend that you change the engine oil before you use your vehicle again.

## Fuel system

- Fill the fuel tank with high-quality fuel until the maximum of the third automatic shutoff of the fuel pump nozzle.

## Cooling system

- Protect against freezing temperatures.
- When removing your vehicle from storage, check coolant fluid level. Confirm that there are no cooling system leaks and that fluid is at the recommended level.

## Battery

- Check and recharge as necessary. Keep connections clean.
- If storing your vehicle for more than 30 days without recharging the battery, we recommend that you disconnect the battery cables to maintain battery charge for quick starting.

**Note:** *It is necessary to reset memory features if battery cables are disconnected.*

## Brakes

- Make sure the brakes and parking brake release fully.

## Tires

- Maintain recommended air pressure.

## Miscellaneous

- Make sure all linkages, cables, levers and pins under your vehicle are covered with grease to prevent rust.
- Move vehicles at least 7.5 m every 15 days to lubricate working parts and prevent corrosion.

## Removing Vehicle From Storage

When your vehicle is ready to come out of storage, do the following:

- Wash your vehicle to remove any dirt or grease film build-up on window surfaces.
- Check windshield wipers for any deterioration.
- Check under the hood for any foreign material that may have collected during storage such as mice or squirrel nests.
- Check the exhaust for any foreign material that may have collected during storage.
- Check tire pressures and set tire inflation per the Tire Label.
- Check brake pedal operation. Drive your vehicle 4.5 m back and forth to remove rust build-up.
- Check fluid levels (including coolant, oil and gas) to make sure there are no leaks, and fluids are at recommended levels.
- If you remove the battery, clean the battery cable ends and check for damage.

Contact an authorized dealer if you have any concerns or issues.

# Wheels and Tires

---

## GENERAL INFORMATION

Your vehicle may have an adhesive label with tire pressure data, located in the driver's door opening.

Check and set the tire pressure when the tires are cold.

**Note:** *Check your tire pressures regularly to optimize fuel economy.*

**Note:** *Use only approved wheel and tire sizes. Using other sizes could damage your vehicle.*

**Note:** *If you change the diameter of the tires from the tires fitted at the factory, the speedometer may not display the correct speed.*

**Note:** *If you intend to change the diameter of the tires from the tires fitted at the factory, ask your authorized dealer about the fit.*

## TIRE CARE

**Note:** *When parked next to a curb, do not touch the tire sidewall.*

If you have to park on a hill, do so slowly and with the wheels at right angles with respect to the curb.

Check treads regularly for cuts, foreign bodies or irregular wear. Uneven wear may indicate that the wheel is not aligned with the specification.

Check the tire pressure (including the spare) when they are cold, once every two weeks or before starting a journey.

## Risks on the Road

No matter how carefully you drive, there is always the possibility that you may have a flat tire on the road. Drive slowly to the closest safe area, away from traffic. This may further damage the deflated tire, but your safety is more important.

If you feel a vibration or ride disturbance while driving, or suspect your tire or vehicle is damaged, reduce speed immediately. Drive with caution until you can get off the road safely. Stop and check for damage to the tires. If a tire is damaged or deflated, remove the wheel and replace it with the spare wheel.

## Alignment

A bad jolt from hitting the edge of the sidewalk or a pothole can cause the front tires to become misaligned or damaged. If your vehicle seems to pull to one side while driving, the wheels may have lost alignment. Have an authorized dealer periodically check the wheel alignment. Misalignment of the front or rear wheels can cause uneven or rapid tire wear and must be corrected by an authorized dealer. The drive wheels on vehicles and those with an independent rear suspension may require alignment of the four wheels.

An unbalanced tire and wheel assembly may result in uneven tire wear.

**Note:** *Tire failure due to a lack of alignment or balance is not covered under warranty.*

**Note:** *Alignment and balance is the responsibility of the owner of the vehicle.*

## Tire Rotation

**Note:** *If the tires have irregular or premature wear, check the alignment and wheel balancing or correct any mechanical problems that could arise prior to the rotation of the wheels.*

**Note:** *After rotating your tires, check and adjust the tire pressure according to the requirements of the vehicle.*

# Wheels and Tires

To make sure that the front and rear tires wear evenly and last longer, we recommend rotating the tires at regular intervals, as described in the Scheduled Maintenance chapter. Rotate the wheels as shown in the chart at regular intervals of 10,000 km.

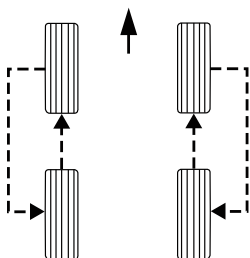

E157543

## CHANGING A ROAD WHEEL

### Lug Nuts

You can obtain a replacement locking lug nut key and replacement locking lug nuts from your dealer using the reference number certificate.

### Vehicles With a Spare Wheel

If the spare wheel is exactly the same type and size as the other fitted road wheels, you can replace the existing road wheel with the spare wheel and continue to drive in the normal manner.

If the spare wheel is different to the other road wheels, it will carry a yellow label with the appropriate speed limit.

Refer to the following information before changing the road wheel.

#### WARNINGS



Drive the shortest possible distances.

#### WARNINGS



Do not fit more than one spare wheel on your vehicle at any one time.



Do not carry out any tire repairs on a spare wheel.



Do not drive through an automatic car wash.



If you are unsure what type of spare wheel you have do not exceed 80 km/h



The ground clearance of your vehicle may be reduced. Take care when parking next to a curb.

**Note:** Your vehicle may exhibit some unusual driving characteristics.

## Vehicle Jack

#### WARNINGS



The vehicle jack supplied with your vehicle should only be used when changing a wheel in emergency situations.



Before using the vehicle jack, check that it is not damaged or deformed and that the thread is lubricated and free from foreign matter.



Never place anything between the jack and the ground, or the jack and your vehicle.

**Note:** Use a jack with a minimum lifting capacity of 1.5 tonnes and a lifting plate with a minimum diameter of 80 mm.

### Removing and Stowing the Vehicle Jack and Wheel Brace

1. Remove the carpeted wheel cover.

# Wheels and Tires



E166564

2. Remove the bolt securing the spare tire by turning it counterclockwise and remove the spare tire.

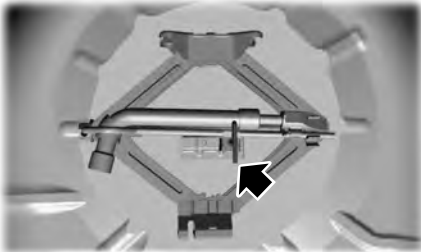

E177389

3. Remove the bolt securing the vehicle jack by turning it counterclockwise and remove the vehicle jack.



E166625

4. To stow the vehicle jack and spare tire properly, align the arrow head on the upper arm of the jack with the mark on the lower arm.



E177389

**Note:** Secure the vehicle jack using the bolt securing in the right hole on the vehicle body.

5. Stow the vehicle jack and secure it by turning the bolt clockwise.

## Wheels and Tires

**Note:** Secure the flat tire using the bolt securing in the left hole on the vehicle body.

6. Stow the flat tire and secure it by turning the bolt clockwise.
7. Refit the carpeted wheel cover.

### Jacking and Lifting Points

#### WARNING



Use only the specified jacking points. If you use other positions, you may damage the body, steering, suspension, engine, braking system or the fuel lines.

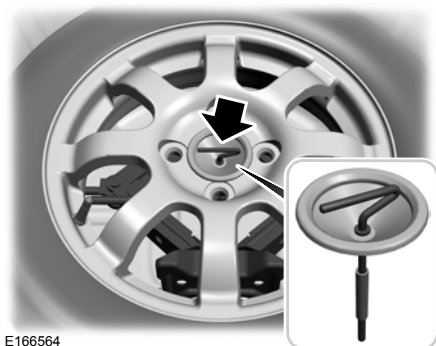

E166564

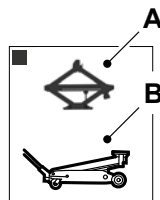
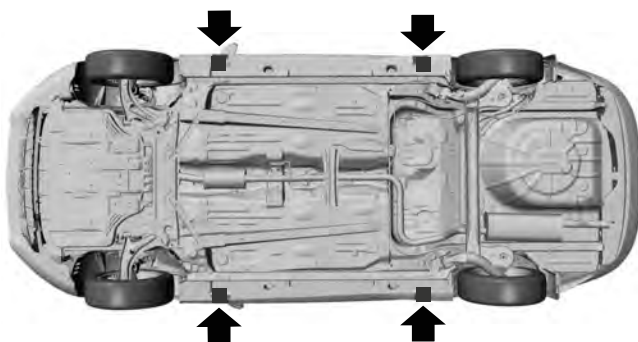

E92658

- A Emergency use only
- B Maintenance

# Wheels and Tires

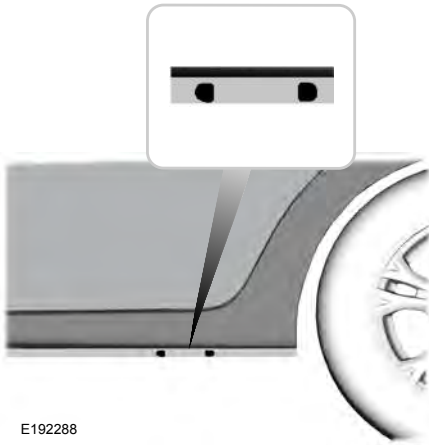

E192288

The jack has to be positioned between the marks engraved in the sill.

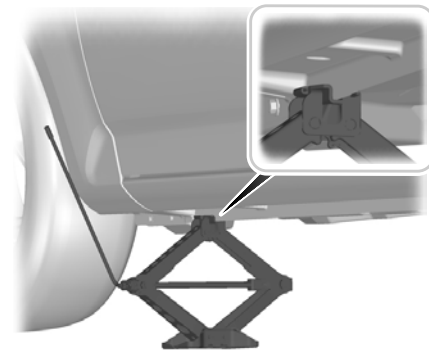

E92932



E93020

## Assembling the Wheel Brace

### WARNING



When returning the wheel brace extension to its original position, take care not to get your fingers caught.

**Note:** Make sure that the wheel brace is fully extended.



E122546

Extend the wheel brace.

## Removing the Wheel Trim

1. Slacken the lug nuts.
2. Jack up your vehicle until the tire is clear of the ground.

# Wheels and Tires

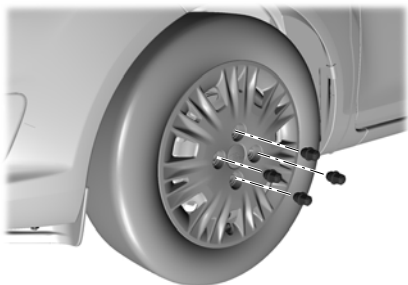









E164275

3. Remove the lug nuts and the wheel trim.

## Removing a Road Wheel

### WARNINGS

-  Park your vehicle in such a position that neither the traffic nor you are hindered or endangered.
-  Set up a warning triangle.
-  Make sure that your vehicle is on firm, level ground with the wheels pointing straight ahead.
-  Switch the ignition off and apply the parking brake.
-  If your vehicle has a manual transmission, move the selector lever to first or reverse gear.
-  Have the passengers leave your vehicle.
-  Secure the diagonally opposite wheel with an appropriate block or wheel chock.
-  Do not work underneath your vehicle when it is supported only by a jack.
-  Make sure that the jack is vertical to the jacking point and the base is flat on the ground.

### WARNINGS

-  Do not lay alloy wheels face down on the ground, this will damage the paint.

**Note:** The spare wheel is located under the floor cover in the luggage compartment.

1. Install the locking lug nut key.

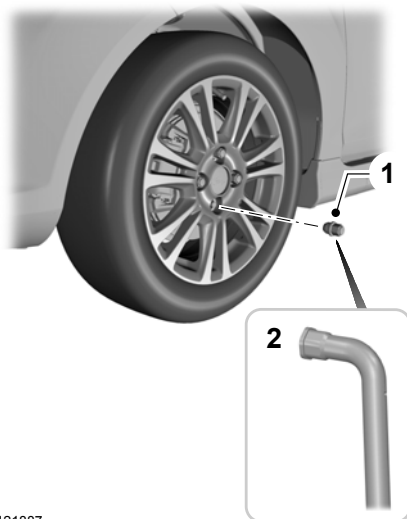

E121887

2. Slacken the lug nuts.
3. Jack up your vehicle until the tire is clear of the ground.
4. Remove the lug nuts and the wheel.



# Wheels and Tires

## Installing a Road Wheel

### WARNINGS



Make sure that the arrows on directional tires point in the direction of rotation when your vehicle is moving forward. If you have to fit a spare wheel with the arrows pointing in the opposite direction, have the tire refitted in the correct direction by an authorized dealer.



Use only approved wheel and tire sizes. Using other sizes could damage the vehicle and will make the National Type Approval invalid. See **Tire Pressures** (page 152).



Make sure there is no lubrication (grease or oil) on the threads or the surface between the wheel lugs and nuts. This can cause the lug nuts to loosen while driving.



Do not fit run flat tires on vehicles that were not originally fitted with them. Contact an authorized dealer for more details about compatibility.

### WARNINGS



Do not install alloy wheels using lug nuts designed for use with steel wheels.



Lug nuts are subject to change. You must make sure that you use only the specific lug nuts and wheels supplied for your vehicle. If in doubt please contact an authorized dealer.

**Note:** *The lug nuts of alloy wheels and spoked steel wheels can also be used for the steel spare wheel for a short time (maximum two weeks).*

**Note:** *Make sure the wheel and hub contact surfaces are free from foreign matter.*

**Note:** *Make sure that the cones on the lug nuts are against the wheel.*

1. Install the wheel and the wheel trim.
2. Install the lug nuts finger tight.
3. Install the locking lug nut key.

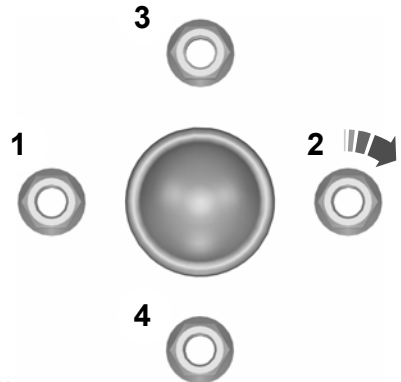

E90589

4. Partially tighten the lug nuts in the sequence shown.
5. Lower your vehicle and remove the jack.
6. Fully tighten the lug nuts in the sequence shown. See **Tire Pressures** (page 152).

### WARNING



Have the lug nuts checked for tightness and the tire pressure checked as soon as possible.

# Wheels and Tires

---

## TIRE PRESSURES

### Wheel Nut Torque

Wheel Type	Torque
All	133 Nm

Tire Size	Normal Load*		Normal Load		Full Load (All Tires)	
	Front	Rear	Front	Rear	Front	Rear
175/ 65R14	2.2 bar	2.2 bar	2.1 bar	2.1 bar	2.4 bar	2.4 bar

\*Only vehicles fitted with Apollo Amazer 3G Tires.

Snow Chains not approved for use on your vehicle.

# Capacities and Specifications

## ENGINE SPECIFICATIONS - 1.2L TIVCT

<b>Item</b>	<b>Specification</b>
Engine position	Front mount/transverse
Engine type	1.2L Ti-VCT
Number and arrangement of cylinders	In-line 4 cylinder
Valves	16
Actuation	Ti-VCT
Cylinder bore	70.6 mm
Stroke	76.5 mm
Compression ratio	11:1
Displacement	1,196 cm <sup>3</sup>
Engine output	88 PS
Maximum torque	112 Nm
Fuel type	Gasoline
Maximum engine speed	6720 rpm
Engine speed at idle	800 ± 50 rpm
Fuel system	PFI
Firing order	1-3-4-2
Ignition system	Electronic
Air induction type	Naturally aspirated engine

# Capacities and Specifications

## ENGINE SPECIFICATIONS - 1.5L TIVCT

<b>Item</b>	<b>Specification</b>
Engine position	Front mount/transverse
Engine type	1.5L Ti-VCT
Number and arrangement of cylinders	In-line 4 cylinder
Valves	16
Actuation	Ti-VCT
Cylinder bore	79 mm
Stroke	76.4 mm
Compression ratio	11:1
Displacement	1,499 cm <sup>3</sup>
Engine output	112 PS
Maximum torque	136 Nm
Fuel type	Gasoline
Maximum engine speed	6720 rpm
Engine speed at idle	800 ± 50 rpm
Fuel system	PFI
Firing order	1-3-4-2
Ignition system	Electronic
Air induction type	Naturally aspirated engine

# Capacities and Specifications

---

## ENGINE SPECIFICATIONS - 1.5L TDCI

<b>Item</b>	<b>Specification</b>
Engine position	Front mount/transverse
Engine type	1.5L DV5
Number and arrangement of cylinders	In-line 4 cylinder
Valves	2 per cylinder
Actuation	DOHC
Cylinder bore	73.5 mm
Stroke	88.3 mm
Compression ratio	16:1
Displacement	1,498 cm <sup>3</sup>
Engine output	100PS
Maximum torque	215 Nm
Fuel type	Diesel
Maximum engine speed	5100 rpm
Engine speed at idle	780 rpm
Fuel system	Common rail direct injection
Firing order	1-3-4-2
Ignition system	Compression
Air induction type	Naturally aspirated engine

# Capacities and Specifications

## WEIGHTS

<b>4 Door</b>			
	<b>1.2L TiVCT (5 Speed Manual Transmission)</b>	<b>1.5L TDCi (5 Speed Manual Transmission)</b>	<b>1.5L TiVCT (Automatic Trans- mission)</b>
Vehicle Kerb Weight*	995 kg to 1,015 kg	1,023 kg to 1,048 kg	1,038 kg to 1,047 kg
Gross Vehicle Weight**	1,450 kg	1,470 kg	1,470 kg

<b>5 Door</b>			
	<b>1.2L TiVCT (5 Speed Manual Transmission)</b>	<b>1.5L TDCi (5 Speed Manual Transmission)</b>	<b>1.5L TiVCT (Automatic Trans- mission)</b>
Vehicle Kerb Weight*	977 kg to 1,009 kg	1,008 kg to 1,041 kg	1,030 kg to 1,037 kg
Gross Vehicle Weight**	1,450 kg	1,450 kg	1,450 kg

\* Weight of complete vehicle with standard equipment and all fluids filled to capacity without occupants, optional equipment, payload or luggage.

\*\* Vehicle Kerb Weight + Max. occupants + All available features + Guaranteed Cargo<sup>1</sup>.

<sup>1</sup>The amount of cargo (luggage or other payload), that can be carried when maximum passengers are present.

# Capacities and Specifications

## VEHICLE DIMENSIONS - 4-DOOR

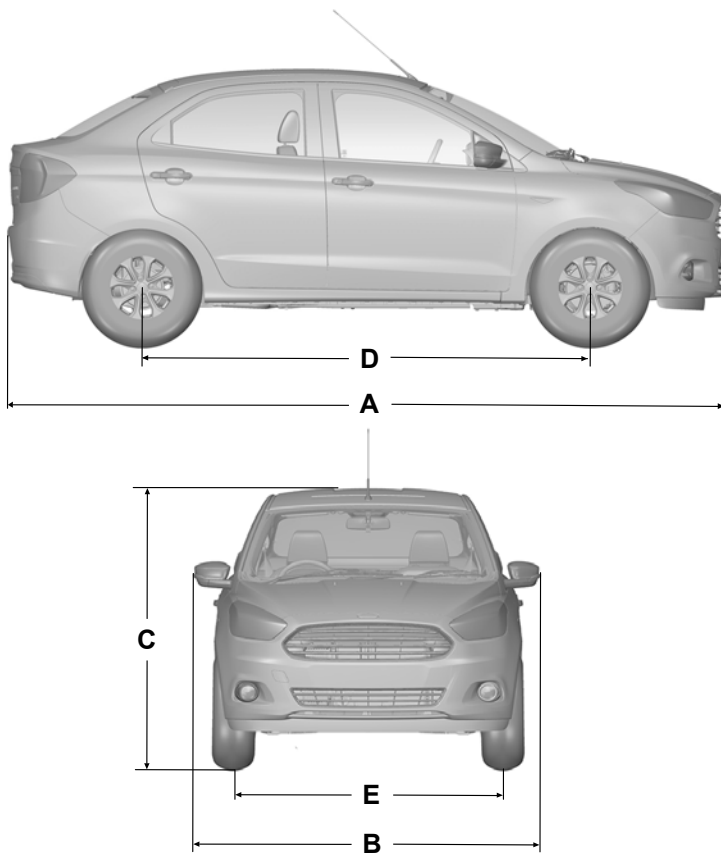

E203607

## Capacities and Specifications

---

<b>Item</b>	<b>Dimension description</b>	<b>Dimension</b>
A	Maximum length	3,995 mm
B	Overall width including exterior mirrors with side repeaters	1,911 mm
B	Overall width including exterior mirrors without side repeaters	1,899 mm
C	Overall height	1,525 mm
D	Wheelbase	2,491 mm
E	Front track	1,487 mm
E	Rear track	1,483 mm

### Capacities

<b>Item</b>	<b>Capacity</b>
Luggage compartment	353 L



# Capacities and Specifications

## VEHICLE DIMENSIONS - 5-DOOR

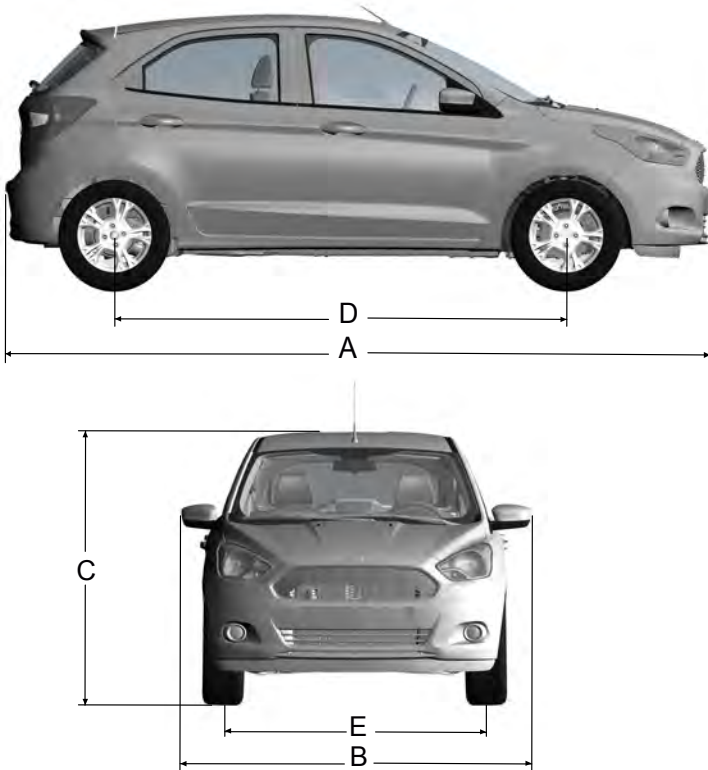

Item	Dimension description	Dimension
A	Maximum length	3,886 mm
B	Overall width including exterior mirrors with side repeaters	1,911 mm
B	Overall width including exterior mirrors without side repeaters	1,899 mm

## Capacities and Specifications

---

<b>Item</b>	<b>Dimension description</b>	<b>Dimension</b>
C	Overall height	1,525 mm
D	Wheelbase	2,491 mm
E	Front track	1,487 mm
E	Rear track	1,483 mm

### Capacities

<b>Item</b>	<b>Capacity</b>
Luggage compartment	257 L

# Capacities and Specifications

## VEHICLE IDENTIFICATION PLATE

**Note:** Your vehicle identification plate design may vary to that shown.

**Note:** The information shown on the vehicle identification plate is dependent upon market requirements.

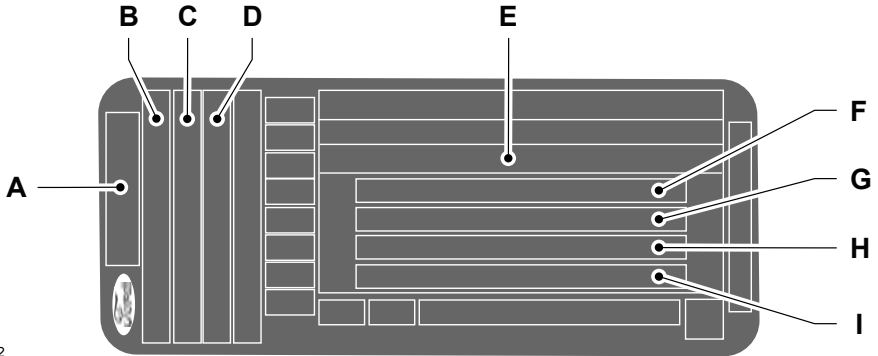

E135662

- A Model
- B Variant
- C Engine designation
- D Engine power and emission level
- E Vehicle identification number
- F Gross vehicle weight
- G Gross train weight
- H Maximum front axle weight
- I Maximum rear axle weight

Your vehicle identification number and maximum weights are shown on a plate, located at the bottom of the lock side of the right-hand door aperture.

## VEHICLE IDENTIFICATION NUMBER

You can find the vehicle identification number at the following locations.

# Capacities and Specifications

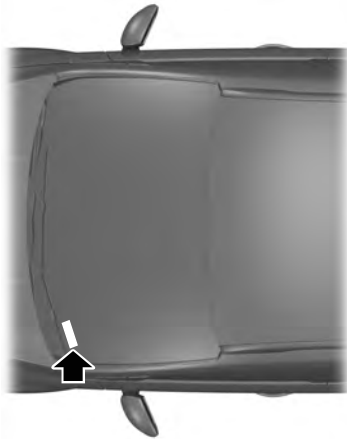

E163915

On the left-hand side of the instrument panel.

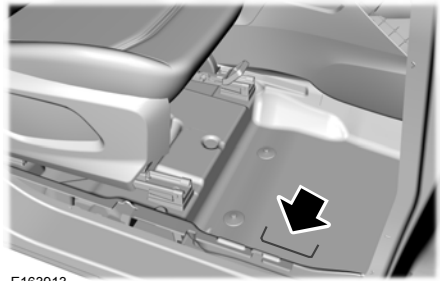

E163913

Stamped into the floor panel on the right-hand side, in front of the front seat.

## CAPACITIES AND SPECIFICATIONS - 1.2L TIVCT/ 1.5L TIVCT

### WARNING



The air conditioning refrigerant system contains refrigerant under high pressure. Only qualified personnel should service the air conditioning refrigerant system. Opening the air conditioning refrigerant system can cause personal injury.

## Capacities

Item	Capacity
Engine oil - including the oil filter	4.05 L
Engine oil - excluding the oil filter	3.75 L
Engine coolant	6.3 L
Fuel tank	42 L
Windshield and rear window washer reservoir	4.5 L
A/C Refrigerant	0.71 kg
A/C Refrigerant oil	130 ml

# Capacities and Specifications

## Adding Engine Oil

Quantity
0.75 L

Quantity of engine oil required to raise the indicated level on the dipstick from minimum to maximum.

## Specifications

### Materials

Name	Specification
Engine Oil - 5W30	WSS-M2C913-D
Engine Oil - 5W20	WSS-M2C948-B
Gear/Transmission Fluid - 75W	WSS-M2C200-D2
Automatic Transmission Fluid	WSS-M2C924-A
Antifreeze	WSS-M97B44-D
Brake Fluid	WSS-M6C65-A2
Windshield Washer Fluid	WSS-M14P19-A
Refrigerant - R134A	WSH-M17B19-A
Refrigerant Oil	WSH-M1C231-B

Only use fluid that meets Ford specifications.

If you are unable to find an engine oil that meets the specification defined by WSS-M2C913-D or WSS-M2C948-B (petrol engines only), it is acceptable to use a SAE 5W-30 engine oil that is defined by ACEA A5/B5.

**Note:** Do not use more than 1 L between scheduled service intervals.

Using oil and fluids that do not meet the defined specification and viscosity grade may lead to:

- Component damage which may not be covered by the vehicle Warranty.
- Longer engine cranking periods.

- Increased emission levels.
- Reduced engine performance.
- Reduced fuel economy.
- Degraded brake performance.

## CAPACITIES AND SPECIFICATIONS - 1.5L TDCI

### WARNING



The air conditioning refrigerant system contains refrigerant under high pressure. Only qualified personnel should service the air conditioning refrigerant system. Opening the air conditioning refrigerant system can cause personal injury.

# Capacities and Specifications

## Capacities

Item	Capacity
Engine oil - including the oil filter	3.8 L
Engine oil - excluding the oil filter	3.4 L
Engine coolant	2.5 L
Fuel tank	40 L
Windshield and rear window washer reservoir	4.5 L
A/C Refrigerant	0.71 kg
A/C Refrigerant oil	130 ml

## Adding Engine Oil

Quantity
1.5 L

Quantity of engine oil required to raise the indicated level on the dipstick from minimum to maximum.

## Specifications

### Materials

Name	Specification
Engine Oil - 5W30	WSS-M2C913-D
Gear/Transmission Fluid - 75W	WSS-M2C200-D2
Automatic Transmission Fluid	WSS-M2C924-A
Antifreeze	WSS-M97B44-D
Brake Fluid	WSS-M6C65-A2
Windshield Washer Fluid	WSS-M14P19-A
Refrigerant - R134A	WSH-M17B19-A
Refrigerant Oil	WSH-M1C231-B

Only use fluid that meets Ford specifications.

If you are unable to find an engine oil that meets the specification defined by WSS-M2C913-D, it is acceptable to use a SAE 5W-30 engine oil that is defined by ACEA A5/B5.

**Note:** Do not use more than 1 L between scheduled service intervals.

# Capacities and Specifications

---

Using oil and fluids that do not meet the defined specification and viscosity grade may lead to:

- Component damage which may not be covered by the vehicle Warranty.
- Longer engine cranking periods.
- Increased emission levels.
- Reduced engine performance.
- Reduced fuel economy.
- Degraded brake performance.

# Audio System

## GENERAL INFORMATION

### Radio Frequencies and Reception Factors

Radio reception factors	
Distance and Strength	The further you travel away from an FM station, the weaker the signal and the weaker the reception.
Terrain	Hills, mountains, tall buildings, bridges, tunnels, freeway overpasses, parking garages, dense tree foliage and thunderstorms can interfere with the reception.
Station overload	When you pass near a radio transmission tower, a stronger signal can override a weaker signal and can cause interference in the audio system.

### CD and CD Player Information

**Note:** *CD units play commercially pressed 4.75-inch (12 centimeter) audio compact discs only. Due to technical incompatibility, certain recordable and re-recordable compact discs may not function correctly when used in Ford CD players.*

**Note:** *Do not insert CDs with homemade paper (adhesive) labels into the CD player as the label may peel and cause the CD to become jammed. You should use a permanent felt tip marker rather than adhesive labels on your homemade CDs. Ballpoint pens may damage CDs. Please contact an authorized dealer for further information.*

**Note:** *Do not use any irregularly shaped discs or discs with a scratch protection film attached.*

Always handle discs by their edges only. Clean the disc with an approved CD cleaner only. Wipe it from the center of the disc toward the edge. Do not clean in a circular motion.

Do not expose discs to direct sunlight or heat sources for extended periods.

### MP3 and WMA Track and Folder Structure

Audio systems capable of recognizing and playing MP3 and WMA individual tracks and folder structures work as follows:

- There are two different modes for MP3 and WMA disc playback: MP3 and WMA track mode (system default) and MP3 and WMA folder mode.
- MP3 and WMA track mode ignores any folder structure on the MP3 and WMA disc. The player numbers each MP3 and WMA track on the disc (noted by the MP3 or WMA file extension) from T001 to a maximum of T255. The maximum number of playable MP3 and WMA files may be less depending on the structure of the CD and exact model of radio present.



# Audio System

---

- MP3 and WMA folder mode represents a folder structure consisting of one level of folders. The CD player numbers all MP3 and WMA tracks on the disc (noted by the MP3 or WMA file extension) and all folders containing MP3 and WMA files, from F001 (folder) T001 (track) to F253 T255.
- Creating discs with only one level of folders helps with navigation through the disc files.

If you are burning your own MP3 and WMA discs, it is important to understand how the system reads the structures you create. While various files may be present, (files with extensions other than MP3 and WMA), only files with the MP3 and WMA extension are played; other files are ignored by the system. This enables you to use the same MP3 and WMA disc for a variety of tasks on your work computer, home computer and your in-vehicle system.

In track mode, the system displays and plays the structure as if it were only one level deep (all MP3 and WMA files play, regardless of being in a specific folder). In folder mode, the system only plays the MP3 and WMA files in the current folder.

## AUDIO UNIT - VEHICLES WITH: AM/FM/CD/SYNC

### WARNING



Driving while distracted can result in loss of vehicle control, crash and injury. We strongly recommend that you use extreme caution when using any device that may take your focus off the road. Your primary responsibility is the safe operation of your vehicle. We recommend against the use of any hand-held device while driving and encourage the use of voice-operated systems when possible. Make sure you are aware of all applicable local laws that may affect the use of electronic devices while driving.

**Note:** *An integrated multi function display is situated above the unit. This shows important information regarding control of your system. Additionally, there are various icons placed around the display screen which light up when a function is active (for example CD, Radio or Aux.)*

# Audio System

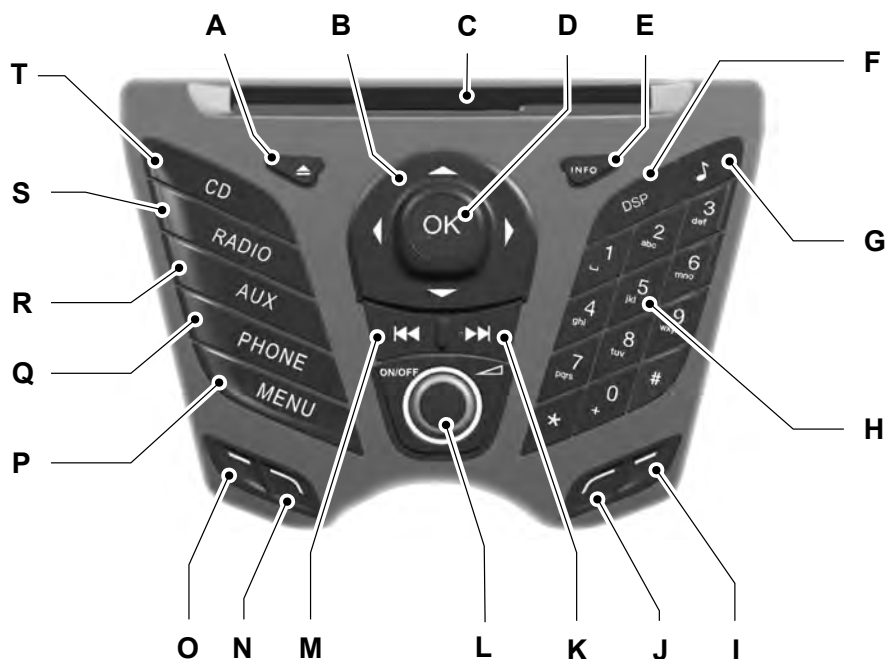

E174695

- A **Eject:** Press the button to eject a CD.
- B **Cursor arrows:** Press a button to scroll through on-screen choices.
- C **CD slot:** Where you insert a CD.
- D **OK:** Press the button to confirm on-screen selections.
- E **INFO:** Press the button to access radio, CD, USB and iPod information.
- F **DSP:** Press the button to access equalizer settings.
- G **Sound:** Press the button to adjust the sound settings for bass, treble, middle, balance and fade.
- H **Numeric keypad:** Press the button to recall a previously stored station. To store a favorite station press and hold until the sound returns. In **PHONE** mode, use these keys to dial the number.
- I **Function button 4:** Press the button to select different functions of the audio system depending on which mode (i.e. radio or CD) you are in.

# Audio System

---

- J **Function button 3:** Press the button to select different functions of the audio system depending on which mode (i.e. radio or CD) you are in.
- K **Seek up:** Press the button to go to the next station up the radio frequency band or the next track on a CD.
- L **On, Off and Volume:** Press the button to switch the audio system on or off. Turn the dial to adjust the volume.
- M **Seek down:** Press the button to go to the next station down the radio frequency band or the previous track on a CD.
- N **Function button 2:** Press the button to select different functions of the audio system depending on which mode (i.e. radio or CD) you are in.
- O **Function button 1:** Press the button to select different functions of the audio system depending on which mode (i.e. radio or CD) you are in.
- P **MENU:** Press the button to access different audio system features.
- Q **PHONE:** Press the button to access the phone feature of the SYNC system by pressing PHONE. For further information please refer to Sync Manual.
- R **AUX:** Press the button to access the AUX, USB and bluetooth audio, it will also cancel the menu or list browsing.
- S **RADIO:** Press the button to select different radio bands, it will also cancel the menu or list browsing.
- T **CD:** Press the button to change source to CD, it will also cancel the menu or list browsing.

# Audio System

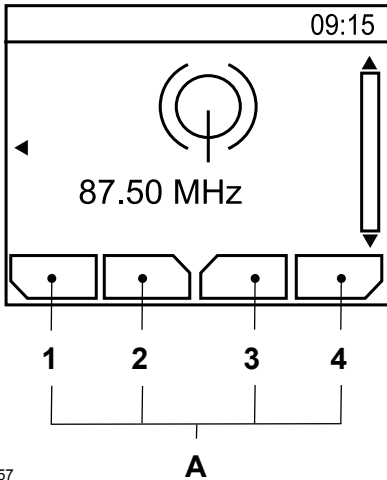

E104157

A Descriptions for function buttons 1-4

Function buttons 1 to 4 are context dependent, and change according to the current unit mode. The description for the current function displays in the screen.

## Sound Button

This will allow you to adjust the sound settings (for example bass, middle and treble).

1. Press the sound button.
2. Use the up and down arrow buttons to select the required setting.
3. Use the left and right arrow buttons to make the necessary adjustment. The display indicates the level selected.
4. Press the **OK** button to confirm the new settings.

## Waveband Button

Press the **RADIO** button to select from the wavebands available.

You can use the selector to return to radio reception when you have been listening to another source.

Alternatively, press the left arrow button to display the available wavebands. Scroll to the required waveband and press **OK**.

## Station Tuning Control

### Seek Tuning

Select a waveband and briefly press one of the seek buttons. The unit will stop at the first station it finds in the direction you have chosen.

### Manual Tuning

1. Press **function button 2**.
2. Use the left and right arrow buttons to tune down or up the waveband in small increments or press and hold to increment quickly, until you find a station you want to listen to.
3. Press **OK** to continue listening to a station.

## Station Preset Buttons

This feature allows you to store your favorite stations, they can be recalled by selecting the appropriate waveband and pressing one of the preset buttons.

1. Select a waveband.
2. Tune to the station required.
3. Press and hold one of the preset buttons. A progress bar and message will appear. When the progress bar completes the station has been stored. The audio unit will also mute momentarily as confirmation.

You can repeat this on each waveband and for each preset button.

# Audio System

---

## Autostore Control

**Note:** *This will store up to a maximum of the 10 strongest signals available, either from the AM or the FM waveband, and overwrite the previously stored stations. You can also store stations manually in the same way as other wavebands.*

- Press and hold the **RADIO** button.
- When the search is complete, sound is restored and the strongest signals are stored on the autostore presets.
- You can also select the same feature by pressing **RADIO** button and selecting **AST**.

## Automatic Volume Control

When available, automatic volume control adjusts the volume level to compensate for engine noise and road speed noise.

1. Press the **MENU** button and select **AUDIO SETTINGS**.
2. Select **ADAPTIVE VOLUME**.

3. Use the left or right arrow button to adjust the setting.
4. Press the **OK** button to confirm your selection.
5. Press the **MENU** button to return.

## AUDIO UNIT - VEHICLES WITH: AM/FM/AUX IN/USB/ BLUETOOTH

### WARNING



Driving while distracted can result in loss of vehicle control, crash and injury. We strongly recommend that you use extreme caution when using any device that may take your focus off the road. Your primary responsibility is the safe operation of your vehicle. We recommend against the use of any handheld device while driving and encourage the use of voice-operated systems when possible. Make sure you are aware of all applicable local laws that may affect the use of electronic devices while driving.

---

# Audio System

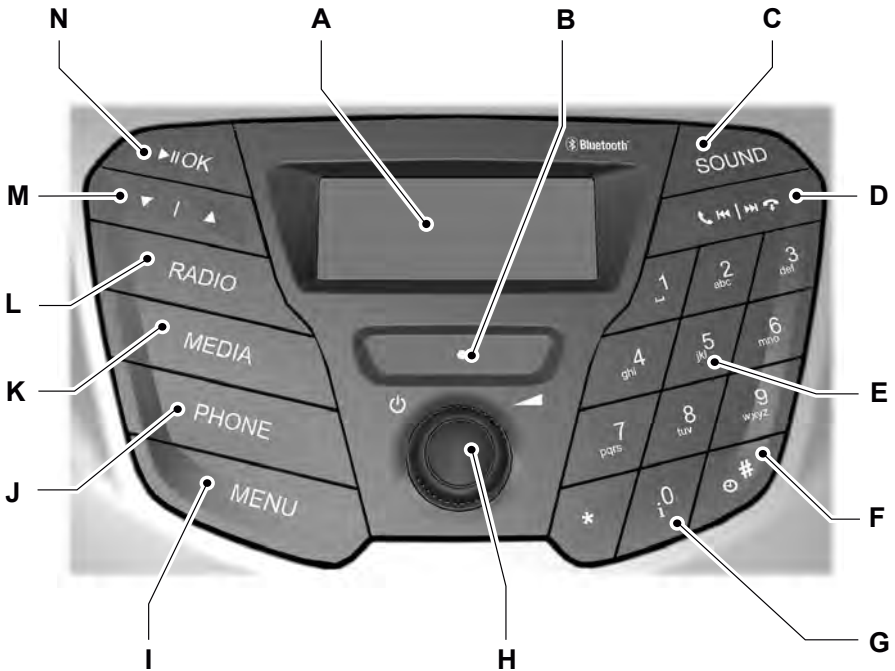

E207454

- A **Display:** Shows the status of the current mode selected.
- B **Microphone:** Use microphone to talk during phone calls.
- C **SOUND:** Press the button to adjust the sound settings for bass, treble, balance and fade.
- D **Seek up:** Press the button to go to the next station up the radio frequency band or the next track. **Seek down:** Press the button to go to the next station down the radio frequency band or the previous track. In Bluetooth audio and USB modes, press the buttons to go to the next or previous track.
- D **Dial and end call:** Press the button to make or end a call.
- E **Numeric keypad:** Press the button to recall a previously stored station. To store a favorite station press and hold until the sound returns. In **PHONE** mode, use these keys to dial the number.

# Audio System

---

- F **Clock:** Press the button to select clock setup.
- G **Information:** Press the button to access the complete information if it does not fit the display.
- H **On, Off and Volume:** Press the button to switch the audio system on or off. Turn the dial to adjust the volume.
- I **MENU:** Press the button to access different audio system features, depending on which mode has been selected.
- J **PHONE:** Press the button to access the Bluetooth phone feature of the system by pressing **PHONE** then **MENU**. When paired further presses of this button will display phone name, signal strength and the battery level.
- K **MEDIA:** Press the button to access Bluetooth audio streaming, USB or Aux input playback.
- L **RADIO:** Press the button to select different radio bands. Press to cancel the menu or list browsing.
- M **Cursor up and down:** Press a button to scroll through on-screen choices. In radio mode press to manual tune.
- N **OK, Play and Pause:** Press the button to confirm on-screen selections. Press to play or pause during playback with compatible external devices.

## Sound Button

This will allow you to adjust the sound settings (for example bass, treble, balance and fade).

1. Press the **SOUND** button repetitively to scroll through the settings.
2. Use the up and down arrow buttons to select the required level.
3. Press the **OK** button to confirm the new settings.

## Waveband Button

Press the **RADIO** button to select from the wavebands available (AM, FM1, FM2).

You can use the button to return to radio reception when you have been listening to another source.

## Station Tuning Control

### Seek Tuning

Select a waveband and briefly press one of the seek buttons. The unit will stop at the first station it finds in the direction you have chosen.

### Manual Tuning

Use the up and down arrow buttons to tune down or up the waveband in small increments or press and hold to increment quickly, until you find a station you want to listen to.

### Station Preset Buttons

This feature allows you to store your favorite stations. They can be recalled by selecting the appropriate waveband and pressing one of the preset buttons.

1. Select a waveband.
2. Tune to the station required.

# Audio System

3. Press and hold one of the preset buttons. A progress bar and message will appear. When the progress bar completes the station has been stored. The audio unit will also mute momentarily as confirmation.

You can repeat this on each waveband and for each preset button.

## Phone

**Note:** *Using the system with the engine off will drain the battery.*

**Note:** *As no common agreement exists, cell phone manufacturers are able to implement a variety of profiles in their Bluetooth devices. Because of this, an incompatibility can occur between the phone and hands free system, which in some cases may significantly degrade the system performance. To avoid this situation, only recommended phones should be used. To check your cell phone's compatibility, refer to your device's manual or visit the regional Ford website.*

This section describes the functions and features of the Bluetooth cell phone hands free system.

The Bluetooth cell phone part of the system provides interaction with the audio system and your cell phone. It allows you to use the audio system to make and receive calls without having to hold your cell phone.

## Bluetooth Setup

**Note:** *Up to five Bluetooth devices can be paired to the system.*

**Note:** *If there is an ongoing call when the phone in use is selected as the new active phone, the call is transferred to the vehicle audio system.*

**Note:** *Even if connected to the system, your phone can still be used in the usual way.*

**Note:** *A call will be disconnected if the audio unit is switched off. If the ignition is switched off the phone call will remain in progress.*

Before you can use your cell phone with your vehicle it must be paired to the audio system.

The following procedure is required before an initial Bluetooth phone connection can be made.

The information display may show your cell phone's battery charge level and signal strength.

## Using the device

**Note:** *To enable or disable the bluetooth connectivity on the radio, press the **MENU** button and go to the bluetooth screen. Use up and down arrow to switch on or off and press **OK** button to confirm.*

1. Press the **PHONE** button and then keep pressing the **MENU** button to scroll to the **ADD DEVICE** display. Press the **OK** button.
2. Select the **VIA DEVICE** and press **OK**.
3. Once **VIA DEVICE** has been selected **FIND FORD BT** will be displayed on the radio display.
4. Note the six digit number displayed.
5. Search for Bluetooth devices using the cell phone. For information on phone settings, refer to your phone user guide.
6. Select **FORD BT** from the list of Bluetooth devices found by your phone.
7. Check if the number on the radio display matches the number displayed on your phone and confirm pairing if prompted
8. Once pairing has been successful **SET PRIMARY** will be displayed on the radio display.



# Audio System

---

9. Press the **OK** button twice to confirm your phone as the primary device for all future connections.
  10. **LOAD PHONEBK** will then be displayed on the audio unit. Press the **OK** button twice to confirm that the contents of your phonebook are downloaded to the system.
  11. The Bluetooth device name is displayed on the audio unit.
9. Press the **OK** button twice to confirm your phone as the primary device for all future connections.
  10. **LOAD PHONEBK** will then be displayed on the audio unit. Press the **OK** button twice to confirm that the contents of your phonebook are downloaded to the system.
  11. The Bluetooth device name is displayed on the audio unit.

**Note:** *Some devices may not accept this pairing procedure. If these instructions do not work for your device, follow the instructions using the radio.*

**Note:** *Once a device is paired as primary, it will automatically connect to the radio, if the bluetooth is enabled on both the radio and the device.*

## Using the radio

1. Enable Bluetooth in your cell phone. For information on phone settings, refer to your phone user guide.
2. Press the **PHONE** button and then keep pressing the **MENU** button to scroll to the **ADD DEVICE** display. Press the **OK** button.
3. Select the **VIA RADIO** and press **OK**.
4. Once **VIA AUDIO** has been selected **SEARCHING** will be displayed on the radio display.
5. Select the desired Bluetooth device from the list found by your audio unit and press **OK**.
6. Type any PIN number in the radio with 6 digits.
7. Check if the number on the radio display matches the number displayed on your phone and confirm pairing if prompted.
8. Once pairing has been successful **SET PRIMARY** will be displayed on the radio display.

## Phonebook Downloading

If your phonebook was not downloaded during initial Bluetooth pairing follow this process:

1. Press the **PHONE** button and then keep pressing the **MENU** button to scroll to the **LOAD PHONEBK** display.
2. Press the **OK** button.

## Deleting a Paired Device or Phone

To remove a paired device follow this process:

1. Press the **PHONE** button and then keep pressing the **MENU** button to scroll to the **DEL DEVICE** display.
2. Press the **OK** button. The first paired device name will be shown. Scroll using the up and down arrow buttons and select the required device name. Select option **YES** using the arrow buttons.
3. Press **OK** to unpair the device.

## Privacy Mode

You can transfer a call from hands free to private mode during an active call.

Press the **MENU** button until **PRIVACY** appears, then press the **OK** button to transfer. To return to hands free mode, press the dial button.

# Audio System

---

## Phone Menu Options

Press the **PHONE** button to select phone mode. Press the **PHONE** button again to display information such as phone name, signal strength and battery level.

When in phone mode, press the **MENU** button to scroll through the various phone options:

- Dial
- Redial.
- Phonebook.
- Call History.
- Add Device.
- Select Device.
- Set Primary.
- Delete Device.
- Bluetooth on and off.
- Load Phonebook.
- Reject on or off

Press the **OK** button to select the required option, and use the up and down arrows to change features or press **PHONE** to exit.

## Making and Receiving Calls

Outgoing calls can be made in Phone mode by:

- Entering a number using the keys on the radio.
- Selecting a contact from the downloaded phonebook.
- Selecting a number or contact from the call history log.
- Using quick dial by pressing one of the radio preset buttons.
- Using the redial function.
- Using the cell phone.

**Note:** *It is necessary to choose the SIM card in the cell phone when using a dual SIM cell phone.*

Incoming calls can be answered by:

- pressing the call pickup button on the audio unit
- using the cell phone.

Calls can be rejected using the end call button on the audio unit or by using the cell phone directly.

## USB

**Note:** *Only use USB Mass-Storage device compliant devices.*

**Note:** *Always switch your audio unit to a different source (for example the radio) before unplugging the USB device.*

**Note:** *Do not install or connect USB hubs or splitters.*

**Note:** *The system is only designed to recognize and read suitable audio files from a USB device that conforms to the USB Mass-Storage device class or an iPod. Not all available USB devices can be guaranteed to function with the system.*

**Note:** *It is possible to connect compatible devices with a trailing USB lead as well as those that plug into the USB socket directly (for example USB memory sticks and pen drives).*

**Note:** *Some USB devices with a higher power consumption may not be compatible (for example some larger hard drives).*

**Note:** *Access time to read the files on the external device will vary depending upon factors such as the file structure, size and device content.*

The audio unit supports a range of external devices. Once connected, control of the external device is possible via the audio unit.

## Operating the USB Device

Connect the device to the audio unit.

# Audio System

Select the USB device as the audio source by pressing the **MEDIA** button until the USB screen appears in the display. If the **AUTOPL** feature is enabled after connecting the USB device, the first track within the first folder will start to play automatically. If the **AUTOPL** feature is disabled, you have to press **OK** button to confirm and start listening to the track. Following audio source switching, the position of playback on the USB device is remembered.

**Note:** *In USB mode, turn the **AUTOPL** on or off by pressing the **MENU** button, go to **AUTOPL** screen and use the up and down arrow to select and press **OK** button to confirm.*

Press the seek up and down keys to skip backward and forward through tracks. Press and hold to fast forward and reverse through the track. You can also select a track by using the numeric keypad. Dial the required track number until complete (for example, 1 then 2 for track 12) or dial the number and directly press **OK** button.

You can change the folder by pressing the **MENU** button repetitively till 'Explore USB' screen, press **OK** and using up and down arrow select your option. Press **OK** to confirm.

## iPod

Connect the iPod to the audio unit.

Select the iPod as the audio source by pressing the **MEDIA** button until **IPOD** appears in the display. After first connecting the iPod, the first track within the first folder will start to play automatically. Following audio source switching, the position of playback on the iPod is remembered.

Press the seek up and down keys to skip backward and forward through tracks.

Press and hold the seek keys to enable fast rewind or fast forward through track content.

On USB mode, by pressing **MENU** button various functions may be controlled from the audio unit including:

- Play all.
- Explore USB.
- Next and previous track select.
- Track seek.
- Shuffle.
- Repeat.
- AUTOPL

**Note:** *Choose the function, on pressing **MENU** button repetitively, press **OK** to go into the function. Use up and down arrow to switch the option (enable or disable) and press **OK** button again to confirm. On 'Play all' function, you just need to press **OK** to enable.*

## Bluetooth Audio Streaming

**Note:** *Make sure the device is paired before using this feature.*

Compatible Bluetooth devices can be connected to the audio unit to playback using the vehicle audio system.

Select the device as the audio source by pressing the **MEDIA** button until **BT AUDIO** appears in the display.

The device playback can be controlled using the audio unit buttons play, pause, next and previous track.

# Audio System

---

## FCC Notice

This device complies with Part 15 of the FCC Rules. Operation is subject to the following two conditions: (1) this device may not cause harmful interference, and (2) this device must accept any interference received, including interference that may cause undesired operation.

FCC ID: A8DGEN3-1D

Changes or modifications not expressly approved by the party responsible for compliance could void the user's authority to operate the equipment.

## COMPACT DISC PLAYER

### Compact Disc Playback

**Note:** *During playback, the display indicates the disc, track and time that have elapsed since the start of the track.*

#### With SYNC

During radio reception, if a disc is loaded, playback starts immediately.

If you switch audio source (Radio, USB, Aux In) and want to play CD again, press **CD** button.

#### Without SYNC

During radio reception, press the **MEDIA** button once to start CD playback.

After a disc is loaded, playback will start immediately.

### Track Selection

#### With SYNC

- Press the seek down button once to replay the current track. If pressed within two seconds of the start of a track, the previous track plays.

- Press the up or down arrow buttons to select the required track, then press **OK**.

You can select a track by using the numeric keypad. Dial the required track number until complete (for example, 1 then 2 for track 12), or dial the number and directly press **OK**.

#### Without SYNC

Press the seek back button once to replay the current track. If pressed within two seconds of the start of a track, the previous track will be selected.

### Fast Forward and Reverse

Press and hold the seek down or up buttons to search backward or forward within the tracks on the disc.

### Shuffle and Random

Random track playback, also known as shuffle, plays all tracks on the CD in random order.

#### With SYNC

Press function button 2.

**Note:** *When an MP3 CD is playing, you can have the system shuffle tracks for the whole CD, or within the current folder. Pressing function button 2 toggles these options.*

Use the seek up or down button to select the next track to shuffle, if required.

#### Without SYNC

1. Press the **MENU** button repeatedly until **SHUFFLE** is displayed.
2. Use the arrow buttons to select **OFF** or **ALL**.
3. Press **OK** button to confirm.

# Audio System

---

When an MP3 CD is playing, options include **SHUFFLE** for the whole CD, or to play all the tracks in the folder in a random order.

## Repeat Compact Disc Tracks

### With SYNC

Press function button 1.

**Note:** *When an MP3 or WMA CD is playing, you can have the system repeat the current track or all tracks within the current folder. Pressing function button 1 toggles these options.*

### Without SYNC

1. Press the **MENU** button repeatedly until **REPEAT** is displayed.
2. Scroll using the arrow buttons.
3. Press **OK** button to confirm.

When an MP3 or WMA CD is playing, options include **REPEAT** for the track, or to repeat all the tracks in the folder.

## Compact Disc Track Scanning

The **SCAN** function allows you to preview each track for approximately five seconds.

Various scan modes are possible, according to the type of CD currently playing.

### With SYNC

Press function button 3.

**Note:** *When an MP3 CD is playing, you can have the system shuffle tracks for the whole CD or within the current folder. Pressing function button 3 toggles these options.*

### Without SYNC

1. Press the **MENU** button and select **CD** mode.
2. Select **SCAN**. This enables the function to be switched on or off.

**Note:** *When an MP3 or WMA CD is playing, options include **SCAN** for the CD or just the tracks in the folder.*

3. Press the **OK** button to stop the scan mode.

## MP3 and WMA File Playback

MP3 (MPEG 1 Audio Layer-3) or WMA (Windows media audio) is a standard technology and format for compressing audio data. This allows a more efficient use of the media.

You can play MP3 files recorded on CD-ROM, CD-R and CD-RW formats. The disc must be in the ISO 9660 level 1 or level 2 format, or Joliet or Romeo in the expansion format. You can also use a disc recorded in multi session.

### ISO 9660 Format

This is the most common international standard for the logical format of files and folders on a CD-ROM.

There are several specification levels. In Level 1, file names must be in the 8.3 format (no more than eight characters in the name, no more than three characters in the extension MP3 and WMA) and in capital letters.

Folder names can be no longer than eight characters. There can be no more than eight folder levels (trees). Level 2 specifications allow file names up to 31 characters long.

Each folder can have up to eight trees.

For Joliet or Romeo in the expansion format, consider these restrictions when configuring your CD writing software.

### Multi Session

This recording method enables adding of data using the track-at-once method.

# Audio System

Conventional CDs begin at a CD control area called the lead-in and end at an area called lead-out. A multi session CD is a CD having multiple sessions, with each segment from lead-in to lead-out regarded as a single session.

CD-Extra: The format that records audio (audio CD data) as tracks on session 1, and records data as tracks on session 2.

Mixed CD: In this format, data records as track 1 and audio (audio CD data) records as track 2.

## File Formats

With formats other than ISO 9660 level 1 and level 2, folder names or file names may not display correctly.

When naming, be sure to add the file extension MP3 or WMA to the file name.

If you put the extension MP3 or WMA to a file other than MP3 or WMA, the unit cannot recognize the file correctly and generates random noise that could damage your speakers.

The following discs take a longer time to start playback.

- A disc recorded with complicated tree structure.
- A disc recorded in multi session.
- A non-finalized disc, where you can add more data.

## Playing a Multi Session Disc

When the first track of the first session is audio CD data only, the audio CD data of the first session plays. Non-audio CD data, MP3 or WMA file information (such as track number and time) displays with no sound.

When the first track of the first session is not audio CD data:

- If an MP3 or WMA file is on the disc, the system skips these file and other data. Audio CD data is not recognized.
- If no MP3 or WMA file is in the disc, nothing plays. Audio CD data is not recognized.

## MP3 and WMA Files Playback Order

The playback order of the folders and files are as shown.

**Note:** *The system skips any folder that does not include an MP3 or WMA file.*

To specify a desired playback order before the folder or file name, input the order by number (for example, 01 or 02) then record the contents onto a disc. The order differs depending on the writing software.

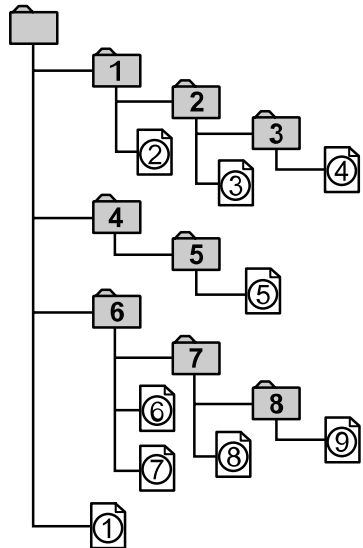

E104206

## ID3 Tag Version 2

The following occurs when an MP3 or WMA file containing a tag plays:

# Audio System

---

- When skipping a portion of a tag (at the beginning of the track) there is no sound output. Skip time changes depending on the tag capacity. Example: At 64 kbytes, it is about 2 seconds (with RealJukebox).
- The displayed elapsed playing time when skipping a portion of the tag is inaccurate. For MP3 files of a bit rate other than 128 kbps, time does not display accurately during playback.
- When an MP3 file is created with MP3 conversion software (such as RealJukebox - a registered trademark of RealNetworks Inc.), the tag generates automatically.

## MP3 or WMA Navigation

You can record MP3 tracks on the CD in several ways. You can place them in the root directory like a conventional audio CD, or in folders that may represent categories, such as album, artist, or genre.

The normal playing sequence on CDs with multiple folders is:

- Play the tracks within the root (top level) first.
- Then the tracks in any folder(s) within the root.
- Then move to the second folder, and so forth.

To navigate to a track:

1. Press the up or down arrow buttons to enter the track list.
2. Navigate the hierarchy using the arrow buttons to select another folder or track (file).
3. Press **OK** to select a highlighted track.

## MP3 and WMA Display Options

When an MP3 or WMA disc is playing, certain information encoded in each track can display. Such information normally includes:

- The file name.
- The folder name.
- ID3 information, which might be the album or artist name.

The unit normally shows the file name that is playing. To select one of the other items of information, press **INFO** repeatedly until the required item appears in the display.

**Note:** *If the ID3 information selected is unavailable, **NO MP3** or **WMA TAG** appears in the display.*

## CD Text Display Options

When an audio disc with CD text is playing, limited information encoded in each track can display. Such information normally includes:

- The disc name.
- The artist name.
- The track name.

**Note:** *You can select these display options in the same way as MP3 displays. **NO DISC NAME** or **NO TRACK NAME** appears in the display if there is no encoded information.*

## Ending Compact Disc Playback

To restore radio reception on all units, press **RADIO**.

**Note:** *The CD does not eject. The disc pauses at the point where radio reception returned.*

To resume CD playback, press **CD** again.

# Audio System

## AUDIO INPUT JACK

### WARNINGS



Driving while distracted can result in loss of vehicle control, accident and injury. We strongly recommend that you use extreme caution when using any device or feature that may take your focus off the road. Your primary responsibility is the safe operation of your vehicle. We recommend against the use of any handheld device while driving and encourage the use of voice-operated systems when possible. Make sure you are aware of all applicable local laws that may affect the use of electronic devices while driving.



For safety reasons, do not connect or adjust the settings on your portable music player while your vehicle is moving.



Store the portable music player in a secure location, such as the center console or the glove box, when your vehicle is in moving. Hard objects may become projectiles in a collision or sudden stop, which may increase the risk of serious injury. The audio extension cable must be long enough to allow the portable music player to be safely stored while your vehicle is moving.

The auxiliary input jack allows you to connect and play music from your portable music player through your vehicle speakers. You can use any portable music player designed for use with headphones. Your audio extension cable must have male one-eighth inch (three and one-half millimeter) connectors at each end.

1. Make sure your vehicle is stationary with the radio and portable music players turned off.

2. Plug the extension cable from the portable music player into the auxiliary input jack.
3. Switch the radio on. Select either a tuned FM station or a CD.
4. Adjust the volume as desired.
5. Switch the portable music player on and adjust its volume to half its maximum level.
6. Press **AUX** until **LINE** or **LINE IN** appears in the display. You should hear music from your device even if it is low.
7. Adjust the volume on your portable music player until it reaches the volume level of the FM station or CD. Do this by switching back and forth between the AUX and FM or CD controls.

### Type 1



E208633

### Type 2



# Audio System



## AUDIO TROUBLESHOOTING

<b>Audio unit display</b>	<b>Rectification</b>
Please check CD	General error message for CD fault conditions, for example cannot read the CD, data-CD inserted, etc. Make sure the disc is loaded correctly. Clean and re-try, or replace disc with known music disc. If error persists contact an authorized dealer.
CD drive malfunction	General error message for CD fault conditions. For example a mechanism fault.
CD drive high temp.	Ambient temperature too hot – unit will not work until it has cooled down.

# Audio System

---

## USB PORT



E208248

The USB port allows you to plug in media playing devices, memory sticks and charge devices (if supported). See **Center Console** (page 77).

## MEDIA HUB (If Equipped)



E192289

## GENERAL INFORMATION

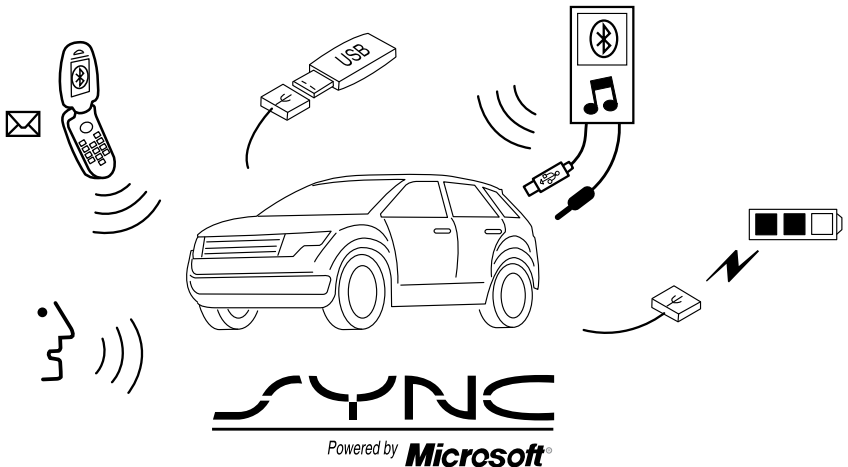

E142598

**Note:** This manual describes product features and options available throughout the range, sometimes even before they are generally available. It may describe options not fitted to your vehicle.

SYNC is an in-vehicle communications system that works with your Bluetooth-enabled cell phone and portable media player. This offers you the following features:

- Send and receive hands-free calls
- Access and play music from your favourite digital media player through easy, voice-activated commands
- Speak to access your Bluetooth-enabled cell phone's contact list.

- Read incoming SMS text messages aloud from your cell phone (This is a phone-dependent feature.)
- Listen to music streaming through your Bluetooth-enabled cell phone
- Use the advanced voice recognition system.
- Charge your USB device (if your device supports this).

**Note:** Make sure that you refer your device's user guide before using it with SYNC.

## WARNING



Operating certain parts of this system while driving can distract your attention away from the road, and possibly cause an accident or other serious consequences. Do not change system settings or enter data non-verbally (using your hands) while driving. Stop the vehicle in a safe and legal manner before attempting these operations. This is important since while setting up or changing some functions you might be required to distract your attention away from the road and remove your hands from the wheel.

## Support

For further support, see an authorized dealer. For more information, visit the regional Ford website [www.fordsync.com](http://www.fordsync.com).

## Menu Structure - SYNC™ Settings

The SYNC system settings can be accessed using the **MENU** button on the audio or navigation unit.

**Note:** *Some options are model-dependent features and may appear slightly different or not at all if the items are optional. See an authorized dealer.*

Menu			
SYNC - Settings	Bluetooth on		
	BT Devices		
	Set defaults		
	Master reset		
	Install on SYNC		
	System info		
	Voice settings	Interact. mode	Novice
			Advanced
		Confirm prompt	
		Phone candidate	
Media candidate			
Browse USB			
SYNC Applications	Mobile Apps (If Equipped)		
	Emergency Assistance (If Equipped)	On	
Off			
Audio settings			
Vehicle settings			

Menu	
Clock settings	
Display settings	
System check	
MyKey (If Equipped)	

## Bluetooth On

Allows you to turn the Bluetooth® feature on/off.

## BT Devices

Allows you to add, delete, connect, disconnect and set a primary device.

## Set defaults

Allows you to return to the factory default settings. This operation will **NOT** erase your indexed information. (phonebook, call history, text messages and paired devices)

## Master reset

Allows you to completely erase **ALL** information stored on SYNC (all phonebook, call history, text messages and all paired devices) and return to the factory default settings.

## Install on SYNC

Allows you to install applications you have downloaded.

## System Info

Allows you to access vehicle SYNC system's version information.

## Voice settings

Allows you to customize your VR (Voice Recognition) system to provide more or less instruction and feedback. See **Using Voice Recognition** (page 190).

## Browse USB

Allows you to explore through all supported digital media on your media device connected to the USB port.

## Mobile Apps (If Equipped)

The system enables voice and manual control of Ford Applink™ enabled smartphone apps. Once an app is running through Ford Applink™, you can control main features of the app through voice commands and manual controls. See **SYNC™ Applications and Services** (page 200).

## Emergency Assistance (If Equipped)

In the event of a crash which deploys an airbag or activates the fuel pump shut-off, the system may contact the emergency services through a paired and connected cell phone. See **SYNC™ Applications and Services** (page 200).

## Menu Structure - SYNC™-Phone

The SYNC phone settings can be accessed using the **PHONE** button on the audio or navigation unit.

<b>Phone</b>		
Dial a number		
Redial		
Phonebook		
Call history	Incoming calls	
	Outgoing calls	
	Missed calls	
Speed Dial		
Text messaging		
BT Devices		
Phone settings	Set as master	
	Phonebook pref.	Auto download
		Add contacts
		Download now
		Delete
	Set ringtone	Ringtone 1
		Ringtone 2
		Ringtone 3
		Phone ringtone
		Ringtone off
Phone status		
Text msg notify		

## Text messaging

### WARNING



Local laws may prohibit some or all of the text messaging functions while driving. Check your local road rules before using these functions.

Allows you to send, download and delete text messages.

### **Dial a number**

Allows you to enter phone number and call this number.

### **Redial**

Allows you to call the last dialed number.

## Phonebook

Allows you to access the downloaded phonebook.

## Call history

Allows you to access any previously dialed, received or missed calls while your phone has been connected to SYNC.

## Speed dial

Allows you to call numbers which have been stored as speed dial.

## BT Devices

Allows you to add, delete, connect, disconnect and set a primary device.

## Phone settings

Allows you to change or set up your ringtone, text message notifications, phone book, etc.

## Set as master

Allows you to connect with the primary phone at every ignition cycle. When a phone is selected as master, it appears first in the list and is marked with an "\*".

## Phonebook pref.

- Auto Download: Automatically download the phonebook each time the phone connects to SYNC. (Downloading time is phone-dependent and quantity-dependent.)
- Add Contacts: allows you to add more contacts to the phonebook.
- Download now: allows you to download your current phonebook into SYNC immediately.
- Delete: allows you to delete all the contacts in current paired phone.

## Set ringtone

Allows you to change or set up your ringtone.

## Phone status

Shows your phone's number, provider, battery status, etc.

## Text msg notify

Allows you to set an audible tone for the incoming text message.

## Driving Restrictions

For your safety, certain features are speed-dependent and restricted when your vehicle is traveling over 5 km/h.

## Safety Information

### WARNING



Driving while distracted can result in loss of vehicle control, crash and injury. We strongly recommend that you use extreme caution when using any device that may take your focus off the road. Your primary responsibility is the safe operation of your vehicle. We recommend against the use of any hand-held device while driving and encourage the use of voice-operated systems when possible. Make sure you are aware of all applicable local laws that may affect the use of electronic devices while driving.

When using SYNC:

- Do not operate playing devices if the power cords or cables are broken, split or damaged. Carefully place cords and cables where they cannot be stepped on or interfere with the operation of pedals, seats, compartments or safe driving abilities.
- Do not leave playing devices in the vehicle during extreme conditions as it can damage them. Refer to your device's user guide for further information.
- Do not attempt to service or repair the system. See your authorized dealer.

## Privacy Information

When a cell phone is connected to SYNC, the system creates a profile within your vehicle that is linked to that cell phone. This profile is created in order to offer more mobile features and to operate more efficiently. Among other things, this profile may contain data about your cell phone book, text messages (read and unread), and call history, including history of calls when your cell phone was not connected to the system. In addition, if you connect a media device, the system creates and retains an index of supported media content. The system also records a short development log of approximately 10 minutes of all recent system activity. The log profile and other system data may be used to improve the system and help diagnose any problems that may occur.

The mobile profile, media device index, and development log will remain in the vehicle unless you delete it and are generally accessible only in the vehicle when the cell phone or media player is connected. If you no longer plan to use the system or the vehicle, we recommend you to perform a Master Reset to erase all stored information.

System data cannot be accessed without special equipment and access to the vehicle's SYNC module. Ford Motor Company will not access the system data for any purpose other than as described absent consent, a court order, or where required by law enforcement, other government authorities, or other third parties acting with lawful authority. Other parties may seek to access the information independently of Ford Motor Company.

## USING VOICE RECOGNITION

Your SYNC system comes equipped with an advanced voice recognition system. This system helps you control many features using voice commands. This allows you to keep your hands on the wheel and focus on what is in front of you.

### Initiating a Voice Session



Listening icon



Push the **VOICE BUTTON**; a tone sounds and "**Listening**" icon appears in the display. Say any of the following:

Say	If You Want To
"PHONE"	Use the connected phone.
"USB"	Access the device connected to your USB port.
"BLUETOOTH AUDIO"	Stream audio from your phone.
"LINE IN"	Access the device connected to the auxiliary input jack.
"VOICE SETTINGS"	Adjust the level of voice interaction and feedback.
"READ MESSAGE"	Hear the most recent incoming SMS text message.
"HELP"	Hear a list of voice commands available in the current mode.
"CANCEL"	Cancel the requested action.



## Helpful Hints

- Any external noise such as wind noise and road vibrations may prevent the system from correctly recognizing the voice commands.
- After pressing the **VOICE BUTTON**, wait until after the tone sounds and "**Listening**" icon appears before saying a command. Any command spoken prior to this will not be recognised by the system.
- Speak normally, without long pauses between words.
- The system can be interrupted at any time by pressing the **VOICE BUTTON** and say "HELP" for assistance.
- Speak out the voice commands from a considerable distance from the SYNC microphone.

- To cancel the on going voice session, say "CANCEL" or press seek up or seek down arrow button.
- To say the commands directly without listening to system prompts, press the **VOICE BUTTON** once to abort the prompts.

## System Interaction and Feedback

The system provides feedback through audible tones, prompts, questions and spoken confirmations depending on the situation and the chosen level of interaction (voice settings). You can customize the voice recognition system to provide more or less instruction and feedback.

The default setting is to a standard interaction mode in order to help you learn to use the system. You can change these settings at any time.

### Adjusting the Interaction Level



Push the **VOICE BUTTON** and say any of the following:

When You Say	The System
"INTERACTION MODE ADVANCED"	Provides less audible interaction and more tone prompts.
"INTERACTION MODE NOVICE"	Provides more detailed interaction and guidance.

The system defaults to the novice interaction mode.

Confirmation prompts are short questions the system asks when it is not sure of your request or when there are multiple possible responses to your request. For example, the system may ask "**Phone, is that correct?**".

When You Say	The System
"CONFIRMATION PROMPTS OFF"	Makes a best guess from the command; you may still occasionally be asked to confirm settings.
"CONFIRMATION PROMPTS ON"	Clarifies your voice command with a short question.

The system creates candidate lists when it has the same confidence level of several options based on your voice command. When turned on, you may be prompted with as many as four possibilities for clarification.

For example say, "1" after the tone to call John Doe at home or "2" after the tone to call Johnny Doe on mobile or "3" after the tone to call Jane Doe at home.

The same logic applies to media content. For example say: "1" after the tone to play John Doe or "2" after the tone to play Johnny Doe or "3" after the tone to play Jane Doe.

When You Say	The System
"MEDIA CANDIDATE LISTS OFF"	Makes a best guess from the media candidate list; you may still occasionally be asked questions.
"MEDIA CANDIDATE LISTS ON"	Clarifies your voice command for media candidates.
"PHONE CANDIDATE LISTS OFF"	Makes a best guess from the phone candidate list; you may still occasionally be asked questions.
"PHONE CANDIDATE LISTS ON"	Clarifies your voice command for phone candidates.

## Changing the Voice Settings Using the Multifunctional Display

1. Press the **MENU** button.
2. Select SYNC-Settings.
3. Select Voice settings.

## USING SYNC™ WITH YOUR PHONE



Voice button



Receive call



End call



Volume up



Volume down

Hands-free calling is one of the main features of SYNC. While the system supports a variety of features, many are dependent on your cell phone's functionality. At a minimum, most cell phones with Bluetooth® wireless technology support the following functions:

- Dialing a number
- Answering an incoming call
- Ending a call
- Redialing
- Call waiting notification
- Join calls
- Using privacy mode
- Caller ID

Other features such as text messaging using Bluetooth and automatic phonebook download are phone-dependent features. To check your phone's compatibility, refer to your phone's user guide and visit [www.fordsync.com](http://www.fordsync.com).

**Note:** When using the system for the first time, no phone is connected to the system.

## Pairing a Phone for the First Time

**Note:** SYNC can support downloading up to approximately 1000 entries per Bluetooth-enabled cell phone.

**Note:** When the phonebook is downloaded from a cell phone onto the SYNC system, on most phones it will only download the contacts stored in the phone's memory and not those stored on the SIM card. Some phones support the transfer of contacts from the SIM card to the SYNC system.

**Note:** Make sure the radio is turned on.

**Note:** To scroll through the menus, press the up or down arrow buttons on your audio system.

**Note:** If your phone is already paired with another vehicle's SYNC system, before you pair your phone with a new vehicle, please make sure you delete the SYNC device name in your phone then search a new SYNC device in the new vehicle for pairing.

Wirelessly pairing your phone with SYNC allows you to make and receive hands-free calls.

1. Press the **PHONE** button. A message "No phones paired. please add a phone" appears.
2. Press the button mapped to **Add** on the information and entertainment display.
3. A six-digit PIN will be provided by SYNC.
4. Put your phone into Bluetooth mode. Refer to your phone's user guide if necessary.
5. When prompted on your phone's display, make sure the six-digit PIN is the same as the PIN provided by SYNC in the radio display. Some phones may require you to enter the PIN manually. The display indicates when the pairing is successful.

Depending on your phone's capability and your location, the system may prompt you with questions such as setting the current phone as the primary phone (the phone SYNC automatically tries to connect with first upon vehicle start-up), downloading your phone book, etc.

## Pairing Subsequent Phones

**Note:** Make sure radio is turned on.

**Note:** To scroll through the menus, press the up or down arrow buttons on your audio system.

1. Press the **PHONE** button.
2. Press the up or down arrow buttons until **BT devices** is shown and press OK.
3. Press the button mapped to **Add** on the information and entertainment display.
4. Put your phone into Bluetooth mode. Refer to your phone's user guide if necessary.
5. When prompted by your phone, make sure the six-digit PIN is the same as the PIN provided by SYNC in the radio display. Some phones may require you to enter the PIN manually.

The system then prompts with questions such as if you would like to set the current phone as the primary phone (the phone SYNC automatically tries to connect with first upon vehicle start-up), download your phone book, etc.

## Connecting a previously paired phone with SYNC™

If you disconnect your phone with SYNC or leave the vehicle, you do not need to pair your phone with SYNC again.

**Note:** Make sure your phone's bluetooth is on.

Press the **PHONE** button and system will search paired Bluetooth device.

If there are several Bluetooth devices in vehicle, system will try to connect to the primary phone. If the primary phone is not available in the vehicle, SYNC will connect to the available paired phone after searching is finished.

**Note:** In some phones an access confirmation will pop up in phone's screen, "YES" always needs to be selected to allow SYNC to automatically connect and transfer phonebook and Bluetooth text messages.

## Changing the active phone

**Note:** Phones must be paired to the system before they can be made active.

1. Press the **PHONE** button.
2. Press the up or down arrow buttons until **BT devices** is shown and press OK.
3. Press the up or down arrow buttons to select the desired bluetooth device.
4. Press the button mapped to **Conn.** on the information and entertainment display.

## Downloading phonebook

**Note:** When the phonebook is downloaded from a cell phone onto the SYNC system, on most phones it will only download the contacts stored in the phone's memory and not those stored on the SIM card. Some phones support the transfer of contacts from the SIM card to the SYNC system.

SYNC can support downloading up to approximately 1000 entries per Bluetooth-enabled cell phone.

1. Press **PHONE** button.
2. Press the up or down arrow buttons until **Phone settings** is shown and press OK.

3. Press the up or down arrow buttons until **Phonebook pref.** is shown and press OK.
4. Press the up or down arrow buttons until **Download now** is shown and press OK.
5. Press OK button again to confirm download.

## Phone Voice Commands

### Overview

The overview below shows the available voice commands. The following lists will give further information about the complete command menu in selected examples

Press VOICE BUTTON and when prompted, say any of the following commands
"READ MESSAGE"
"CALL" / "DIAL"
"CALL <name>"
"CALL <name> AT HOME"
"CALL <name> ON MOBILE/CELL"
"CALL <name> ON OTHER"
"CALL <name> AT WORK/IN OFFICE"
"MAIN MENU"

### Phone book commands

Press the **VOICE** button and say "CALL/DIAL" to call the contact.

When you ask SYNC to access a phone book name, number, etc., the requested information appears in the display to view.

"DIAL"
"Number <(0-9)>"
"DELETE"
"PLUS"
"POUND" / "HASH", (#)
"ASTERISK" / "STAR" (*)

# SYNC™

<b>"DIAL"</b>
"CLEAR" <sup>2</sup>
"123" (one-two-three). "121" (one-two-one), etc.

<sup>1</sup>Delete the last input digit or character.

<sup>2</sup>Delete all entered digits or characters.

**Note:** To exit dial mode, press and hold the **PHONE** button or press **MENU** to go to the Phone menu.

**Note:** "CALL" command is used to call a phonebook contact and cannot be used to enter the phone number.

**Note:** "DIAL" command is used to call by entering a number and cannot be used for a phonebook contact.

## Commands used when in a call

<b>Press VOICE BUTTON and when prompted, say any of the following command</b>
"GO TO PRIVACY" / "GO TO HANDS FREE"
"HOLD CALL ON" / "HOLD CALL OFF"
"JOIN CALLS"
"MUTE CALL ON"
"UNMUTE CALL"

## Making a call

### Dialing a number using voice command

Press the **VOICE BUTTON** and when prompted say:

Type 1

1. "CALL <name> MOBILE/HOME/WORK/OFFICE/OTHER".
2. If there are several numbers listed under the desired category, choose the line number by saying "LINE1/2/3".

Type 2

1. "CALL <name>".
2. System will feedback "**CALL <name>, Is that correct?**"
3. Say "YES".
4. System will ask "**CALL <name> mobile/home/work/office/other, Is that correct?**"
5. Based on the numbers shown in the display, say "MOBILE/HOME/WORK/OFFICE/OTHER".
6. If there are several numbers listed under the desired category, choose the line number by saying "LINE1/2/3".

Type 3

1. "DIAL".
2. System will ask "**Start to say a phone number**".
3. You can say the desired number <0-9>.
4. System will repeat the number you have said.
5. Say "DIAL".

### Dialing a number using the address book

1. Press **PHONE** button.
2. Press the up or down arrow buttons until **Phonebook** is shown.
3. Press OK button.
4. Press the up or down arrow buttons to select the desired phone number.

**Note:** *Press and hold the up or down arrow buttons to search forwards or backwards within the phonebook.*

5. Press OK button to dial the selected phone number.

### Dialing a number using the telephone keypad (Where fitted to your vehicle)

If you have an audio unit with a telephone keypad (buttons 0-9, \* and #):

1. Press the **PHONE** button.
2. Press the up or down arrow buttons until **Dial a number** is shown.
3. Press OK button.
4. Dial the number using the telephone keypad on the audio unit.
5. Press OK button.

**Note:** *Press and hold '0' to enter a + digit.*

**Note:** *It is necessary to choose the SIM card in the cell phone when using a dual SIM cell phone.*

### Ending a call

Press the **END CALL** button to end a call.

### Redialing a number

1. Press the **PHONE** button.
2. Press the up or down arrow buttons until **Call history** is shown.
3. Press OK button.

**Note:** *If the active phone does not provide a call out list, the last outgoing call number/entry can be redialed.*

4. Press the up or down arrow buttons to select the desired call history and press OK button.
5. Press the up or down arrow buttons to select the desired phone number and press OK button.

### Redialing the last dialed number

Press the **PHONE** button to go to PHONE menu, and then press the **PHONE** button again to redial the last dialed number.

### Using the Speed Dial Feature

#### Set speed dial

1. Press the **PHONE** button.
2. Select **Phonebook** or **Call history**.
3. Press the up or down arrow buttons to locate the desired phone number you want to set as a speed dial.
4. Then press and hold one of the number keys "0-9" on the control panel until the confirmation message "**Store to speed dial # <0-9>**" is shown.

#### Quick dialing

1. Press the **PHONE** button.
2. Press and hold the defined number key "0-9" on the control panel to make a call or

3. Press the up or down arrow buttons to select **Speed dial**.
4. Locate the desired phone number.
5. Press OK button.

## Receiving an incoming call

### Accepting an incoming call

Incoming calls can be accepted by pressing the **RECEIVE CALL** button, or by pressing the OK button.

### Rejecting an incoming call

Incoming calls can be rejected by pressing the **END CALL** button.

## Receiving a second incoming call

If there is an incoming call whilst there is an ongoing call, a beep will be heard and you will have the option to end the active call and to accept the incoming call.

### Accepting a call

Press the **RECEIVE CALL** or OK button to accept the second incoming call.

**Note:** *The active call will be placed on hold automatically.*

### Joining the calls

SYNC supports a maximum of three callers on a multi-party/conference call.

#### Using voice command:

After accepting the second incoming call, press the **VOICE BUTTON** and when prompted say "JOIN".

#### Using menu options:

1. Press the button mapped to **More** on the information and entertainment to select **Join Calls**.
2. Press OK button.

## Setting up a multi-party call

When you are in a call and want to invite another person to join the call, you can:

- Press the **VOICE BUTTON** and say "CALL <name> /MOBILE/HOME/WORK/OFFICE/OTHER" or say ""DIAL" to make a new call.
- Press the button mapped to **More** on the information and entertainment to select **Dial**, **Phone book** and **Call history** to make a new call

And then press the **VOICE BUTTON** and say "JOIN".

## Rejecting a call

Press the **END CALL** button to reject the second incoming call.

## Muting and Unmuting the microphone

### Using voice command:

Press the **VOICE BUTTON** and when prompted say "MUTE CALL ON" / "UNMUTE CALL".

### Using menu options:

Press the button mapped to **Mic off** on the information and entertainment display to mute/unmute the microphone.

## Switching between speaker phone and hands-free mode

Privacy mode can be activated from a hands-free mode while in an active call.

### Using voice command:

Press the **VOICE BUTTON** and when prompted say "GO TO PRIVACY".

### Using menu options:

Press the button mapped to **Private** on the information and entertainment display to switch between privacy and hands-free mode.



## Ongoing calls while entering and exiting the vehicle

**Note:** Make sure the radio and Bluetooth® mode are turned on.

SYNC provides uninterrupted connections while entering or exiting your vehicle.

When entering the vehicle with an ongoing call, the user needs to open the door, then turn on the ignition, SYNC will search and connect the phone automatically (if it has been paired previously).

When exiting the vehicle with an ongoing call, the user needs to turn off the ignition, then open the door, the call will be automatically transferred from SYNC to the phone.

## Text Messaging

### WARNING



Local laws may prohibit some or all of the text messaging functions while driving. Check your local road rules before using these functions.

**Note:** This is a phone-dependent feature. If your phone is compatible, SYNC allows you to receive, send, download and delete text messages.

**Note:** Each text message will be sent with the signature "This message was sent from my Ford."

SYNC allows you to receive, send, download and delete text messages. The system can also read incoming text messages so that driving the vehicle is not disturbed.

## Receiving a Text Message

When a new message arrives, an audible tone sounds and the display indicates you have a new message. You have these options:

## Using voice command:

Wait till the new message notification pop-up disappears, and then press the **VOICE BUTTON**, wait for the prompt and say "READ TEXT MESSAGE" to have SYNC read the message to you.

## Using menu options:

Press the button mapped to **View** or **Listen** on the information and entertainment display to view or listen the new text message.

## Reply to a message

1. Press **PHONE** button.
2. Press the up or down arrow buttons until **Text messaging** is shown and press OK button.
3. Press the up or down arrow buttons to select the desired text messages and press OK button.
4. Press the button mapped to **More** on the information and entertainment display.
5. Press the up or down arrow buttons to select **Reply to sender** and press OK button.
6. Press the up or down arrow buttons to select from the desired pre-defined text messages and press OK button.
7. Press the button mapped to **Send**.
8. Press the button mapped to **Yes** to confirm.

## Forward a message

1. Press **PHONE** button.
2. Press the up or down arrow buttons until **Text messaging** is shown and press OK button.

3. Press the up or down arrow buttons to select the desired text message and press OK button or press the button mapped to **View** on the information and entertainment display.
4. Press the button mapped to **More** on the information and entertainment display.
5. Press the up or down arrow buttons to select **Forward msg** and press OK button.
6. Press the up or down arrow buttons to select the desired recipient from Phonebook/Call history/Phone number.
7. Press the button mapped to **Send** when desired recipient is selected.
8. Press the button mapped to **Yes** to confirm.

## Predefined text messages

**Note:** Predefined text messages are from SYNC system and not from the phone.

- Can't talk now
- Call you later
- Heavy traffic :-(
- See u in 10 min.
- See u in 20 min.
- Yes
- No
- Thanks!
- Too funny :-)
- Miss you
- I love you
- Send directions
- Call me
- Where are you?
- Why?

## SYNC™ APPLICATIONS AND SERVICES (If Equipped)

### Mobile Apps (Ford Applink™)

The system enables voice and manual control of Ford Applink™ enabled smartphone apps. Once an app is running through Ford Applink™, you can control the main features of the app through voice commands and manual controls.

**Note:** You must pair and connect your smartphone to SYNC to access Ford Applink™.

**Note:** iPhone users need to connect the phone to the USB port with an Apple authorized cable.

**Note:** Android users need to connect the phone to SYNC using Bluetooth.

**Note:** For information on available apps, supported smartphone devices and troubleshooting tips please visit the regional Ford website [www.fordsync.com](http://www.fordsync.com)

**Note:** Make sure you have an active account for the app that you have downloaded. Some apps will work automatically with no setup. Other apps will want you to configure your personal settings and personalize your experience by creating stations or favourites. We recommend you do this at home or outside of your vehicle.

### To Access Using the SYNC Menu

1. Press the **MENU** button to access the main menu.
2. Scroll to **SYNC Applications** and press **OK** to access the menu.
3. Scroll to **Mobile Apps**, press **OK** to confirm and access the **Mobile Apps** menu.
4. Scroll through the list of available applications and select a particular app or select **Find New Apps**.

**Note:** If a Ford Applink™ compatible app cannot be found, please make sure the required app is running on the mobile device.

## Accessing an App's Menu

- Once an app is running through SYNC, press the right arrow button to access the app menu.
- You can access various app features from here, for example thumbs up and thumbs down.
- Press the left arrow button to exit the app menu.

## To Access Using Voice Commands

1. Push the **VOICE BUTTON**.
2. Say the name of the application after the tone.
3. The application will start. While an app is running through SYNC, you can press the **voice button** and speak commands specific to the app, for example "Play My Favorite". If you don't know what kind of features are available in your app, say "<the name of an app> HELP" to discover the available voice commands.

The following voice commands are always available:

When You Say	The System
"MOBILE APPS"	prompts you to say the name of an app to start it on SYNC.
"LIST MOBILE APPS"	lists all of the currently available Mobile Apps.
"FIND NEW APPS"	searches your connected mobile device for SYNC-compatible mobile apps.
"<the name of an app>"	starts the mobile app on SYNC.
"<the name of an app> HELP"	lists the available voice commands for the specified app.

## App Permissions

App permissions are organized by groups. You can grant these group permissions individually. You can change a permission group status any time when not driving, by using the settings menu.

When you launch an app using SYNC, the system may ask you to grant certain permissions, for example:

- To allow your vehicle to provide vehicle information to the app including, but not limited to: Fuel level, Fuel economy, Engine RPMs, Odometer, VIN, External Temperature, Fuel Consumption, Tire pressure.
- To allow your vehicle to provide driving characteristic information, including, but not limited to: MyKey, Seat belt status, Gear Position.

- To allow your vehicle to provide location information, including: GPS and speed.
- To allow the app to send push notifications using the vehicle display and voice capabilities while running in a background state. Push notification may be particularly useful for news or location based apps.

**Note:** *You will only need to grant permissions the first time you use an app with SYNC.*

**Note:** *Ford is not responsible or liable for any damages relating to usage of an app, or dissemination of any vehicle data that you approve Ford to provide to an app.*

**Note:** *Ford has no control over, and assumes no responsibility for, the privacy policies or practices of third party apps. You should inform yourself of the terms and conditions and privacy policies applicable to each app you use.*

## Enabling and Disabling App Permissions Using the SYNC Menu

1. Press the **MENU** button to access the main menu.
2. Scroll to **SYNC Applications** and press **OK** to access the menu.
3. Scroll to **Mobile Apps** and press **OK** to access the menu.
4. Scroll to **App Settings** and press **OK** to access the menu.
5. Select the specific app or All Apps.
6. Extra permissions and features available for each app will be listed in the menu. Check or uncheck the box to enable or disable the permission or feature as desired.

## Enabling SYNC Mobile Apps

In order to enable mobile apps, SYNC requires user consent to send and receive app authorization information and updates using the data plan associated with the connected device.

Data is sent to Ford in the United States through the connected device. The information is encrypted and includes your VIN, SYNC module number, anonymous usage statistics and debugging information. Updates may take place automatically.

**Note:** *You must enable mobile apps for each connected device the first time you select a mobile app using the system.*

**Note:** *Standard data rates will apply. Ford is not responsible for any additional charges you may receive from your service provider, when your vehicle sends or receives data through the connected device. This includes any additional charges incurred due to driving in areas when roaming out of a home network.*

## App Status

You can view the current status of an app in the settings menu.

There are three possible statuses:

- **Update Needed** - The system has detected a new app requiring authorization or a general permissions update is required.
- **Up-To-Date** - No update is required.
- **Updating...** - The system is trying to receive an update.

If an update is required and you want to manually request this update, for example when in a Wi-Fi hotspot, select **Request Update** in the settings menu.

You can disable automatic updates by selecting **Disable Updates** in the settings menu. Doing so will also disable the use of Mobile Apps on SYNC.

## Emergency Assistance

### WARNINGS



For this feature to work, your cell phone must be Bluetooth capable and compatible with SYNC.



Always place your cell phone in a secure location inside your vehicle so it does not become a projectile or get damaged in a crash. Failure to do so may cause serious injury to someone or damage the phone which could prevent Emergency Assistance from working correctly.



Unless the Emergency Assistance setting is set to on prior to a crash, the system will not attempt to place an emergency call which could delay response time, potentially increasing the risk of serious injury or death.



Do not wait for Emergency Assistance to make an emergency call if you can do it yourself. Dial emergency services immediately to avoid delayed response time. If you do not hear Emergency Assistance within five seconds after the crash, the system or cell phone may be damaged or nonfunctional.

**Note:** Before setting the feature on, please read the important notice about the Ford SYNC Emergency Assistance feature and the Emergency Assistance privacy notice later in this section for important information.

**Note:** When you turn Emergency Assistance on or off, the setting will apply for all paired cell phones. If you have turned Emergency Assistance off and a previously paired phone connects when you switch the ignition on, either a voice message plays, a display message or icon is shown or both.

**Note:** Every cell phone operates differently. While SYNC Emergency Assistance works with most cell phones. Some cell phones may experience difficulties using this feature.

**Note:** For important information regarding airbag deployment. See **Owner Manual**.

**Note:** Ford is not the provider of the emergency services contacted by SYNC when an emergency call is initiated. Ford does not accept any liability in relation to the provision, quality or timeliness of those services.

In the event of a crash which deploys an airbag or activates the fuel pump shut-off, the system may be able to contact emergency services (including call center) through a paired and connected cell phone. For more information about SYNC and Emergency Assistance visit your regional Ford website **www.fordsync.com**

### Setting Emergency Assistance On

1. Press the **MENU** button to enter the main menu.
2. Scroll to **SYNC Applications** and press **OK** to access the menu.
3. Scroll to **Emergency Assistance**.
4. Press **OK** to confirm and enter the Emergency Assistance menu.
5. Scroll through and highlight the **On** or **Off** selection.
6. Press **OK** to confirm the selection.

## Display options:

- In the case where **On** is selected, **Emergency Assistance On** appears in the display as confirmation.
- In the case where **Off** is selected an option appears which allows you to set a voice reminder.
- **Emergency Assistance Off Voice reminder on** provides a display and voice reminder when the cell phone connects and your vehicle starts.
- **Emergency Assistance Off Voice reminder off** provides a display reminder only without a voice reminder when the cell phone connects and your vehicle starts.

## To Make Sure That Emergency Assistance Works Correctly

- SYNC must be powered and work correctly at the time of the crash and during feature activation and use.
- The Emergency Assistance feature must be set to on prior to the incident.
- You must have a cell phone connected to SYNC.
- It is necessary to have a valid and registered SIM card with credit in order to place and maintain an emergency call.
- A connected cell phone must have the ability to make and maintain an outgoing call at the time of the incident.
- A connected cell phone must have adequate network coverage, battery power and signal strength.
- Your vehicle must have battery power and be located in a region where SYNC Emergency Assistance can call the emergency services. See your regional Ford website for details at **[www.fordsync.com](http://www.fordsync.com)**

## In the Event of a Crash

**Note:** *Not every crash will deploy an airbag or activate the fuel pump shut-off (the triggers for Emergency Assistance). However, if Emergency Assistance is triggered, SYNC tries to contact the emergency services. If a connected cell phone is damaged or loses connection to SYNC during a crash, SYNC searches for and tries to connect to any available previously paired cell phone and will attempt to make an emergency call.*

### The Emergency Assistance Call:

- SYNC provides a short window of time (approximately 10 seconds) to cancel the call. If the call is not cancelled SYNC will attempt to dial emergency services.
- SYNC speaks the following or a similar message to vehicle occupants if Emergency Assistance is triggered: "SYNC will attempt to make an emergency call. To cancel the call, please choose cancel from the screen or press the hang up button".
- If the call has not been cancelled and a successful call is made, an introductory message is played first for the emergency operator, followed by hands-free communication between your vehicle occupant and the operator.

### During an Emergency Assistance call:

- Emergency Assistance alerts the emergency operator of the crash and delivers an introductory message, which may include your vehicle's GPS coordinates.
- After the delivery of the introductory message the voice line will open so that you can have a hands-free conversation with the emergency operator. SYNC will say "line open" or similar at the start of hands-free communication.
- Once connected, be prepared to provide your name, phone number and location information to assist emergency services.
- You modified any hardware or software of related modules, such as SYNC, Restraint System, GPS, Message Gateway, etc.
- You are in a location where the SYNC Emergency Assistance call cannot be placed. See your regional Ford website for details at **www.fordsync.com**

## Important Information about Ford SYNC™ Emergency Assistance

Emergency Assistance may not call emergency services in some regions or markets. See your regional Ford website for latest details at **www.fordsync.com**

## Emergency Assistance Privacy Notice

When you turn Emergency Assistance on, it may disclose to emergency services that your vehicle has been in a crash involving the deployment of an airbag or activation of the fuel pump shut-off. This feature has the capability to disclose your location information to the emergency operator or other details about your vehicle or crash to assist emergency operator to provide the most appropriate emergency services.

If you do not want to disclose this information, do not turn the feature on.

## USING SYNC™ WITH YOUR MEDIA PLAYER

You can access and play music from your digital music player over the vehicle's speaker system using the system's media menu or voice commands. You can also sort and play your music by specific categories such as artists, albums, etc.

SYNC is capable of hosting most digital media players in the market including: iPod®, "Plays from device" players, and most USB drives. SYNC also supports audio formats such as MP3, WMA, WAV and ACC.

**Note:** Failure to cancel the call as described above will result in SYNC dialing emergency services.

**Note:** While information is being provided to the emergency operator you will hear the following or similar message "Please stand by while important information is being delivered to the emergency operator".

**Note:** The emergency operator may also receive information from the mobile network such as phone number, and cell phone carrier name independent from the SYNC Emergency Assistance system.

Emergency Assistance may not work if:

- Your cell phone or Emergency Assistance hardware has been damaged in a crash.
- Your vehicle's battery or the SYNC system has no power.
- Your phone is thrown from your vehicle during a crash.
- You do not have a valid and registered SIM card with credit.
- You do not have a connected cell phone with the ability to make and maintain an outgoing call, adequate network coverage, battery power and signal strength.

## Connecting Your Digital Media Player to SYNC™ via the USB Port

With the radio and digital media player ON, plug the device into the USB port.

When first plugged in, SYNC will index all available music content and prepare the voice commands. This can take from a few seconds to a few minutes depending on the amount of content on your device.

## Using Voice Command:

1. Press the **VOICE BUTTON** and when prompted, say "USB".
2. You can now play music by saying any of the following appropriate voice commands.

<b>"USB"</b>	
"PLAY ALL"	"PLAY ARTIST <name>" <sup>1,2</sup>
"PLAY GENRE <name>" <sup>1,2</sup>	"PLAY ALBUM <name>" <sup>1,2</sup>
"PLAY TRACK <name>" <sup>1,2</sup>	"PLAY PLAYLIST <name>" <sup>1,2</sup>

<sup>1</sup> <name> is a dynamic listing, meaning that it could be the name of any desired group, artist, etc.

<sup>2</sup> Voice commands which are not available until indexing is complete.

When the music is playing, you also can press the **VOICE BUTTON** and say one of the following appropriate voice commands.

<b>"USB"</b>	
"WHAT IS PLAYING" / "WHAT IS THIS"	"REPEAT ONE ON" / "REPEAT ONE"
"PLAY"	"REPEAT OFF"
"PAUSE"	"SIMILAR MUSIC"
"PLAY NEXT TRACK" / "NEXT TRACK"	"PLAY PREVIOUS TRACK" / "PREVIOUS TRACK"
"SEARCH ALL TRACK"	"SEARCH PLAYLIST <name>" <sup>1,2</sup>
"SEARCH ALBUM <name>" <sup>1,2</sup>	"SEARCH GENRE <name>" <sup>1,2</sup>



"USB"	
"SEARCH ARTIST <name>" <sup>1,2</sup>	"SHUFFLE ALL ON"
"SHUFFLE OFF"	

<sup>1</sup> <name> is a dynamic listing, meaning that it could be the name of any desired group, artist, etc.

<sup>2</sup> Voice commands which are not available until indexing is complete.

**Note:** At any time, you may press the **VOICE BUTTON** and say "HELP" for assistance.

### Voice Command Guide

**Note:** Only support for USB device.

Voice Command Guide	
"WHAT IS PLAYING" / "WHAT IS THIS"	At any time when a track is playing, you can press the voice control button and ask the system "What's playing?" / "What is this?" The system reads the metadata tags (if populated) of the playing track to you.
"SEARCH GENRE" or "PLAY GENRE"	The system searches all the data from your indexed music and, if available, begins to play the chosen type of music. You can only play genres of music which are present in the GENRE metadata tags that you have on your digital media player.
"SIMILAR MUSIC"	The system compiles a playlist and then plays similar music to what is currently playing from the USB port using indexed metadata information.
"SEARCH", "PLAY", "ARTIST", "TRACK", "ALBUM"	The system searches for a specific artist, track or album from the music indexed through the USB port.

### Using Menu Options:

1. Press the **AUX** button on the front control panel until the USB source is displayed.
2. Press the button mapped to **Menu** on the multi-function display.
3. Select **USB Song Library** and your music is automatically organized by playlists, songs, artists, albums, and genres.

## Connecting Your Digital Media Player to SYNC™ via the AUX Port

**Note:** At any time, you may press the **VOICE BUTTON** and say "HELP" for assistance.

With the radio and digital media player ON, plug the device into the AUX port.

Press the **VOICE BUTTON** and when prompted, say "LINE IN".

## Connecting Your Digital Media Player to SYNC™ via Bluetooth®

SYNC allows users to stream music from their Bluetooth-enabled cell phone or player and play it through the SYNC audio system in the vehicle.

Pair your phone with SYNC. See **Using SYNC™ With Your Phone** (page 192).

Press the **VOICE BUTTON** and when prompted, say "BLUETOOTH AUDIO".

PLAY music by saying "PLAY" and SYNC will prompt "PLAY ALL", then start music playing.

You also can press the **VOICE BUTTON** and say one of the following appropriate voice commands, when the music is playing.

"BLUETOOTH AUDIO"	
"PLAY"	"PAUSE"
"PLAY NEXT TRACK" / "NEXT TRACK"	"PLAY PREVIOUS TRACK" / "PREVIOUS TRACK"
"HELP"	"CANCEL"

## SYNC™ TROUBLESHOOTING

Your SYNC system is easy to use. However, should questions arise, please refer to the tables below.

Use the website at any time to check your phone's compatibility. Visit [www.fordsync.com](http://www.fordsync.com) for more information.

Phone Issues		
Issue	Possible Cause(s)	Possible Solution(s)
A lot of background noise during a phone call.	The audio control settings on your phone may be affecting SYNC performance.	Review your phone's user guide regarding audio adjustments.
During a call, I can hear the other person but they cannot hear me.	Possible phone malfunction.	Try turning off the device, resetting the device, removing the device's battery, then trying again.
SYNC is not able to download my phonebook.	<ul style="list-style-type: none"> <li>· This is a phone-dependent feature.</li> <li>· Possible phone malfunction.</li> </ul>	<ul style="list-style-type: none"> <li>· Go to the website to review your phone's compatibility.</li> <li>· Try turning off the device, resetting the device or removing the device's battery, then trying again.</li> <li>· Try "pushing" your phonebook contacts to SYNC by using the <b>Download now</b> feature.</li> </ul>
The system says "Phonebook downloaded" but my phonebook in SYNC is empty or is missing contacts.	Limitations on your phone's capability.	<ul style="list-style-type: none"> <li>· Try "pushing" your phonebook contacts to SYNC by using the <b>Download now</b> feature.</li> <li>· If the missing contacts are stored on your SIM card, try moving them to the device memory.</li> <li>· Remove any pictures or special ring tones associated with the missing contact.</li> </ul>
I'm having trouble connecting my phone to SYNC.	<ul style="list-style-type: none"> <li>· This is a phone-dependent feature.</li> <li>· Possible phone malfunction.</li> </ul>	<ul style="list-style-type: none"> <li>· Go to the website to review your phone's compatibility.</li> <li>· Try turning off the device, resetting the device or removing the device's battery, then trying again.</li> <li>· Try deleting your device from SYNC, deleting SYNC from your device and trying again.</li> </ul>

<b>Phone Issues</b>		
<b>Issue</b>	<b>Possible Cause(s)</b>	<b>Possible Solution(s)</b>
		<ul style="list-style-type: none"> <li>· Check the security and "auto accept/prompt always" settings relative to the SYNC Bluetooth connection on your phone.</li> <li>· Update your device's firmware.</li> <li>· Turn off the Auto phonebook download setting.</li> </ul>
Text messaging is not working on SYNC.	<ul style="list-style-type: none"> <li>· This is a phone-dependent feature.</li> <li>· Possible phone malfunction.</li> </ul>	<ul style="list-style-type: none"> <li>· Go to the website to review your phone's compatibility.</li> <li>· Try turning off the device, resetting the device or removing the device's battery, then trying again.</li> </ul>
System can not find my contacts.	<ul style="list-style-type: none"> <li>· This is a phone-dependent feature.</li> <li>· Possible phone malfunction.</li> </ul>	<ul style="list-style-type: none"> <li>· Check whether your phonebook has been downloaded into SYNC properly and successfully.</li> <li>· Do not separate First name and Last name when creating new contacts. Otherwise users need to speak the contact name as the order shown on SYNC screen.</li> <li>· For some contact names in SYNC phonebook, if SAYING the whole name is not successfully recognized, please try to find the contact in SYNC and press the "hear it", and then say the contact according to what SYNC said.</li> <li>· If users add a new contact into the paired phone, but it is not shown in SYNC phonebook, please redownload the phonebook into SYNC.</li> </ul>

# SYNC™

<b>Phone Issues</b>		
<b>Issue</b>	<b>Possible Cause(s)</b>	<b>Possible Solution(s)</b>
		· If all contacts in SYNC phonebook can't be accessed via voice commands, please double check whether your phonebook has been downloaded correctly, and then check contact names are the same as what you said. If this does not work, please <b>reset</b> the system and try again. If still does not work, please switch off the audio system and restart it.
System can not recognise the phone number I said.	You may be speaking too soon or too slowly.	For a higher successful recognition rate, try saying the phone number in several groups instead of speaking out at one time. For example: for a 11 digit phone number, say the first 3 digits, wait for SYNC confirmation, then say the next 4 digits, wait for SYNC confirmation, and then say the last 4 digits.

<b>USB/Media Issues</b>		
<b>Issue</b>	<b>Possible Cause(s)</b>	<b>Possible Solution(s)</b>
I'm having trouble connecting my device.	Possible device malfunction.	· Try turning off the device, resetting the device, removing the device's battery, then trying again. · Make sure you are using the manufacturer's cable. · Make sure the USB cable is properly inserted into the device and the vehicle's USB port.

# SYNC™

<b>USB/Media Issues</b>		
<b>Issue</b>	<b>Possible Cause(s)</b>	<b>Possible Solution(s)</b>
		<ul style="list-style-type: none"> <li>· Make sure that the device does not have an auto-install program or active security settings.</li> </ul>
SYNC does not recognize my device when I turn on the vehicle.	This is a device limitation.	Make sure you are not leaving the device in your vehicle during very hot or cold temperatures.
Bluetooth audio does not stream.	This is a phone-dependent feature. The device is not connected.	Make sure the device is connected to SYNC and that you have pressed play on your device.
SYNC does not recognize music that is on my device.	<ul style="list-style-type: none"> <li>· Your music files may not contain the proper artist, song title, album or genre information.</li> <li>· The file may be corrupted.</li> <li>· The song may have copyright protection which does not allow it to play.</li> </ul>	<ul style="list-style-type: none"> <li>· Make sure that all song details are populated.</li> <li>· Some devices require you to change the USB settings from mass storage to MTP class.</li> </ul>
SYNC is not playing the album I think I have.	<ul style="list-style-type: none"> <li>· You may be using the wrong voice commands.</li> <li>· You may not be saying the name exactly as it is saved.</li> <li>· The system may not be "reading" the name the same way you are saying it.</li> </ul>	<ul style="list-style-type: none"> <li>· Try using the proper name listed on your media player. For instance, if the album is titled "Star Wars, the motion picture soundtrack," saying "Play album Star Wars" won't work, but saying "Play album Star Wars the motion picture soundtrack" will work.</li> <li>· MP3 files, normally have four main attributes in the mp3's ID3 tag field: Title, Artist, Album and Genre. Please note "Title" may not be the same as the mp3 file's name.</li> </ul>

# SYNC™

<b>USB/Media Issues</b>		
<b>Issue</b>	<b>Possible Cause(s)</b>	<b>Possible Solution(s)</b>
		· The voice commands for playing specified artist/album/genre/title are effective only for USB devices. If your device connected to SYNC via AUX or bluetooth, these voice commands are not effective.
All songs can not be played by voice commands.	Possible device malfunction.	Try resetting the SYNC system, then try again.

<b>Voice Command Issues</b>		
<b>Issue</b>	<b>Possible Cause(s)</b>	<b>Possible Solution(s)</b>
System does not respond to my voice.	<ul style="list-style-type: none"> <li>· You may be using the wrong voice commands.</li> <li>· You may be speaking too soon or at the wrong time.</li> </ul>	<ul style="list-style-type: none"> <li>· This could be due to the ambient noise inside the vehicle. Make sure that other passengers in the vehicle are not speaking at the same time that the system is listening. Also, extraneous sounds, like wind noise, could interfere with the system recognizing voice commands.</li> <li>· You might be speaking too soon or speaking when the system isn't listening (for example, during a prompt). Make sure the system is in listening state by verifying that the icon "Listening" is in the display before saying a command to the system.</li> </ul>

# SYNC™

Voice Command Issues		
Issue	Possible Cause(s)	Possible Solution(s)
		<ul style="list-style-type: none"> <li>· Be aware of the system's sensitivities; yelling or speaking the voice commands too slowly does not help. Remember to speak the voice commands with a normal smooth, steady and confident voice.</li> </ul>
System could not hear me.	You may not be audible to the system.	Speak the voice commands clearly towards the microphone.
SYNC does not understand what I am saying.	<ul style="list-style-type: none"> <li>· You may be using the wrong voice commands.</li> <li>· You may be speaking too soon or at the wrong time.</li> </ul>	<ul style="list-style-type: none"> <li>· Review the phone voice commands and the media voice commands. See <b>Using SYNC™ With Your Phone</b> (page 192). See <b>Using SYNC™ With Your Media Player</b> (page 205).</li> </ul>
SYNC does not understand the name of a song or artist.	<ul style="list-style-type: none"> <li>· You may be using the wrong voice commands.</li> <li>· You may not be saying the name exactly as it is saved.</li> <li>· The system may not be "reading" the name the same way you are saying it.</li> </ul>	<ul style="list-style-type: none"> <li>· Review the media voice commands. See <b>Using SYNC™ With Your Media Player</b> (page 205).</li> <li>· Say the song or artist exactly as they are listed. If you say "Play Artist Prince" the system does not play music by Prince and the Revolution or Prince and the New Power Generation.</li> <li>· Make sure you are saying the complete title such as "California remix featuring Jennifer Nettles".</li> <li>· If the songs are saved in all CAPS, you have to spell them. LOLA requires you to say "L-O-L-A".</li> </ul>



# SYNC™

Voice Command Issues		
Issue	Possible Cause(s)	Possible Solution(s)
		<ul style="list-style-type: none"> <li>Do not use special characters in the title as the system does not recognize them.</li> </ul>
<p>SYNC does not understand or is calling the wrong contact when I want to make a call.</p>	<ul style="list-style-type: none"> <li>You may be using the wrong voice commands.</li> <li>You may not be saying the name exactly as it is saved.</li> <li>Contacts in your phonebook may be very short and similar, or they may contain special characters.</li> <li>Your phonebook contacts may be saved in CAPS.</li> </ul>	<ul style="list-style-type: none"> <li>Review the phone voice commands. See <b>Using SYNC™ With Your Phone</b> (page 192).</li> <li>Make sure you are saying the contacts exactly as they are listed. For example, if a contact is saved as Joe Wilson, say "Call Joe Wilson".</li> <li>The system works better if you list full names such as "Joe Wilson" rather than "Joe".</li> <li>Do not use special characters such as 123 or ICE as the system does not recognize them.</li> </ul>

AppLink issues		
Issue	Possible cause(s)	Possible solution(s)
<p>AppLink Mobile Applications: When I select "Find New Apps," SYNC does not find any applications.</p>	<p>An AppLink capable phone is not connected to SYNC.</p>	<p>Ensure you have a compatible smartphone; an Android with OS 2.3 or higher or an iPhone 3GS or newer with iOS 5.0 or higher. Additionally, ensure your phone is paired and connected to</p>

# SYNC™

<b>AppLink issues</b>		
<b>Issue</b>	<b>Possible cause(s)</b>	<b>Possible solution(s)</b>
		SYNC via Bluetooth in order to find AppLink-capable apps on your device. iPhone users must also connect to SYNC's USB port with an Apple USB cable.
My phone is connected, but I still cannot find any apps.	AppLink-enabled apps are not installed and running on your mobile device.	Ensure you have downloaded and installed the latest version of the app from your phone's app store. Ensure the app is running on your phone. Some apps require you to register or login on the app on the phone before using them with AppLink. Also, some may have a "Ford SYNC" setting, so check the app's settings or service menu on the phone.
My phone is connected, my app(s) are running, but I still cannot find any apps.	Sometime apps do not properly close and re-open their connection to SYNC, over ignition cycles, for example.	Closing and restarting apps may help SYNC find the application if you cannot discover it inside the vehicle. On an Android device, if apps have an "Exit" or "Quit" option, select that then restart the app. If the app does not have that option, you can also manually "Force Close" the app by going to the phone's settings menu, selecting 'Apps,' then finding the particular app and choosing 'Force stop.' Don't forget to restart the app afterwards, then select "Find New Apps" on SYNC.

# SYNC™

<b>Applink issues</b>		
<b>Issue</b>	<b>Possible cause(s)</b>	<b>Possible solution(s)</b>
		On an iPhone with iOS7+, to force close an app, double tap the home button then swipe up on the app to close it. Tap the home button again, then select the app again to restart it. After a few seconds, the app should then appear in SYNC's Mobile App's Menu.
My Android phone is connected, my app(s) are running, I restarted them, but I still cannot find any apps.	There is a bluetooth bug on some older versions of the Android OS that may cause apps that were found on your previous vehicle drive to not be found again if you have not turned off bluetooth.	Reset the Bluetooth on your phone by turning it off and then turning Bluetooth back on. If you are in your vehicle, SYNC should be able to automatically re-connect to your phone if you press the "Phone" button.

# SYNC™

<b>AppLink issues</b>		
<b>Issue</b>	<b>Possible cause(s)</b>	<b>Possible solution(s)</b>
My iPhone phone is connected, my app is running, I restarted the app but I still cannot find it on SYNC.	The USB connection to SYNC may need to be reset.	Unplug the USB cable from the phone, wait a moment, and plug the USB cable back in to the phone. After a few seconds, the app should appear in SYNC's Mobile Apps Menu. If not, "Force Close" the application and restart it.
I have an Android phone. I found and started my media app on SYNC, but there is no sound or the sound is very low.	The bluetooth volume on the phone may be low.	Try increasing the Bluetooth volume of the device by using the device's volume control buttons which are most often found on the side of the device.
I can only see some of the AppLink apps running on my phone listed in SYNC's Mobile Apps Menu.	Some Android devices have a limited number of bluetooth ports apps can use to connect. If you have more AppLink apps on your phone than the number of available Bluetooth ports, you will not see all of your apps listed in SYNC's mobile apps menu.	Force close or uninstall the apps you do not want SYNC to find. If the app has a "Ford SYNC" setting, disable that setting in the app's settings or service menu on the phone.





# Appendices

## ELECTROMAGNETIC COMPATIBILITY

### WARNINGS

 Your vehicle has been tested and certified to legislations relating to electromagnetic compatibility (72/245/EEC, UN ECE Regulation 10 or other applicable local requirements). It is your responsibility to make sure that any equipment you have fitted complies with applicable local legislations. Have any equipment fitted by an authorized dealer.

### WARNINGS

-  The radio frequency transmitter equipment (e.g. cellular telephones, amateur radio transmitters etc.) may only be fitted to your vehicle if they keep to the parameters shown in the table below. There are no special provisions or conditions for installations or use.
-  Do not mount any transceiver, microphones, speakers, or any other item in the deployment path of the airbag system.
-  Do not fasten antenna cables to original vehicle wiring, fuel pipes and brake pipes.
-  Keep antenna and power cables at least 4 inches (10 centimeters) from any electronic modules and airbags.

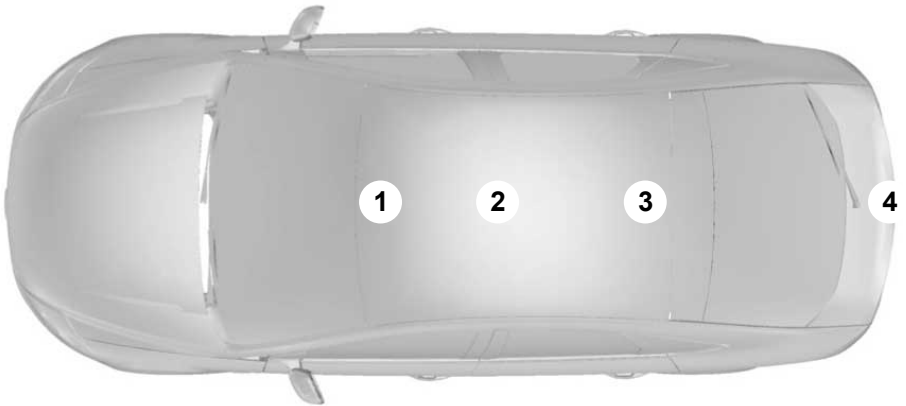

E85998

Frequency Band MHz	Maximum output power Watt (Peak RMS)	Antenna Positions
1 – 30	50 W	3, 4
30 – 54	50 W	1, 2, 3
68 – 87.5	50 W	1, 2, 3

# Appendices

<b>Frequency Band MHz</b>	<b>Maximum output power Watt ( Peak RMS)</b>	<b>Antenna Positions</b>
142 – 176	50 W	1, 2, 3
380 – 512	50 W	1, 2, 3
806 – 940	10 W	1, 2, 3
1200 – 1400	10 W	1, 2, 3
1710 – 1885	10 W	1, 2, 3
1885 – 2025	10 W	1, 2, 3

**Note:** After the installation of radio frequency transmitters, check for disturbances from and to all electrical equipment in your vehicle, both in the standby and transmit modes.

Check all electrical equipment:

- with the ignition ON
- with the engine running
- during a road test at various speeds.

Check that electromagnetic fields generated inside your vehicle cabin by the transmitter installed do not exceed applicable human exposure requirements.

## END USER LICENSE AGREEMENT

### SYNC® End User License Agreement (EULA)

- You have acquired a device ("DEVICE") that includes software licensed by Ford Motor Company and its affiliates ("FORD MOTOR COMPANY") from an affiliate of Microsoft Corporation ("MS"). Those installed software products of MS origin, as well as associated media, printed materials,

and "online" or electronic documentation ("MS SOFTWARE") are protected by international intellectual property laws and treaties. The MS SOFTWARE is licensed, not sold. All rights reserved.

- The MS SOFTWARE may interface with and/or communicate with, or may be later upgraded to interface with and/or communicate with additional software and/or systems provided by FORD MOTOR COMPANY. The additional software and systems of FORD MOTOR COMPANY origin, as well as associated media, printed materials, and "online" or electronic documentation ("FORD SOFTWARE") are protected by international intellectual property laws and treaties. The FORD SOFTWARE is licensed, not sold. All rights reserved.

# Appendices

- The MS SOFTWARE and/or FORD SOFTWARE may interface with and/or communicate with, or may be later upgraded to interface with and/or communicate with additional software and/or systems provided by third party software and service suppliers. The additional software and services of third party origin, as well as associated media, printed materials, and "online" or electronic documentation ("THIRD PARTY SOFTWARE") are protected by international intellectual property laws and treaties. The THIRD PARTY SOFTWARE is licensed, not sold. All rights reserved.
- The MS SOFTWARE, FORD SOFTWARE and THIRD PARTY SOFTWARE hereinafter collectively and individually will be referred to as "SOFTWARE".

**IF YOU DO NOT AGREE TO THIS END USER LICENSE AGREEMENT ("EULA") DO NOT USE THE DEVICE OR COPY THE SOFTWARE. ANY USE OF THE SOFTWARE, INCLUDING BUT NOT LIMITED TO USE ON THE DEVICE, WILL CONSTITUTE YOUR AGREEMENT TO THIS EULA (OR RATIFICATION OF ANY PREVIOUS CONSENT).**

**GRANT OF SOFTWARE LICENSE:** This EULA grants you the following license:

- You may use the SOFTWARE as installed on the DEVICE and as otherwise interfacing with systems and/or services provide by or through FORD MOTOR COMPANY or its third party software and service providers.
- ### Description of Other Rights and Limitations
- **Speech Recognition:** If the SOFTWARE includes speech recognition component(s), you should understand that speech recognition is an inherently statistical process and that recognition errors are inherent in the process. Neither FORD MOTOR COMPANY nor its suppliers shall be liable for any damages arising out of errors in the speech recognition process.
  - **Limitations on Reverse Engineering, Decompilation and Disassembly:** You may not reverse engineer, decompile, or disassemble nor permit others to reverse engineer, decompile or disassemble the SOFTWARE, except and only to the extent that such activity is expressly permitted by applicable law notwithstanding this limitation.
  - **Limitations on Distributing, Copying, Modifying and Creating Derivative Works:** You may not distribute, copy, make modifications to or create derivative works based on the SOFTWARE, except and only to the extent that such activity is expressly permitted by applicable law notwithstanding this limitation.
  - **Single EULA:** The end user documentation for the DEVICE and related systems and services may contain multiple EULAs, such as multiple translations and/or multiple media versions (e.g., in the user documentation and in the software). Even if you receive multiple EULAs, you are licensed to use only one (1) copy of the SOFTWARE.

# Appendices

---

- **SOFTWARE Transfer:** You may permanently transfer your rights under this EULA only as part of a sale or transfer of the DEVICE, provided you retain no copies, you transfer all of the SOFTWARE (including all component parts, the media and printed materials, any upgrades, and, if applicable, the Certificate(s) of Authenticity), and the recipient agrees to the terms of this EULA. If the SOFTWARE is an upgrade, any transfer must include all prior versions of the SOFTWARE.
- **Termination:** Without prejudice to any other rights, FORD MOTOR COMPANY or MS may terminate this EULA if you fail to comply with the terms and conditions of this EULA.
- **Security Updates/Digital Rights Management:** Content owners use the WMDRM technology included in your DEVICE to protect their intellectual property, included copyrighted content. Portions of the SOFTWARE on your DEVICE use WMDRM software to access WMDRM-protected content. If the WMDRM software fails to protect the content, content owners may ask Microsoft to revoke the SOFTWARE's ability to use WMDRM to play or copy protected content. This action does not affect unprotected content. When your DEVICE downloads licenses for protected content, you agree that Microsoft may include a revocation list with the licenses. Content owners may require you to upgrade the SOFTWARE on your DEVICE to access their content. If you decline an upgrade, you will not be able to access content that requires the upgrade.
- **Consent to Use of Data:** You agree that MS, Microsoft Corporation, FORD MOTOR COMPANY, third party software and systems suppliers, their affiliates and/or their designated agent may collect and use technical information gathered in any manner as part of product support services related to the SOFTWARE or related services. MS, Microsoft Corporation, FORD MOTOR COMPANY, third party software and services suppliers, their affiliates and/or their designated agent may use this information solely to improve their products or to provide customized services or technologies to you. MS, Microsoft Corporation, FORD MOTOR COMPANY, third party software and systems suppliers, their affiliates and/or their designated agent may disclose this information to others, but not in a form that personally identifies you.
- **Internet-Based Services Components:** The SOFTWARE may contain components that enable and facilitate the use of certain Internet-based services. You acknowledge and agree that MS, Microsoft Corporation, FORD MOTOR COMPANY, third party software and service suppliers, their affiliates and/or their designated agent may automatically check the version of the SOFTWARE and/or its components that you are utilizing and may provide upgrades or supplements to the SOFTWARE that may be automatically downloaded to your DEVICE.
- **Additional Software/Services:** The SOFTWARE may permit FORD MOTOR COMPANY, third party software and service suppliers, MS, Microsoft Corporation, their affiliates and/or their designated agent to provide or make available to you SOFTWARE updates,



# Appendices

---

supplements, add-on components, or Internet-based services components of the SOFTWARE after the date you obtain your initial copy of the SOFTWARE ("Supplemental Components").

If FORD MOTOR COMPANY or third party software and services suppliers provide or make available to you Supplemental Components and no other EULA terms are provided along with the Supplemental Components, then the terms of this EULA shall apply.

If MS, Microsoft Corporation, their affiliates and/or their designated agent make available Supplemental Components, and no other EULA terms are provided, then the terms of this EULA shall apply, except that the MS, Microsoft Corporation or affiliate entity providing the Supplemental Component(s) shall be the licensor of the Supplemental Component(s).

FORD MOTOR COMPANY, MS, Microsoft Corporation, their affiliates and/or their designated agent reserve the right to discontinue without liability any Internet-based services provided to you or made available to you through the use of the SOFTWARE.

- **Links to Third Party Sites:** The MS SOFTWARE may provide you with the ability to link to third party sites through the use of the SOFTWARE. The third party sites are not under the control of MS, Microsoft Corporation, their affiliates and/or their designated agent. Neither MS nor Microsoft Corporation nor their affiliates nor their designated agent are responsible for (i) the contents of any third party sites, any links contained in third party sites, or any changes or updates to third party sites, or (ii) webcasting or any other form of transmission received from any third party sites. If the SOFTWARE provides links to third party sites, those links are provided to you only as a convenience, and the inclusion of any link does not imply an endorsement of the third party site by MS, Microsoft Corporation, their affiliates and/or their designated agent.

- **Obligation to Drive Responsibly:** You recognize your obligation to drive responsibly and keep attention on the road. You will read and abide with the DEVICE operating instructions particularly as they pertain to safety and assumes any risk associated with the use of the DEVICE.

**UPGRADES AND RECOVERY MEDIA:** If the SOFTWARE is provided by FORD MOTOR COMPANY separate from the DEVICE on media such as a ROM chip, CD ROM disk(s) or via web download or other means, and is labeled "For Upgrade Purposes Only" or "For Recovery Purposes Only" you may install one (1) copy of such SOFTWARE onto the DEVICE as a replacement copy for the existing SOFTWARE, and use it in accordance with this EULA, including any additional EULA terms accompanying the upgrade SOFTWARE.

# Appendices

---

## **INTELLECTUAL PROPERTY RIGHTS:**

All title and intellectual property rights in and to the SOFTWARE (including but not limited to any images, photographs, animations, video, audio, music, text and "applets" incorporated into the SOFTWARE), the accompanying printed materials, and any copies of the SOFTWARE, are owned by MS, Microsoft Corporation, FORD MOTOR COMPANY, or their affiliates or suppliers. The SOFTWARE is licensed, not sold. You may not copy the printed materials accompanying the SOFTWARE. All title and intellectual property rights in and to the content which may be accessed through use of the SOFTWARE is the property of the respective content owner and may be protected by applicable copyright or other intellectual property laws and treaties. This EULA grants you no rights to use such content. All rights not specifically granted under this EULA are reserved by MS, Microsoft Corporation, FORD MOTOR COMPANY, third party software and service providers, their affiliates and suppliers. Use of any on-line services which may be accessed through the SOFTWARE may be governed by the respective terms of use relating to such services. If this SOFTWARE contains documentation that is provided only in electronic form, you may print one copy of such electronic documentation.

**EXPORT RESTRICTIONS:** You acknowledge that the SOFTWARE is subject to U.S. and European Union export jurisdiction. You agree to comply with all applicable international and national laws that apply to the SOFTWARE, including the U.S. Export Administration Regulations, as well as end-user, end-use and destination restrictions issued by U.S. and other governments. For additional information, see <http://www.microsoft.com/exporting/>.

**TRADEMARKS:** This EULA does not grant you any rights in connection with any trademarks or service marks of FORD MOTOR COMPANY, MS, Microsoft Corporation, third party software or service providers, their affiliates or suppliers.

**PRODUCT SUPPORT:** Product support for the SOFTWARE is not provided by MS, its parent corporation Microsoft Corporation, or their affiliates or subsidiaries. For product support, please refer to FORD MOTOR COMPANY instructions provided in the documentation for the DEVICE. Should you have any questions concerning this EULA, or if you desire to contact FORD MOTOR COMPANY for any other reason, please refer to the address provided in the documentation for the DEVICE.

**No Liability for Certain Damages:** EXCEPT AS PROHIBITED BY LAW, FORD MOTOR COMPANY, ANY THIRD PARTY SOFTWARE OR SERVICES SUPPLIERS, MS, MICROSOFT CORPORATION AND THEIR AFFILIATES SHALL HAVE NO LIABILITY FOR ANY INDIRECT, SPECIAL, CONSEQUENTIAL OR INCIDENTAL DAMAGES ARISING FROM OR IN CONNECTION WITH THE USE OR PERFORMANCE OF THE SOFTWARE. THIS LIMITATION SHALL APPLY EVEN IF ANY REMEDY FAILS OF ITS ESSENTIAL PURPOSE. IN NO EVENT SHALL MS, MICROSOFT CORPORATION AND/OR THEIR AFFILIATES BE LIABLE FOR ANY AMOUNT IN EXCESS OF U.S. TWO HUNDRED FIFTY DOLLARS (U.S. \$250.00).

- THERE ARE NO WARRANTIES OTHER THAN THOSE THAT MAY EXPRESSLY BE PROVIDED FOR YOUR NEW VEHICLE.

# Appendices

---

## Adobe

Contains Adobe® [Flash® Player] or [AIR®] technology by Adobe Systems Incorporated. This [Licensee Product] contains [Adobe® Flash® Player] [Adobe® AIR®] software under license from Adobe Systems Incorporated, Copyright ©1995-2009 Adobe Macromedia Software LLC. All rights reserved. Adobe, Flash and AIR are trademarks of Adobe Systems Incorporated.

## End User Notice

### **Microsoft® Windows® Mobile for Automotive Important Safety Information**

This system Ford SYNC™ contains software that is licensed to Manufacturer FORD MOTOR COMPANY by an affiliate of Microsoft Corporation pursuant to a license agreement. Any removal, reproduction, reverse engineering or other unauthorized use of the software from this system in violation of the license agreement is strictly prohibited and may subject you to legal action.

**Read and follow instructions:** Before using your Windows Automotive- based system, read and follow all instructions and safety information provided in this end user manual ("User's Guide"). Not following precautions found in this User's Guide can lead to an accident or other serious consequences.

**Keep User's Guide in vehicle:** When kept in the vehicle, the User's Guide will be a ready reference for you and other users unfamiliar with the Windows Automotive-based system. Please make certain that before using the system for the first time, all persons have access to the User's Guide and read its instructions and safety information carefully.

## WARNING



Operating certain parts of this system while driving can distract your attention away from the road, and possibly cause an accident or other serious consequences. Do not change system settings or enter data non-verbally (using your hands) while driving. Stop the vehicle in a safe and legal manner before attempting these operations. This is important since while setting up or changing some functions you might be required to distract your attention away from the road and remove your hands from the wheel.

---

## General Operation

**Voice Command Control:** Functions within the Windows Automotive-based system may be accomplished using only voice commands. Using voice commands while driving allows you to operate the system without removing your hands from the wheel.

**Prolonged Views of Screen:** Do not access any function requiring a prolonged view of the screen while you are driving. Pull over in a safe and legal manner before attempting to access a function of the system requiring prolonged attention. Even occasional short scans to the screen may be hazardous if your attention has been diverted away from your driving task at a critical time.

**Volume Setting:** Do not raise the volume excessively. Keep the volume at a level where you can still hear outside traffic and emergency signals while driving. Driving while unable to hear these sounds could cause an accident.

# Appendices

---

## **Use of Speech Recognition Functions:**

Speech recognition software is inherently a statistical process which is subject to errors. It is your responsibility to monitor any speech recognition functions included in the system and address any errors.

**Navigation Features:** Any navigation features included in the system are intended to provide turn by turn instructions to get you to a desired destination. Please make certain all persons using this system carefully read and follow instructions and safety information fully.

**Distraction Hazard:** Any navigation features may require manual (non-verbal) setup. Attempting to perform such set-up or insert data while driving can seriously distract your attention and could cause an accident or other serious consequences. Stop the vehicle in a safe and legal manner before attempting these operations.

**Let Your Judgment Prevail:** Any navigation features are provided only as an aid. Make your driving decisions based on your observations of local conditions and existing traffic regulations. Any such feature is not a substitute for your personal judgment. Any route suggestions made by this system should never replace any local traffic regulations or your personal judgment or knowledge of safe driving practices.

**Route Safety:** Do not follow the route suggestions if doing so would result in an unsafe or illegal maneuver, if you would be placed in an unsafe situation, or if you would be directed into an area that you consider unsafe. The driver is ultimately responsible for the safe operation of the vehicle and therefore, must evaluate whether it is safe to follow the suggested directions.

**Potential Map Inaccuracy:** Maps used by this system may be inaccurate because of changes in roads, traffic controls or driving conditions. Always use good judgment and common sense when following the suggested routes.

**Emergency Services:** Do not rely on any navigation features included in the system to route you to emergency services. Ask local authorities or an emergency services operator for these locations. Not all emergency services such as police, fire stations, hospitals and clinics are likely to be contained in the map database for such navigation features.

## **TeleNav Software End User License Agreement**

Please read these terms and conditions carefully before you use the TeleNav Software. Your use of the TeleNav Software indicates that you accept these terms and conditions. If you do not accept these terms and conditions, do not break the seal of the package, launch, or otherwise use the TeleNav Software.

TeleNav may revise this Agreement and the privacy policy at any time, with or without notice to you. You agree to visit <http://www.telenav.com> from time to time to review the then current version of this Agreement and of the privacy policy.

### **1. Safe and Lawful Use**

You acknowledge that devoting attention to the TeleNav Software may pose a risk of injury or death to you and others in situations that otherwise require your undivided attention, and you therefore agree to comply with the following when using the TeleNav Software: (a) observe all traffic laws and otherwise drive safely; (b) use your own personal judgment while driving. If you feel that a route suggested by the TeleNav Software instructs you to perform an unsafe or illegal maneuver,

# Appendices

---

places you in an unsafe situation, or directs you into an area that you consider to be unsafe, do not follow such instructions; (c) do not input destinations, or otherwise manipulate the TeleNav Software, unless your vehicle is stationary and parked; (d) do not use the TeleNav Software for any illegal, unauthorized, unintended, unsafe, hazardous, or unlawful purposes, or in any manner inconsistent with this Agreement; (e) arrange all GPS and wireless devices and cables necessary for use of the TeleNav Software in a secure manner in your vehicle so that they will not interfere with your driving and will not prevent the operation of any safety device (such as an airbag).

You agree to indemnify and hold TeleNav harmless against all claims resulting from any dangerous or otherwise inappropriate use of the TeleNav Software in any moving vehicle, including as a result of your failure to comply with the directions above.

## **2. Account Information**

You agree: (a) when registering the TeleNav Software, to provide TeleNav with true, accurate, current, and complete information about yourself, and (b) to inform TeleNav promptly of any changes to such information, and to keep it true, accurate, current and complete.

## **3. Software License**

Subject to your compliance with the terms of this Agreement, TeleNav hereby grants to you a personal, non-exclusive, non-transferable license (except as expressly permitted below in connection with your permanent transfer of the TeleNav Software license), without the right to sublicense, to use the TeleNav Software (in object code form only) in order to access and use the TeleNav Software. This license shall terminate upon

any termination or expiration of this Agreement. You agree that you will use the TeleNav Software only for your personal business or leisure purposes, and not to provide commercial navigation services to other parties.

### **3.1 License Limitations**

You agree not to do any of the following: (a) reverse engineer, decompile, disassemble, translate, modify, alter or otherwise change the TeleNav Software or any part thereof; (b) attempt to derive the source code, audio library or structure of the TeleNav Software without the prior express written consent of TeleNav; (c) remove from the TeleNav Software, or alter, any of TeleNav's or its suppliers' trademarks, trade names, logos, patent or copyright notices, or other notices or markings; (d) distribute, sublicense or otherwise transfer the TeleNav Software to others, except as part of your permanent transfer of the TeleNav Software; or (e) use the TeleNav Software in any manner that (i) infringes the intellectual property or proprietary rights, rights of publicity or privacy or other rights of any party, (ii) violates any law, statute, ordinance or regulation, including but not limited to laws and regulations related to spamming, privacy, consumer and child protection, obscenity or defamation, or (iii) is harmful, threatening, abusive, harassing, tortuous, defamatory, vulgar, obscene, libelous, or otherwise objectionable; and (f) lease, rent out, or otherwise permit unauthorized access by third parties to the TeleNav Software without advanced written permission of TeleNav.

# Appendices

---

## 4. Disclaimers

To the fullest extent permissible pursuant to applicable law, in no event will TeleNav, its licensors and suppliers, or agents or employees of any of the foregoing, be liable for any decision made or action taken by you or anyone else in reliance on the information provided by the TeleNav Software. TeleNav also does not warrant the accuracy of the map or other data used for the TeleNav Software. Such data may not always reflect reality due to, among other things, road closures, construction, weather, new roads and other changing conditions. You are responsible for the entire risk arising out of your use of the TeleNav Software. For example but without limitation, you agree not to rely on the TeleNav Software for critical navigation in areas where the well-being or survival of you or others is dependent on the accuracy of navigation, as the maps or functionality of the TeleNav Software are not intended to support such high risk applications, especially in more remote geographical areas.

TELENAV EXPRESSLY DISCLAIMS AND EXCLUDES ALL WARRANTIES IN CONNECTION WITH THE TELENAV SOFTWARE, WHETHER STATUTORY, EXPRESS OR IMPLIED, INCLUDING ALL WARRANTIES WHICH MAY ARISE FROM COURSE OF DEALING, CUSTOM OR TRADE AND INCLUDING, BUT NOT LIMITED TO, THE IMPLIED WARRANTIES OF MERCHANTABILITY, FITNESS FOR A PARTICULAR PURPOSE AND NON-INFRINGEMENT OF THIRD PARTY RIGHTS WITH RESPECT TO THE TELENAV SOFTWARE. Certain jurisdictions do not permit the disclaimer of certain warranties, so this limitation may not apply to you.

## 5. Limitation of Liability

TO THE EXTENT PERMITTED UNDER APPLICABLE LAW, UNDER NO CIRCUMSTANCES SHALL TELENAV OR ITS LICENSORS AND SUPPLIERS BE LIABLE TO YOU OR TO ANY THIRD PARTY FOR ANY INDIRECT, INCIDENTAL, CONSEQUENTIAL, SPECIAL OR EXEMPLARY DAMAGES (INCLUDING IN EACH CASE, BUT NOT LIMITED TO, DAMAGES FOR THE INABILITY TO USE THE EQUIPMENT OR ACCESS DATA, LOSS OF DATA, LOSS OF BUSINESS, LOSS OF PROFITS, BUSINESS INTERRUPTION OR THE LIKE) ARISING OUT OF THE USE OF OR INABILITY TO USE THE TELENAV SOFTWARE, EVEN IF TELENAV HAS BEEN ADVISED OF THE POSSIBILITY OF SUCH DAMAGES.

NOTWITHSTANDING ANY DAMAGES THAT YOU MIGHT INCUR FOR ANY REASON WHATSOEVER (INCLUDING, WITHOUT LIMITATION, ALL DAMAGES REFERENCED HEREIN AND ALL DIRECT OR GENERAL DAMAGES IN CONTRACT, TORT (INCLUDING NEGLIGENCE) OR OTHERWISE), THE ENTIRE LIABILITY OF TELENAV AND OF ALL OF TELENAV'S SUPPLIERS SHALL BE LIMITED TO THE AMOUNT ACTUALLY PAID BY YOU FOR THE TELENAV SOFTWARE. SOME STATES AND/OR JURISDICTIONS DO NOT ALLOW THE EXCLUSION OR LIMITATION OF INCIDENTAL OR CONSEQUENTIAL DAMAGES, SO THE ABOVE LIMITATIONS OR EXCLUSIONS MAY NOT APPLY TO YOU.

## 6. Arbitration and Governing Law

You agree that any dispute, claim or controversy arising out of or relating to this Agreement or the TeleNav Software shall be settled by independent arbitration involving a neutral arbitrator and administered by the American Arbitration Association in the County of Santa Clara, California. The arbitrator shall apply the

# Appendices

---

Commercial Arbitration Rules of the American Arbitration Association, and the judgment upon the award rendered by the arbitrator may be entered by any court having jurisdiction. Note that there is no judge or jury in an arbitration proceeding and the decision of the arbitrator shall be binding upon both parties. You expressly agree to waive your right to a jury trial.

This Agreement and performance hereunder will be governed by and construed in accordance with the laws of the State of California, without giving effect to its conflict of laws provisions. To the extent judicial action is necessary in connection with the binding arbitration, both TeleNav and you agree to submit to the exclusive jurisdiction of the courts of the County of Santa Clara, California. The United Nations Convention on Contracts for the International Sale of Goods shall not apply.

## **7. Assignment**

You may not resell, assign, or transfer this Agreement or any of your rights or obligations, except in totality, in connection with your permanent transfer of the TeleNav Software, and expressly conditioned upon the new user of the TeleNav Software agreeing to be bound by the terms and conditions of this Agreement. Any such sale, assignment or transfer that is not expressly permitted under this paragraph will result in immediate termination of this Agreement, without liability to TeleNav, in which case you and all other parties shall immediately cease all use of the TeleNav Software. Notwithstanding the foregoing, TeleNav may assign this Agreement to any other party at any time without notice, provided the assignee remains bound by this Agreement.

## **8. Miscellaneous**

### **8.1**

This Agreement constitutes the entire agreement between TeleNav and you with respect to the subject matter hereof.

### **8.2**

Except for the limited licenses expressly granted in this Agreement, TeleNav retains all right, title and interest in and to the TeleNav Software, including without limitation all related intellectual property rights. No licenses or other rights which are not expressly granted in this Agreement are intended to, or shall be, granted or conferred by implication, statute, inducement, estoppel or otherwise, and TeleNav and its suppliers and licensors hereby reserve all of their respective rights other than the licenses explicitly granted in this Agreement

### **8.3**

By using the TeleNav Software, you consent to receive from TeleNav all communications, including notices, agreements, legally required disclosures or other information in connection with the TeleNav Software (collectively, "Notices") electronically. TeleNav may provide such Notices by posting them on TeleNav's Website or by downloading such Notices to your wireless device. If you desire to withdraw your consent to receive Notices electronically, you must discontinue your use of the TeleNav Software.

### **8.4**

TeleNav's or your failure to require performance of any provision shall not affect that party's right to require performance at any time thereafter, nor shall a waiver of any breach or default of this Agreement constitute a waiver of any subsequent breach or default or a waiver of the provision itself.

# Appendices

---

## 8.5

If any provision herein is held unenforceable, then such provision will be modified to reflect the intention of the parties, and the remaining provisions of this Agreement will remain in full force and effect

## 8.6

The headings in this Agreement are for convenience of reference only, will not be deemed to be a part of this Agreement, and will not be referred to in connection with the construction or interpretation of this Agreement. As used in this Agreement, the words "include" and "including" and variations thereof, will not be deemed to be terms of limitation, but rather will be deemed to be followed by the words "without limitation".

## 9. Other Vendors Terms and Conditions

The TeleNav Software utilizes map and other data licensed to TeleNav by third party vendors for the benefit of you and other end users. This Agreement includes end-user terms applicable to these companies (included at the end of this Agreement), and thus your use of the TeleNav Software is also subject to such terms. You agree to comply with the following additional terms and conditions, which are applicable to TeleNav's third party vendor licensors:

### *NavTeq End User License Agreement*

#### **END USER TERMS**

The content provided ("Data") is licensed, not sold. By opening this package, or installing, copying, or otherwise using the Data, you agree to be bound by the terms of this agreement. If you do not agree to the terms of this agreement, you are not permitted to install, copy, use, resell or transfer the Data. If you wish to reject the terms of this agreement, and have not

installed, copied, or used the Data, you must contact your retailer or NAVTEQ North America, LLC ("NT") within thirty (30) days of purchase for a refund of your purchase price. To contact NT, please visit [www.navteq.com](http://www.navteq.com).

The Data is provided for your personal, internal use only and may not be resold. It is protected by copyright, and is subject to the following terms (this "End User License Agreement") and conditions which are agreed to by you, on the one hand, and NAVTEQ North America, LLC ("NT") and its licensors (including their licensors and suppliers) on the other hand.

The Data for areas of Canada includes information taken with permission from Canadian authorities, including: © Her Majesty the Queen in Right of Canada, © Queen's Printer for Ontario, © Canada Post Corporation, GeoBase®.

NT holds a nonexclusive license from the United States Postal Service® to publish and sell ZIP+4® information.

© United States Postal Service® 2009. Prices are not established, controlled or approved by the United States Postal Service® The following trademarks and registrations are owned by the USPS: United States Postal Service, USPS, and ZIP+4.

The Data for Mexico includes certain Data from Instituto Nacional de Estadística y Geografía.

#### **TERMS AND CONDITIONS**

**License Limitations on Use:** You agree that your license to use this Data is limited to and conditioned on use for solely personal, noncommercial purposes, and not for service bureau, timesharing or other similar purposes. Except as otherwise set forth herein, you agree not to otherwise



# Appendices

reproduce, copy, modify, decompile, disassemble or reverse engineer any portion of this Data, and may not transfer or distribute it in any form, for any purpose, except to the extent permitted by mandatory laws.

**License Limitations on Transfer:** Your limited license does not allow transfer or resale of the Data, except on the condition that you may transfer the Data and all accompanying materials on a permanent basis if: (a) you retain no copies of the Data; (b) the recipient agrees to the terms of this End User License Agreement; and (c) you transfer the Data in the exact same form as you purchased it by physically transferring the original media (e.g., the CD-ROM or DVD you purchased), all original packaging, all Manuals and other documentation. Specifically, Multi-disc sets may only be transferred or sold as a complete set as provided to you and not as a subset thereof.

**Additional License Limitations:** Except where you have been specifically licensed to do so by NT in a separate written agreement, and without limiting the preceding paragraph, your license is conditioned on use of the Data as prescribed in this agreement, and you may not (a) use this Data with any products, systems, or applications installed or otherwise connected to or in communication with vehicles capable of vehicle navigation, positioning, dispatch, real time route guidance, fleet management or similar applications; or (b) with, or in communication with, including without limitation, cellular phones, palmtop and handheld computers, pagers, and personal digital assistants or PDAs.

## WARNING



This Data may contain inaccurate or incomplete information due to the passage of time, changing circumstances, sources used and the nature of collecting comprehensive geographic Data, any of which may lead to incorrect results.

**No Warranty:** This Data is provided to you "as is", and you agree to use it at your own risk. NT and its licensors (and their licensors and suppliers) make no guarantees, representations or warranties of any kind, express or implied, arising by law or otherwise, including but not limited to, content, quality, accuracy, completeness, effectiveness, reliability, fitness for a particular purpose, usefulness, use or results to be obtained from this Data, or that the Data or server will be uninterrupted or error free.

**Disclaimer of Warranty:** NT AND ITS LICENSORS (INCLUDING THEIR LICENSORS AND SUPPLIERS) DISCLAIM ANY WARRANTIES, EXPRESS OR IMPLIED, OF QUALITY, PERFORMANCE, MERCHANTABILITY, FITNESS FOR A PARTICULAR PURPOSE OR NON-INFRINGEMENT. Some States, Territories and Countries do not allow certain warranty exclusions, so to that extent the above exclusion may not apply to you.

**Disclaimer of Liability:** NT AND ITS LICENSORS (INCLUDING THEIR LICENSORS AND SUPPLIERS) SHALL NOT BE LIABLE TO YOU IN RESPECT OF ANY CLAIM, DEMAND OR ACTION, IRRESPECTIVE OF THE NATURE OF THE CAUSE OF THE CLAIM, DEMAND OR ACTION ALLEGING ANY LOSS, INJURY OR DAMAGES, DIRECT OR INDIRECT, WHICH MAY RESULT FROM THE USE OR POSSESSION OF THIS DATA; OR FOR ANY LOSS OF PROFIT, REVENUE, CONTRACTS

# Appendices

---

OR SAVINGS, OR ANY OTHER DIRECT, INDIRECT, INCIDENTAL, SPECIAL OR CONSEQUENTIAL DAMAGES ARISING OUT OF YOUR USE OF OR INABILITY TO USE THIS DATA, ANY DEFECT IN THIS DATA, OR THE BREACH OF THESE TERMS OR CONDITIONS, WHETHER IN AN ACTION IN CONTRACT OR TORT OR BASED ON A WARRANTY, EVEN IF NT OR ITS LICENSORS HAVE BEEN ADVISED OF THE POSSIBILITY OF SUCH DAMAGES. Some States, Territories and Countries do not allow certain liability exclusions or damages limitations, so to that extent the above may not apply to you.

**Export Control:** You agree not to export from anywhere any part of the Data or any direct product thereof except in compliance with, and with all licenses and approvals required under, applicable export laws, rules and regulations, including but not limited to the laws, rules and regulations administered by the Office of Foreign Assets Control of the U.S. Department of Commerce and the Bureau of Industry and Security of the U.S. Department of Commerce. To the extent that any such export laws, rules or regulations prohibit NT from complying with any of its obligations hereunder to deliver or distribute Data, such failure shall be excused and shall not constitute a breach of this Agreement.

**Entire Agreement:** These terms and conditions constitute the entire agreement between NT (and its licensors, including their licensors and suppliers) and you pertaining to the subject matter hereof, and supersedes in their entirety any and all written or oral agreements previously existing between us with respect to such subject matter.

**Severability:** You and NT agree that if any portion of this agreement is found illegal or unenforceable, that portion shall be severed and the remainder of the Agreement shall be given full force and effect.

**Governing Law:** The above terms and conditions shall be governed by the laws of the State of Illinois, without giving effect to (i) its conflict of laws provisions, or (ii) the United Nations Convention for Contracts for the International Sale of Goods, which is explicitly excluded. You agree to submit to the personal jurisdiction of the State of Illinois for any and all disputes, claims and actions arising from or in connection with the Data provided to you hereunder.

**Government End Users:** If the Data is being acquired by or on behalf of the United States government or any other entity seeking or applying rights similar to those customarily claimed by the United States government, this Data is a "commercial term" as that term is defined at 48 C.F.R. ("FAR") 2.101, is licensed in accordance with this End User License Agreement, and each copy of Data delivered or otherwise furnished shall be marked and embedded as appropriate with the following "Notice of Use", and be treated in accordance with such Notice:

## NOTICE OF USE

CONTRACTOR  
(MANUFACTURER/SUPPLIER)

NAME:

## NAVTEQ

CONTRACTOR  
(MANUFACTURER/SUPPLIER)

ADDRESS:

**425 West Randolph Street, Chicago, IL  
60606.**

# Appendices

---

This Data is a commercial item as defined in FAR 2.101

and is subject to the End User License Agreement under

which this Data was provided.

© 2011 NAVTEQ. All rights reserved.

If the Contracting Officer, federal government agency, or any federal official refuses to use the legend provided herein, the Contracting Officer, federal government agency, or any federal official must notify NAVTEQ prior to seeking additional or alternative rights in the Data.

Wi-Fi hotspot data provided by JiWire, © 2013 JiWire.

## **Gracenote® Copyright**

CD and music-related data from Gracenote, Inc., copyright© 2000-2007 Gracenote. Gracenote Software, copyright © 2000-2007 Gracenote. This product and service may practice one or more of the following U.S. Patents #5,987,525, #6,061,680, #6,154,773, #6,161,132, #6,230,192, #6,230,207, #6,240,459, #6,330,593 and other patents issued or pending. Some services supplied under license from Open Globe, Inc. for U.S. Patent: #6,304,523.

Gracenote and CDDB are registered trademarks of Gracenote. The Gracenote logo and logotype, and the "Powered by Gracenote™" logo are trademarks of Gracenote.

## **Gracenote® End User License Agreement (EULA)**

This device contains software from Gracenote, Inc. of 2000 Powell Street Emeryville, California 94608 ("Gracenote").

The software from Gracenote (the "Gracenote Software") enables this device to do disc and music file identification and obtain music-related information, including name, artist, track, and title information ("Gracenote Data") from online servers ("Gracenote Servers"), and to perform other functions. You may use Gracenote Data only by means of the intended End User functions of this device.

This device may contain content belonging to Gracenote's providers. If so, all of the restrictions set forth herein with respect to Gracenote Data shall also apply to such content and such content providers shall be entitled to all of the benefits and protections set forth herein that are available to Gracenote.

You agree that you will use the content from Gracenote ("Gracenote Content"), Gracenote Data, the Gracenote Software, and Gracenote Servers for your own personal, non-commercial use only. You agree not to assign, copy, transfer or transmit the Gracenote Content, Gracenote Software or any Gracenote Data (except in a Tag associated with a music file) to any third party. YOU AGREE NOT TO USE OR EXPLOIT GRACENOTE CONTENT, GRACENOTE DATA, THE GRACENOTE SOFTWARE, OR GRACENOTE SERVERS, EXCEPT AS EXPRESSLY PERMITTED HEREIN.

You agree that your non-exclusive licenses to use the Gracenote Content, Gracenote Data, the Gracenote Software, and Gracenote Servers will terminate if you violate these restrictions. If your licenses terminate, you agree to cease any and all use of the Gracenote Content, Gracenote Data, the Gracenote Software, and Gracenote Servers. Gracenote, respectively, reserve all rights in Gracenote Data, the Gracenote Software, and the Gracenote Servers and Gracenote Content, including all ownership rights. Under no circumstances will either Gracenote

# Appendices

---

become liable for any payment to you for any information that you provide, including any copyrighted material or music file information. You agree that Gracenote may enforce its respective rights, collectively or separately, under this agreement against you, directly in each company's own name.

Gracenote uses a unique identifier to track queries for statistical purposes. The purpose of a randomly assigned numeric identifier is to allow Gracenote to count queries without knowing anything about who you are. For more information, see the web page at [www.gracenote.com](http://www.gracenote.com) for the Gracenote Privacy Policy.

THE GRACENOTE SOFTWARE, EACH ITEM OF GRACENOTE DATA AND THE GRACENOTE CONTENT ARE LICENSED TO YOU "AS IS". NEITHER GRACENOTE MAKES ANY REPRESENTATIONS OR WARRANTIES, EXPRESS OR IMPLIED, REGARDING THE ACCURACY OF ANY GRACENOTE DATA FROM THE GRACENOTE SERVERS OR GRACENOTE CONTENT. GRACENOTE COLLECTIVELY AND SEPARATELY RESERVE THE RIGHT TO DELETE DATA AND/OR CONTENT FROM THE COMPANIES' RESPECTIVE SERVERS OR, IN THE CASE OF GRACENOTE, CHANGE DATA CATEGORIES FOR ANY CAUSE THAT GRACENOTE DEEMS SUFFICIENT. NO WARRANTY IS MADE THAT EITHER GRACENOTE CONTENT OR THE GRACENOTE SOFTWARE OR GRACENOTE SERVERS ARE ERROR-FREE OR THAT THE FUNCTIONING OF THE GRACENOTE SOFTWARE OR GRACENOTE SERVERS WILL BE UNINTERRUPTED. GRACENOTE IS NOT OBLIGATED TO PROVIDE YOU WITH ANY ENHANCED OR ADDITIONAL DATA TYPES THAT GRACENOTE MAY CHOOSE TO PROVIDE IN THE FUTURE AND IS FREE TO DISCONTINUE ITS ONLINE SERVICES AT ANY TIME. GRACENOTE DISCLAIM ALL

WARRANTIES EXPRESS OR IMPLIED, INCLUDING, BUT NOT LIMITED TO, IMPLIED WARRANTIES OF MERCHANTABILITY, FITNESS FOR A PARTICULAR PURPOSE, TITLE, AND NON-INFRINGEMENT. NEITHER GRACENOTE WARRANTS THE RESULTS THAT WILL BE OBTAINED BY YOUR USE OF THE GRACENOTE SOFTWARE OR ANY GRACENOTE SERVER. IN NO CASE WILL GRACENOTE BE LIABLE FOR ANY CONSEQUENTIAL OR INCIDENTAL DAMAGES OR FOR ANY LOST PROFITS OR LOST REVENUES FOR ANY REASON WHATSOEVER.

© Gracenote 2007.

FCC ID: KMHSYNG2

IC: 1422A-SYNG2

This device complies with Part 15 of the FCC Rules and with RSS-210 of Industry Canada. Operation is subject to the following two conditions: (1) This device may not cause harmful interference, and (2) this device must accept any interference received, including interference that may cause undesired operation.

## WARNING



Changes or modifications not expressly approved by the party responsible for compliance could void the user's authority to operate the equipment. The term "IC" before the radio certification number only signifies that Industry Canada technical specifications were met.

The antenna used for this transmitter must not be co-located or operating in conjunction with any other antenna or transmitter.

# Index

## A

A/C	
See: Climate Control.....	65
About This Manual.....	5
ABS	
See: Brakes.....	92
ABS driving hints	
See: Hints on Driving With Anti-Lock Brakes.....	92
Accessories	
See: Replacement Parts Recommendation.....	8
Adjusting the Steering Wheel.....	38
Airbag Disposal.....	28
Air Conditioning	
See: Climate Control.....	65
Air Filter	
See: Changing the Engine Air Filter.....	140
Air Vents.....	65
Center Air Vents.....	65
Side Air Vents.....	65
Alarm	
See: Anti-Theft Alarm.....	37
Anti-Theft Alarm.....	37
Arming the Alarm.....	37
Disarming the Alarm.....	37
Appendices.....	219
At a Glance.....	10
Audible Warnings and Indicators.....	55
Airbag Indicator Lamp Malfunction.....	55
Door Ajar.....	55
Headlamps On.....	55
Parking Brake.....	55
Safety Belt Minder.....	55
Vehicle not in Park.....	55
Audio Control.....	38
Type 1.....	39
Type 2.....	39
Audio Input Jack.....	182
Audio System.....	166
General Information.....	166
Audio Troubleshooting.....	183

Audio Unit - Vehicles With: AM/FM/Aux In/USB/Bluetooth.....	171
Bluetooth Audio Streaming.....	177
FCC Notice.....	178
iPod.....	177
Making and Receiving Calls.....	176
Phone.....	174
Phone Menu Options.....	176
Sound Button.....	173
Station Preset Buttons.....	173
Station Tuning Control.....	173
USB.....	176
Waveband Button.....	173
Audio Unit - Vehicles With: AM/FM/CD/SYNC.....	167
Automatic Volume Control.....	171
Autostore Control.....	171
Sound Button.....	170
Station Preset Buttons.....	170
Station Tuning Control.....	170
Waveband Button.....	170
Automatic Climate Control.....	67
Automatic Transmission.....	88
Brake-Shift Interlock Override.....	90
PowerShift Automatic Transmission.....	88
SelectShift Automatic™ Transmission.....	89
Auxiliary Power Points.....	76
Location.....	76

## B

Battery	
See: Changing the 12V Battery.....	131
Bonnet Lock	
See: Opening and Closing the Hood.....	123
Bottle Holder.....	78
Brake Fluid Check.....	129
Brakes.....	92
General Information.....	92
Breaking-In.....	100
Brakes and Clutch.....	100
Engine.....	100
Tires.....	100
Bulb Specification Chart.....	139

# Index

<b>C</b>	
Cabin Air Filter.....	71
Capacities and Specifications - 1.2L	
TiVCT/1.5L TiVCT.....	162
Capacities.....	162
Specifications.....	163
Capacities and Specifications - 1.5L	
TDCi.....	163
Capacities.....	164
Specifications.....	164
Capacities and Specifications.....	153
Car Wash	
See: Cleaning the Exterior.....	141
Catalytic Converter.....	84
Driving with a Catalytic Converter.....	84
Center Console.....	77
My Ford Dock.....	77
Changing a Bulb - 4-Door.....	134
Central High Mounted Brake Lamp.....	136
Front Fog Lamps.....	135
Headlamp.....	134
Interior Lamp.....	136
License Plate Lamp.....	136
Luggage Compartment Lamp, Footwell Lamp and Liftgate Lamp.....	136
Rear Lamps.....	135
Changing a Bulb - 5-Door.....	136
Central High Mounted Brake Lamp.....	138
Front Fog Lamps.....	138
Headlamp.....	137
Interior Lamp.....	139
License Plate Lamp.....	139
Luggage Compartment Lamp, Footwell Lamp and Liftgate Lamp.....	139
Rear Lamps.....	138
Changing a Fuse.....	122
Changing a Road Wheel.....	146
Assembling the Wheel Brace.....	149
Installing a Road Wheel.....	151
Jacking and Lifting Points.....	148
Lug Nuts.....	146
Removing a Road Wheel.....	150
Removing the Wheel Trim.....	149
Vehicle Jack.....	146
Vehicles With a Spare Wheel.....	146
Changing the 12V Battery.....	131
Changing the Engine Air Filter.....	140
Changing the Air Filter Element.....	140
Changing the Wiper Blades.....	132
Changing the Rear Window Wiper Blade.....	132
Changing the Windshield Wiper Blades.....	132
Checking MyKey System Status.....	32
MyKey Distance.....	32
Number of Admin Keys.....	32
Number of MyKeys.....	32
Checking the Wiper Blades.....	131
Child Restraint Positioning.....	19
Child Safety.....	18
Child Safety Locks.....	21
Left-Hand Side.....	21
Right-Hand Side.....	21
Cleaning the Alloy Wheels.....	142
Cleaning the Engine.....	141
Cleaning the Exterior.....	141
Body Paintwork Preservation.....	141
Cleaning the Chrome Trim.....	141
Cleaning the Headlamps.....	141
Cleaning the Rear Window.....	141
Cleaning the Interior.....	142
Instrument Cluster Screens, LCD Screens and Radio Screens.....	142
Rear Windows.....	142
Seatbelts.....	142
Clearing All MyKeys.....	32
Climate Control.....	65
Principle of Operation.....	65
Cold Weather Precautions.....	101
Compact Disc Player.....	178
CD Text Display Options.....	181
Compact Disc Playback.....	178
Compact Disc Track Scanning.....	179
Ending Compact Disc Playback.....	181
Fast Forward and Reverse.....	178
MP3 and WMA Display Options.....	181
MP3 and WMA File Playback.....	179
Repeat Compact Disc Tracks.....	179
Shuffle and Random.....	178
Track Selection.....	178
Coolant Check	
See: Engine Coolant Check.....	128
Crash Sensors and Airbag Indicator.....	27
Creating a MyKey.....	31

# Index

Cup Holders.....77

## D

Data Recording.....7  
Direction Indicators.....46  
Draining the Fuel Filter Water Trap.....130  
Driver and Passenger Airbags.....26  
    Children and Airbags.....26  
    Proper Driver and Front Passenger Seating  
        Adjustment.....26  
Driving Aids.....96  
Driving Hints.....100  
Driving Through Water.....101

## E

Economical Driving.....100  
Electromagnetic Compatibility.....219  
End User License Agreement.....220  
    SYNC® End User License Agreement  
        (EULA).....220  
Engine Coolant Check.....128  
    Adding Engine Coolant.....129  
Engine Immobilizer  
    See: Passive Anti-Theft System.....37  
Engine Oil Check.....127  
    Checking the Oil Level.....127  
    Oil Consumption.....128  
    Oil Filter.....128  
    Topping Up.....127  
Engine Oil Dipstick - 1.2L TiVCT/1.5L  
    TiVCT.....127  
Engine Oil Dipstick - 1.5L TDCi.....127  
Engine Specifications - 1.2L TiVCT.....153  
Engine Specifications - 1.5L TDCi.....155  
Engine Specifications - 1.5L TiVCT.....154  
Event Data Recording  
    See: Data Recording.....7  
Exterior Mirrors.....48  
    Folding Mirrors.....48  
    Manual Exterior Mirrors.....49  
    Power Exterior Mirrors.....49  
    Power Folding Mirrors.....49

## F

Fastening the Seatbelts.....22  
    Using Safety Belts During Pregnancy.....23  
First Aid Kit.....103  
Floor Mats.....101  
Fog Lamps - Front  
    See: Front Fog Lamps.....44  
Fog Lamps - Rear  
    See: Rear Fog Lamps.....44  
Front Exterior Overview - 4-Door.....10  
Front Exterior Overview - 5-Door.....11  
Front Fog Lamps.....44  
Fuel and Refueling.....82  
Fuel Consumption.....85  
    Calculating Fuel Economy.....85  
    Filling the Fuel Tank.....85  
Fuel Quality - Diesel.....83  
    Biodiesel Usage.....83  
    Long-Term Storage.....83  
Fuel Quality - Gasoline.....82  
    Long-Term Storage.....83  
Fuel Shutoff.....103  
    Vehicles with Airbag.....103  
    Vehicles without Airbag.....103  
Fuse Box Locations.....108  
    Battery Fuse Box.....108  
    Engine Compartment Fuse Box.....108  
    Passenger Compartment Fuse Box.....108  
Fuses.....108  
Fuse Specification Chart - Diesel.....115  
    Battery Fuse Box.....121  
    Engine Compartment Fuse Box.....116  
    Passenger Compartment Fuse Box.....120  
Fuse Specification Chart -  
    Gasoline.....108  
    Battery Fuse Box.....115  
    Engine Compartment Fuse Box.....109  
    Passenger Compartment Fuse Box.....113

## G

Gauges.....51  
    Fuel Gauge.....51  
    Information Display.....51  
    Maximum Engine Speed.....52  
    Tachometer.....51

# Index

General Information on Radio Frequencies.....	29	Installing Child Restraints.....	18
<b>H</b>		Booster Seats.....	19
Handbrake See: Parking Brake.....	92	Child Restraints for Different Mass Groups.....	18
Hazard Warning Flashers.....	103	Instrument Cluster.....	51
Headlamp Exit Delay.....	43	Instrument Panel Overview.....	16
Headlamp Leveling.....	45	Interior Lamps.....	46
Recommended headlamp levelling switch positions.....	45	Courtesy Lamp.....	46
Headlamp Removal See: Removing a Headlamp.....	133	Interior Mirror.....	50
Head Restraints.....	72	Introduction.....	5
Adjusting the Head Restraint.....	73	<b>J</b>	
Heated Windows.....	71	Jump Starting the Vehicle.....	104
Heated Rear Window.....	71	Connecting the Jumper Cables.....	104
Heating See: Climate Control.....	65	Jump Starting.....	105
Hill Start Assist.....	93	Preparing Your Vehicle.....	104
Using Hill Start Assist.....	93	Removing the Jumper Cables.....	105
Hints on Controlling the Interior Climate.....	68	<b>K</b>	
Cooling the Interior Quickly.....	69	Keys and Remote Controls.....	29
General Hints.....	68	<b>L</b>	
Heating the Interior Quickly.....	69	Lighting Control.....	43
Recommended Settings for Cooling.....	70	Headlamp Flasher.....	43
Recommended Settings for Heating.....	69	High Beams.....	43
Vehicle Stationary for Extended Periods during Extreme High Ambient Temperatures.....	70	Parking Lamps.....	43
Windshield and Side Window Defrosting or Defogging in Cold Weather.....	70	Lighting.....	43
Hints on Driving With Anti-Lock Brakes.....	92	Load Carrying.....	97
Hood Lock See: Opening and Closing the Hood.....	123	General Information.....	97
<b>I</b>		Locking and Unlocking.....	34
Ignition Switch.....	79	Autolock Feature.....	34
Information Displays.....	56	Auto Relock.....	34
General Information.....	56	Battery Saver.....	35
Information Messages.....	60	Illuminated Entry.....	35
		Illuminated Exit.....	35
		Luggage Compartment.....	35
		Manual Door Locks.....	34
		Remote Control.....	34
		Locks.....	34
		Luggage Covers - 5-Door.....	97
		Removing the Cover.....	97
		Lug Nuts See: Changing a Road Wheel.....	146



# Index

## M

Maintenance.....	123
General Information.....	123
Manual Climate Control.....	66
Manual Liftgate.....	36
Opening and Closing the Liftgate.....	36
Manual Seats.....	73
Adjusting the Height of the Driver Seat.....	74
Moving the Seat Backward and Forward.....	73
Recline Adjustment.....	74
Manual Transmission.....	87
5-Speed Manual Transmission.....	87
Map Pockets.....	78
Media Hub.....	184
Message Center See: Information Displays.....	56
Mirrors See: Windows and Mirrors.....	47
Mobile Communications Equipment.....	8
MyKey Troubleshooting.....	33
All Vehicles.....	33
MyKey™.....	31
Principle of Operation.....	31

## O

Oil Check See: Engine Oil Check.....	127
Opening and Closing the Hood.....	123
Closing the Hood.....	124
Opening the Hood.....	123

## P

Parking Brake.....	92
All Vehicles.....	93
Vehicles With Automatic Transmission.....	92
Vehicles With Manual Transmission.....	92
Passive Anti-Theft System.....	37
Arming the Engine Immobilizer.....	37
Coded Keys.....	37
Disarming the Engine Immobilizer.....	37
Principle of Operation.....	37

PATS See: Passive Anti-Theft System.....	37
Personalized Settings.....	59
Measure Units.....	59
Post-Crash Alert System.....	106
Power Door Locks See: Locking and Unlocking.....	34
Power Windows - Vehicles With: One-Touch Up and Down Driver Window.....	47
Bounce-Back.....	47
One-Touch Down.....	47
One-Touch Up.....	47
Window Lock.....	47
Programming a MyKey.....	32
Optional Settings.....	32

## R

Rear Exterior Overview - 4-Door.....	12
Rear Exterior Overview - 5-Door.....	13
Rear Fog Lamps.....	44
Rear Seats.....	74
Folding the Seat Backrest.....	74
Reclining the Seat Back.....	74
Unfolding the Seat Backrest.....	75
Rear Window Wiper and Washers - 5-Door.....	42
Intermittent Wipe.....	42
Rear Window Washer.....	42
Reverse Gear Wipe.....	42
Refueling.....	84
Fuel Filler Cap.....	85
Fuel Filler Door.....	84
Remote Control.....	29
Changing the Remote Control Battery.....	29
Remote Control With a Folding Key Blade.....	29
Removing a Headlamp.....	133
Replacement Parts Recommendation.....	8
Collision Repairs.....	8
Scheduled Maintenance and Mechanical Repairs.....	8
Warranty on Replacement Parts.....	8
Replacing a Lost Key or Remote Control.....	30
Roadside Emergencies.....	103

# Index

Running-In	
See: Breaking-In.....	100
Running Out of Fuel.....	83

## S

Safety Precautions.....	82
Seatbelt Height Adjustment.....	23
Seatbelt Reminder.....	24
Deactivating the Safety Belt Minder.....	24
Seatbelts.....	22
Seatbelt Warning Lamp and Indicator	
Chime.....	23
Conditions of operation.....	24
Seats.....	72
Security.....	37
Side Airbags.....	27
Side Curtain Airbags.....	27
Sitting in the Correct Position.....	72
Special Notices.....	8
Stability Control.....	95
Principle of Operation.....	95
Starter Switch	
See: Ignition Switch.....	79
Starting a Diesel Engine.....	81
Cold or Hot Engine.....	81
Failure to Start.....	81
Starting a Gasoline Engine.....	80
Cold or Hot Engine.....	80
Engine Idle Speed after Starting.....	80
Failure to Start.....	80
Fuel Flooded Engine.....	80
Starting and Stopping the Engine.....	79
General Information.....	79
Steering.....	96
Electric Power Steering.....	96
Steering Wheel Lock.....	79
Steering Wheel.....	38
Storage Compartments.....	77
Supplementary Restraints System.....	25
Principle of Operation.....	25
Switching Off the Engine.....	81
Vehicles With a Turbocharger.....	81
Symbols Glossary.....	5
SYNC™ Applications and	
Services.....	200
Emergency Assistance.....	203
Mobile Apps (Ford Applink™).....	200

SYNC™.....	185
General Information.....	185
SYNC™ Troubleshooting.....	208

## T

Tailgate	
See: Manual Liftgate.....	36
Technical Specifications	
See: Capacities and Specifications.....	153
Tire Care.....	145
Risks on the Road.....	145
Tire Pressures.....	152
Tires	
See: Wheels and Tires.....	145
Towing Points.....	98
Front Towing Eye.....	98
Rear Towing Hook.....	98
Towing the Vehicle on Four Wheels.....	99
All Vehicles.....	99
Vehicles with Automatic	
Transmission.....	99
Towing.....	98
Traction Control.....	94
Principle of Operation.....	94
Transmission.....	87
Transmission	
See: Transmission.....	87
Transporting the Vehicle.....	106
Trip Computer.....	59
Average Fuel Economy.....	59
Average Speed.....	59
Distance to Empty.....	59
Instantaneous Fuel Economy.....	59
Odometer.....	59
Outside Ambient Temperature	
Indication.....	59
Shift Indicator.....	59
Trip Odometer.....	59

## U

Under Hood Overview - 1.2L TiVCT/1.5L	
TiVCT.....	125
Under Hood Overview - 1.5L TDCI.....	126
USB Port.....	184
Using MyKey With Remote Start	
Systems.....	32

# Index

Using Stability Control.....	95	Vehicle Interior Overview - 5-Door.....	15
Switching the System Off and On Using the Information Display Controls.....	95	Vehicle Storage.....	143
Using SYNC™ With Your Media Player.....	205	Battery.....	144
Connecting Your Digital Media Player to SYNC™ via Bluetooth®.....	208	Body.....	143
Connecting Your Digital Media Player to SYNC™ via the AUX Port.....	208	Brakes.....	144
Connecting Your Digital Media Player to SYNC™ via the USB Port.....	206	Cooling system.....	144
Using SYNC™ With Your Phone.....	192	Engine.....	143
Changing the active phone.....	194	Fuel system.....	144
Connecting a previously paired phone with SYNC™.....	194	General.....	143
Downloading phonebook.....	194	Miscellaneous.....	144
Making a call.....	196	Removing Vehicle From Storage.....	144
Muting and Unmuting the microphone.....	198	Tires.....	144
Ongoing calls while entering and exiting the vehicle.....	199	Ventilation	
Pairing a Phone for the First Time.....	193	See: Climate Control.....	65
Pairing Subsequent Phones.....	194	Vents	
Phone Voice Commands.....	195	See: Air Vents.....	65
Receiving an incoming call.....	198	VIN	
Receiving a second incoming call.....	198	See: Vehicle Identification Number.....	161
Switching between speaker phone and hands-free mode.....	198	Voice Control.....	40
Text Messaging.....	199		
Using the Speed Dial Feature.....	197		
Using Traction Control.....	94		
Switching the System Off and On Using the Button.....	94		
Switching the System Off and On Using the Information Display Controls.....	94		
Using Voice Recognition.....	190		
Helpful Hints.....	191		
Initiating a Voice Session.....	190		
System Interaction and Feedback.....	191		
<b>V</b>			
Vehicle Care.....	141		
Vehicle Dimensions - 4-Door.....	157		
Vehicle Dimensions - 5-Door.....	159		
Vehicle Identification Number.....	161		
Vehicle Identification Plate.....	161		
Vehicle Interior Overview - 4-Door.....	14		

# Index

## W

Warning Lamps and Indicators.....	52
Anti-Lock Brake System Warning Lamp.....	52
Battery Warning Lamp.....	52
Brake System Warning Lamp.....	52
Direction Indicator.....	52
Door Ajar Warning Lamp.....	52
Engine Coolant Temperature Warning Lamp.....	53
Engine Oil Warning Lamp.....	53
Engine Warning Lamps.....	53
Front Airbag Warning Lamp.....	53
Front Fog Lamps Indicator.....	53
Fuel Heater Indicator.....	53
Headlamp Indicator.....	54
High Beam Indicator.....	54
Hill Start Assist.....	54
Low Fuel Level Warning Lamp.....	54
Malfunction Indicator Lamp.....	54
Over Speed Warning.....	54
Power Steering.....	54
Rear Fog Lamp.....	54
Scheduled Maintenance Indicator Lamp.....	54
Seat belt reminder.....	54
Shift Indicator.....	54
Traction and Stability Control Indicator.....	55
Traction and Stability Control Off.....	55
Water-In-Fuel.....	55
Warning Triangle.....	103
Washer Fluid Check.....	130
Washers See: Cleaning the Exterior.....	141
See: Wipers and Washers.....	41
Weights.....	156
Wheel Nuts See: Changing a Road Wheel.....	146
Wheels and Tires.....	145
General Information.....	145
Windows and Mirrors.....	47
Windshield Washers.....	41
Windshield Wipers.....	41
Intermittent Wipe.....	41
Wiper Blades See: Checking the Wiper Blades.....	131

Wipers and Washers.....	41
-------------------------	----