



MAGNITE

OWNER'S MANUAL

Foreword

This manual was prepared to help you understand the operation and maintenance of your vehicle so that you may enjoy many kilometers (miles) of driving pleasure. Please read through this manual before operating your vehicle.

A separate Warranty Information & Maintenance Booklet explains details about the warranties covering your vehicle.

Your NISSAN dealer knows your vehicle best. When you require any service or have any questions, we will be glad to assist you with the extensive resources available for you.

IMPORTANT SAFETY INFORMATION

Reminders for safety!

Follow these important driving rules to help ensure a safe and complete trip for you and your passengers!

- **NEVER drive under the influence of alcohol or drugs.**
- **ALWAYS observe posted speed limits and never drive too fast for conditions.**
- **ALWAYS use your seat belts and appropriate child restraint systems. Preteen children should be seated in the rear seat.**
- **ALWAYS provide information about the proper use of vehicle safety features to all occupants of the vehicle.**
- **ALWAYS review this Owner's Manual for important safety information.**

When reading the manual

This manual includes information for all options available on this model. Therefore, you may find some information that does not apply to your vehicle.

All information, specifications and illustrations in this manual are those in effect at the time of printing. NISSAN reserves the right to change specifications or designs without notice and without obligation.

MODIFICATION OF YOUR VEHICLE

This vehicle should not be modified. Modification could affect its performance, safety or durability, and may even violate governmental regulations. In addition, damage or performance problems resulting from modifications may not be covered under NISSAN warranties.

Read first — then drive safely

Before driving your vehicle, read this Owner's Manual carefully. This will ensure familiarity with controls and maintenance requirements, assisting you in the safe operation of your vehicle.

Throughout this manual we have used the symbol  followed by the word **WARNING**. This is used to indicate the presence of a hazard that could cause death or serious personal injury. To avoid or reduce the risk, the procedures must be followed precisely.

The symbol  followed by the word **CAUTION** is also used throughout this manual to indicate the presence of a hazard that could cause minor or moderate personal injury or damages to your vehicle. To avoid or reduce the risk, the procedures must be followed carefully.

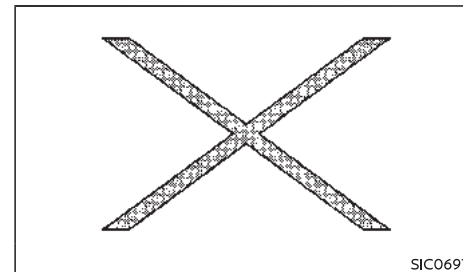

If you see this symbol, it means **"Do not do this"** or **"Do not let this happen"**.



If you see a symbol similar to these in an illustration, it means the arrow points to the front of the vehicle.



Arrows in an illustration that are similar to these indicate movement or action.



Arrows in an illustration that are similar to these call attention to an item in the illustration.

Air bag warning label:



"NEVER use a rearward facing child restraint on a seat protected by an ACTIVE AIRBAG in front of it, DEATH or SERIOUS INJURY to the CHILD can occur."

Be sure to read "Air bag warning label" (P.1-21).

BATTERY DISPOSAL

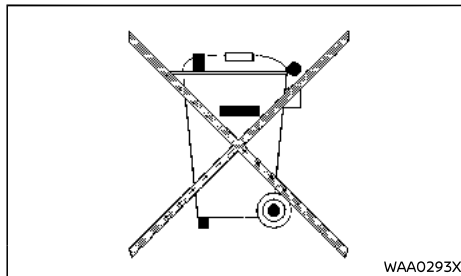

CAUTION:

An improperly disposed battery can harm the environment. Always confirm local regulations for battery disposal.

Examples of the batteries that the vehicle contains:

- Remote controller battery (for Intelligent Key and/or Remote keyless entry system)

© 2020 NISSAN MOTOR CO., LTD.

Table of Contents

Illustrated table of contents	0
Safety – seats, seat belts and supplemental restraint system	1
Instruments and controls	2
Pre-driving checks and adjustments	3
Monitor, heater and air conditioner, and audio system	4
Starting and driving	5
In case of emergency	6
Appearance and care	7
Maintenance and do-it-yourself	8
Technical information	9
Index	10

0 Illustrated table of contents



Seats, seat belts and Supplemental Restraint System (SRS)	0-2	Instrument panel	0-7
Exterior front	0-3	Meters and gauges	0-8
Exterior rear	0-4	Engine compartment	0-10
Passenger compartment	0-5	BR10 HS engine model	0-10
Cockpit	0-6	HRAODET engine model	0-11

SEATS, SEAT BELTS AND SUPPLEMENTAL RESTRAINT SYSTEM (SRS)

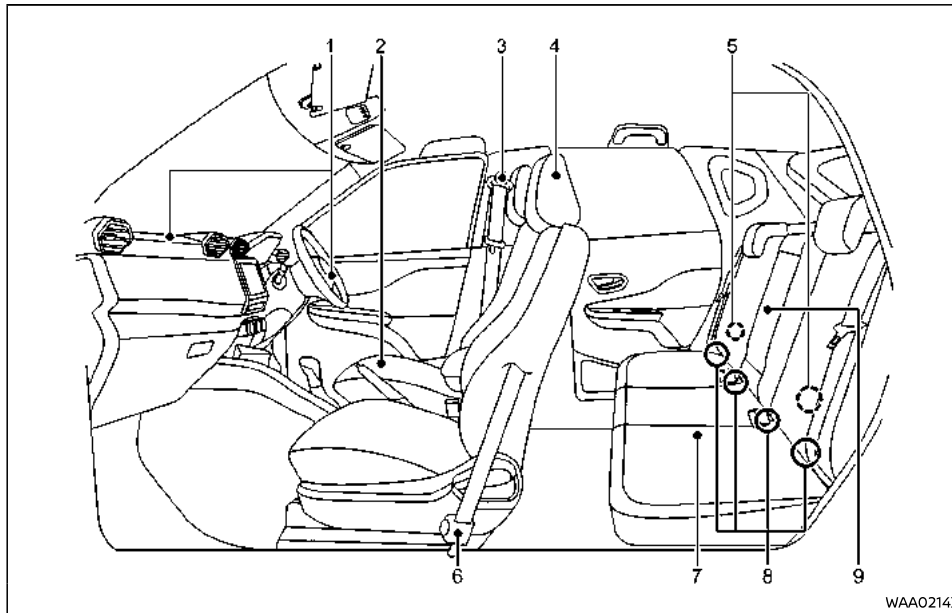

1. Supplemental front-impact air bags (P.1-19)

2. Front seats (P.1-2)

3. Seat belts (P.1-6)

4. Head restraints (P.1-4)

5. Child restraint anchor points (for top tether strap child restraint) (P.1-15)

6. Pre-tensioner seat belt system (P.1-24)

7. Rear seats (P.1-3)

— Child restraints (P.1-10)

8. ISOFIX child restraint system* (P.1-14)

9. Rear armrest* (P.1-4)

*: if equipped

EXTERIOR FRONT

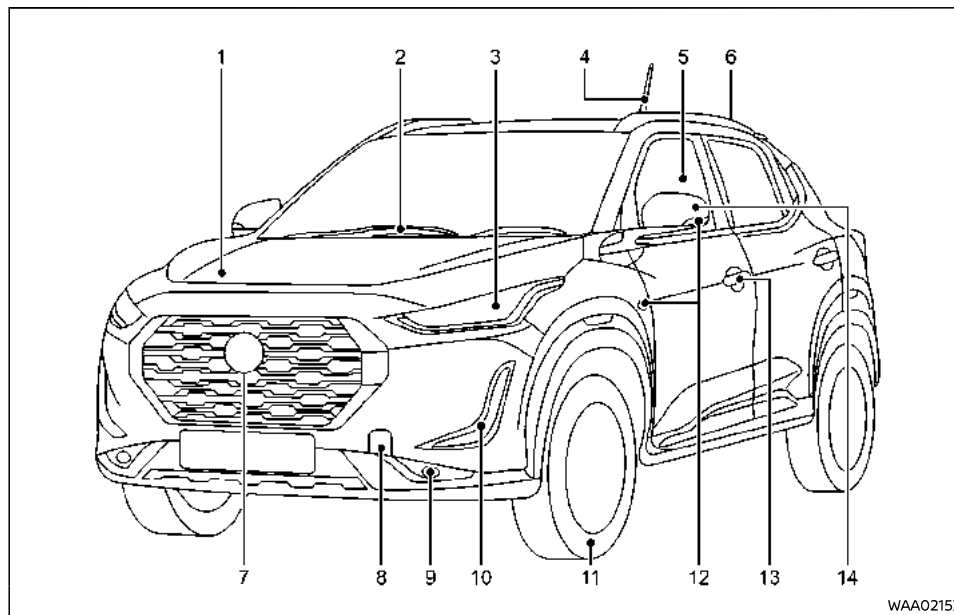

- | | |
|--|--|
| <ol style="list-style-type: none"> 1. Engine hood (P.3-14) 2. Windshield wiper and washer <ul style="list-style-type: none"> — Switch operation (P.2-22) — Blade replacement (P.8-15) — Window washer fluid (P.8-16) 3. Headlights and turn signal lights (P.2-20) 4. Antenna (P.4-37) 5. Power windows (P.2-24) 6. Roof rack (P.2-29) | <ol style="list-style-type: none"> 7. Front view camera* (P.4-7) 8. Recovery hook (P.6-10) 9. Fog lights* (P.2-22) 10. Clearance light/daytime running light* (P.2-20) 11. Tires <ul style="list-style-type: none"> — Specifications (P.9-6) — Tires and wheels (P.8-28, P.9-6) — Flat tire (P.6-2) — Tire placard (P.9-8) |
|--|--|

- Tire Pressure Monitoring System (TPMS)* (P.2-11, P.5-3)
 - 12. Side turn signal light (on the front fender or the outside rearview mirror) (P.2-21)
 - 13. Doors
 - Keys (P.3-2)
 - Door locks (P.3-3)
 - Remote keyless entry system* (P.3-5)
 - Intelligent Key system* (P.3-6)
 - Security system* (P.3-13)
 - 14. Outside rearview mirrors (P.3-18)
 - Side view camera* (P.4-7)
- *: if equipped

EXTERIOR REAR

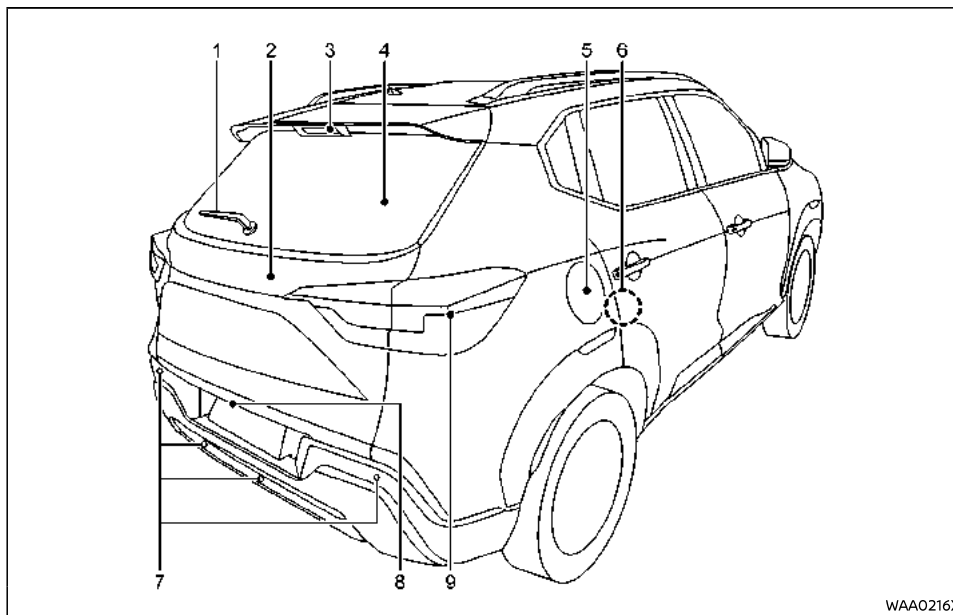

- | | |
|--|---|
| 1. Rear window wiper and washer
— Switch operation (P.2-23)
— Window washer fluid (P.8-16) | 6. Child safety rear door lock (P.3-4) |
| 2. Back door (P.3-15)
— Intelligent Key system* (P.3-6) | 7. Parking sensor (sonar) system (P.5-22) |
| 3. High-mounted stop light (P.8-25) | 8. Rearview camera* (P.4-2, P.4-7) |
| 4. Rear window defogger (P.2-23) | 9. Rear combination lights (P.8-25) |
| 5. Fuel-filler lid (P.3-17)
— Fuel information (P.9-4) | *: if equipped |

PASSENGER COMPARTMENT

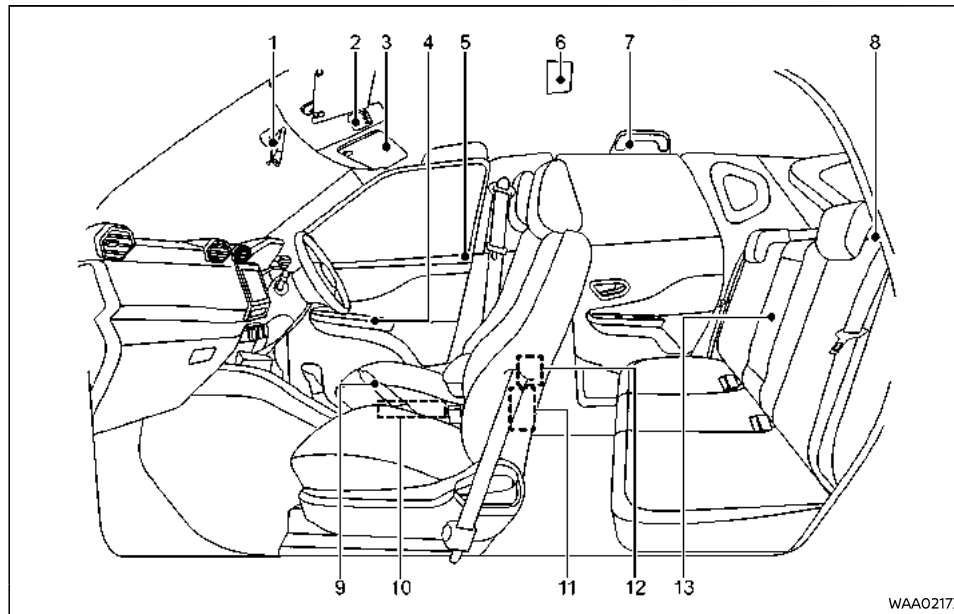

- | | |
|--|--|
| 1. Inside rearview mirror (P.3-18) | 7. Coat hook (P.2-28) |
| 2. Front room light (P.2-30)/front map light (P.2-30) | 8. Luggage room
— Storage (P.2-26)
— Luggage hooks (P.2-28)
— Cargo cover* (P.2-27)
— Spare tire (P.6-2) |
| 3. Sun visors (P.2-29, P.3-19) | 9. Parking brake (P.3-19) |
| 4. Door armrest
— Power window switch (P.2-24)
— Outside rearview mirror remote control switch (driver's side)* (P.3-18) | 10. Fuel-filler lid opener lever (P.3-17) |
| 5. Inside door lock knob (P.3-4) | 11. Power outlet* (P.2-25) |
| 6. Rear room light (P.2-30) | |

12. Rear ventilators* (P.4-14)
 13. Rear armrest* (P.1-4)
 — Rear cup holders (P.2-27)
 *: if equipped

COCKPIT

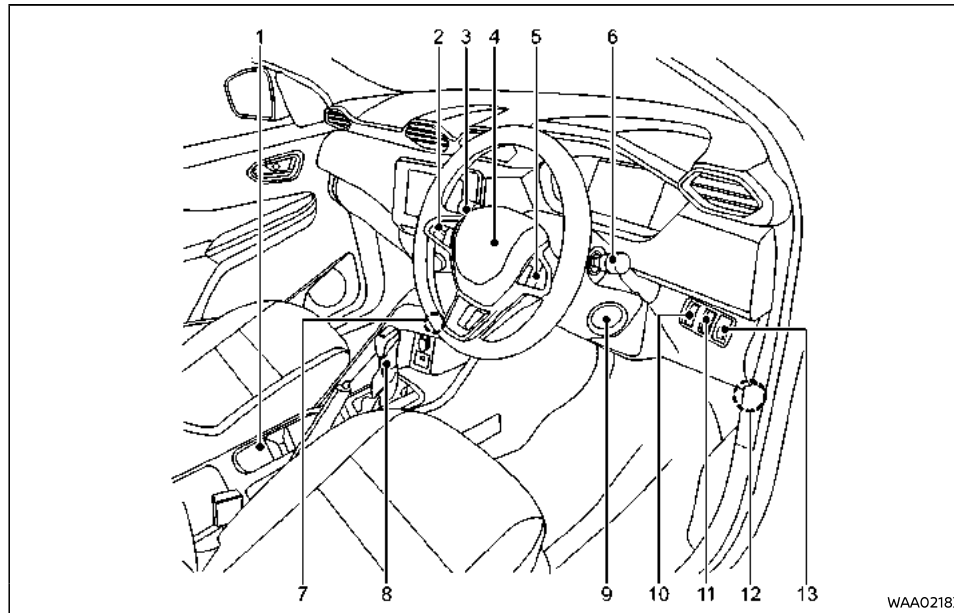

- | | |
|---|---|
| <ol style="list-style-type: none"> 1. Cup holders (P.2-26) 2. Steering-wheel mounted controls (left-side)* <ul style="list-style-type: none"> — Audio system* (P.4-28) or Multimedia system* (P.4-32.) 3. Wiper and washer switch (P.2-22) 4. Steering wheel <ul style="list-style-type: none"> — Power steering (P.5-23) — Horn (P.2-23) — Driver's supplemental front-impact air bag (P.1-19) | <ol style="list-style-type: none"> 5. Steering-wheel mounted controls (right-side)* <ul style="list-style-type: none"> — Audio system* (P.4-28) — Cruise control switches* (P.5-17) — Trip computer switch (for vehicle information display (type A))* (P.2-16) 6. Headlight and turn signal switch (P.2-20)/ Fog light switch* (P.2-22) 7. Push-button ignition switch (models with Intelligent Key system) (P.5-7) |
|---|---|

8. Shift lever
 - Continuously Variable Transmission (CVT) (P.5-10)
 - Manual Transmission (MT) (P.5-13)
 9. Ignition switch (models without Intelligent Key system) (P.5-6)
 10. Vehicle Dynamic Control (VDC) OFF switch* (P.5-15)
 11. Cruise control MAIN switch* (P.5-17)
 12. Hood lock release handle (P.3-15)
 13. Headlight aiming control switch (P.2-21)
- *: if equipped

INSTRUMENT PANEL

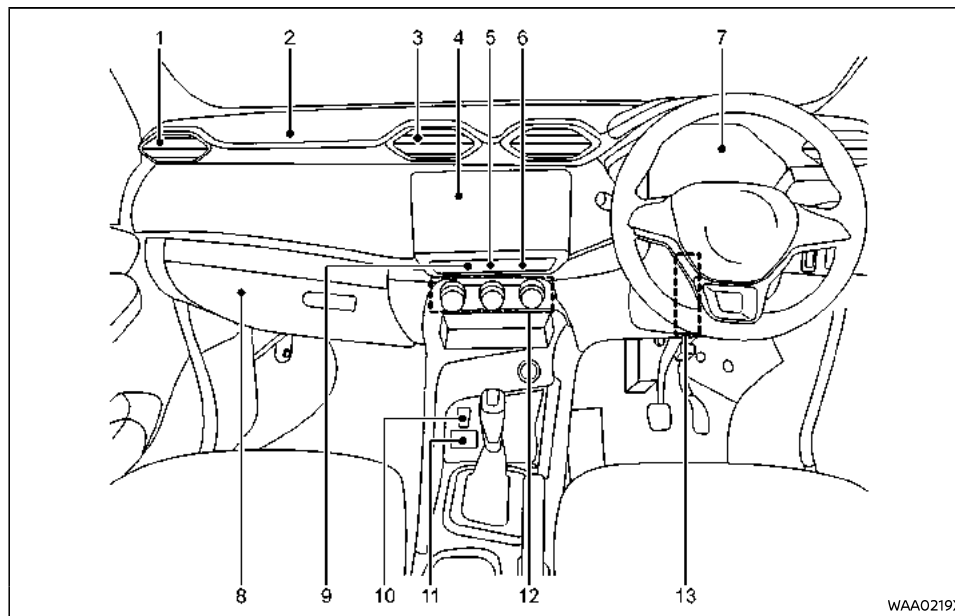

- | | |
|--|--|
| 1. Side ventilator (P.4-13) | 7. Meters and gauges (P.2-4) |
| 2. Front passenger's supplemental front-impact air bag (P.1-19) | 8. Glove box (P.2-26) |
| 3. Center ventilator (P.4-13) | 9. Defogger switch (P.2-23) |
| 4. Audio system* (P.4-19) or Multimedia system* (P.4-31) | 10. Power outlet (P.2-25) |
| — Rear view monitor* (P.4-2) | 11. USB (Universal Serial Bus) connection port* (P.4-32) |
| — Around View Monitor* (P.4-7) | 12. Heater and air conditioner control (P.4-14) |
| 5. Hazard indicator flasher switch (P.6-2) | 13. Tilting steering wheel lock lever (P.3-17) |
| 6. Power door lock switch* (P.3-4) or inside back door opener switch* (P.3-16) | *: if equipped |

METERS AND GAUGES

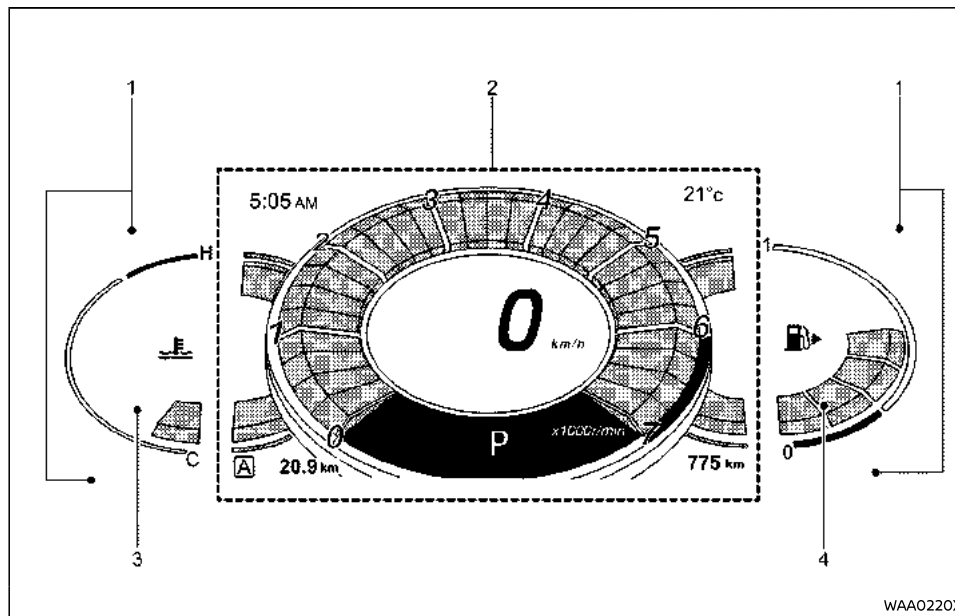

Type A

- | | |
|---|---|
| <ol style="list-style-type: none"> 1. Warning and indicator lights (P.2-9) 2. Vehicle information display (P.2-15) <ul style="list-style-type: none"> – Speedometer (P.2-5) – Tachometer (P.2-6) – Odometer/trip odometer/distance to empty (P.2-6) – Trip computer (P.2-16) – Clock and outside air temperature (P.2-18) – Warning and indicator lights (P.2-9) | <ul style="list-style-type: none"> – Gear shift indicator* (P.5-14) – Continuously Variable Transmission (CVT) position indicator* (P.2-8) – Cruise control* (P.5-17) – Pop up warnings (P.2-16) <ol style="list-style-type: none"> 3. Engine coolant temperature gauge (P.2-7) 4. Fuel gauge (P.2-7) <p>*: if equipped</p> |
|---|---|

O-8 Illustrated table of contents

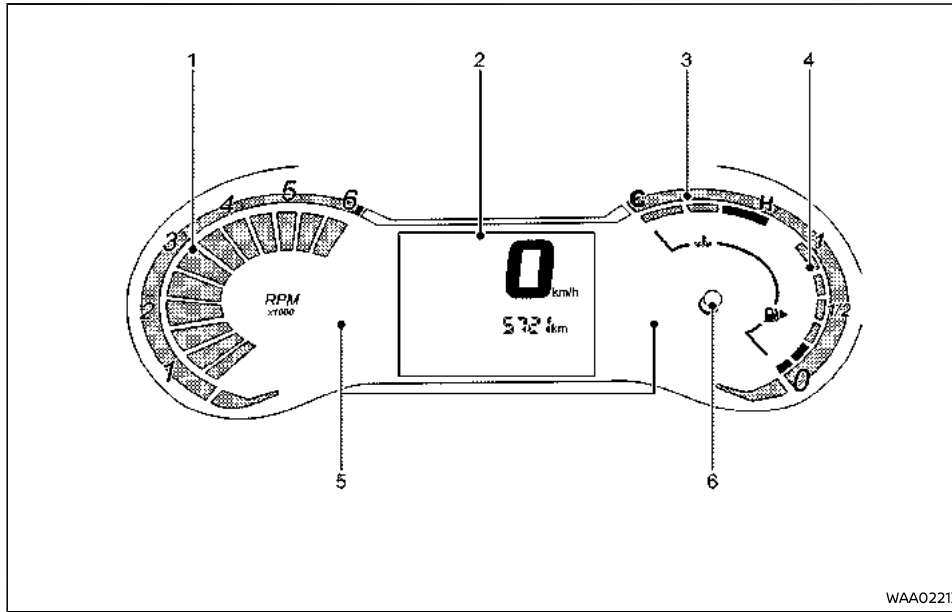

WAA0221X

Type B

- | | |
|--|---|
| <ol style="list-style-type: none"> 1. Tachometer (P.2-6) 2. Vehicle information display (P.2-18) <ul style="list-style-type: none"> – Speedometer (P.2-5) – Odometer/trip odometer/distance to empty (P.2-6) – Trip computer (P.2-19) – Gear shift indicator* (P.5-14) – Continuously Variable Transmission (CVT) position indicator* (P.2-8) 3. Engine coolant temperature gauge (P.2-7) | <ol style="list-style-type: none"> 4. Fuel gauge (P.2-7) 5. Warning and indicator lights (P.2-9) 6. Trip computer mode switch (P.2-19) <p>*: if equipped</p> |
|--|---|

ENGINE COMPARTMENT

BR10 HS ENGINE MODEL

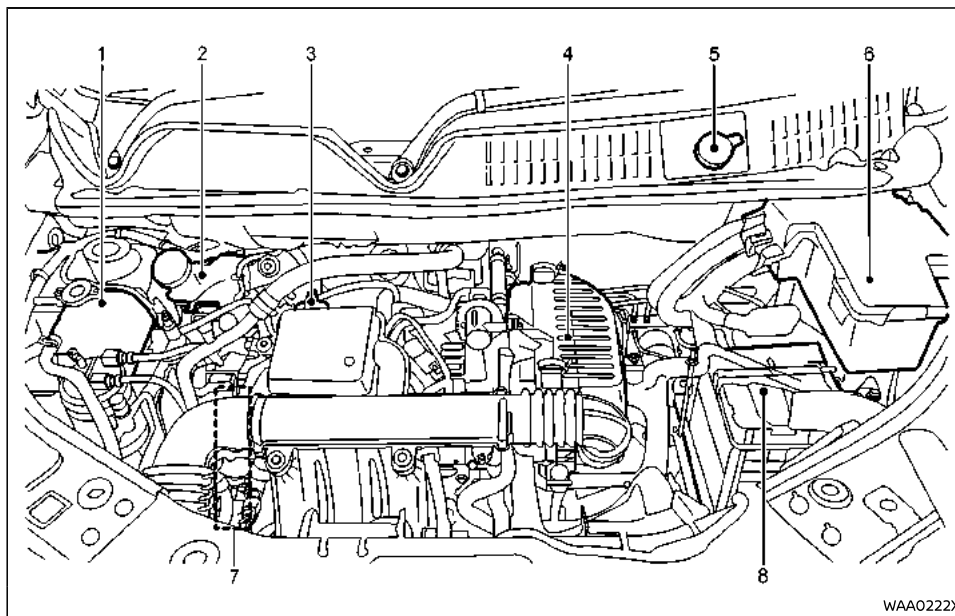

- | | |
|---|--|
| 1. Engine coolant reservoir (P.8-6) | 7. Engine drive belt location (P.8-10) |
| 2. Brake and clutch fluid reservoir (P.8-12, P.8-13) | 8. Battery (P.8-17) |
| 3. Engine oil filler cap (P.8-8)
— Engine oil dipstick (P.8-8) | |
| 4. Air cleaner (P.8-14) | |
| 5. Window washer fluid reservoir (P.8-16) | |
| 6. Fuse/fusible link holders (P.8-19) | |

O-10 **Illustrated table of contents**

HRAODET ENGINE MODEL

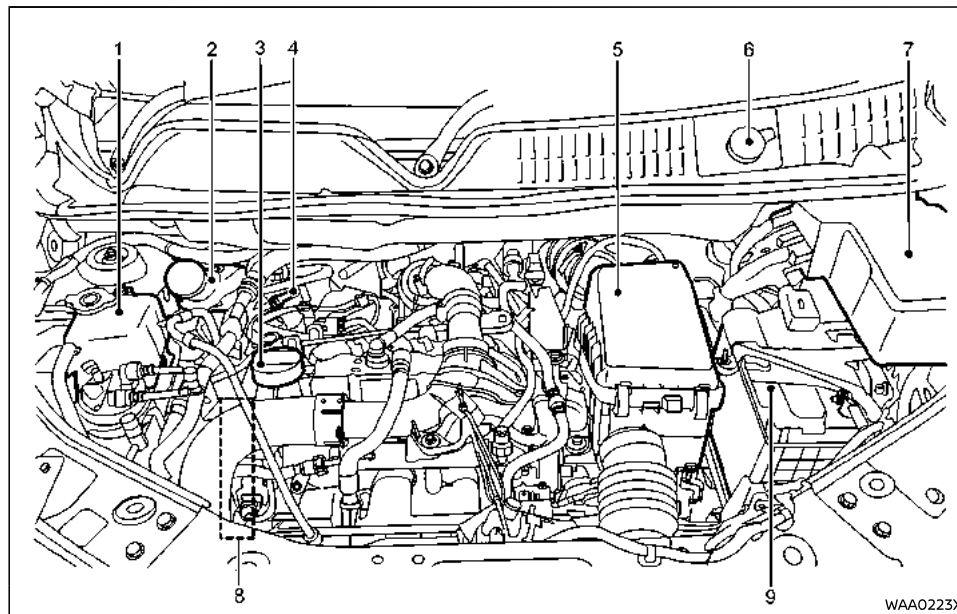

- | | |
|---|--|
| 1. Engine coolant reservoir (P.8-6) | 8. Engine drive belt location (P.8-10) |
| 2. Brake and clutch* fluid reservoir (P.8-12, P.8-13) | 9. Battery (P.8-17) |
| 3. Engine oil filler cap (P.8-8) | *: For Manual Transmission (MT) Model |
| 4. Engine oil dipstick (P.8-8) | |
| 5. Air cleaner (P.8-14) | |
| 6. Window washer fluid reservoir (P.8-16) | |
| 7. Fuse/fusible link holders (P.8-19) | |

MEMO

0-12 **Illustrated table of contents**

1 Safety — seats, seat belts and supplemental restraint system

Seats	1-2	Child restraints	1-10
Front seats	1-2	Precautions on child restraint usage	1-10
Rear seats	1-3	Universal child restraints for front seat and rear seats	1-11
Armrest (if equipped)	1-4	ISOFIX child restraint system (if equipped)	1-14
Head restraints	1-4	Child restraint anchorage (if equipped)	1-15
Adjustable head restraint components	1-4	Child restraint installation using ISOFIX (if equipped)	1-15
Non-adjustable head restraint components	1-4	Child restraint installation using three-point type seat belt	1-17
Remove	1-5	Supplemental Restraint System (SRS)	1-19
Install	1-5	Precautions on Supplemental Restraint System (SRS)	1-19
Adjust	1-5	Supplemental air bag systems	1-22
Seat belts	1-6	SRS air bag deployment conditions	1-23
Precautions on seat belt usage	1-6	Pre-tensioner seat belt system	1-24
Child safety	1-8	Repair and replacement procedure	1-25
Pregnant women	1-8	Automatic Collision Notification (ACN) (if equipped)	1-25
Injured persons	1-9		
Center mark on seat belts	1-9		
Three-point type seat belts	1-9		
Two-point type seat belts	1-10		
Seat belt maintenance	1-10		



SEATS

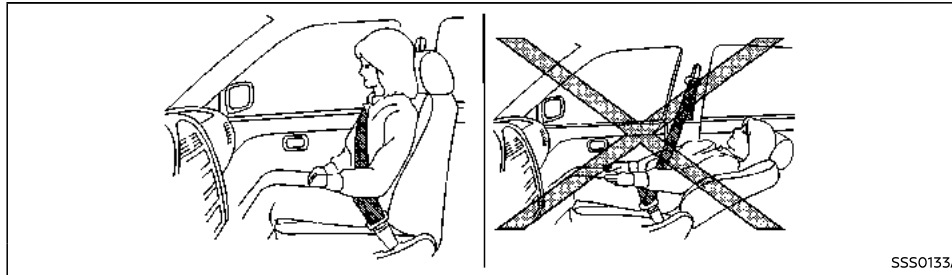

WARNING:

- Do not drive and/or ride in the vehicle with the seatback reclined. This can be dangerous. The shoulder belt will not be properly against the body. In an accident, you and your passengers could be thrown into the shoulder belt and receive neck or other serious injuries. You and your passengers could also slide under the lap belt and receive serious injuries.
- For the most effective protection while the vehicle is in motion, the seatback should be upright. Always sit well back and upright in the seat and adjust the seat belt properly. (See "Seat belts" (P.1-6).)
- Do not leave children unattended inside the vehicle. They could unknowingly activate switches or controls. Unattended children could become involved in serious accidents.
- To help avoid risk of injury or death through unintended operation of the vehicle and/or its systems, do not leave children, people who require the assis-

tance of others or pets unattended in your vehicle. Additionally, the temperature inside a closed vehicle on a warm day can quickly become high enough to cause a significant risk of injury or death to people and pets.

CAUTION:

When adjusting the seat positions, be sure not to contact any surrounding parts to avoid possible injuries or damages.

FRONT SEATS

WARNING:

Do not adjust the driver's seat while driving so that full attention may be given to vehicle operation.

Manual seat adjustment

WARNING:

After adjusting a seat, gently shake the seat to confirm that the seat is locked securely. If the seat is not locked securely, it may move suddenly and could cause the loss of control of the vehicle.

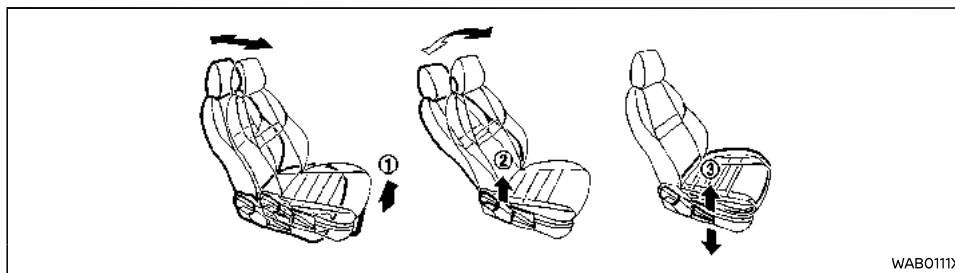

WAB0111X

Forward and backward:

1. Pull up the adjusting lever ①.
2. Slide the seat to the desired position.
3. Release the adjusting lever to lock the seat in position.

Reclining:

1. Pull up the adjusting lever ②.
2. Tilt the seatback to the desired position.
3. Release the adjusting lever to lock the seatback in position.

The reclining feature allows the adjustment of the seatback for occupants of different sizes to help obtain the proper seat belt fit. (See "Seat belts" (P.1-6).)

The seatback may be reclined to allow occupants to rest when the vehicle is parked.

Seat lifter (if equipped):

Pull up or push down the adjusting lever ③ to adjust the seat height until the desired position is achieved.

REAR SEATS

Folding

⚠ WARNING:

- **Never allow anyone to ride in the luggage area. Use of these areas by passengers without proper restraints could result in serious injury in an accident or sudden stop.**
- **Do not fold down the rear seats when occupants are in the rear seat area or any luggage is on the rear seats.**
- **Properly secure all luggage to help prevent it from sliding or shifting. Do not place luggage higher than the seatback.**
- **Head restraints should be adjusted properly as they may provide significant protection against whiplash injury. Always replace and adjust them properly if they have been removed for any reason.**

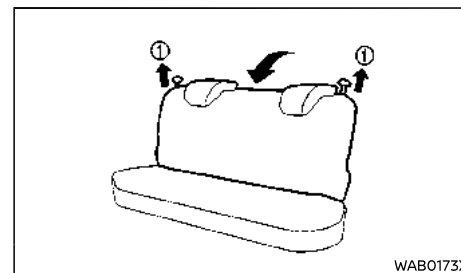

WAB0173X

Type A

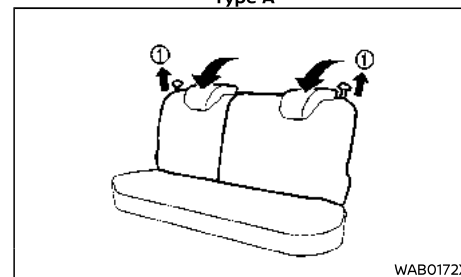

WAB0172X

Type B

To fold the seatback, pull the knob ①.

To return the seatback to the seating position, lift up the seatback and push it to the upright position until it is latched.

NOTE:

When returning the seatback to the seating position, make sure that the seat belts are placed in front of the seatback.

⚠ CAUTION:

- **When loading the luggage in the luggage area, be careful not to scratch or damage the seat belt.**

- When operating the seatback, be careful not to scratch or damage the seat belt.
- When returning the seatback to the upright position, be certain they are completely secured in the latched position. If they are not completely secured, passengers may be injured in an accident or sudden stop.

ARMREST (if equipped)

Rear

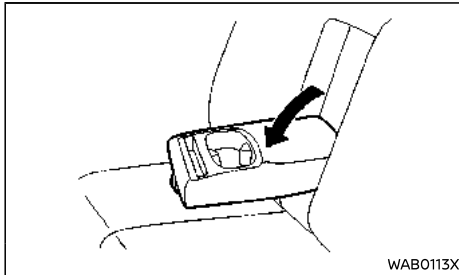

Pull the armrest down as shown.

HEAD RESTRAINTS



WARNING:

Head restraints supplement the other vehicle safety systems. They may provide additional protection against injury in certain rear end collisions. Adjustable head restraints must be adjusted properly, as specified in this section. Check the adjustment after someone else uses the seat. Do not attach anything to the head restraint stalks or remove the head restraint. Do not use the seat if the head restraint has been removed. If the head restraint was removed, reinstall and properly adjust the head restraint before an occupant uses the seating position. Failure to follow these instructions can reduce the effectiveness of the head restraint. This may increase the risk of serious injury or death in a collision.

- Your vehicle is equipped with a head restraint that may be integrated, adjustable or non-adjustable.
- Adjustable head restraints have multiple notches along the stalk to lock them in a desired adjustment position.
- The non-adjustable head restraints have a single locking notch to secure them to the seat frame.
- Proper Adjustment:
 - For the adjustable type, align the head restraint so the center of your ear is approximately level with the center of the head restraint.
 - If your ear position is still higher than the recommended alignment, place the head restraint at the highest position.
- If the head restraint has been removed, ensure that it is reinstalled and locked in place before riding in that designated

seating position.

ADJUSTABLE HEAD RESTRAINT COMPONENTS

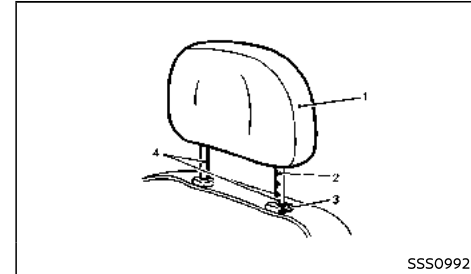

1. Removable head restraint
2. Multiple notches
3. Lock knob
4. Stalks

NON-ADJUSTABLE HEAD RESTRAINT COMPONENTS

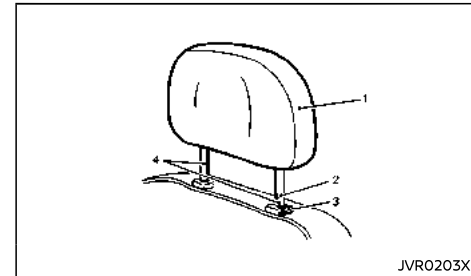

1. Removable head restraint

2. Single notch
3. Lock knob
4. Stalks

REMOVE

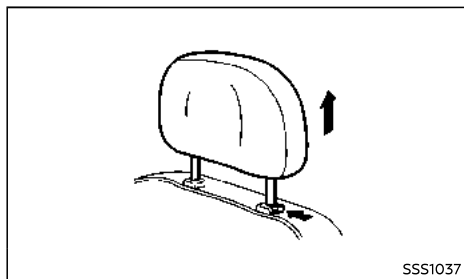

Use the following procedure to remove the head restraint.

1. Pull the head restraint up to the highest position.
2. Push and hold the lock knob.
3. Remove the head restraint from the seat.
4. Store the head restraint properly in a secure place so it is not loose in the vehicle.
5. Reinstall and properly adjust the head restraint before an occupant uses the seating position.

INSTALL

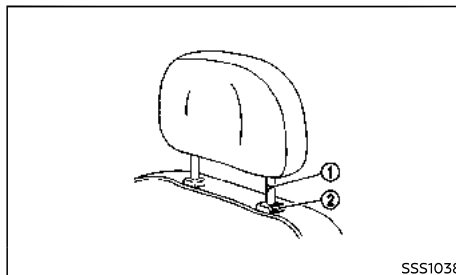

1. Align the head restraint stalks with the holes in the seat. Make sure that the head restraint is facing the correct direction. The stalk with the adjustment notch ① must be installed in the hole with the lock knob ②.
2. Push and hold the lock knob and push the head restraint down.
3. Properly adjust the head restraint before an occupant uses the seating position.

ADJUST

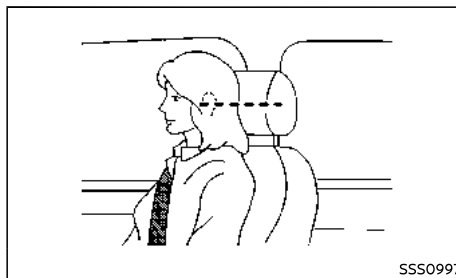

For adjustable head restraint

Adjust the head restraint so the center is level with the center of your ears. If your ear position is still higher than the recommended alignment, place the head restraint at the highest position.

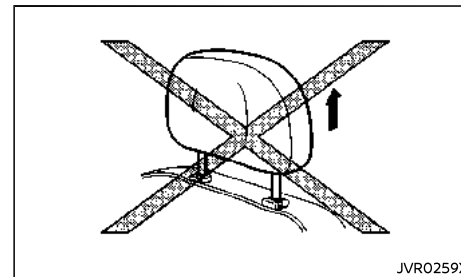

For non-adjustable head restraint

Make sure the head restraint is positioned from the stored position or any non-latch position so the lock knob is engaged in the notch before riding in that designated seating position.

Raise

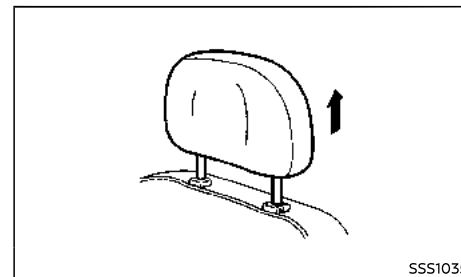

To raise the head restraint, pull it up.

SEAT BELTS

Make sure the head restraint is positioned from the stored position or any non-latch position so the lock knob is engaged in the notch before riding in that designated seating position.

Lower

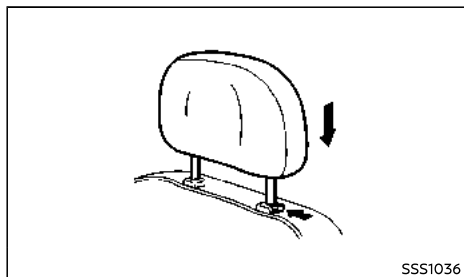

To lower, push and hold the lock knob and push the head restraint down.

Make sure the head restraint is positioned so the lock knob is engaged in the notch before riding in that designated seating position.

PRECAUTIONS ON SEAT BELT USAGE

If you are wearing the seat belt properly adjusted and sitting upright and well back in the seat, chances of being injured or killed in an accident and/or the severity of injury may be greatly reduced. NISSAN strongly encourages you and all of your passengers to buckle up every time you drive, even if your seating position includes the supplemental air bag systems.

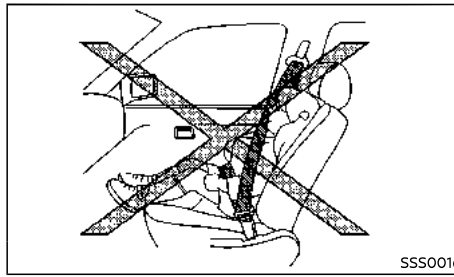
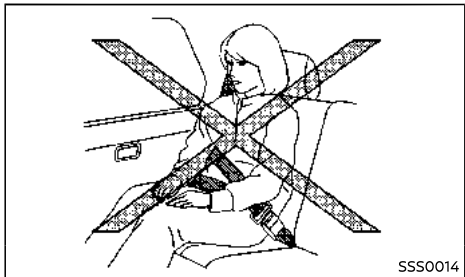
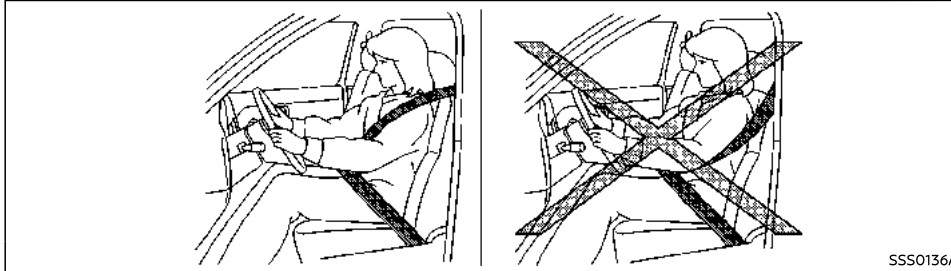
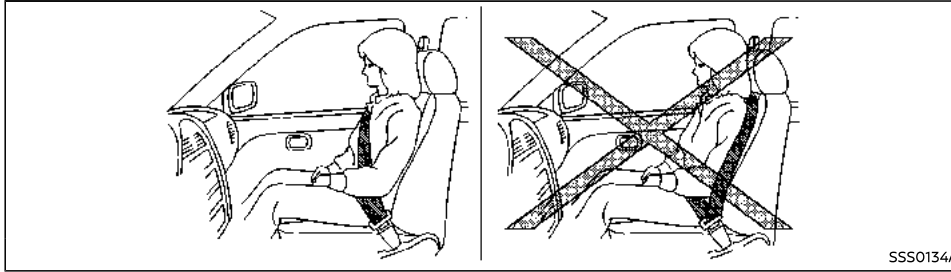

WARNING:

- Seatbelts are designed to bear upon the bony structure of the body, and should be worn low across the front of the pelvis or the pelvis, chest and shoulders, as applicable; wearing the lap section of the belt across the abdominal area must be avoided. Serious injury may occur if a seat belt is not worn properly.
- Position the lap belt as low and snug as possible around the hips, not the waist. A lap belt worn too high could increase the risk of internal injuries in an accident.
- Do not allow more than one person to use the same seat belt. Each belt assembly must only be used by one occupant; it is dangerous to put a belt around a child being carried on the occupant's lap.
- Never carry more people in the vehicle than there are seat belts.
- Never wear seat belts inside out. Belts should not be worn with straps twisted. Doing so may reduce their effectiveness.
- Seatbelts should be adjusted as firmly as possible, consistent with comfort, to provide the protection for which they have been designed. A slack belt will greatly reduce the protection afforded to the wearer.
- Every person who drives or rides in this vehicle should use a seat belt at all times. Children should be properly restrained in the rear seat and, if appropriate, in a child restraint system.
- Do not put the belt behind your back or under your arm. Always route the shoulder belt over your shoulder and across your chest. The belt should be

away from your face and neck, but not falling off your shoulder. Serious injury may occur if a seat belt is not worn properly.

- No modifications or additions should be made by the user which will either prevent the seat belt adjusting devices from operating to remove slack, or prevent the seat belt assembly from being adjusted to remove slack.
- Care should be taken to avoid contamination of the webbing with polishes, oils and chemicals, and particularly battery acid. Cleaning may safely be carried out using mild soap and water. The belt should be replaced if webbing becomes frayed, contaminated or damaged.
- All seat belt assemblies including retractors and attaching hardware should be inspected after any collision by a NISSAN dealer. NISSAN recommends that all seat belt assemblies in use during a collision be replaced unless the collision was minor and the belts show no damage and continue to operate properly. Seat belt assemblies not in use during a collision should also be inspected and, when necessary, replaced if either damage or improper operation is noted.
- It is essential to replace the entire assembly after it has been worn in a severe impact even if damage to the assembly is not obvious.
- Once the pre-tensioner seat belt has activated, it cannot be reused. It must be replaced together with the retractor. Contact a NISSAN dealer.
- Removal and installation of the pre-tensioner seat belt system components

should be done by a NISSAN dealer.

CHILD SAFETY



WARNING:

- Infants and children need special protection. The vehicle's seat belts may not fit them properly. The shoulder belt may come too close to the face or neck. The lap belt may not fit over their small hipbones. In an accident, an improperly fitted seat belt could cause serious or fatal injury.
- Always use an appropriate child restraint system.

Children need adults to help protect them. They need to be properly restrained. The proper restraint depends on the child's size.

Infants and small children

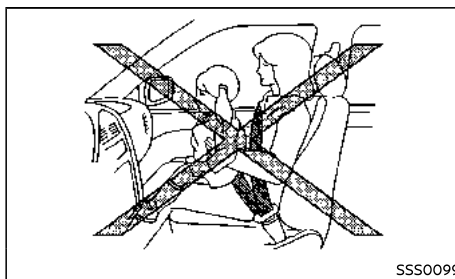

NISSAN recommends that infants and small children be seated in a child restraint system. You should choose a child restraint system that fits your vehicle and the child, and always follow the manufacturer's instructions for installation and use.

Large children



WARNING:

- Never allow children to stand or kneel on any seats.
- Never allow children in the luggage area while the vehicle is moving. A child could be seriously injured in an accident or sudden stop.

Children who are too large for a child restraint system should be seated and restrained by the seat belts that are provided.

If the child's seating position has a shoulder belt that fits close to the face or neck, the use of a booster seat (commercially available) may help overcome this. The booster seat should raise the child so that the shoulder belt is properly positioned across the top, middle portion of the shoulder and the lap belt is low on the hips. The booster seat should also fit the vehicle seat. Once the child has grown so that the shoulder belt is no longer on or near the face or neck of the child, use the shoulder belt without the booster seat. In addition, there are many types of child restraint systems available for larger children that should be used for maximum protection.

PREGNANT WOMEN

NISSAN recommends that pregnant women use seat belts. The seat belt should be worn snug, and always position the lap belt as low as possible around the hips, not the waist. Place the shoulder belt over your shoulder and across your chest. Never run the lap/shoulder belt over your abdominal area. Contact your doctor for specific recommendations.

INJURED PERSONS

NISSAN recommends that injured persons use seat belts. Contact your doctor for specific recommendations.

CENTER MARK ON SEAT BELTS

Selecting correct set of seat belts

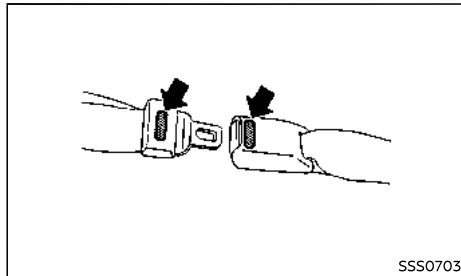

The center seat belt buckle and tongue are identified by the CENTER mark. The center seat belt tongue can be fastened only into the center seat belt buckle.

THREE-POINT TYPE SEAT BELTS

Fastening seat belts

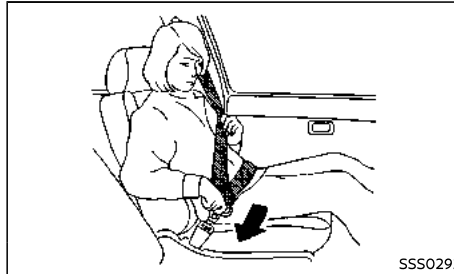

WARNING:

The seatback should not be in a reclined position any more than needed for comfort. Seat belts are most effective when the passenger sits well back and straight up in the seat.

1. Adjust the seat. (See "Seats" (P.1-2).)
2. Slowly pull the seat belt out of the retractor and insert the tongue into the buckle until you hear and feel the latch engage.
 - **The retractor is designed to lock during a sudden stop or on impact. A slow pulling motion permits the belt to move, and allows you some freedom of movement in the seat.**
 - **If the seat belt cannot be pulled from its fully retracted position, firmly pull the belt and release it. Then smoothly pull the belt out of the retractor.**

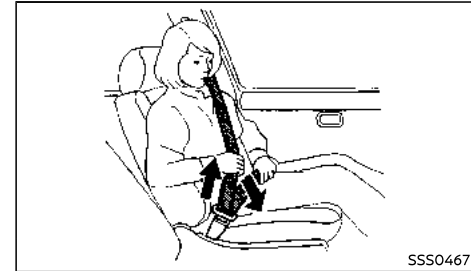

3. Position the lap belt portion low and snug on the hips as shown.
4. Pull the shoulder belt portion toward the retractor to take up extra slack. Be sure the shoulder belt is routed over your shoulder and is snug across your chest.

Unfastening seat belts

Push the button on the buckle. The seat belt automatically retracts.

Checking seat belt operation

Seat belt retractors are designed to lock seat belt movement:

- When the seat belt is pulled quickly from the retractor.
- When the vehicle slows down rapidly.

To increase your confidence in the seat belts, check the operation by grasping the shoulder belt and pulling forward quickly. The retractor should lock and restrict further belt movement. If the retractor does not lock during this check, contact a NISSAN dealer immediately.

TWO-POINT TYPE SEAT BELTS

Fastening seat belts

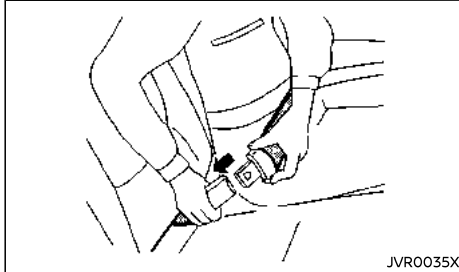

1. Insert the tongue into the buckle until you hear and feel the latch engage.

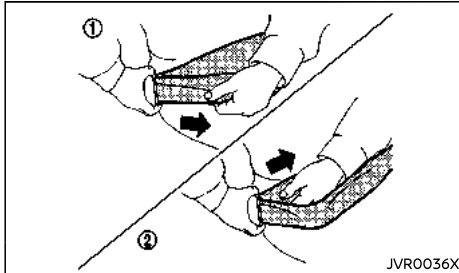

2. Adjust the seat belt length. To shorten, hold the tongue and pull the upper belt as illustrated ①. To lengthen, hold the tongue and pull the under belt as illustrated ②.

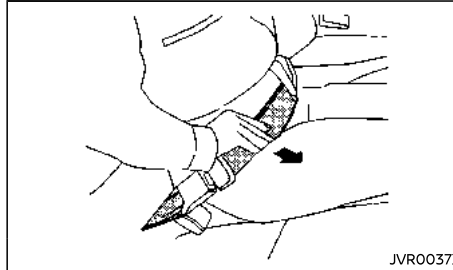

3. Position the lap belt portion low and snug on the hips as shown.

Unfastening seat belts

Push the button on the buckle.

SEAT BELT MAINTENANCE

Periodically check that the seat belt and all the metal components, such as buckles, tongues, retractors, flexible wires and anchors, work properly. If loose parts, deterioration, cuts or other damage on the seat belt webbing is found, the entire seat belt assembly should be replaced.

If dirt builds up in the shoulder belt guide of the seat belt anchors, the seat belts may retract slowly. Wipe the shoulder belt guide with a clean, dry cloth.

To clean the seat belt webbing, apply a mild soap solution or any solution recommended for cleaning upholstery or carpet. Then wipe with a cloth and allow the seat belts to dry in the shade. Do not allow the seat belts to retract until they are completely dry.

CHILD RESTRAINTS

PRECAUTIONS ON CHILD RESTRAINT USAGE

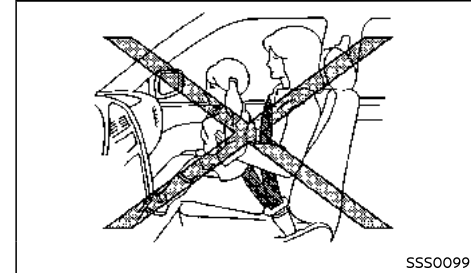

WARNING:

- **Infants and small children should always be placed in an appropriate child restraint while riding in the vehicle. Failure to use a child restraint can result in serious injury or death.**
- **Infants and small children should never be carried on your lap. It is not possible for even the strongest adult to resist the forces of a severe accident. The child could be crushed between the adult and parts of the vehicle. Also, do not put the same seat belt around both your child and yourself.**
- **NISSAN recommends that the child restraints be installed in the rear seat. According to accident statistics, children are safer when properly restrained in the rear seat than in the front seat.**
- **Improper use or improper installation of a child restraint can increase the risk or severity of injury for both the child and other occupants of the vehicle and can**

lead to serious injury or death in an accident.

- Follow all of the child restraint manufacturer's instructions for installation and use. When purchasing a child restraint, be sure to select one which will fit your child and vehicle. It may not be possible to properly install some types of child restraint in your vehicle.
- The direction of the child restraint, either front-facing or rear-facing, depends on the type of the child restraint and the size of the child. Refer to the child restraint manufacturer's instructions for details.
- Adjustable seatbacks should be positioned to ensure full contact between child restraint and seatback.
- After attaching a child restraint, test it before you place the child in it. Push it from side to side and tug it forward to make sure that is held securely in place. The child restraint should not move more than 25 mm (1 in). If the restraint is not secure, tighten the belt as necessary, or install the restraint in another seat and test it again.
- When the child restraint is not in use, keep it secured with the ISOFIX child restraint system (if equipped) or a seat belt to prevent it from being thrown around in case of a sudden stop or accident.
- Never install a rear-facing child restraint on the front passenger's seat when the front passenger's air bag is available. Supplemental front-impact air bags inflate with great force. A rear-facing child restraint could be struck by the supplemental front-impact air bags in an accident and could seriously injure or kill your

child.

- If the seat belt in the position where a child restraint is installed requires a locking device and if it is not used, injuries could result from a child restraint tipping over during normal vehicle braking or cornering.



CAUTION:

Remember that a child restraint left in a closed vehicle can become very hot. Check the seating surface and buckles before placing your child in a child restraint.

NISSAN recommends that infants and small children be seated in a child restraint. You should choose a child restraint that fits your vehicle and always follow the manufacturer's instructions for installation and use. In addition, there are many types of child restraints available for larger children that should be used for maximum protection.

UNIVERSAL CHILD RESTRAINTS FOR FRONT SEAT AND REAR SEATS

NOTE:

Universal child restraints approved to UN Regulation No.44 (UN R44) or UN Regulation No.129 (UN R129) are clearly marked "Universal".

When selecting any child restraint, keep the following points in mind:

- Choose a child restraint that complies with the UN R44 or UN R129.
- Place your child in the child restraint and check the various adjustments to be sure the child restraint is compatible with your child. Always follow all of the recommended procedures.
- Check the child restraint in your vehicle to be sure it is compatible with vehicle's seat belt system.
- Refer to the tables later in this section for a list of the recommended fitment positions and the approved child restraints for your vehicle.

Mass group of child seat

Mass group	Child's weight
Group 0	up to 10 kg
Group 0+	up to 13 kg
Group I	9 to 18 kg
Group II	15 to 25 kg
Group III	22 to 36 kg

Kind of child seats (example):

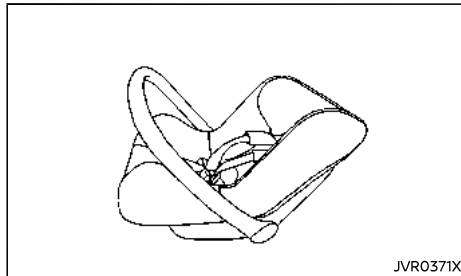

Child safety seat categories 0 and 0+

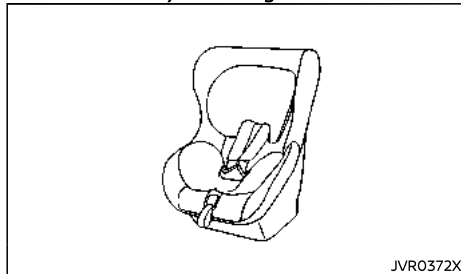

Child safety seat categories 0+ and I

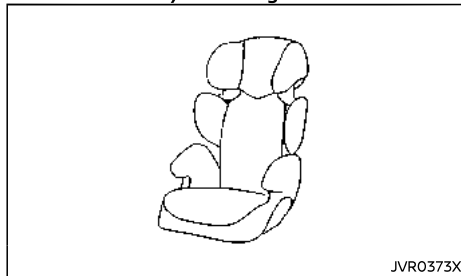

Child safety seat categories II and III

Approved child restraint positions (without ISOFIX)

The following restriction is applied when using child restraints varying by infants weight and installation position (without ISOFIX child restraint).

Mass group		Suitability		
		Front passenger seat	2nd row outer seat	2nd row center seat
0	<10 kg	X	U	X
0+	<13 kg	X	U	X
I	9 - 18 kg	UF*1*2	U*1	X
II	15 - 25 kg	UF*1*2	UF*1	X
III	22 - 36 kg	UF*1*2	UF*1	X

X: Not suitable for child restraint system.

U: Suitable for universal category child restraint system, approved for use in this mass group.

UF: Suitable for forward-facing universal category child restraint system approved for use in this mass group.

*1: If you install a child restraint system, remove and store the seat head restraint.

*2: If you install a child restraint system on the front passenger seat, set the front passenger's seatback to the most upright reclining position.

Approved child restraint positions (with ISOFIX)

The following restriction is applied when using child restraints varying by infants weight and installation position (ISOFIX child restraint).

Mass group			Suitability		
			Front passenger seat	2nd row outer seat	2nd row center seat
Carry-cot	F	ISO/L1	X	X	X
	G	ISO/L2	X	X	X
0 (<10 kg)	E	ISO/R1	X	IL	X
0+ (<13 kg)	E	ISO/R1	X	IL	X
	D	ISO/R2	X	IL	X
	C	ISO/R3	X	IL	X
I (9 - 18 kg)	D	ISO/R2	X	IL	X
	C	ISO/R3	X	IL	X
	B	ISO/F2	X	IUF*1	X
	B1	ISO/F2X	X	IUF*1	X
	A	ISO/F3	X	IUF*1	X
II (15-25 kg)	—	—	X	IL*1	X
III (22-36 kg)	—	—	X	IL*1	X

- X: Not suitable for installation of ISOFIX child restraint system (CRS) in these seating positions.
- IUF: Suitable for universal category forward facing child restraint system approved for use in this mass group.
- IL: Suitable for the particular ISOFIX category child restraint system (CRS) given in the following list or vehicle list of child seat manufacturer.
- *1: If you install a child restraint system, remove the seat head restraint.

List of recommended ISOFIX child restraints (if equipped)

	Front passenger seat	Rear outboard seat		Rear center seat
0 (<10 kg)	—	—		—
0+ (<13 kg)	—	Britax Baby Safe SHR Plus II ISOFIX Base	ISOFIX & Supported Leg Rearward facing	—
I (9 - 18 kg)	—	Maxi Cosi Milofix	ISOFIX & Strap/ Top tether Forward & Rearward facing	—
II (15 - 25 kg)	—	—	—	—
III (22 - 36 kg)	—	—	—	—

ISOFIX CHILD RESTRAINT SYSTEM (if equipped)

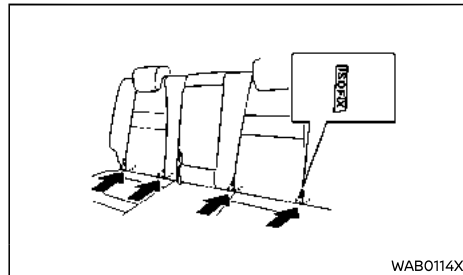

! WARNING:

- **ISOFIX child restraint system must be used only if there is ISOFIX label identification provided on the seat surface.**
- **If ISOFIX label on the seat surface is not present, DO NOT use the ISOFIX child**

restraint system.

Your vehicle is equipped with special anchor points that are used with ISOFIX child restraint systems.

ISOFIX lower anchor point locations

The ISOFIX anchor points are provided to install child restraints in the rear outboard seating positions only. **Do not attempt to install a child restraint in the center seating position using the ISOFIX anchors.**

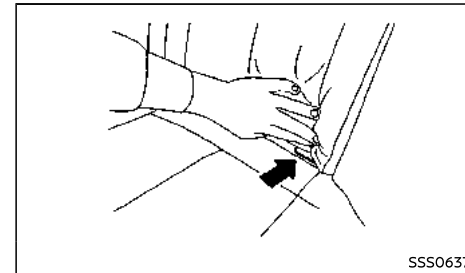

ISOFIX lower anchor location

The ISOFIX anchors are located as shown. A label is attached to the seatback to help you locate the ISOFIX anchors.

ISOFIX child restraint anchor attachments

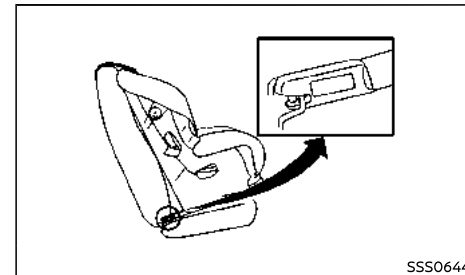

Anchor attachment

ISOFIX child restraints include two rigid attachments that can be connected to two anchors located in the seat. With this system, you do not have to use a vehicle seat belt to secure the child restraint. Check your child restraint for a label stating that it is compatible with the ISOFIX child restraints. This information may also be in the instructions provided by the child restraint manufacturer.

ISOFIX child restraints generally require the use of a top tether strap or other anti-rotation devices such as support legs. When installing ISOFIX child restraints, carefully read and follow the instructions in this manual and those supplied with the child restraints. (See "Child restraint installation using ISOFIX" (P.1-15).)

CHILD RESTRAINT ANCHORAGE (if equipped)

Your vehicle is designed to accommodate a child restraint system on the rear seat. When installing a child restraint system, carefully read and follow the instructions in this manual and those supplied with the child restraint system.

⚠ WARNING:

- Child restraint anchorages are designed to withstand only those loads imposed by correctly fitted child restraints. Under no circumstances are they to be used for adult seat belts, harnesses or for attaching other items or equipment to the vehicle. Doing so could damage the child restraint anchorages. The child restraint will not be properly installed using the damaged anchorage, and a child could be seriously injured or killed in a collision.
- The child restraint top tether strap may be damaged by contact with the cargo cover or items in the luggage area. Remove the cargo cover (if equipped) from the vehicle or secure it and any luggage. Your child could be seriously injured or killed in a collision if the top tether strap is damaged.

Anchorage location

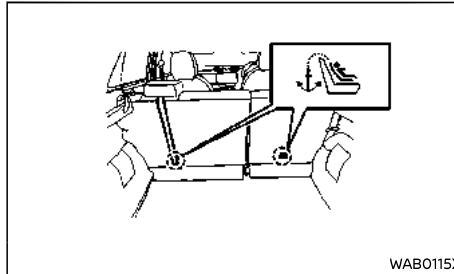

The anchor points are located as illustrated.

CHILD RESTRAINT INSTALLATION USING ISOFIX (if equipped)

⚠ WARNING:

- Attach ISOFIX child restraints only at the specified locations. For the ISOFIX lower anchor locations, see "ISOFIX child restraint system" (P.1-14). If a child restraint is not secured properly, your child could be seriously injured or killed in an accident.
- Do not install child restraints that require the use of a top tether strap to seating positions that do not have a top tether anchor.
- Do not secure a child restraint in the center rear seating position using the ISOFIX lower anchors. The child restraint will not be secured properly.
- Inspect the lower anchors by inserting your fingers into the lower anchor area and feeling to make sure there are no obstructions over the ISOFIX anchors,

such as seat belt webbing or seat cushion material. The child restraint will not be secured properly if the ISOFIX anchors are obstructed.

- Child restraint anchorages are designed to withstand only those loads imposed by correctly fitted child restraints. Under no circumstances are they to be used for adult seat belts, harnesses or for attaching other items or equipment to the vehicle. Doing so could damage the child restraint anchorages. The child restraint will not be properly installed using the damaged anchorage, and a child could be seriously injured or killed in a collision.

Installation on rear outboard seats

Front-facing:

Be sure to follow the manufacturer's instructions for the proper use of your child restraint. Follow these steps to install a front-facing child restraint on the rear outboard seats using ISOFIX:

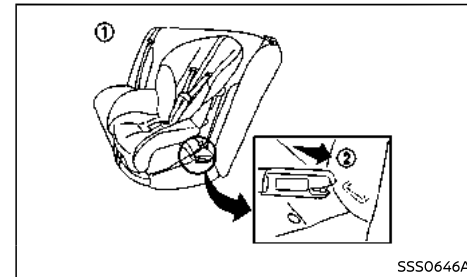

Front-facing: Steps 1 and 2

1. Position the child restraint on the seat ①.

2. Secure the child restraint anchor attachments to the ISOFIX lower anchors ②.
3. The back of the child restraint should be secured against the vehicle seat back. If necessary, remove the head restraint to obtain the correct child restraint fit. (See "Head restraints" (P.1-4).) If the head restraint is removed, store it in a secure place. Be sure to install the head restraint when the child restraint is removed. If the seating position does not have an adjustable head restraint and it is interfering with the proper child restraint fit, try another seating position or a different child restraint.

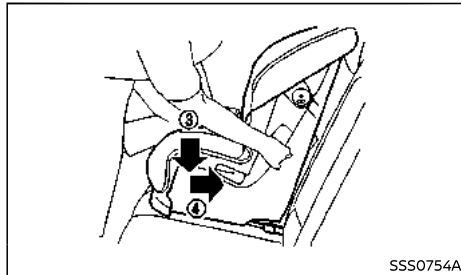

Front-facing: Step 4

4. Shorten the rigid attachment to have the child restraint firmly tightened; press downward ③ and rearward ④ firmly in the center of the child restraint with your knee to compress the vehicle seat cushion and seatback.
5. If the child restraint is equipped with a top tether strap, route the top tether strap and secure the tether strap to the tether anchor point. (See "Child restraint anchorage" (P.1-15).)

6. If the child restraint is equipped with other anti-rotation devices such as support legs, use them instead of the top tether strap following the child restraint manufacturer's instructions.

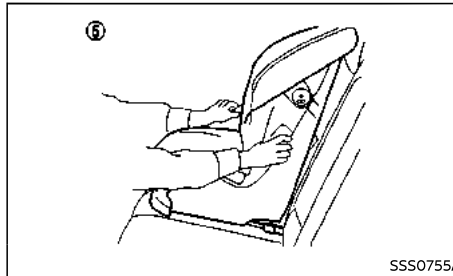

Front-facing: Step 7

7. Test the child restraint before you place the child in it ⑤. Push the child restraint from side to side and tug it forward to make sure that it is held securely in place.
8. Check to make sure that the child restraint is properly secured prior to each use. If the child restraint is loose, repeat steps 3 through 7.

Rear-facing:

Be sure to follow the manufacturer's instructions for the proper use of your child restraint. Follow these steps to install a rear-facing child restraint on the rear outboard seats using ISOFIX:

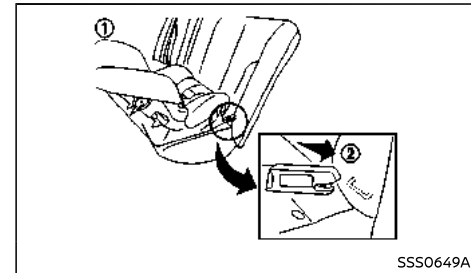

Rear-facing: Steps 1 and 2

1. Position the child restraint on the seat ①.
2. Secure the child restraint anchor attachments to the ISOFIX lower anchors ②.

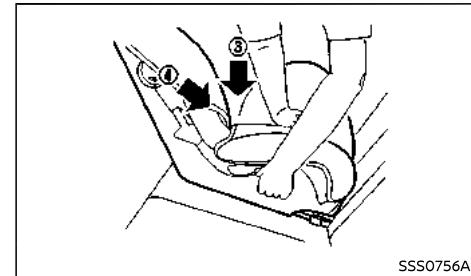

Rear-facing: Step 3

3. Shorten the rigid attachment to have the child restraint firmly tightened; press downward ③ and rearward ④ firmly in the center of the child restraint with your hand to compress the vehicle seat cushion and seatback.
4. If the child restraint is equipped with a top tether strap, route the top tether strap and secure the tether strap to the tether anchor point. (See "Child restraint anchorage" (P.1-15).)

- If the child restraint is equipped with other anti-rotation devices such as support legs, use them instead of the top tether strap following the child restraint manufacturer's instructions.

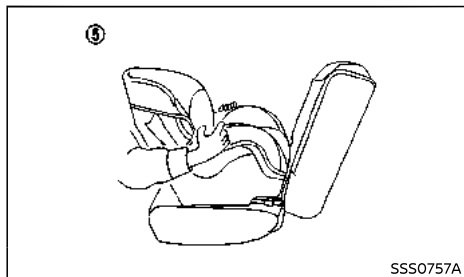

SSS0757A

Rear-facing: Step 6

- Test the child restraint before you place the child in it ⑤. Push the child restraint from side to side and tug it forward to make sure that it is held securely in place.
- Check to make sure that the child restraint is properly secured prior to each use. If the child restraint is loose, repeat steps 3 through 6.

CHILD RESTRAINT INSTALLATION USING THREE-POINT TYPE SEAT BELT

Installation on rear outboard seats

Front-facing:

Be sure to follow the manufacturer's instructions for the proper use of your child restraint. Follow these steps to install a front-facing child restraint on the rear seats using three-point type seat belt:

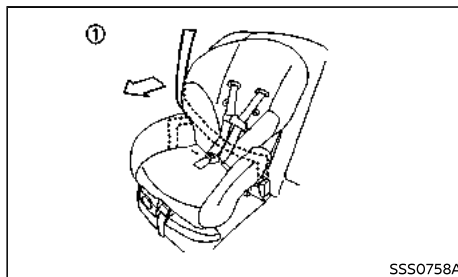

SSS0758A

Front-facing: Step 1

- Position the child restraint on the seat ①.

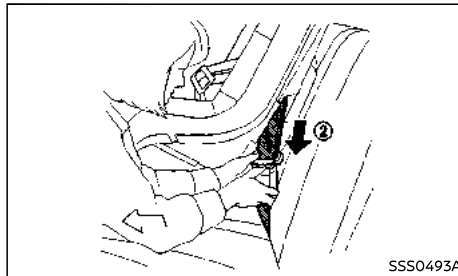

SSS0493A

Front-facing: Step 2

- Route the seat belt tongue through the child restraint and insert it into the buckle ② until you hear and feel the latch engage.
- To prevent slack in the seat belt webbing, it is necessary to secure the seat belt in place with locking devices attached to the child restraint.

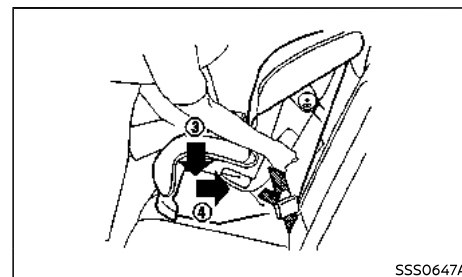

SSS0647A

Front-facing: Step 4

- Remove any additional slack from the seat belt; press downward ③ and rearward ④ firmly in the center of the child restraint with your knee to compress the vehicle seat cushion and seatback while pulling up on the seat belt.

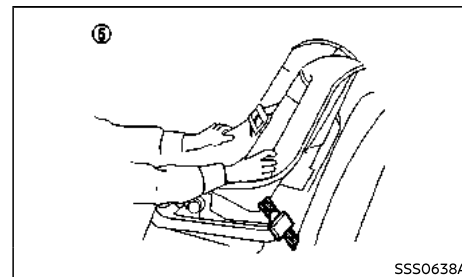

SSS0638A

Front-facing: Step 5

5. Test the child restraint before you place the child in it ⑤. Push the child restraint from side to side and tug it forward to make sure that it is held securely in place.
6. Check to make sure that the child restraint is properly secured prior to each use. If the child restraint is loose, repeat steps 3 through 5.

Rear-facing:

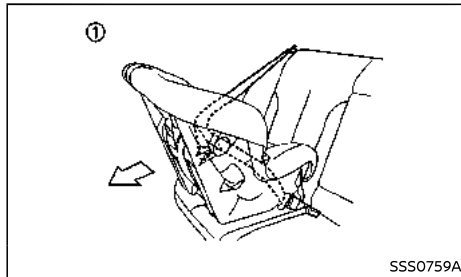

Rear-facing: Step 1

Be sure to follow the manufacturer's instructions for the proper use of your child restraint. Follow these steps to install a rear-facing child restraint on the rear seats using three-point type seat belt:

1. Position the child restraint on the seat ①.

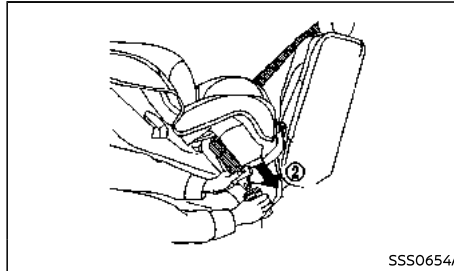

Rear-facing: Step 2

2. Route the seat belt tongue through the child restraint and insert it into the buckle ② until you hear and feel the latch engage.
3. To prevent slack in the seat belt webbing, it is necessary to secure the seat belt in place with locking devices attached to the child restraint.

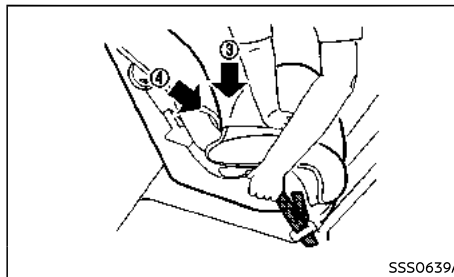

Rear-facing: Step 4

4. Remove any additional slack from the seat belt; press downward ③ and rearward ④ firmly in the center of the child restraint with your hand to compress the vehicle seat cushion and seatback while pulling up on the seat belt.

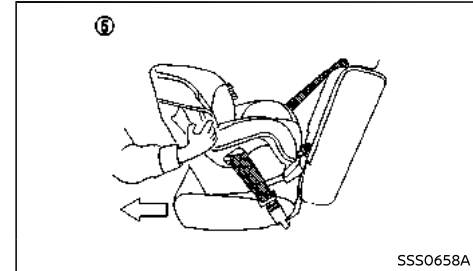

Rear-facing: Step 5

5. Test the child restraint before you place the child in it ⑤. Push the child restraint from side to side and tug it forward to make sure that it is held securely in place.
6. Check to make sure that the child restraint is properly secured prior to each use. If the child restraint is loose, repeat steps 3 through 5.

SUPPLEMENTAL RESTRAINT SYSTEM (SRS)

PRECAUTIONS ON SUPPLEMENTAL RESTRAINT SYSTEM (SRS)

This Supplemental Restraint System (SRS) section contains important information concerning the driver's and passenger's supplemental front-impact air bags and pre-tensioner seat belts.

Supplemental front-impact air bag system

This system can help cushion the impact force to the head and chest area of the driver and/or front passenger in certain frontal collisions. The supplemental front-impact air bag is designed to inflate on the front where the vehicle is impacted.

The SRS is designed to **supplement** the accident protection provided by the driver's and/or front passenger's seat belts and **is not** designed to **substitute** for them. The SRS can help save lives and reduce serious injuries. However, inflating air bags may cause abrasions or other injuries. Air bags do not provide protection to the lower body. Seat belts should always be correctly worn and occupants should always be seated a suitable distance away from the steering wheel and the instrument panel. (See "Seat belts" (P.1-6).) The air bags inflate quickly in order to help protect the occupants. The force of the air bags inflating can increase the risk of injury if the occupants are too close to, or are against, the air bag modules during inflation.

The air bags will deflate quickly after deployment.

The SRS operates only when the ignition switch is in the "ON" position.

When the ignition switch is in the "ON" position, the SRS air bag warning light illuminates for about 7 seconds and then

turns off. This indicates that the SRS is operational. (See "SRS air bag warning light" (P.1-21).)

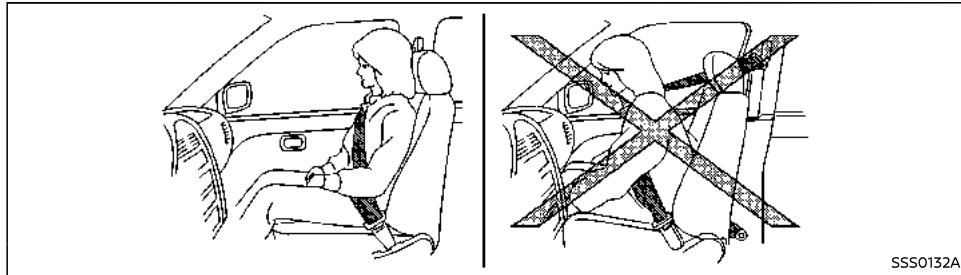
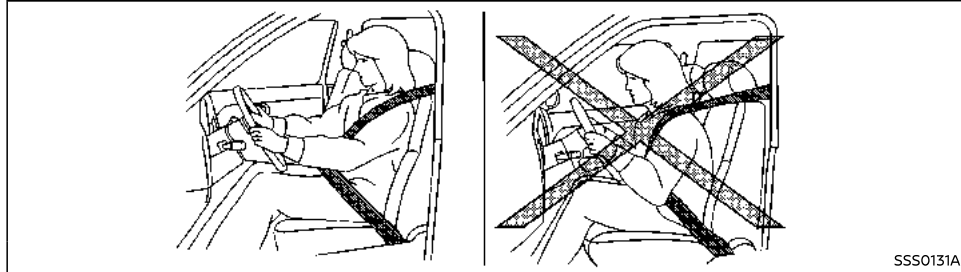

WARNING:

- **The supplemental front-impact air bags ordinarily will not inflate in the event of a side impact, rear impact, rollover, or lower severity frontal collision. Always wear the seat belts to help reduce the risk or severity of injury in accidents.**
- **The seat belts and the supplemental front-impact air bags are most effective when you are sitting well back and up-**

right in the seat. The front-impact air bags inflate with great force. If you are unrestrained, leaning forward, sitting sideways, or out of position in any way, you and your passengers are at greater risk of injury or death in an accident. You and your passengers may also receive serious or fatal injuries from the supplemental front-impact air bag if you are up against it when it inflates. Always sit back against the seatback and as far away as practical from the steering wheel or

instrument panel. Always use the seat belts.

- Keep hands on the outside of the steering wheel. Placing them inside the steering wheel rim could increase the risk of injury if the supplemental front air bag inflates.

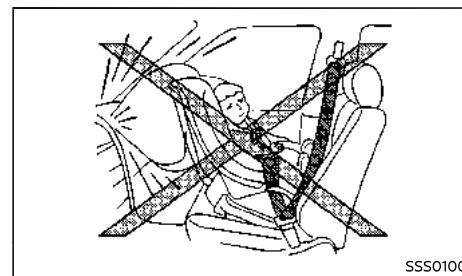
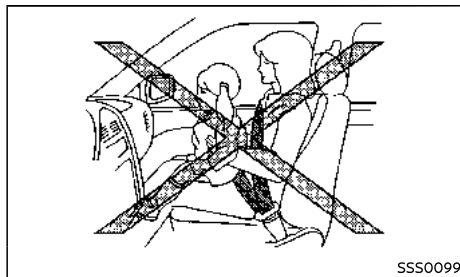
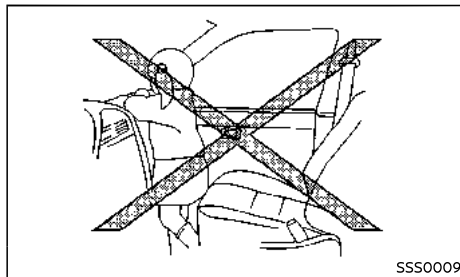
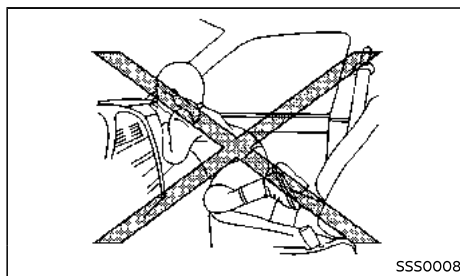
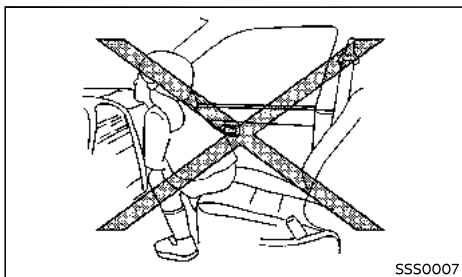
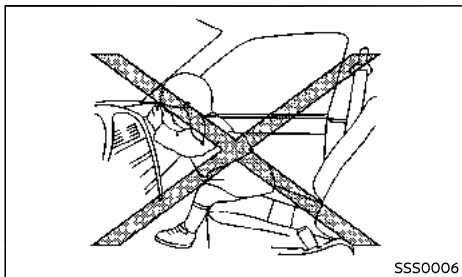

WARNING:

- Never let children ride unrestrained or extend their hands or face out of the window. Do not attempt to hold them in your lap or arms. Some examples of dangerous riding positions are shown in the illustrations.
- Children may be severely injured or killed when the air bags inflate if they are not properly restrained.
- Never install a rear-facing child restraint system in the front seat. An inflating supplemental front-impact air bag could seriously injure or kill your child. (See "Child restraints" (P.1-10).)

Pre-tensioner seat belt system

The pre-tensioner system may activate with the supplemental air bag system in certain types of collisions. Working with the seat belt retractors, it helps tighten the seat belt when the vehicle becomes involved in certain types of collisions, helping to restrain front seat occupants. (See "Pre-tensioner seat belt system" (P.1-24).)

Air bag warning label

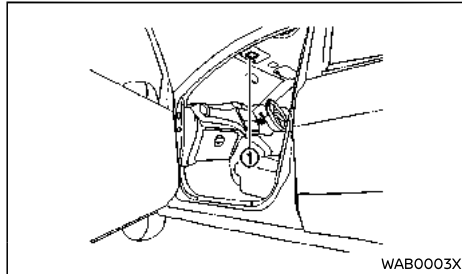

Warning labels about the supplemental air bag system are placed in the vehicle as shown in the illustration.

SRS air bag:

The warning label ① is located on both sides/surfaces of the passenger's sun visor.



The label warns:

"NEVER use a rearward facing child restraint on a seat protected by an ACTIVE AIRBAG in front of it, DEATH or SERIOUS INJURY to the CHILD can occur."

In vehicles equipped with a front-impact pas-

senger air bag system, use a rear-facing child restraint system only on the rear seats.

When installing a child restraint system in your vehicle, always follow the child restraint system manufacturer's instructions for installation. For additional information, see "Child restraints" (P.1-10).

SRS air bag warning light



The supplemental air bag warning light, displaying  in the instrument panel, monitors the circuits for the air bag systems, pre-tensioners and all related wiring.

When the ignition switch is in the "ON", the SRS air bag warning light illuminates for about 3 seconds and then turns off. This indicates that the SRS air bag systems are operational.

If any of the following conditions occur, the air bag and/or pre-tensioner seat belt systems need servicing:

- The SRS air bag warning light remains on after approximately 3 seconds.
- The SRS air bag warning light does not illuminate at all.

Under these conditions, the air bag and/or pre-tensioner seat belt systems may not operate

properly. They must be checked and repaired. Contact a NISSAN dealer immediately.

SUPPLEMENTAL AIR BAG SYSTEMS

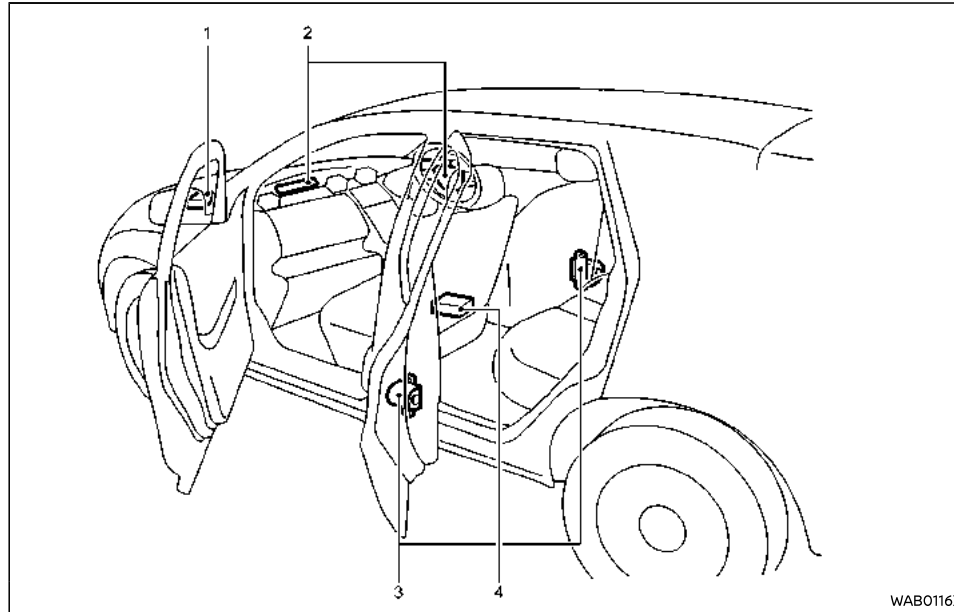

1. Front sensor
2. Supplemental front-impact air bag modules
3. Pre-tensioner seat belt retractors
4. Air bag Control Unit (ACU)



WARNING:

- Do not place any objects on the steering wheel pad and on the instrument panel. Do not place any objects between any occupants and the steering wheel pad and on the instrument panel. Such objects may become dangerous projectiles and cause injury if a supplemental air bag inflates.

- Immediately after inflation, several supplemental air bag system components will be hot. Do not touch them: you may severely burn yourself.
- No unauthorized changes should be made to any components or wiring of the supplemental air bag systems. This is to prevent accidental inflation of the supplemental air bags or damage to the supplemental air bag systems.
- Do not make unauthorized changes to your vehicle's electrical system, suspension system, front end structure, and side panels. This could affect proper operation of the supplemental air bag systems.
- Tampering with the supplemental air bag systems may result in serious personal injury. Tampering includes changes to the steering wheel and the instrument panel by placing materials over the steering wheel pad and above, around or on the instrument panel or by installing additional trim materials around the supplemental air bag systems.
- Work around and on the supplemental air bag systems should be done by a NISSAN dealer. The SRS wiring should not be modified or disconnected. Unauthorized electrical test equipment and probing devices should not be used on the supplemental air bag systems.
- The SRS wiring harness connectors are yellow and/or orange for easy identification.

When the air bags inflate, a fairly loud noise may be heard, followed by the release of smoke. This smoke is not harmful and does not indicate a fire. Care should be taken not to inhale it, as it may cause irritation and choking.

Those with a history of a breathing condition should get fresh air promptly.

Supplemental front-impact air bag system

The driver's supplemental front-impact air bag is located at the center of the steering wheel. The passenger's supplemental front-impact air bag is located at the instrument panel above the glove box.

The supplemental front-impact air bag system is designed to inflate in higher severity frontal collisions, although it may inflate if the forces in another type of collision are similar to those of a higher severity frontal impact. It may not inflate in certain frontal collisions. Vehicle damage (or lack of it) is not always an indication of proper supplemental front-impact air bag system operation.

SRS AIR BAG DEPLOYMENT CONDITIONS

The SRS air bags activate in the event of a front or side impact in which the vehicle occupants may be severely injured even if they are wearing the seat belts properly.

They may not activate when the crash energy is absorbed and/or distributed by the vehicle body. Vehicle damage (or lack of it) is not always an indication of proper SRS air bag system operation.

When the SRS air bag will deploy

Supplemental front-impact air bags:

The supplemental front-impact air bag system is designed to inflate in higher severity frontal collisions. Some examples are shown in the following illustrations.

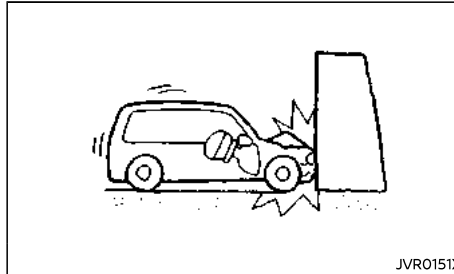

The supplemental front-impact air bag system will deploy in the event of an impact which exceeds a 25 km/h (16 MPH) frontal collision with a solid wall that does not move or deform.

The supplemental front-impact air bag system may also deploy when the vehicle receives severe damage to the undercarriage.

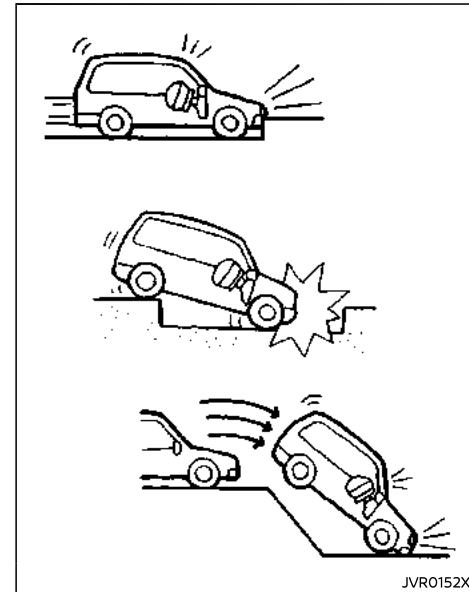

- Hitting a curb, pavement edge or hard surface at high speed
- Falling into a deep hole or ditch
- Landing hard on the ground after jumping

When the SRS air bag is unlikely to deploy
The SRS air bags may not deploy in cases where the impact is not forceful enough to inflate the SRS air bags.

For example, if the vehicle strikes an object, such as a parked vehicle or sign pole, which can move or deform on impact, the SRS air bags are unlikely to deploy.

Supplemental front-impact air bags:

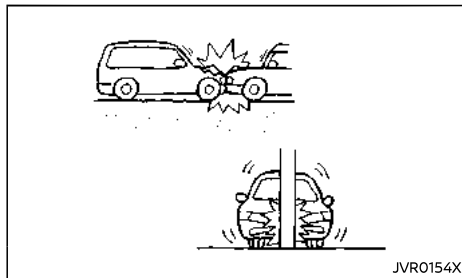

- Striking a vehicle of the same class that is parked
- Crashing into a solid utility pole

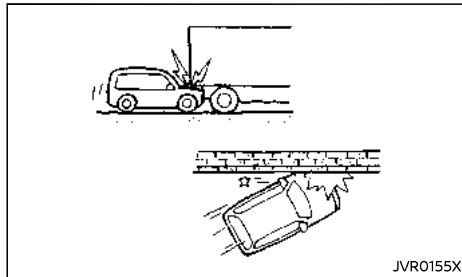

- Running under the tail gate of a truck
- A frontal offset impact to the guard rails

When the SRS air bag will not deploy

Once the SRS air bag has inflated, the air bag module will not function again if your vehicle collides with another vehicle or an object.

Other examples where the SRS air bag will not deploy are shown in the following illustrations.

Supplemental front-impact air bags:

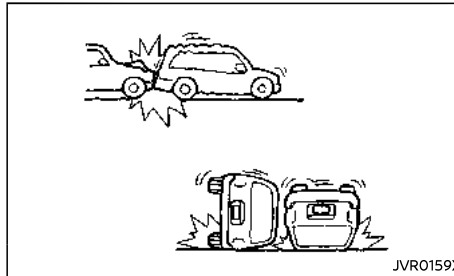

- A collision from the side or rear
- Vehicle rollover

PRE-TENSIONER SEAT BELT SYSTEM

⚠ WARNING:

- **The pre-tensioner seat belt cannot be reused after activation. It must be replaced together with the retractor and buckle as a unit.**
- **If the vehicle becomes involved in a collision but the pre-tensioner is not activated, be sure to have the pre-tensioner system checked and, if necessary, replaced by a NISSAN dealer.**

- **No unauthorized changes should be made to any components or wiring of the pre-tensioner seat belt system. This is to prevent accidental activation of the pre-tensioner seat belt or damage to the pre-tensioner seat belt system.**
- **Work around or on the pre-tensioner seat belt system should be done by a NISSAN dealer. The SRS wiring should not be modified or disconnected. Unauthorized electrical test equipment and probing devices should not be used on the pre-tensioner seat belt system.**
- **If you need to dispose of the pre-tensioner seat belt system, or scrap the vehicle, contact a NISSAN dealer. Correct pre-tensioner disposal procedures are set forth in the appropriate NISSAN Service Manual. Incorrect disposal procedures could cause personal injury.**

The pre-tensioner system may activate with the supplemental air bag system in certain types of collisions. Working with the seat belt retractor, it helps tighten the seat belt when the vehicle becomes involved in certain types of collisions, helping to restrain front seat occupants.

The pre-tensioner is encased with the front seat belt's retractor. These seat belts are used the same as conventional seat belts.

When the pre-tensioner seat belt activates, a fairly loud noise may be heard, followed by the release of smoke. This smoke is not harmful and does not indicate a fire. Care should be taken not to inhale it, as it may cause irritation and choking. Those with a history of a breathing condition should get fresh air promptly.

REPAIR AND REPLACEMENT PROCEDURE



WARNING:

- Once the air bags have been inflated, the air bag modules will not function and must be replaced. The air bag modules must be replaced by a NISSAN dealer. The inflated air bag modules cannot be repaired.
- The air bag systems should be inspected by a NISSAN dealer if there is any damage to the front end portion of the vehicle.
- If you need to dispose of the SRS or scrap the vehicle, contact a NISSAN dealer. Correct disposal procedures are set forth in the appropriate NISSAN Service Manual. Incorrect disposal procedures could cause personal injury.

The air bags and pre-tensioner seat belts are designed to activate on a one-time-only basis. As a reminder, unless the SRS air bag warning light is damaged, the SRS air bag warning light remains illuminated after inflation has occurred. The repair and replacement of the SRS should be done only by a NISSAN dealer.

When maintenance work is required on the vehicle, information about the air bags, pre-tensioner seat belts and related parts should be pointed out to the person performing the maintenance. The ignition switch should always be in the "LOCK" position when working under the hood or inside the vehicle.

AUTOMATIC COLLISION NOTIFICATION (ACN) (if equipped)



WARNING:

- Radio waves could adversely affect electric medical equipment. Individuals who use a pacemaker should contact the device manufacturer regarding any possible effects before using the system.
- Please note that the Automatic Collision Notification (ACN) service cannot be used in the following conditions:
 - The vehicle moves outside the service coverage area and connection with the TCU (Telematics Control Unit) is affected.
 - The vehicle is in a location with poor signal reception such as a tunnel, underground parking, behind a building or in a mountainous area.
- Emergency functions and services will not be available without a subscription. For details, consult a NISSAN dealer.
- The Automatic Collision Notification (ACN) service may not function properly depending on the severity of a collision and/or emergency.

The TCU (Telematics Control Unit) equipped on this vehicle sends a notification automatically to the registered contact number and the emergency contact number (configured in Nissan Connect App) with location of incident in the case an accident severe enough to trigger one of the vehicle's air bags occurs.

NOTE:

If emergency contact number is not configured, notification will be sent, only to the registered contact number.

We recommend you to configure the emer-

gency contact number in the Nissan Connect App immediately after activating the Nissan-Connect.

MEMO

2 Instruments and controls

Cockpit	2-2	Headlight aiming control	2-21
Instrument panel	2-3	Turn signal switch	2-21
Meters and gauges	2-4	Fog light switch (if equipped)	2-22
Speedometer	2-5	Front fog lights	2-22
Tachometer	2-6	Wiper and washer switch	2-22
Odometer/trip odometer/distance to empty	2-6	Windshield wiper and washer switch	2-22
Engine coolant temperature gauge	2-7	Rear window wiper and washer switch	2-23
Fuel gauge	2-7	Defogger switch	2-23
Gear shift indicator (if equipped)	2-8	Horn	2-23
Instrument brightness control (if equipped)	2-8	Windows	2-24
Continuously Variable Transmission (CVT) position indicator (if equipped)	2-8	Power windows	2-24
Warning lights, indicator lights and audible reminders	2-9	Power outlet	2-25
Checking lights	2-10	Storage	2-26
Warning lights	2-10	Glove box	2-26
Indicator lights	2-13	Card holder	2-26
Audible reminders	2-14	Cup holders	2-26
Vehicle information display (type A)	2-15	Cargo cover (if equipped)	2-27
Pop up warnings	2-16	Luggage hooks	2-28
Trip computer	2-16	Coat hook	2-28
Clock and outside air temperature	2-18	Roof rack	2-29
Vehicle information display (type B)	2-18	Sun visors	2-29
Trip computer	2-19	Interior lights	2-30
Headlight and turn signal switch	2-20	Front and rear room light	2-30
Headlight switch	2-20	Front map lights	2-30
		Cargo room light (if equipped)	2-30



COCKPIT

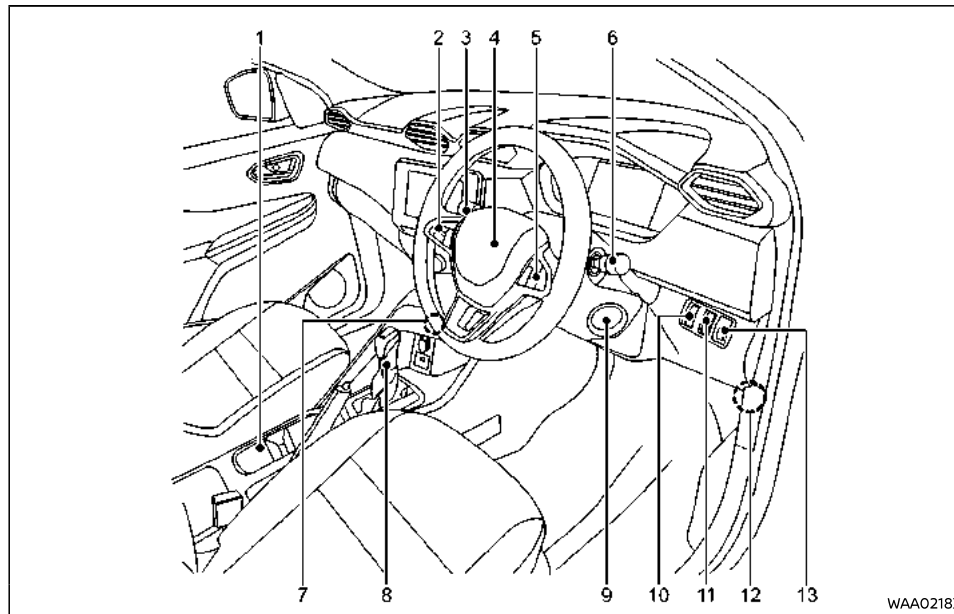

1. Cup holders
2. Steering-wheel mounted controls (left-side)*
 - Audio system* or Multimedia system*
3. Wiper and washer switch
4. Steering wheel
 - Power steering
 - Horn
 - Driver's supplemental front-impact air bag
5. Steering-wheel mounted controls (right-side)*
 - Audio system*
 - Cruise control switches*
 - Trip computer switch (for vehicle information display (type A))*
6. Headlight and turn signal switch/Fog light switch*
7. Push-button ignition switch (models with Intelligent Key system)

8. Shift lever
 - Continuously Variable Transmission (CVT)
 - Manual Transmission (MT)
 9. Ignition switch (models without Intelligent Key system)
 10. Vehicle Dynamic Control (VDC) OFF switch*
 11. Cruise control MAIN switch*
 12. Hood lock release handle
 13. Headlight aiming control switch
- *: if equipped

2-2 Instruments and controls

INSTRUMENT PANEL

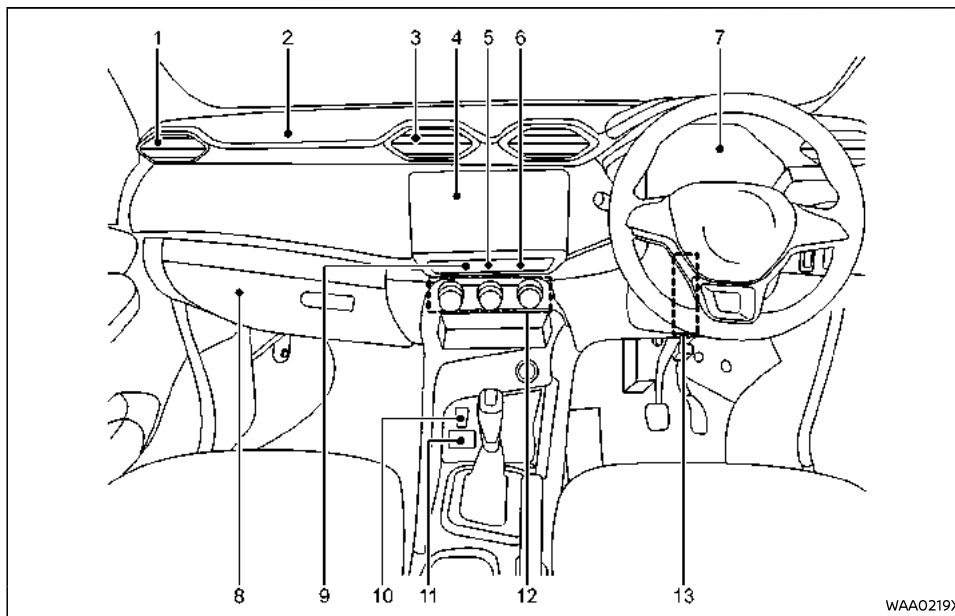

- | | |
|--|---|
| 1. Side ventilator | 7. Meters and gauges |
| 2. Front passenger's supplemental front-impact air bag | 8. Glove box |
| 3. Center ventilator | 9. Defogger switch |
| 4. Audio system* or Multimedia system*
— Rear view monitor*
— Around View Monitor* | 10. Power outlet |
| 5. Hazard indicator flasher switch | 11. USB (Universal Serial Bus) connection port* |
| 6. Power door lock switch* or inside back door opener switch* | 12. Heater and air conditioner control |
| | 13. Tilting steering wheel lock lever |
| | *: if equipped |

METERS AND GAUGES

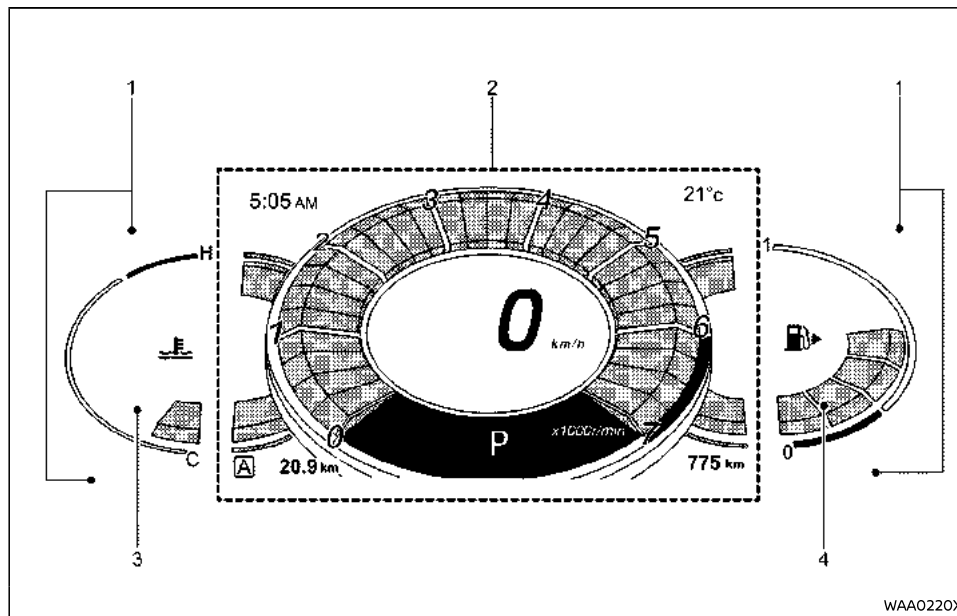

Type A

WAA0220X

- | | |
|---|---|
| <ol style="list-style-type: none"> 1. Warning and indicator lights 2. Vehicle information display <ul style="list-style-type: none"> – Speedometer – Tachometer – Odometer/trip odometer/distance to empty – Trip computer – Clock and outside air temperature – Warning and indicator lights – Gear shift indicator* | <ul style="list-style-type: none"> – Continuously Variable Transmission (CVT) position indicator* – Cruise control* – Pop up warnings <ol style="list-style-type: none"> 3. Engine coolant temperature gauge 4. Fuel gauge <p>*: if equipped</p> |
|---|---|

2-4 Instruments and controls

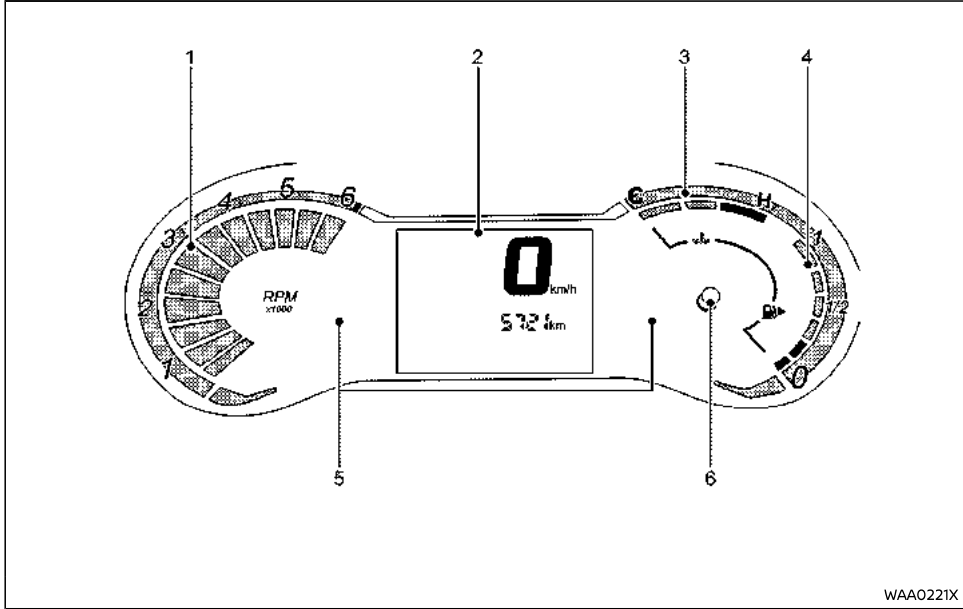

Type B

- | | |
|---|--|
| <ol style="list-style-type: none"> 1. Tachometer 2. Vehicle information display <ul style="list-style-type: none"> – Speedometer – Odometer/trip odometer/distance to empty – Trip computer – Gear shift indicator* – Continuously Variable Transmission (CVT) position indicator* 3. Engine coolant temperature gauge | <ol style="list-style-type: none"> 4. Fuel gauge 5. Warning and indicator lights 6. Trip computer mode switch <p>*: if equipped</p> |
|---|--|

SPEEDOMETER

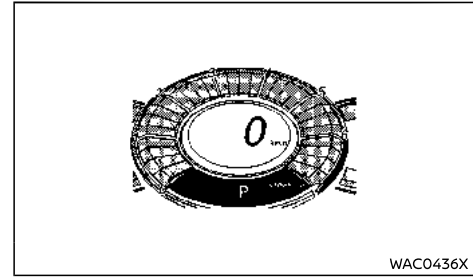

Type A

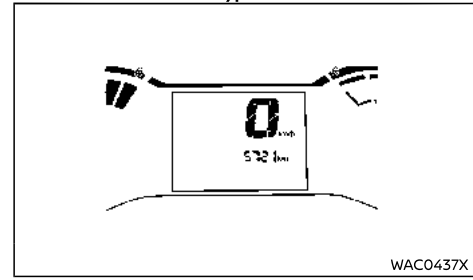

Type B

The speedometer indicates the vehicle speed.

TACHOMETER

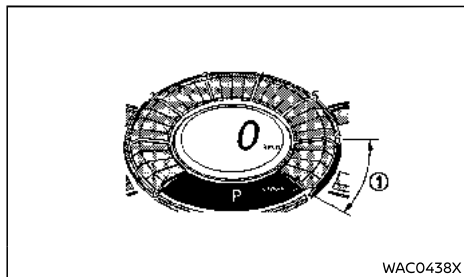

Type A

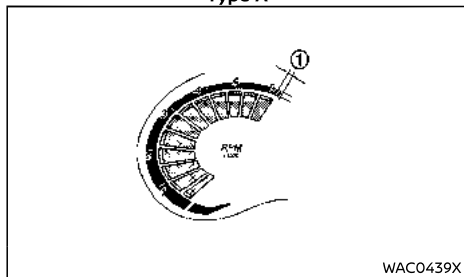

Type B

The tachometer indicates the engine speed in revolutions per minute (rpm). **Do not increase the engine speed into the red zone ①.**

The red zone varies with models.

ODOMETER/TRIP ODOMETER/DISTANCE TO EMPTY

Type A

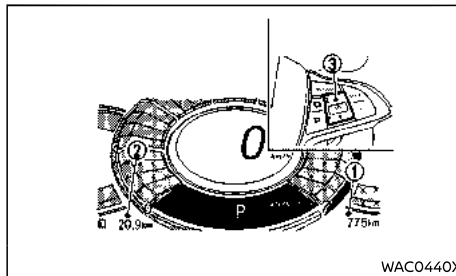

WAC0440X

The odometer ①, twin trip odometer and distance to empty ② are displayed in the vehicle information display when the ignition switch is in the "ON" position.

The odometer displays the total distance the vehicle has been driven. The twin trip odometer displays the distance of individual trips.

The distance to empty (dte) provides you with an estimation of the distance that can be driven before refueling. The dte is constantly being calculated based on the amount of fuel in the fuel tank and the actual fuel consumption.

Changing twin trip odometer display:

Push the OK switch ③ on the steering wheel to change the display as follows:

TRIP A → Distance to empty (dte) → TRIP B → TRIP A

Resetting twin trip odometer:

To reset the twin trip odometer, push and hold the OK switch ③.

Type B

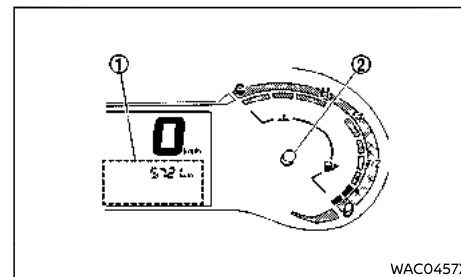

WAC0457X

The odometer, trip odometer and distance to empty ① are displayed in the vehicle information display when the ignition switch is in the "ON" position.

The odometer displays the total distance the vehicle has been driven. The trip odometer (A or B) displays the distance of individual trips.

The distance to empty (dte) provides you with an estimation of the distance that can be driven before refueling. The dte is constantly being calculated based on the amount of fuel in the fuel tank and the actual fuel consumption.

Changing trip odometer display:

To change the display, push the trip computer mode switch ② on the meter panel.

(See "Trip computer" (P.2-19).)

Resetting trip odometer:

To reset the trip odometer, push and hold the trip computer mode switch ②.
(See "Trip computer" (P.2-19).)

ENGINE COOLANT TEMPERATURE GAUGE

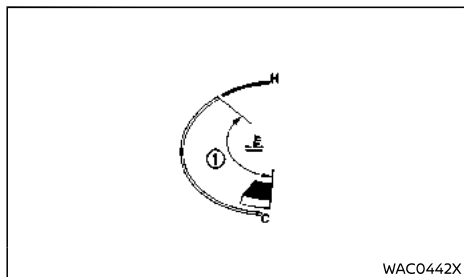

Type A

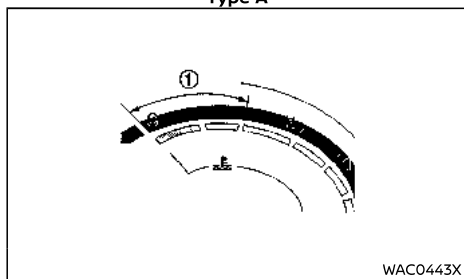

Type B

The engine coolant temperature gauge indicates the engine coolant temperature.

The engine coolant temperature is normal when the gauge points within the zone ① shown in the illustration.

The engine coolant temperature will vary with

the outside air temperature and driving conditions.

For the coolant temperature warning light, see "Coolant temperature warning light" (P.2-10).

CAUTION:

- If the gauge indicates engine coolant temperature near the hot (H) end of the normal range, reduce vehicle speed to decrease temperature.
- If the gauge is over the normal range, stop the vehicle as soon as safely possible.
- If the engine is overheated, continued operation of the vehicle may seriously damage the engine. (See "If your vehicle overheats" (P.6-8).)

FUEL GAUGE

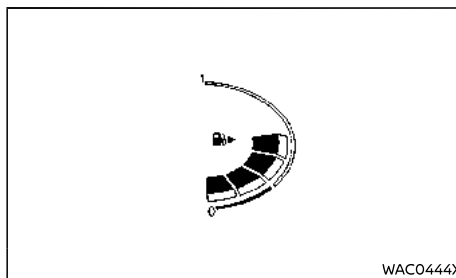

Type A

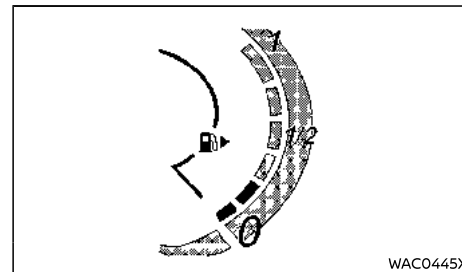

Type B

The fuel gauge indicates the approximate fuel level in the tank when the ignition switch is in the "ON" position.

The gauge may move slightly during braking, turning, accelerating, or going up and down hills due to movement of fuel in the tank.

The warning light ① gets ON when ignition is "ON" and remains lit permanently (or) depending on the variant, the warning light goes off after few seconds. Depending on the variants, if it blinks (or) gets ON when driving and accompanied by a beep, it indicates the fuel level is getting low. Fill up with fuel as soon as possible.

The arrow, ②, indicates that the fuel-filler lid is located on the right side of the vehicle.

NOTE:

For accurate indication, before filling, it is recommended to switch off ignition, wait for at least 15 seconds and fill at least 5 liters of fuel.

CAUTION:

Refuel before the gauge reads 0 (empty).

There is a small reserve of fuel in the tank when the fuel gauge reads 0 (empty).

GEAR SHIFT INDICATOR (if equipped)

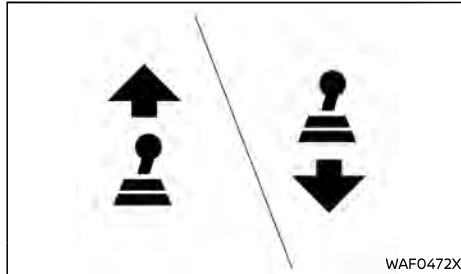

Example

This lights up to advise you to change to a higher gear (up arrows) or lower gear (down arrow).

(See "Gear shift indicator" (P.5-14).)

INSTRUMENT BRIGHTNESS CONTROL (if equipped)

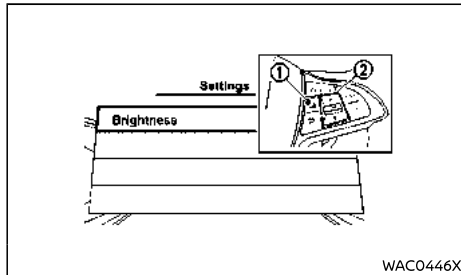

The instrument brightness control can be operated when the ignition switch is in the "ON" position and the headlights are on.

Push switch ① on the right side of the steering wheel until "Settings" menu appears on the

vehicle information display, then select "Brightness" and push the OK switch ②.

























The brightness can be increased or decreased by $\blacktriangle/\blacktriangledown$ switch ②.

CONTINUOUSLY VARIABLE TRANSMISSION (CVT) POSITION INDICATOR (if equipped)





The Continuously Variable Transmission (CVT) position indicator indicates the shift lever position when the ignition switch is in the "ON" position.









See "Driving with Continuously Variable Transmission (CVT)" (P.5-10) for further details.

WARNING LIGHTS, INDICATOR LIGHTS AND AUDIBLE REMINDERS

	Anti-lock Braking System (ABS) warning light		Malfunction warning light*		Malfunction Indicator Light (MIL)
	Brake warning light		Seat belt warning light		Service indicator light*
	Charge warning light		Supplemental Restraint System (SRS) air bag warning light		Small light indicator light
	Coolant temperature warning light		Vehicle Dynamic Control (VDC) warning light*		STOP indicator light*
	Door open warning light*		Brake pedal indicator light*		Turn signals/hazard indicator lights
	Electric power steering warning light		Cruise control indicator*		Vehicle Dynamic Control (VDC) off indicator light*
	Engine oil pressure warning light*		Front fog light indicator light*		
	Low fuel warning light		High beam indicator light		*: if equipped
	Low tire pressure warning light*		Low beam indicator light		

CHECKING LIGHTS

With all doors closed, apply the parking brake, fasten the seat belts and place the ignition switch in the "ON" position without starting the engine. The following lights (if equipped) will come on: , , , .

The following lights (if equipped) will come on briefly and then go off: , , , , , , , , .

If any light does not come on or operates in a way other than described, it may indicate a burned-out bulb and/or a system malfunction. Have the system checked by a NISSAN dealer.

WARNING LIGHTS

Anti-lock Braking System (ABS) warning light

When the ignition switch is in the "ON" position, the Anti-lock Braking System (ABS) warning light illuminates and then turns off. This indicates the ABS is operational.

If the ABS warning light illuminates while the engine is running, or while driving, it may indicate the ABS is not functioning properly. Have the system checked by a NISSAN dealer promptly.

If an ABS malfunction occurs, the anti-lock function is turned off. The brake system then operates normally, but without anti-lock assistance. (See "Brake system" (P.5-24).)

Brake warning light

WARNING:

- **If the brake fluid level is below the minimum mark on the brake fluid reservoir, do not drive the vehicle until the brake system has been checked by a NISSAN dealer.**
- **Even if you judge it to be safe, have your vehicle towed because driving it could be dangerous.**
- **Depressing the brake pedal without the engine running and/or with a low brake fluid level could increase the stopping distance and require greater pedal travel distance and effort.**

The brake warning light indicates the parking brake system operation, a low brake fluid level of the brake system and an Anti-lock Braking System (ABS) malfunction.

Parking brake warning indicator:

When the ignition switch is placed in the "ON" position, the brake warning light illuminates. When the parking brake is released, the brake warning light turns off.

If the parking brake is not fully released, the brake warning light remains on. Be sure that the brake warning light has turned off before driving. (See "Parking brake" (P.3-19).)

Low brake fluid warning indicator:

If the brake warning light illuminates during braking with the STOP indicator light (if equipped) and a beep, it indicates that the fluid level in the brake system is low or that there is a braking system malfunction. Stop the vehicle safely as soon as possible. Do not drive the

vehicle and contact a NISSAN dealer.

Anti-lock Braking System (ABS) warning indicator:

When the parking brake is released and the brake fluid level is sufficient, if both the brake warning light and the Anti-lock Braking System (ABS) warning light illuminate, it may indicate the ABS is not functioning properly. Have the brake system checked, and if necessary repaired, by a NISSAN dealer promptly. (See "Anti-lock Braking System (ABS) warning light" (P.2-10).)

Charge warning light

The charge warning light illuminates and then turns off. This indicates the charging system is operational.

If charge warning light illuminates with the STOP indicator light (if equipped) and a beep, this indicates an overload or discharge in the electrical circuit. Stop the vehicle safely as soon as possible. Do not drive the vehicle and contact a NISSAN dealer.

CAUTION:

Do not continue driving if the alternator belt is loose, broken or missing.

Coolant temperature warning light

This bar display comes ON when the ignition switch is in the "ON" position and remains lit permanently (or) depending on the variant, the warning light goes off after few seconds.

Depending on the variants, if it blinks (or) gets ON when driving, this means the engine is overheating. Stop and allow the engine to run

at idle speed for a minute or two. The temperature should drop. If not, stop the engine. Let it cool down. Contact a NISSAN dealer if necessary.

 Door open warning light (if equipped)

The door open warning light illuminates if any of the doors are open or not closed securely.

 Electric power steering warning light

When the ignition switch is in the "ON" position, the electric power steering warning light illuminates for a few seconds and then turns off. This indicates the electric power steering is operational.

If the electric power steering warning light illuminates continuously, it may indicate the electric power steering is not functioning properly and may need servicing. Have the electric power steering checked by a NISSAN dealer.

When the electric power steering warning light illuminates with the engine running, the power assist to the steering will cease operation but you will still have control of the vehicle. At this time, greater steering efforts are required to operate the steering wheel, especially in sharp turns and at low speeds. (See "Electric power steering" (P.5-23).)

 Engine oil pressure warning light (if equipped)

When the ignition switch is in the "ON" position, the engine oil pressure warning light illuminates and then turns off. This indicates that the oil pressure sensors in the engine are operational.

If the engine oil pressure warning light and STOP indicator light (if equipped) illuminate and a beep sounds while the engine is running, it may indicate that the engine oil pressure is low.

Stop the vehicle safely as soon as possible. Stop the engine immediately and contact a NISSAN dealer.



CAUTION:

- **Running the engine with the engine oil pressure warning light illuminated could cause serious damage to the engine.**
- **The engine oil pressure warning light is not designed to indicate a low oil level. The oil level should be checked using the dipstick. (See "Engine oil" (P.8-8).)**

 Low fuel warning light

The warning light gets ON when ignition is "ON" and remains lit permanently (or) depending on the variant, the warning light goes off after few seconds.

Depending on the variants, if it blinks (or) gets ON when driving and accompanied by a beep, it indicates the fuel level is getting low. Fill up with fuel as soon as possible.

NOTE:

For accurate indication, before filling, it is recommended to switch off ignition, wait at least 15 seconds and fill at least 5 liters of fuel.

 Low tire pressure warning light (if equipped)

When the ignition switch is in the "ON" position, the low tire pressure warning light illuminates and then turns off. This indicates that the low tire pressure warning system is operational.

This light illuminates if there is low tire pressure or a tire pressure warning system malfunction.

The Tire Pressure Monitoring System (TPMS) monitors the tire pressure of all tires except the spare.

Low tire pressure warning:

If the vehicle is being driven with low tire pressure, the warning light will illuminate. A low tire pressure telltale (if equipped) also appears in the vehicle information display.

When the low tire pressure warning light illuminates, you should stop and adjust the tire pressure to the recommended COLD tire pressure shown on the tire placard. The low tire pressure warning light does not automatically turn off when the tire pressure is adjusted. After the tire is inflated to the recommended pressure, the vehicle must be driven at speeds above 25 km/h (16 MPH) to activate the TPMS and turn off the low tire pressure warning light. Use a tire pressure gauge to check the tire pressure. The low tire pressure telltale appears each time the ignition switch is placed in the "ON" position as long as the low tire pressure warning light remains illuminated.

For additional information, see "Tire Pressure

Monitoring System (TPMS)" (P.5-3) and "Tire Pressure Monitoring System (TPMS)" (P.6-2).

TPMS malfunction:

If the TPMS is not functioning properly, the low tire pressure warning light will flash for approximately 1 minute when the ignition switch is placed in the "ON" position. The light will remain on after the 1 minute. Have the system checked by a NISSAN dealer. A low tire pressure telltale does not appear if the low tire pressure warning light illuminates to indicate a TPMS malfunction.

For additional information, see "Tire Pressure Monitoring System (TPMS)" (P.5-3).



WARNING:

- If the light does not illuminate with the ignition switch placed in the "ON" position, have the vehicle checked by a NISSAN dealer as soon as possible.
- If the light illuminates while driving, avoid sudden steering maneuvers or abrupt braking, reduce vehicle speed, pull off the road to a safe location and stop the vehicle as soon as possible. Driving with under-inflated tires may permanently damage the tires and increase the likelihood of tire failure. Serious vehicle damage could occur and may lead to an accident and could result in serious personal injury. Check the tire pressure for all four tires. Adjust the tire pressure to the recommended COLD tire pressure shown on the tire placard to turn the low tire pressure warning light OFF. If the light still illuminates while driving after adjusting the tire pressure, a tire may be flat or the TPMS may be malfunctioning. If you have a flat tire, replace it with a

spare tire as soon as possible. If no tire is flat and all tires are properly inflated, have the vehicle checked by a NISSAN dealer.

- Since the spare tire is not equipped with the TPMS, when a spare tire is mounted or a wheel is replaced, the TPMS will not function and the low tire pressure warning light will flash for approximately 1 minute. The light will remain on after 1 minute. Contact your NISSAN dealer as soon as possible for tire replacement.
- Replacing tires with those not originally specified by NISSAN could affect the proper operation of the TPMS.



CAUTION:

- The TPMS is not a substitute for the regular tire pressure check. Be sure to check the tire pressure regularly.
- If the vehicle is being driven at speeds of less than 25 km/h (16 MPH), the TPMS may not operate correctly.
- Be sure to correctly install the specified size of tires to all four wheels.



Malfunction warning light (if equipped)

Warning light (orange):

This lights up when the ignition is switched on and goes out after few seconds. It may come on in conjunction with other warning lights on the instrument panel. It means you should drive very carefully to a NISSAN dealer as soon as possible. If you fail to follow this recommendation, you risk damaging your vehicle.

Urgent stop warning light (red):

This lights up when the ignition is switched on and goes out after few seconds. It may come on in conjunction with other warning lights on the instrument panel and is accompanied by a beep. It requires you to stop immediately, for your own safety, as soon as traffic conditions allow. Switch off the engine and do not restart it. Contact a NISSAN dealer as soon as possible.



Seat belt warning light

Depending on the vehicle, it comes on in the cluster when the ignition is "ON" and goes off after few seconds. The light will remain ON if the driver's or front passenger's (if seated) seat belt is not fastened. When the vehicle is being driven, the light flashes and a beep sounds for about 2 minutes when the vehicle reaches a speed of approximately 20 Km/h and above until the driver's or passenger's (if seated) seat belt is fastened.



Supplemental Restraint System (SRS) air bag warning light

When the ignition switch is in the "ON" position, the Supplemental Restraint System (SRS) air bag warning light illuminates for about 3 seconds and then turns off. This indicates the SRS air bag system is operational.

If any of the following conditions occur, the SRS air bag system and pre-tensioner seat belt need servicing. Have the system checked, and if necessary repaired, by a NISSAN dealer promptly.

- The SRS air bag warning light remains illuminated after about 3 seconds.

- The SRS air bag warning light does not come on at all.

Unless checked and repaired, the SRS air bag system and/or pre-tensioner seat belt may not function properly. (See “Supplemental Restraint System (SRS)” (P.1-19).)

Vehicle Dynamic Control (VDC) warning light (if equipped)

When the ignition switch is in the “ON” position, the Vehicle Dynamic Control (VDC) warning light illuminates and then turns off. This indicates the VDC system is operational.

The warning light blinks when the VDC system is operating.

When the warning light blinks while driving, the driving condition is slippery and the vehicle's traction limit is about to be exceeded.

If the warning light illuminates when the ignition switch is placed in the “ON” position, it may indicate that the VDC system is not functioning properly and may need servicing. Have the system checked, and if necessary repaired, by a NISSAN dealer promptly.

If a malfunction occurs in the system, the VDC system function will be cancelled but the vehicle is still driveable. (See “Vehicle Dynamic Control (VDC) system” (P.5-15).)

INDICATOR LIGHTS

Brake pedal indicator light (if equipped)

The brake pedal indicator light illuminates when it is necessary to depress the brake pedal.

Cruise control indicator (if equipped)

The cruise control indicator indicates the activation of the cruise control system. (See “Cruise control” (P.5-17).)

Front fog light indicator light (if equipped)

The front fog light indicator light illuminates when the front fog lights are on. (See “Fog light switch” (P.2-22).)

High beam indicator light

The high beam indicator light illuminates when the headlight high beam is on. The indicator light turns off when the low beam is selected. (See “Headlight and turn signal switch” (P.2-20).)

Low beam indicator light

The low beam indicator light illuminates when the headlight low beam is on. The indicator light turns off when either the  position or the high beam is selected. (See “Headlight and turn signal switch” (P.2-20).)

Malfunction Indicator Light (MIL)



CAUTION:

- **Continuing vehicle operation without proper servicing of the emission control system could lead to poor driveability, reduced fuel economy, and damage to the emission control system, which may affect the vehicle's warranty coverage.**
- **Incorrect setting of the emission control system may lead to non-compliance of local and national emission laws and regulations.**

When the ignition switch is in the “ON” position, the Malfunction Indicator Light (MIL) illuminates. After starting the engine, the MIL turns off. This indicates that the emission control system is operational.

If the MIL illuminates or blinks while the engine is running, it may indicate a potential emission control system malfunction. In this case, the emission control system may not function properly and may need servicing. Have the system checked, and if necessary repaired, by a NISSAN dealer promptly.

To reduce or avoid possible damage to the engine control system when the MIL illuminates or blinks:

- Avoid driving at speeds above 70 km/h (43 MPH).
- Avoid sudden acceleration or deceleration.
- Avoid going up steep uphill grades.
- Avoid carrying or towing unnecessary loads.



Service indicator light (if equipped)

The service indicator light illuminates when the ignition is switched "ON" and turns off after few seconds. It can illuminate in conjunction with other indicator lights and/or messages on the instrument panel. It means you should drive very carefully to a NISSAN dealer as soon as possible. If you fail to follow this recommendation, you risk damaging your vehicle.



Small light indicator light

The small light indicator light illuminates when the front clearance lights, instrument panel lights, rear combination lights and license plate lights are on. The indicator light turns off when these lights are turned off.



STOP indicator light (if equipped)

The STOP indicator light illuminates when the ignition is switched "ON" and turns off after few seconds. It comes on with other warning lights and/or messages, and is accompanied by a beep. It requires you to stop the vehicle immediately, for your own safety, as soon as traffic conditions allow. Turn off the engine and do not restart. Contact a NISSAN dealer.



Turn signals/hazard indicator lights

The turn signals/hazard indicator lights blink when the turn signal switch or hazard indicator flasher switch is turned on. (See "Headlight and turn signal switch" (P.2-20) or "Hazard indicator flasher switch" (P.6-2).)



Vehicle Dynamic Control (VDC) off indicator light (if equipped)

When the ignition switch is in the "ON" position, the Vehicle Dynamic Control (VDC) off indicator light illuminates and then turns off.

The VDC off indicator light illuminates when the VDC OFF switch is pushed to the "OFF" position.

When the VDC OFF switch is pushed to the "OFF" position, the VDC system is turned off. (See "Vehicle Dynamic Control (VDC) system" (P.5-15).)

AUDIBLE REMINDERS

Door open reminder chime

When vehicle speed exceeds 20 km/h (12 MPH), the door open reminder chime will sound intermittently until the vehicle is stopped and the door is closed properly.

Light reminder chime

The light reminder chime will sound if the driver's side door is opened and the headlight switch is in either the or position, and the ignition switch is in the "OFF" or "LOCK" position.

Be sure to turn the headlight switch to the "OFF" position when you leave the vehicle.

Parking brake reminder chime

The parking brake reminder chime will sound if the vehicle is driven at speeds more than 7 km/h (4 MPH) with the parking brake applied. Stop the vehicle and release the parking brake.

Speed warning chime (if equipped)

Primary warning:

When vehicle speed exceeds 80 km/h (50 MPH), a chime will sound once per 2 minutes as a primary warning until the driver reduces the speed to less than 80 km/h (50 MPH).

Secondary warning:

When vehicle speed exceeds 120 km/h (75 MPH), a chime will sound continuously for once per 2 seconds as a secondary warning until the driver reduces the speed to less than 120 km/h (75 MPH) after which it will switch to the primary warning.

VEHICLE INFORMATION DISPLAY (type A)

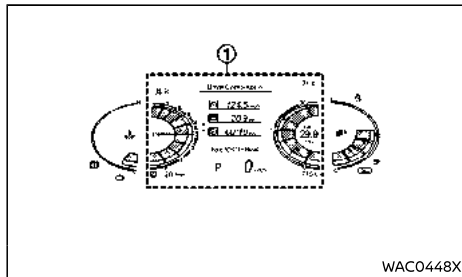

Example

The vehicle information display ① is located on the center of the meter panel. The following items are displayed if the vehicle is equipped with them.

- Speedometer
 - “Speedometer” (P.2-5)
- Tachometer
 - “Tachometer” (P.2-6)
- Odometer/twin trip odometer/distance to empty
 - “Odometer/trip odometer/distance to empty” (P.2-6)
- Trip computer
 - “Trip computer” (P.2-16)
- Clock and outside air temperature
 - “Clock and outside air temperature” (P.2-18)
- Warning and indicator lights
 - “Warning lights, indicator lights and audible reminders” (P.2-9)
- Gear shift indicator
 - “Gear shift indicator” (P.5-14)
- Continuously Variable Transmission (CVT) position indicator

- “Continuously Variable Transmission (CVT) position indicator” (P.2-8)
- Cruise control
 - “Cruise control” (P.5-17)
- Intelligent Key system information
- Display messages
 - Information messages
 - Operating fault messages
 - “Pop up warnings” (P.2-16)

POP UP WARNINGS

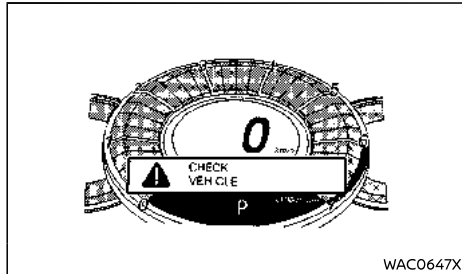

Example

Depending on the situation, some pop up warnings are displayed on the vehicle information display.

The critical warnings cannot be removed by the driver, unless necessary actions are taken.

Other warnings can be removed by pressing the OK switch on the right side of the steering wheel, and only the necessary warnings are memorized in the Warnings page. (See "Warnings" (P.2-17).)

If multiple pop up warnings are triggered by the vehicle, the pop up warnings will be displayed one after another based on their priority.

TRIP COMPUTER

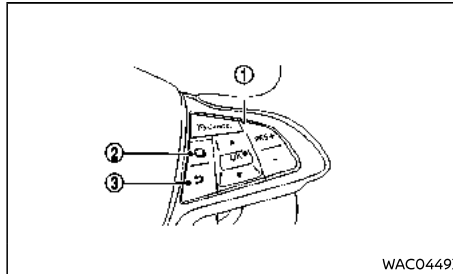

Switches for the trip computer are located on the right side of the steering wheel. To operate the trip computer, push the switches.

① and OK switch - change or select an item

② switch - change displays

③ switch - go back to the previous menu

When the ignition switch is placed in the "ON" position, modes of the trip computer can be selected by pushing the switch ②.

Each time the switch ② is pushed, the display will change as follows:

(Available displays vary depending on the vehicle's equipment.)

Home (Speedometer and tachometer) → Fuel Economy and Fuel History → Drive Computer (A/B) → Tire Pressure screen → Warnings → Settings

When the OK switch ① is pushed and held for more than 3 seconds, the average speed, elapsed time, the trip odometer, the current and average fuel consumption will be reset.

When the switch ③ is pushed and held for

more than 3 seconds, the current display page directly returns to the home page. The switch ① will navigate in the menu page.

Home (speedometer and tachometer)

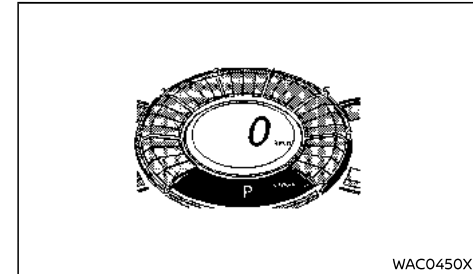

The home display shows speedometer (see "Speedometer" (P.2-5)) and tachometer (see "Tachometer" (P.2-6)).

Fuel Economy and Fuel History

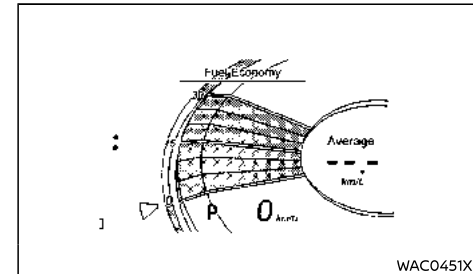

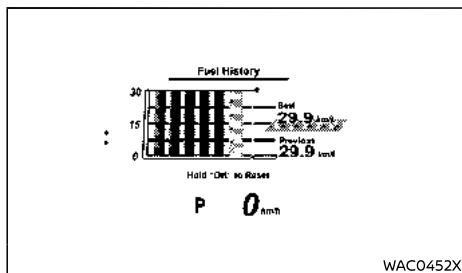

The Fuel Economy display shows current and average fuel consumption. The average fuel economy in the fuel economy page will be reset every time when the ignition switch is placed in the "OFF" position to "ON" position.

Push down the \blacktriangle switch ① to show the Fuel History display. The Fuel History shows the best and the previous fuel consumption. Push and hold the OK switch ① to reset the Fuel History.

Drive Computer (A/B)

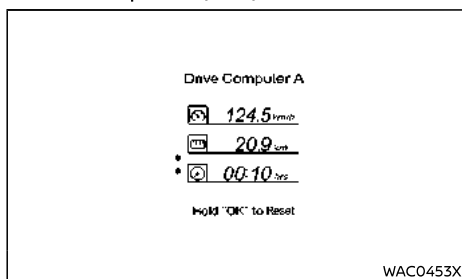

Drive Computer A/B shows the average speed, trip odometer and the elapsed time. Push down the \blacktriangle switch ① to switch the Drive Computer A to Drive Computer B. Push and hold the OK

switch ① to reset the average speed, trip odometer and the elapsed time.

Tyre Pressure screen (if equipped)

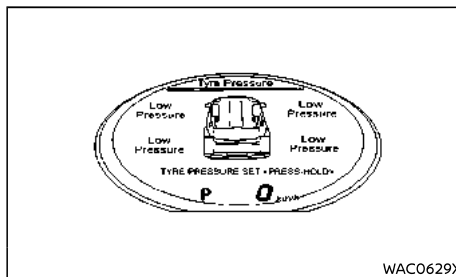

Example

Tyre Pressure screen shows the tire pressure or related warning informations.

The Tire Pressure screen is also displayed if a low tire pressure or a malfunction is detected.

- Tires in yellow: Sensor failure is detected
- Tires in amber: Low tire pressure is detected
- Tires in red: Tire puncture is detected

When the tire pressures are correct and no malfunction is detected, all four tires are displayed in white.

Tire pressure reset function:

When the OK switch ① is pushed and held for more than 3 seconds, the TPMS reset request message will appear. You can reset the tire pressure to the new pressure value as per tire placard on your vehicle. (See "Tire placard" (P.9-8).)

Warnings

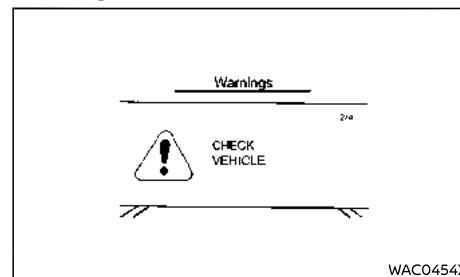

Example

Warnings will only be displayed if there are any present.

Settings

The \blacktriangle and OK switch ① is used in the setting mode.

Use the \blacktriangle switch to select a menu.

Push OK switch to decide a menu.

Service reminder

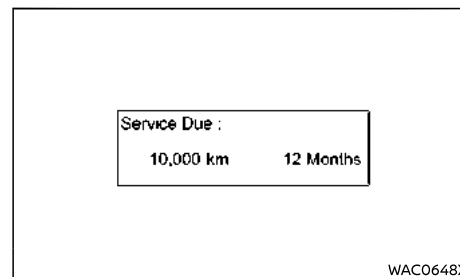

Example

Mileage before service:

With the ignition switch in the "ON" position, the engine not running and the display set to "SERVICE INTERVALS", push the  switch ② for approximately 10 seconds to display the mileage before service (distance or time to the next service). When the distance value approaches its limit, there are several possible scenarios:

- Distance/time remaining is less than 1,500 km (932 miles) or one month: the message "Service" is displayed accompanied by the nearest term (distance or time);
- Distance equals 0 km or date of service reached: the message "Service required" is displayed and depending on the variants accompanied by the service indicator light (see "Service indicator light" (P.2-14)).

The vehicle requires a service as soon as possible.

Resetting:

To reset the distance before service, push and hold the  switch ② for approximately 10 seconds until the display shows the service mileage without flashing.

NOTE:

If a service is performed without changing the engine oil, only the mileage before the next service should be reset. In the event of an oil change, both the distance before the next service and the next oil change should be reset.

CLOCK AND OUTSIDE AIR TEMPERATURE

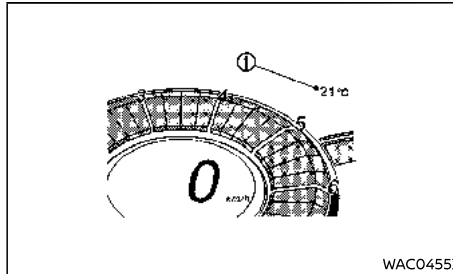

The outside air temperature ① is displayed on the upper right side of the vehicle information display.

The outside air temperature is displayed in °C.

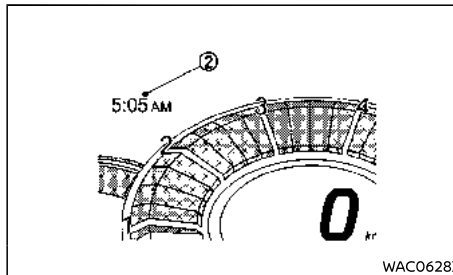

The clock ② is displayed on the upper left side of the vehicle information display.

VEHICLE INFORMATION DISPLAY (type B)

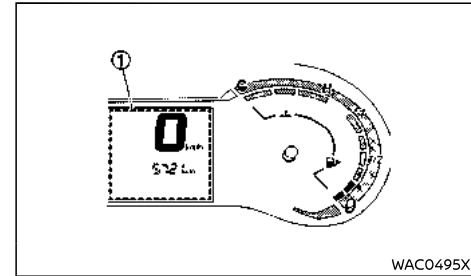

The vehicle information display ① is located on the center of the meter panel. The following items are displayed if the vehicle is equipped with them.

- Speedometer
 - "Speedometer" (P.2-5)
- Odometer/trip odometer/distance to empty
 - "Odometer/trip odometer/distance to empty" (P.2-6)
- Trip computer
 - "Trip computer" (P.2-19)
- Gear shift indicator
 - "Gear shift indicator" (P.5-14)
- Continuously Variable Transmission (CVT) position indicator
 - "Continuously Variable Transmission (CVT) position indicator" (P.2-8)
- Display messages
 - Information messages
 - Operating fault messages
 - Warning messages

TRIP COMPUTER

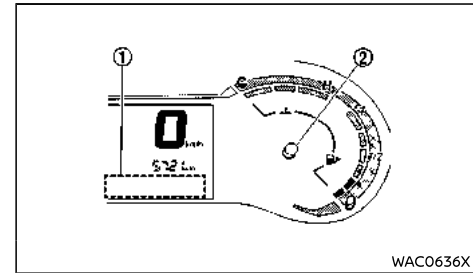
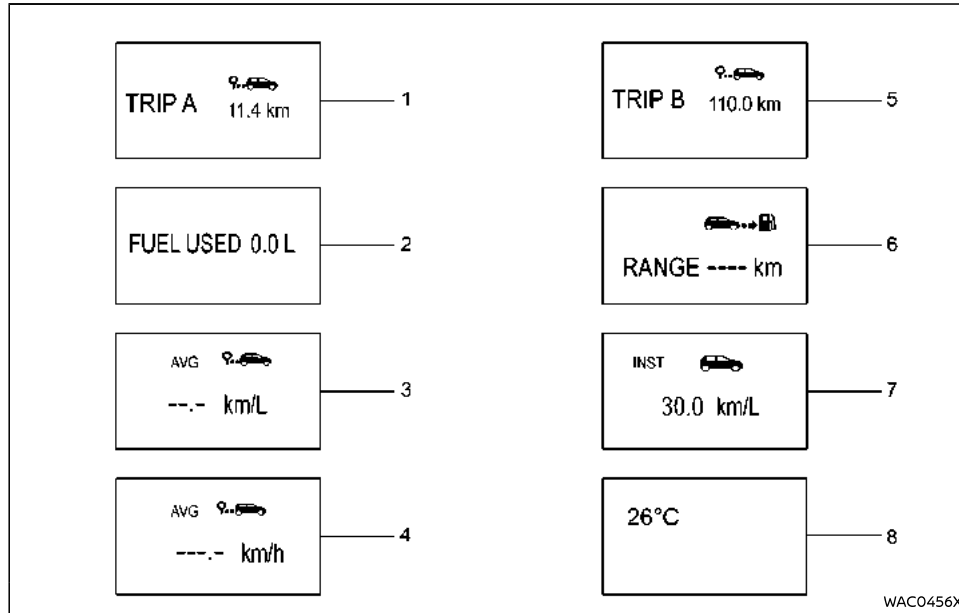

The trip computer display ① can be changed using the trip computer mode switch ② located on the meter panel.

Navigate through the items in the vehicle information display.

Push the switch ② to change the display as follows:

1 → 2 → 3 → 4 → 5 → 6 → 7 → 8 (if equipped) → 1

1. Trip odometer A

The trip odometer displays the distance of individual trip.

2. Fuel used (L)

The fuel used mode shows the amount of the fuel consumed since the last reset.

3. Average fuel consumption (AVG. km/L)

The average fuel consumption mode shows the average fuel consumption since the last reset.

The display is updated every 30 seconds. At about the first 500 m (1/3 miles) after a reset, the display shows "----".

4. Average speed since last reset (km/h)

The average speed mode shows the average vehicle speed since the last reset.

5. Trip odometer B

The trip odometer displays the distance of individual trip.

6. Distance to empty (dte - km)

The distance to empty (dte) mode provides you with an estimation of the distance that can be driven before refueling. The dte is constantly being calculated, based on the amount of fuel in the fuel tank and the actual fuel consumption.

7. Instant fuel consumption (INST km/L)

The instant fuel consumption mode shows the current fuel consumption.

8. Outside air temperature (if equipped)

The outside air temperature mode shows the current external temperature.

Resetting trip computer

To reset the trip computer items, select an item and push and hold the trip computer mode switch ② until the relevant item is reset.

HEADLIGHT AND TURN SIGNAL SWITCH



CAUTION:

Do not leave the lights on when the engine is not running for extended periods of time to prevent the battery from being discharged.

HEADLIGHT SWITCH

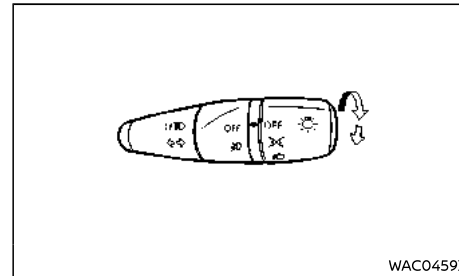

NISSAN recommends that you consult the local regulations concerning the use of lights.

Ⓔ position

The Ⓔ position turns on the front clearance, instrument panel, tail and license plate lights.

Ⓕ position

The Ⓕ position turns on the headlights in addition to the other lights.

Headlight beam

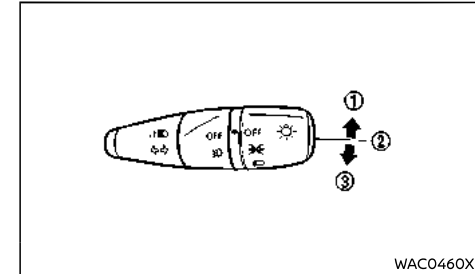

To turn on the high beam, push the lever towards the front position ①.

To turn off the high beam, return the lever to the neutral position ②.

To flash the headlights, pull the lever towards the rearmost position ③. The headlights can be flashed even when the headlights are not on.

If equipped, when the lever is pulled towards the rearmost position ③ after the ignition switch is placed in the "OFF" or "LOCK" position, the headlight will turn on and stay on for 30 seconds. The lever can be pulled 4 times for up to 2 minutes.

Daytime running light system (if equipped)

The daytime running lights automatically illuminate when the engine is started with the parking brake released. The daytime running lights operate with the headlight switch in the OFF position or in the Ⓔ position. Turn the headlight switch to the Ⓕ position for full illumination when driving at night.

If the parking brake is applied before the engine is started, the daytime running lights do not illuminate. The daytime running lights illumi-

nate once the parking brake is released. The daytime running lights will remain on until the ignition switch is placed in the "OFF" position.

HEADLIGHT AIMING CONTROL

Manual type

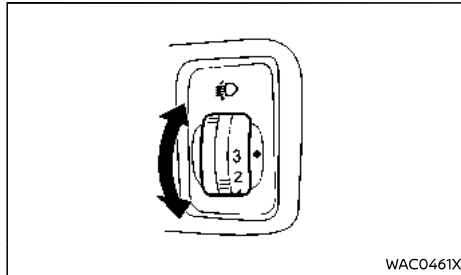

The headlight aiming control operates when the ignition switch is in the "ON" position and the headlight is on to allow the headlight axis to be adjusted according to the driving condition.

When driving with no heavy load/luggage or driving on a flat road, select the normal position "0".

If the number of occupants and load/luggage in the vehicle changes, the headlight axis may become higher than normal.

If the vehicle is traveling on a hilly road, the headlights may directly shine on the rearview and outside mirrors of a vehicle ahead or the windshield of an oncoming vehicle, which may obscure other drivers' vision.

To adjust to the proper aiming height, turn the switch accordingly. The higher the number, designated on the switch, the lower the headlight axis.

Select the switch position by referring to the following samples.

Switch position	Number of front seat occupants	Number of rear seat occupants	Weight of load in luggage compartment
0	1 or 2	No occupants	No load
1	2	3	No load
1	2	3	Full load
2	1	No occupants	Full load

TURN SIGNAL SWITCH

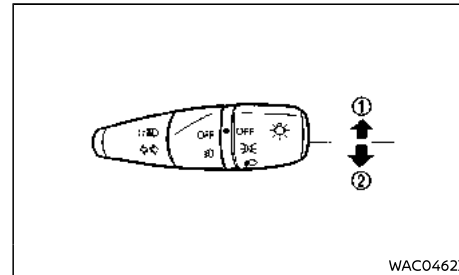

CAUTION:

The turn signal switch will not be cancelled automatically if the steering wheel turning angle does not exceed the preset amount.

Turn signal

To turn on the turn signals, move the lever up ① or down ② to the point where the lever latches. When the turn is completed, the turn signal to be manually deactivated by driver with lever on the center position.

FOG LIGHT SWITCH (if equipped)

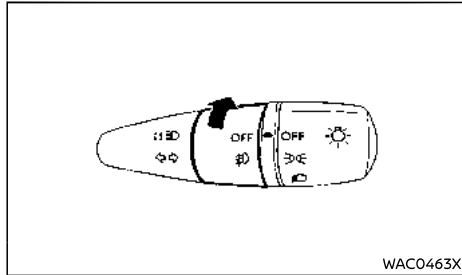

FRONT FOG LIGHTS

To turn on the front fog lights, turn the headlight switch to the or position, then turn the fog light switch to the position. The front fog lights and the indicator light on the instrument panel illuminate.

To turn the front fog lights off, turn the fog light switch to the OFF position.

NOTE:

- If the headlight switch is turned to the OFF position, the front fog lights will turn off automatically.

WIPER AND WASHER SWITCH

WARNING:

In freezing temperatures, the washer fluid may freeze on the windshield and obscure your vision. Warm the windshield with the defogger before you wash the windshield.

CAUTION:

- Do not operate the washer continuously for longer than 30 seconds.
- Do not operate the washer if the window washer fluid reservoir is empty.
- If the wiper operation is interrupted by snow or ice, the wiper may stop moving to protect its motor. If this occurs, turn the wiper switch to the "OFF" position and remove the snow or ice on and around the wiper arms. In approximately 1 minute, turn the switch on again to operate the wiper.

WINDSHIELD WIPER AND WASHER SWITCH

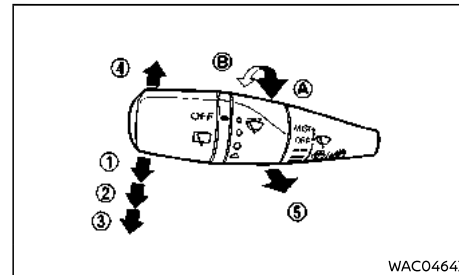

The windshield wiper and washer operate when the ignition switch is in the "ON" position.

Wiper operation

The lever position ① operates the wiper intermittently.

- The intermittent operation can be adjusted by turning the adjustment control knob, (longer) ② or (shorter) ③.
- The intermittent operation speed varies in accordance with the vehicle speed. (For example, when the vehicle speed is high, the intermittent operation speed will be faster.)

The lever position ④ operates the wiper at low speed.

The lever position ⑤ operates the wiper at high speed.

To stop the wiper operation, move the lever up to the "OFF" position.

The lever position "MIST" ⑥ operates the wiper one sweep. The lever automatically returns to its original position.

Washer operation

To operate the washer, pull the lever toward the back of the vehicle ⑦ until the desired amount of washer fluid is spread on the windshield. The wiper will automatically operate one time or several times.

Wiper drip wipe system:

The wiper will also operate once about 3 seconds after the washer and wiper are operated. This operation is to wipe washer fluid that has dripped on the windshield.

REAR WINDOW WIPER AND WASHER SWITCH

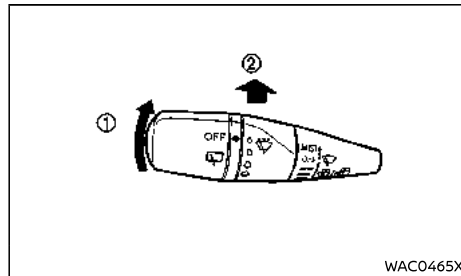

The rear window wiper and washer operates when the ignition switch is in the "ON" position.

Wiper operation

The switch position "  " ① operates the wiper intermittently.

If the rear window wiper operation is interrupted by snow or ice, the wiper may stop moving to protect its motor. If this occurs, turn the wiper switch to the "OFF" position and remove the snow or ice on and around the wiper arms. In approximately 1 minute, turn the switch on again to operate the wiper.

Washer operation

To operate the washer, turn the switch to the position "  " ② until the desired amount of washer fluid is spread on the windshield. The wiper will automatically operate several times.

DEFOGGER SWITCH

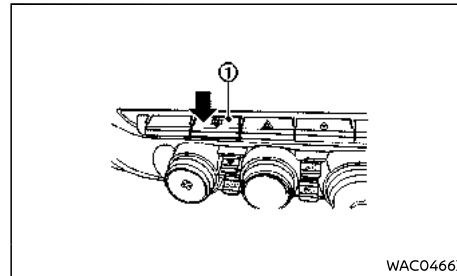

The defogger switch operates when the engine is running.

The defogger is used to reduce the moisture, fog or frost on the rear window surface to improve the rear views.

When the defogger switch ① is pushed, the indicator light on the switch illuminates and the defogger operates for approximately 10 minutes. After the preset time has passed, the defogger will turn off automatically.

To turn off manually, push the defogger switch again.



CAUTION:

When cleaning the inner side of the window, be careful not to scratch or damage the electrical conductors on the surface of the window.

HORN

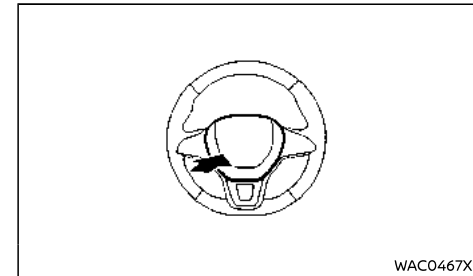

The horn switch operates regardless of the ignition switch position except when the battery is discharged.

When the horn switch is pushed and held, the horn will sound. Releasing the horn switch will cease the horn sound.

WINDOWS

POWER WINDOWS



WARNING:

- Make sure that all passengers have their hands, etc. inside the vehicle before operating the power windows.
- To help avoid risk of injury or death through unintended operation of the vehicle and or its systems, including entrapment in windows or inadvertent door lock activation, do not leave children, people who require the assistance of others or pets unattended in your vehicle. Additionally, the temperature inside a closed vehicle on a warm day can quickly become high enough to cause a significant risk of injury or death to people and pets.

The power windows operate when the engine is running (for Intelligent Key models) or the ignition switch is in the "ON" position (except for Intelligent Key models).

To open a window, push down the power window switch.

To close a window, pull up the power window switch.

Driver's window switch

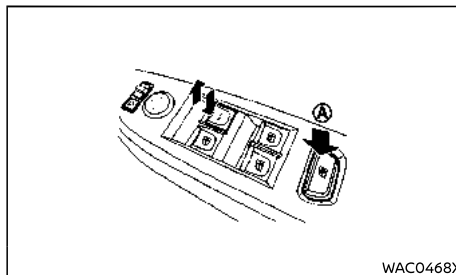

WAC0468X

The driver's switch, the main switch, can control all windows.

Locking rear passengers' windows:

When the lock button **A** is pushed in, the rear passengers' windows cannot be operated.

To cancel the rear passengers' windows lock, push the lock button **A** again.

Passenger's window switch

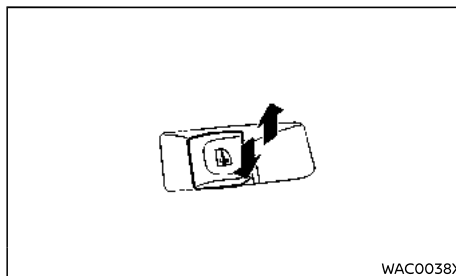

WAC0038X

The passenger's switch can control its corresponding window.

When the rear passengers' windows lock but-

ton on the driver's switch is pushed in, the rear passenger's switch cannot be operated.

Automatic function (if equipped)

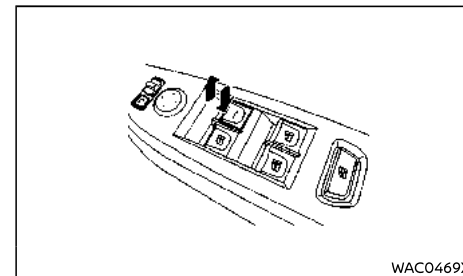

WAC0469X

The automatic function is available for the switch that has an AUTO mark on its surface.

The automatic function enables a window to fully open or close without holding the switch down or up.

To fully open the window, push the power window switch down to the second detent and release the switch. To fully close the window, pull the power window switch up to the second detent and release the switch. The switch does not have to be held during window operation.

To stop the window open/close operation during the automatic function, push down or pull up the switch in opposite directions.

Window timer:

The window timer allows the window switch to be operated for a period of time even if the ignition switch is placed in the "OFF" or "LOCK" position. The window timer will be canceled when the driver's door is opened or the preset time has expired.

Auto-reverse function:



WARNING:

There is a small distance just before the closed position which cannot be detected. Make sure that all passengers have their hands, etc. inside the vehicle before closing the windows.

The auto-reverse function enables a window to automatically reverse when something is caught in the window as it is closing by the automatic function. When the control unit detects an obstacle, the window will be lowered immediately.

Depending on the environment or driving conditions, the auto-reverse function may activate if an impact or load similar to something being caught in the window occurs.

If the window does not close automatically

If the power window automatic function (closing only) does not operate properly, perform the following procedure to initialize the power window system.

1. Start the engine.
2. Close the door.
3. After starting the engine, open the window completely by operating the power window switch.
4. Pull the power window switch and hold it to close the window, and then hold the switch more than 3 seconds after the window is closed completely.
5. Release the power window switch. Operate the window by the automatic function to confirm the initialization is complete.

If the power window automatic function does

not operate properly after performing the procedure above, have your vehicle checked by a NISSAN dealer.

POWER OUTLET

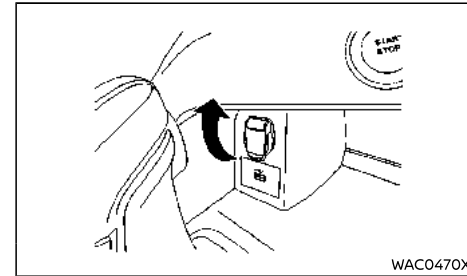

Front

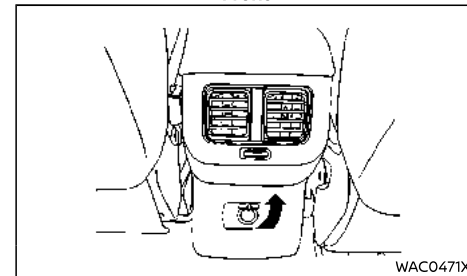

Rear (if equipped)

To use the power outlet, pull up the cover as illustrated.



CAUTION:

- The outlet and plug may be hot during or immediately after use.
- This power outlet is not designed for use with a cigarette lighter unit.
- Do not use with accessories that exceed a 12 volt, 120W (10A) power draw. Do not use double adapters or more than one electrical accessory.

- Use power outlet with the engine running to avoid discharging the vehicle battery.
- Avoid using power outlet when the air conditioner, headlights or rear window defogger is on.
- Before inserting or disconnecting a plug, be sure to turn off the power switch of the electrical accessory being used and the ignition switch.
- Push the plug in as far as it will go. If good contact is not made, the plug may over-heat or the internal temperature fuse may blow.
- Do not allow water to contact the outlet.
- When not in use, be sure to close the cap.

STORAGE

WARNING:

- The storages should not be used while driving so that the full attention may be given to vehicle operation.
- Keep the storage lids closed while driving to help prevent injury in an accident or sudden stop.

GLOVE BOX

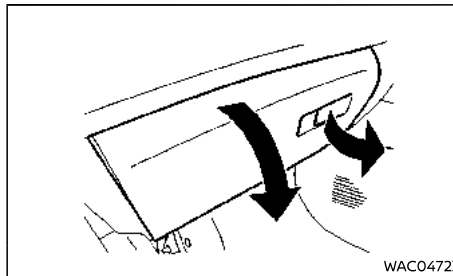

To open the glove box, pull the handle.
To close, push the lid in until the lock latches.

CARD HOLDER

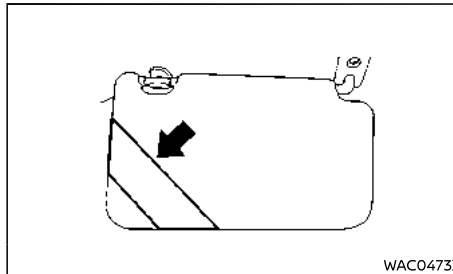

The card holder is located on the driver's sun visor.

To use the card holder, slide a card in the card holder.

CUP HOLDERS

WARNING:

The driver must not remove or insert cups into the cup holder while driving so that full attention may be given to vehicle operation.

CAUTION:

Avoid abrupt starting and braking especially when the cup holder is being used to prevent spilling the contents. If the contents are hot, they could scald you or your passengers.

Front

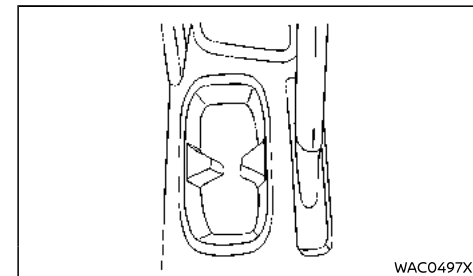

Key communication symbol:

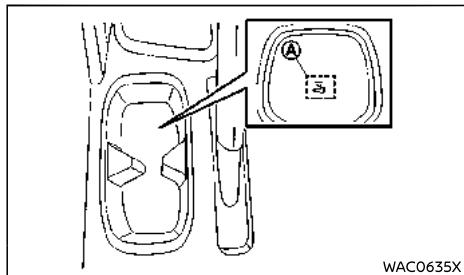

A "key communication symbol" (A) is stamped on the bottom of the front cup holder. For models with the Intelligent Key system, this means that the Intelligent Key antenna receiver is placed under the center console. (See "Intelligent Key battery discharge" (P.5-8).)

Rear (if equipped)

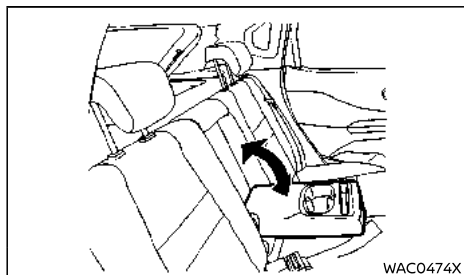

Pull the armrest down as shown.

Soft bottle holder

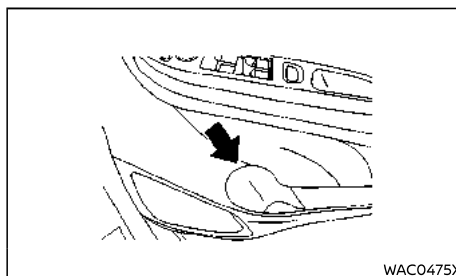

Front

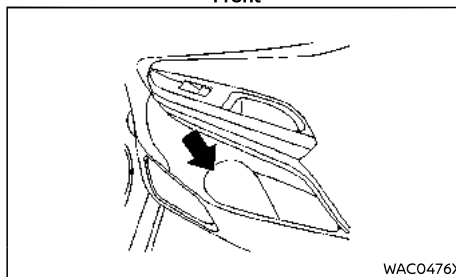

Rear

Soft bottle holders are located on the front and rear doors.

CAUTION:

- Do not use bottle holder for any other objects that could be thrown about in the vehicle and possibly injure people during sudden braking or an accident.
- Do not use bottle holder for open liquid containers.

CARGO COVER (if equipped)

WARNING:

- Never put anything on the cargo cover, no matter how small. Any object on it could cause an injury in an accident or sudden stop.
- Do not leave the cargo cover in the vehicle with it disengaged from the holder.
- The child restraint top tether strap may be damaged by contact with the cargo cover or items in the luggage area. Remove the cargo cover from the vehicle or secure it and any luggage. Your child could be seriously injured or killed in a collision if the top tether strap is damaged.
 - If the cargo cover contacts the top tether strap when it is attached to the top tether anchor, remove the cargo cover from the vehicle or secure it on the cargo floor below its attachment location. If the cargo cover is not removed, it may damage the top tether strap during a collision.
 - Do not allow cargo to contact the top tether strap when it is attached to the top tether anchor. Properly secure the cargo so it does not contact the top tether strap. Cargo that is not properly secured or that contacts the top tether strap may damage the top tether strap during a collision.

The cargo cover keeps the luggage compartment contents hidden from the outside.

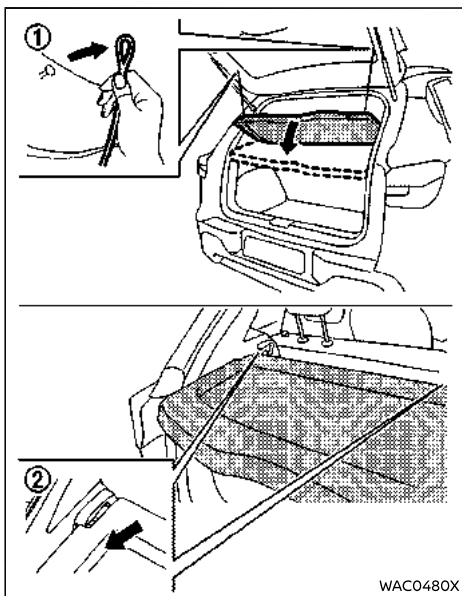

To remove the cargo cover:

1. Remove the straps ① from the back door.
2. Remove the cargo cover from the holders ②.

LUGGAGE HOOKS

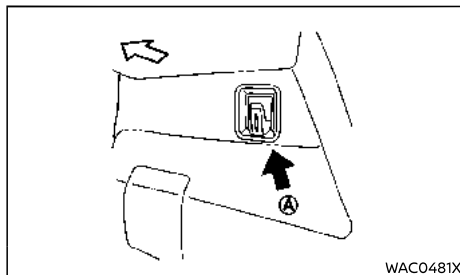

The luggage hooks ① are located in the luggage area.

⚠ CAUTION:

- Always make sure that the luggage is properly secured. Use the suitable ropes and hooks.
- Unsecured luggage can become dangerous in an accident or sudden stop.
- Do not apply a total load of more than 3 kg (7 lb) to a single hook ①.

COAT HOOK

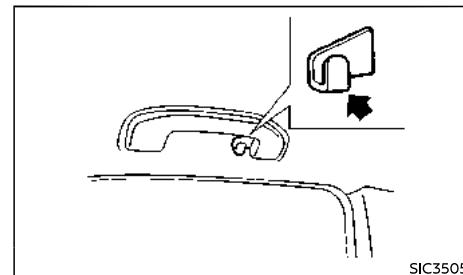

The coat hooks are located above the rear side windows.

⚠ CAUTION:

- Do not apply a total load of more than 1 kg (2 lb) to the hook.

ROOF RACK

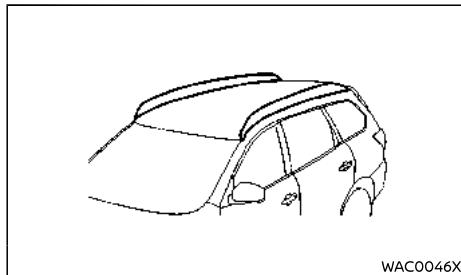

WAC0046X

Do not apply any load directly to the roof side rails. Cross bars must be installed before applying load/cargo/luggage to the roof of the vehicle.

Concerning cross bars, it is recommended that you visit a NISSAN dealer for additional information.

The service load capacity for the roof side rails is 50 kg (110 lb), however do not exceed the accessory cross bars load capacity.



WARNING:

- Always install the cross bars onto the roof side rails before loading cargo of any kind. Loading cargo directly onto the roof side rails or the vehicle's roof may cause vehicle damage.
- Drive extra carefully when the vehicle is loaded at or near the cargo carrying capacity, especially if the significant portion of that load is carried on the roof rack.
- Heavy loading of the roof rack has the potential to affect the vehicle stability and handling during sudden or unusual handling maneuvers.

- Roof rack load should be evenly distributed.
- Do not exceed maximum roof rack load weight capacity.
- Properly secure all cargo with ropes or straps to help prevent it from sliding or shifting. In a sudden stop or collision, unsecured cargo could cause personal injury.

SUN VISORS

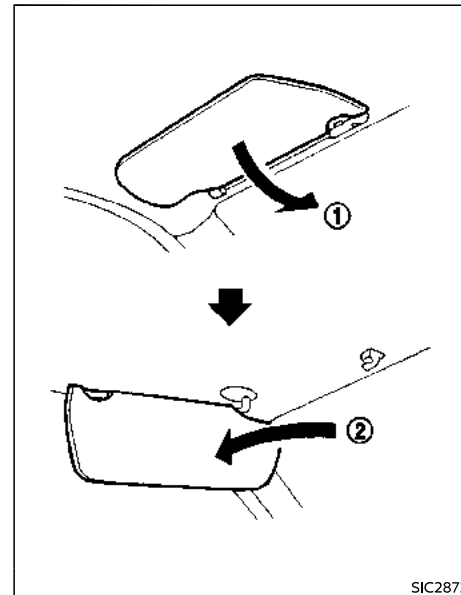

SIC2872

1. To block out glare from the front, swing down the sun visor towards windshield and park it parallel to windshield ①.
2. To block glare from the side, remove the sun visor from the center mount and swing it to the side ②.

INTERIOR LIGHTS



CAUTION:

- Do not leave the light switch on when the engine is not running for extended periods of time to prevent the battery from being discharged.
- Turn off the lights when you leave the vehicle.

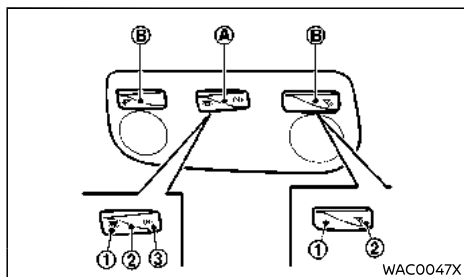

Front

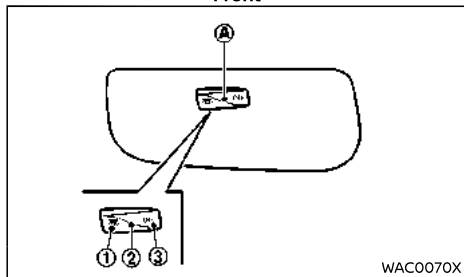

Rear

FRONT AND REAR ROOM LIGHT

Models with door position linkage function

The room light has a three-position switch A.

When the switch is in the "ON" position ①, the room light illuminates.

When the switch is in the "DOOR" position ②, the room light illuminates when a door is opened.

The interior light timer will keep the room light on for a period of time when:

- The key is removed from the ignition switch with the driver's door closed. (model without Intelligent Key system)
- The ignition switch is placed in the "LOCK" position. (model with Intelligent Key system)
- The doors are unlocked by pushing the "UNLOCK"  button (remote keyless entry system or Intelligent Key system equipped models) or the request switch (Intelligent Key system equipped models), with the ignition switch in the "LOCK" position.
- Any door is opened and then closed with the ignition switch in the "LOCK" position and without the key in the ignition switch. (model without Intelligent Key system)
- Any door is opened and then closed with the ignition switch in the "LOCK" position. (model with Intelligent Key system)

The interior light timer will be cancelled when:

- The driver's door is locked.
- The ignition switch is placed in the "ON" position.

When the switch is in the "OFF" position ③, the room light does not illuminate, regardless of any condition.

Models without door position linkage function

When the switch is in the "ON" position ①, the room light illuminates.

When the switch is in the "OFF" position ③, the room light does not illuminate.

FRONT MAP LIGHTS

To turn on the front map light ②, push the on switch ②, and the light illuminates. To turn off, push the off switch ①.

CARGO ROOM LIGHT (if equipped)

The cargo room light illuminates when the back door is opened. When the back door is closed, the light will turn off.

3 Pre-driving checks and adjustments

Keys	3-2	Using remote keyless entry system	3-11
NISSAN Anti-Theft System (NATS) key (if equipped)	3-2	Hazard indicator operation	3-11
Intelligent Key (if equipped)	3-2	Security system	3-13
Doors	3-3	Theft warning system (if equipped)	3-13
Locking with key	3-3	NISSAN Anti-Theft System (NATS)	3-13
Locking with inside lock knob	3-4	Hood	3-14
Locking and unlocking with power door lock switch (if equipped)	3-4	Opening hood	3-15
Vehicle speed sensing door lock mechanism (if equipped)	3-4	Closing hood	3-15
Impact sensing door lock releasing mechanism (if equipped)	3-4	Back door	3-15
Child safety rear door lock	3-4	Opening back door	3-16
Remote keyless entry system (if equipped)	3-5	Closing back door	3-16
Using remote keyless entry system	3-5	Fuel-filler lid	3-17
Intelligent Key system (if equipped)	3-6	Opening fuel-filler lid	3-17
Intelligent Key operating range	3-7	Fuel-filler cap	3-17
Using Intelligent Key system	3-7	Steering wheel	3-17
Battery saver system	3-9	Tilt operation	3-17
Warning and audible reminders	3-9	Mirrors	3-18
Troubleshooting guide	3-10	Inside rearview mirror	3-18
		Outside rearview mirrors	3-18
		Vanity mirror	3-19
		Parking brake	3-19



KEYS

Your vehicle can only be driven with the keys specific to your vehicle. A key number plate is supplied with your key (if equipped). Record the key number and keep the key number plate in a safe place, except in the vehicle, in case of the need to duplicate the keys.

The key can only be duplicated using an original key or the original key number. The key number is required when you have lost all of the keys and do not have the original key to duplicate from. If the key is lost, or you need extra keys, provide an original key or the key number to a NISSAN dealer.



CAUTION:

Do not leave the keys inside the vehicle when leaving the vehicle.

NISSAN ANTI-THEFT SYSTEM (NATS*) KEY (if equipped)

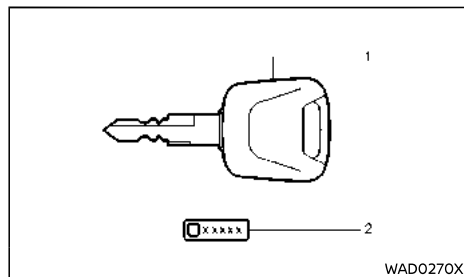

Type A

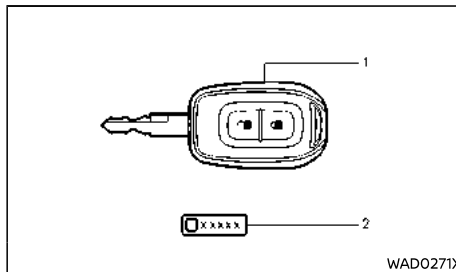

Type B

- 1 NATS key (2)
- 2 Key number plate (if equipped)

Your vehicle can only be driven with the NATS keys, which are registered to your vehicle's NATS components. As many as 4 NATS keys can be registered and used with one vehicle. The new keys must be registered by a NISSAN dealer prior to use with the NATS of your vehicle. Since the registration process requires erasing all memory in the NATS components when registering new keys, be sure to take all NATS keys that you have to the NISSAN dealer.



CAUTION:

Do not allow the NATS key, which contains an electrical transponder, to come into contact with water or salt water. This could affect the system function.

*: Immobilizer

INTELLIGENT KEY (if equipped)

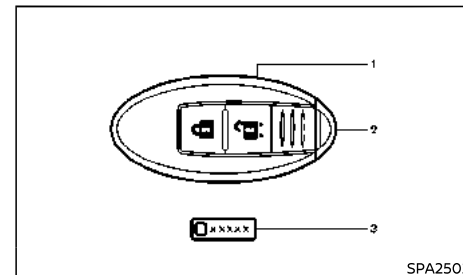

1. Intelligent Key (2)
2. Mechanical key (inside the Intelligent Key) (2)
3. Key number plate (if equipped)

Your vehicle can only be driven with the Intelligent Keys, which are registered to your vehicle's Intelligent Key system components and NISSAN Anti-Theft System (NATS*) components. As many as 4 Intelligent Keys can be registered and used with one vehicle. The new keys must be registered by a NISSAN dealer prior to use with the Intelligent Key system and NATS of your vehicle. Since the registration process requires erasing all memory in the Intelligent Key components when registering new keys, be sure to take all Intelligent Keys that you have to the NISSAN dealer.

*: Immobilizer



CAUTION:

- **Be sure to carry the Intelligent Key with you. Do not leave the vehicle with the Intelligent Key inside.**

- Be sure to carry the Intelligent Key with you when driving. The Intelligent Key is a precision device with a built-in transmitter. To avoid damaging it, please note the following.
 - The Intelligent Key is water resistant; however, wetting may damage the Intelligent Key. If the Intelligent Key gets wet, immediately wipe until it is completely dry.
 - Do not bend, drop or strike it against another object.
 - If the outside temperature is below -10°C (14°F), the battery of the Intelligent Key may not function properly.
 - Do not place the Intelligent Key for an extended period in a place where temperatures exceed 60°C (140°F).
 - Do not change or modify the Intelligent Key.
 - Do not use a magnet key holder.
 - Do not place the Intelligent Key near equipment that produces a magnetic field such as a TV, audio equipment and personal computers.
 - Do not allow the Intelligent Key to come into contact with water or salt water, and do not wash it in a washing machine. This could affect the system function.
- If an Intelligent Key is lost or stolen, NISSAN recommends erasing the ID code of that Intelligent Key. This will prevent the Intelligent Key from unauthorized use to unlock the vehicle. For information regarding the erasing procedure, please contact a NISSAN dealer.

Mechanical key

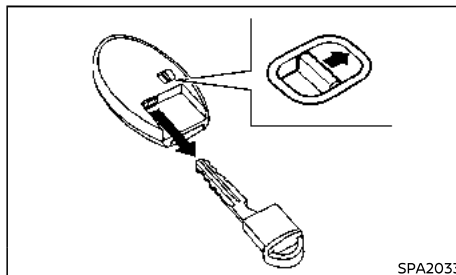

To remove the mechanical key, push the lock knob at the side of the Intelligent Key.

To install the mechanical key, firmly insert it into the Intelligent Key until the lock knob returns to the lock position.

Use the mechanical key to lock or unlock the driver's doors. (See "Doors" (P.3-3).)

DOORS



WARNING:

- Always look before opening any doors, to avoid an accident with oncoming traffic.
- To help avoid risk of injury or death through unintended operation of the vehicle and or its systems, including entrapment in windows or inadvertent door lock activation, do not leave children, people who require the assistance of others or pets unattended in your vehicle. Additionally, the temperature inside a closed vehicle on a warm day can quickly become high enough to cause a significant risk of injury or death to people and pets.

LOCKING WITH KEY

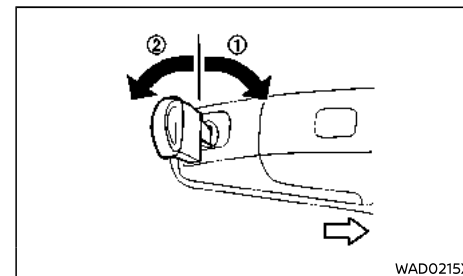

To lock the driver's door, insert the key to the door cylinder and turn the key clockwise ①.

To unlock the driver's door, turn the key counterclockwise ②.

To lock or unlock the other doors, use the power door lock switch (if equipped), the remote controller (if equipped) or the Intelligent Key (if equipped).

LOCKING WITH INSIDE LOCK KNOB

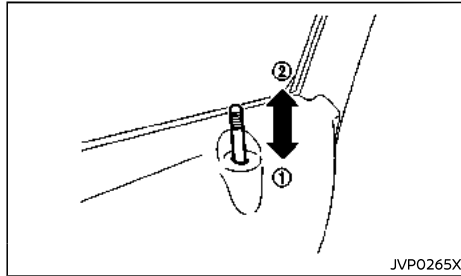

To lock the door, push the inside lock knob to the lock position ①.

To unlock, pull the inside lock knob to the unlock position ②.

LOCKING AND UNLOCKING WITH POWER DOOR LOCK SWITCH (if equipped)

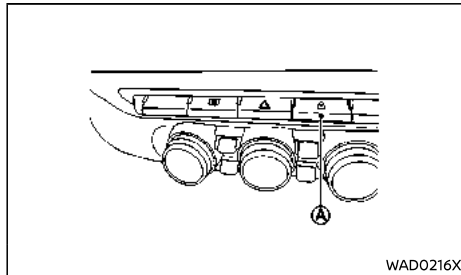

Operating the power door lock switch ④, located on the instrument panel, will lock or unlock all the doors.

To lock the doors, push the power door lock

switch with all doors closed. All doors will be locked.

CAUTION:

- When locking the doors using the power door lock switch, be sure not to leave the key in the vehicle.
- When the Intelligent Key (if equipped) is left in the vehicle while the driver's door is opened and you try to lock the door using the power door lock switch after getting out of the vehicle, all the doors will unlock automatically after the power door lock switch is operated.

To unlock, push the power door lock switch ④ again with all doors closed. All doors will be unlocked.

VEHICLE SPEED SENSING DOOR LOCK MECHANISM (if equipped)

All doors will be locked automatically when the vehicle speed reaches 7 km/h (4 MPH). Once the lock has been unlocked, while driving, the vehicle speed sensing door lock mechanism will not lock the door again unless the following is performed.

- Reducing vehicle speed below 7 km/h (4 MPH)

To activate or deactivate vehicle speed sensing door lock mechanism

To activate or deactivate the vehicle speed sensing door lock mechanism, perform the following procedures.

- With the engine running, push and hold the power door lock switch for 5 seconds.

IMPACT SENSING DOOR LOCK RELEASING MECHANISM (if equipped)

All doors will be unlocked automatically when the impact sensors sense an impact while the ignition switch is in the "ON" position.

CHILD SAFETY REAR DOOR LOCK

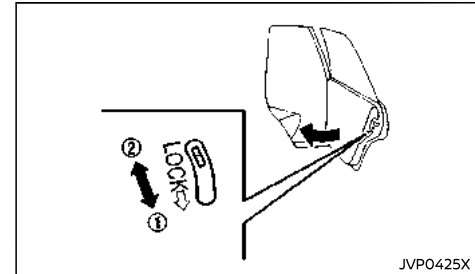

The child safety rear door locks help prevent rear doors from being opened accidentally, especially when small children are in the vehicle.

When the lever is in the lock position ①, the child safety rear door lock engages and the rear door can only be opened by the outside door handle.

To disengage, move the lever to the unlock position ②.

REMOTE KEYLESS ENTRY SYSTEM (if equipped)

The remote keyless entry system can operate all door locks using the remote controller. The remote controller can operate at a distance of approximately 1 m (3.3 ft) away from the vehicle. The operating distance depends upon the conditions around the vehicle.

As many as 4 remote controllers can be used with one vehicle. For information about the purchase and use of additional remote controllers, contact a NISSAN dealer.

The remote controller will not function under the following conditions:

- When the distance between the remote controller and vehicle is more than approximately 1 m (3.3 ft).
- When the remote controller battery is discharged.
- When the key is in the ignition switch.



CAUTION:

- **When locking the doors using the remote controller, be sure not to leave the key in the vehicle.**
- **Do not allow the remote controller, which contains electrical components, to come into contact with water or salt water. This could affect the system function.**
- **Do not drop the remote controller.**
- **Do not strike the remote controller sharply against another object.**
- **If the outside temperature is below -10°C (14°F), the battery of the remote controller may not function properly.**
- **Do not place the remote controller for an extended period in an area where temperatures exceed 60°C (140°F).**

If a remote controller is lost or stolen, NISSAN

recommends erasing the ID code of that remote controller from the vehicle. This may prevent the unauthorized use of the remote controller to unlock the vehicle. For information regarding the erasing procedure, contact a NISSAN dealer.

For information regarding the replacement of a battery, see "Remote controller battery" (P.8-17).

USING REMOTE KEYLESS ENTRY SYSTEM

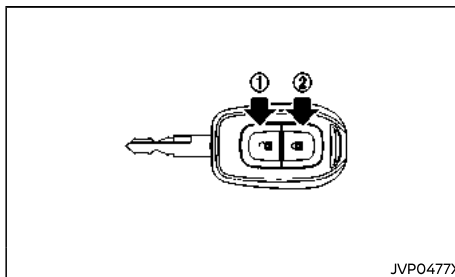

- ① UNLOCK button
- ② LOCK button

Locking doors

1. Remove the key from the ignition switch.
2. Close all doors.
3. Push the "LOCK" button ② on the remote controller.
4. All doors will be locked.
5. Operate door handles to confirm that the doors have been securely locked.



CAUTION:

After locking the doors using the remote controller, be sure that the doors have been securely locked by operating the door handles.

Unlocking doors

1. Push the "UNLOCK" button ① on the remote controller.
2. All doors will be unlocked.

All doors will be locked automatically unless one of the following operations is performed within 2 minutes after pushing the "UNLOCK" button ①.

- Opening any doors.
- Inserting the key into the ignition switch.

Hazard indicator operation

When you lock or unlock the doors, the hazard indicator will flash as a confirmation.

- "LOCK": The hazard indicator flashes twice.
- "UNLOCK": The hazard indicator flashes once.

INTELLIGENT KEY SYSTEM (if equipped)



WARNING:

- **Radio waves could adversely affect electric medical equipment. Those who use a pacemaker should contact the electric medical equipment manufacturer for the possible influences before use.**
- **The Intelligent Key transmits radio waves when the buttons are pushed. The radio waves may affect aircraft navigation and communication systems. Do not operate the Intelligent Key while on an airplane. Make sure the buttons are not operated unintentionally when the unit is stored during a flight.**

The Intelligent Key system can operate all the doors and the back door using the remote controller function or pushing the request switch on the vehicle without taking the key out from a pocket or purse. The operating environment and/or conditions may affect the Intelligent Key system operation.

Be sure to read the following before using the Intelligent Key system.



CAUTION:

- **Be sure to carry the Intelligent Key with you when operating the vehicle.**
- **Never leave the Intelligent Key in the vehicle when you leave the vehicle.**

The Intelligent Key is always communicating with the vehicle as it receives radio waves. The Intelligent Key system transmits weak radio waves. Environmental conditions may interfere with the operation of the Intelligent Key system under the following operating conditions.

- When operating near a location where strong radio waves are transmitted, such as a TV tower, power station and broadcasting station.
- When in possession of wireless equipment, such as a cellular telephone, transceiver, and CB radio.
- When the Intelligent Key is in contact with or covered by metallic materials.
- When any type of radio wave remote control is used nearby.
- When the Intelligent Key is placed near an electric appliance such as a personal computer.

In such cases, correct the operating conditions before using the Intelligent Key function or use the mechanical key.

Although the life of the battery varies depending on the operating conditions, the battery's life is approximately 2 years. If the battery is discharged, replace it with a new one.

For information regarding replacement of a battery, see "Intelligent Key battery" (P.8-18).

Since the Intelligent Key is continuously receiving radio waves, if the key is left near equipment which transmits strong radio waves, such as signals from a TV and personal computer, the battery life may become shorter.

Because the steering wheel is locked electrically, unlocking the steering wheel with the ignition switch in the "LOCK" position is impossible when the vehicle battery is completely discharged. Pay special attention that the vehicle battery is not completely discharged.

As many as 4 Intelligent Keys can be registered and used with one vehicle. For information about the purchase and use of additional Intelligent Keys, contact a NISSAN dealer.



CAUTION:

- **Do not allow the Intelligent Key, which contains electrical components, to come into contact with water or salt water. This could affect the system function.**
- **Do not drop the Intelligent Key.**
- **Do not strike the Intelligent Key sharply against another object.**
- **Do not change or modify the Intelligent Key.**
- **Wetting may damage the Intelligent Key. If the Intelligent Key gets wet, immediately wipe until it is completely dry.**
- **If the outside temperature is below -10°C (14°F), the battery of the Intelligent Key may not function properly.**
- **Do not place the Intelligent Key for an extended period in an area where temperatures exceed 60°C (140°F).**
- **Do not attach the Intelligent Key with a key holder that contains a magnet.**
- **Do not place the Intelligent Key near equipment that produces a magnetic field, such as a TV, audio equipment and personal computers.**

If an Intelligent Key is lost or stolen, NISSAN recommends erasing the ID code of that Intelligent Key from the vehicle. This may prevent the unauthorized use of the Intelligent Key to operate the vehicle. For information regarding the erasing procedure, contact a NISSAN dealer.

The Intelligent Key function can be disabled. For information about disabling the Intelligent Key function, contact a NISSAN dealer.

INTELLIGENT KEY OPERATING RANGE

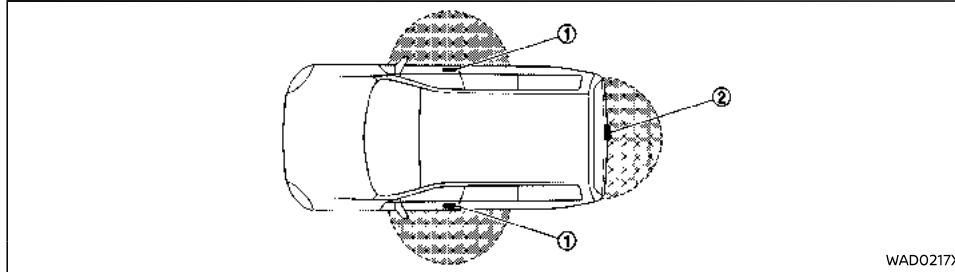

The Intelligent Key functions can only be used when the Intelligent Key is within the specified operating range from the request switch ① or the back door unlock switch ②.

When the Intelligent Key battery is discharged or strong radio waves are present near the operating location, the Intelligent Key system's operating range becomes narrower, and the Intelligent Key may not function properly.

The operating range is within 80 cm (31.50 in) from each request switch ① or the back door unlock switch ②.

If the Intelligent Key is too close to the door glass or door handle, the request switches may not function.

When the Intelligent Key is within the operating range, it is possible for anyone, even someone who does not carry the Intelligent Key, to push the request switch to lock/unlock the doors, including the back door.

USING INTELLIGENT KEY SYSTEM

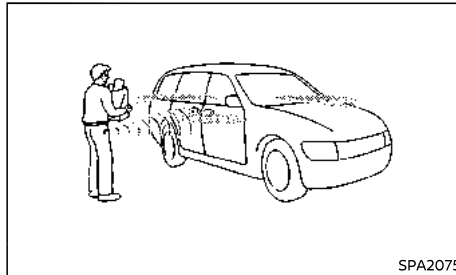

The request switch will not function under the following conditions:

- When another Intelligent Key is left inside the vehicle
- When the Intelligent Key is not within the operational range
- When any door is open or not closed securely
- When the Intelligent Key battery is discharged

- When the ignition switch is in the "ACC" or "ON" position

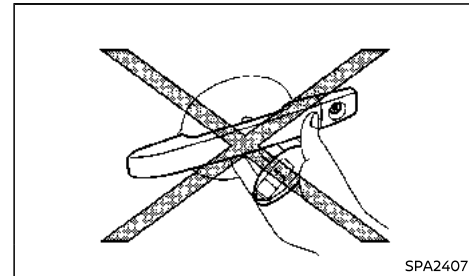

- Do not push the door handle request switch with the Intelligent Key held in your hand as illustrated. The close distance to the door handle will cause the Intelligent Key system to have difficulty recognizing that the Intelligent Key is outside the vehicle.
- After locking the doors using the door handle request switch, make sure that the doors have been securely locked by operating the door handles.
- When locking the doors using the door handle request switch, make sure to have the Intelligent Key in your possession before operating the door handle request switch to prevent the Intelligent Key from being left in the vehicle.
- The door handle request switch is operational only when the Intelligent Key has been detected by the Intelligent Key system.
- Do not pull the door handle before pushing the door handle request switch. The door will be unlocked but will not open. Release the door handle once and pull it again to

open the door.

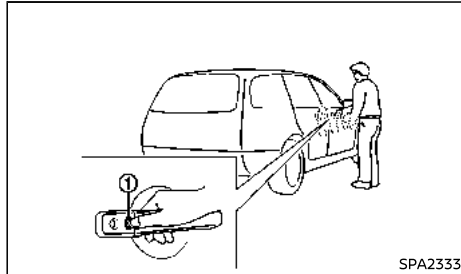

When you carry the Intelligent Key with you, you can lock or unlock all doors by pushing the door handle request switch (driver's or front passenger's) ① within the range of operation.

When you lock or unlock the doors, the hazard indicator will flash as a confirmation. For details, see "Hazard indicator operation" (P.3-11).

Locking doors

1. Push the ignition switch to the "OFF" position.
2. Carry the Intelligent Key with you.
3. Close all doors.
4. Push the door handle request switch ① (driver's or front passenger's door).
5. All doors will be locked.
6. Operate door handles to confirm that the doors have been securely locked.

Lockout protection:

To prevent the Intelligent Key from being accidentally locked in the vehicle, lockout protection is equipped with the Intelligent Key system.

- When the Intelligent Key is left in the vehicle while the driver's door is opened and you try to lock the door using the power door lock switch after getting out of the vehicle, all the doors will unlock automatically after the power door lock switch is operated.



CAUTION:

The lockout protection may not function under the following conditions:

- When the Intelligent Key is placed in the luggage area.
- When the Intelligent Key is placed on top of the instrument panel.
- When the Intelligent Key is placed inside of the glove box.
- When the Intelligent Key is placed inside of the door pockets.
- When the Intelligent Key is placed inside or near metallic materials.

The lockout protection may function when the Intelligent Key is outside the vehicle but is too close to the vehicle.

Unlocking doors

1. Carry the Intelligent Key with you.
2. Push the door handle request switch ① (driver's or front passenger's).
3. All doors will be unlocked.
4. Operate the door handles to open the doors.



CAUTION:

If a door handle is pulled while unlocking the doors, that door may not be unlocked. Returning the door handle to its original position will unlock the door. If the door does not unlock, after returning the door handle, push the door handle request switch to unlock the door.

Automatic relock:

All doors will be locked automatically unless one of the following operations is performed within 2 minutes after pushing the request switch while the doors are locked.

- Opening any doors.
- Pushing the ignition switch.

If during the preset time period the "UNLOCK" button on the Intelligent Key is pushed, all doors will be locked automatically after the next preset time.

Opening back door

See "Back door" (P.3-15).

BATTERY SAVER SYSTEM

When all the following conditions are met for a period of time, the battery saver system will cut off the power supply to prevent battery discharge.

- The ignition switch is in the "ON" position, and
- All doors are closed, and
- The shift lever is in the "P" (Park) position (CVT model) or "N" (Neutral) position (MT model).

WARNING AND AUDIBLE REMINDERS

The Intelligent Key system is equipped with a function that is designed to minimize improper operations of the Intelligent Key and to help prevent the vehicle from being stolen. A chime or beep sounds inside and outside the vehicle and a warning message appears in the vehicle information display.

See the troubleshooting guide on the next page.



CAUTION:

When the chime or beep sounds or the warning message appears, be sure to check both the vehicle and the Intelligent Key.

TROUBLESHOOTING GUIDE

Symptom		Possible cause	Action to take
When pushing the ignition switch to start the engine	The Key Battery low warning (if equipped) appears in the vehicle information display .	The battery charge is low.	Replace the battery with a new one. (See "Intelligent Key battery" (P.8-18).)
	The No Key Detected warning (if equipped) appears in the vehicle information display and the inside warning chime sounds for a few seconds.	The Intelligent Key is not in the vehicle.	Carry the Intelligent Key with you.
When pushing the ignition switch	The Key System Error warning (if equipped) appears in the vehicle information display.	It warns of a malfunction with the electrical steering lock system or the Intelligent Key system.	Contact a NISSAN dealer.

USING REMOTE KEYLESS ENTRY SYSTEM

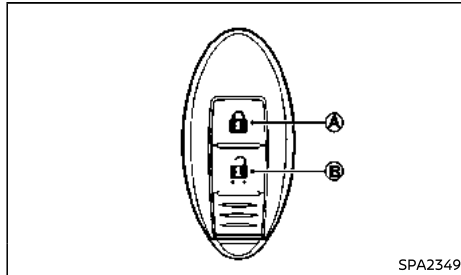

- Ⓐ LOCK button
- Ⓑ UNLOCK button

Operating range

The remote keyless entry system allows you to lock/unlock all doors including the back door. The operating distance depends upon the conditions around the vehicle. To securely operate the "LOCK" and "UNLOCK" buttons, approach the vehicle to about 1 m (3.3 ft) from the door.

The remote keyless entry system will not function under the following conditions:

- When the Intelligent Key is not within the operational range.
- When the Intelligent Key battery is discharged.

For information regarding the replacement of a battery, see "Intelligent Key battery" (P.8-18).

Locking doors

1. Place the ignition switch in the "OFF" position.
2. Carry the Intelligent Key with you.
3. Close all doors (including the back door).
4. Push the "LOCK" button Ⓐ on the Intelligent Key.
5. All doors will be locked.
6. Operate the door handles to confirm that the doors have been securely locked.



CAUTION:

- **After locking the doors using the Intelligent Key, be sure that the doors have been securely locked by operating the door handles.**
- **When locking the doors using the Intelligent Key, be sure not to leave the key in the vehicle.**

Unlocking doors

1. Push the "UNLOCK" button Ⓑ on the Intelligent Key.
2. All doors (including the back door) will be unlocked.

Automatic relock:



All doors will be locked automatically unless one of the following operations is performed within 2 minutes after pushing the "UNLOCK" button Ⓑ on the Intelligent Key while the doors are locked. If during the preset time period the "UNLOCK" button Ⓑ on the Intelligent Key is pushed, all doors will be locked automatically after the next preset time.

- Opening any door or back door.
- Pushing the ignition switch.

HAZARD INDICATOR OPERATION

When you lock or unlock the doors with the request switch or the remote keyless entry function, the hazard indicator will flash as a confirmation.

The following descriptions show how the hazard indicator will activate when locking or unlocking the doors.

Operation	DOOR LOCK	DOOR UNLOCK
Intelligent Key system (using door handle request switch)	HAZARD - twice	HAZARD - once
Remote keyless entry system (using  or  button)	HAZARD - twice	HAZARD - once

SECURITY SYSTEM



WARNING:

- **Do not change or modify the security system. Doing so could affect the proper operation of the system.**
- **Changes or modifications not expressly approved by the party responsible for compliance could void the user's authority to operate the equipment.**

Your vehicle has either or both of the following security systems:

- Theft warning (if equipped)
- NISSAN Anti-theft System (NATS)*
(* immobilizer)

THEFT WARNING SYSTEM (if equipped)

Depending on the model, this vehicle may be equipped with an alarm. It is designed to protect the doors, back door and, depending on the model of the vehicle, the hood against forced entry.

Activation

To activate the alarm, all the opening elements (front and rear doors, hood and back door) must be closed.

The alarm activates only when the opening elements are locked (doors, hood and back door) using the remote controller or the request switch (if equipped). The front and rear doors, hood and back door are monitored as soon as the alarm is activated.

The alarm will not be activated if any of the opening elements (doors, hood or back door) are open.

Deactivation

The alarm deactivates only when the opening elements are unlocked (doors, hood and back door) using the remote controller or the request switch (if equipped). The opening elements are not monitored.

To deactivate the alarm using the mechanical key, you will need to enter the vehicle and place the ignition switch in the "ON" position. (See "Ignition switch (model without Intelligent Key system)" (P.5-6) or "Push-button ignition switch (model with Intelligent Key system)" (P.5-7).)

Triggering the alarm

If the alarm is activated and someone tries to steal the car, the alarm will be triggered.

One triggering sequence lasts for 30 seconds, with the horn sounding and the hazard indicator flasher switched on.

If a door is still opened after the first triggering sequence, the second triggering sequence will be activated for 30 seconds again after several seconds.

After the second triggering sequence is stopped, the alarm will then be switched off.

In the event of forced entry to the vehicle thorough the windows, the alarm will not be triggered as there is no presence sensor.

Radio frequency remote control unit fault

If the key battery runs out, or if the key is damaged, with the alarm activated, simply open the vehicle using the coded key and turn on the ignition switch. The alarm will go off, but will be deactivated once the original vehicle key is recognized in the ignition switch.



WARNING:

Electrical equipment and electronic accessories

- **Work on the vehicle electrical circuits must be carried out by a NISSAN dealer. An incorrectly connected system may result in damage to the electrical and/or the components connected to it.**
- **If the vehicle is fitted with any after-market electrical equipment, make sure that the installation is correctly protected by a fuse. Establish the rating and position of this fuse.**

NISSAN ANTI-THEFT SYSTEM (NATS)

The NISSAN Anti-Theft System (NATS) will not allow the engine to start without the use of the registered NATS key.

If the engine does not start using the registered NATS key, it may be due to interference caused by:

- Another NATS key.
- Automated toll road device.
- Automated payment device.
- Other devices that transmit similar signals.

Start the engine using the following procedure:

1. Remove any items that may be causing the interference away from the NATS key.
2. Leave the ignition switch in the "ON" position for approximately 5 seconds.
3. Place the ignition switch in the "OFF" or "LOCK" position, and wait approximately 10 seconds.
4. Repeat steps 2 and 3 again.

HOOD

5. Start the engine.
6. Repeat the steps above until all possible interferences are eliminated.

If this procedure allows the engine to start, NISSAN recommends placing the registered NATS key separate from other devices to avoid interference.



WARNING:

- **The hood must be closed and latched securely before driving. Failure to do so could cause the hood to fly open and result in an accident.**
- **Never open the hood if steam or smoke is coming from the engine compartment to avoid injury.**

OPENING HOOD

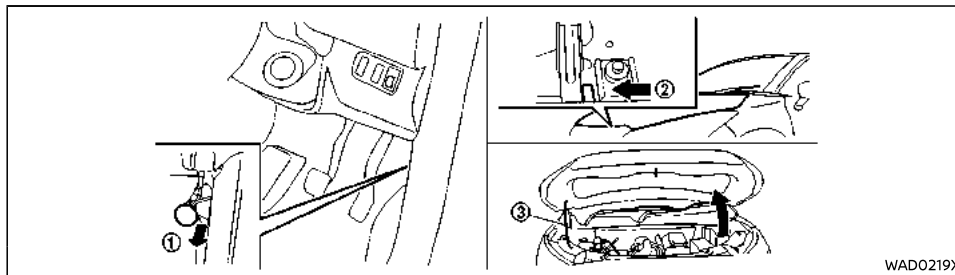

1. Pull the hood lock release handle ① located below the instrument panel until the hood springs up.
2. Locate the lever ② in between the hood and grille and push the lever sideways with your fingertips.
3. Raise the hood.
4. Remove the support rod ③ and insert it into the slot.

Hold the coated parts when removing or resetting the support rod. Avoid direct contact with the metal parts, as they may be hot immediately after the engine has been stopped.

CLOSING HOOD

1. While supporting the hood, return the support rod to its original position.
2. Slowly lower the hood to about 20 to 30 cm (8 to 12 in) above the hood lock, then let it drop.
3. Make sure it is securely latched.

BACK DOOR



WARNING:

- Make sure the back door has been closed securely to prevent it from opening while driving.
- Do not drive with the back door open. This could allow dangerous exhaust gases to be drawn into the vehicle.



CAUTION:

- Before opening the back door, be sure to clear away snow, ice or dust that may be stuck to the back door. If the back door is opened while materials are still stuck to it, it may suddenly close again due to the weight of these materials.
- Always be sure to fully open the back door. If it is not fully opened, it may suddenly shut.
- Be especially careful when opening the back door in strong wind. The door could be caught by a gust of wind and may close suddenly.

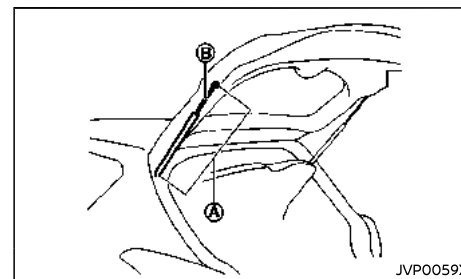

CAUTION:

- The back door gas stays (A) are installed in order to support the weight of the back door. In order to prevent the gas stays being damaged or not operating properly, be sure to observe the following points.
 - Do not insert hands or cords into the gas stays (A) or apply any force to them laterally.
 - Do not attach any adhesive foreign materials such as pieces of plastic or stickers to the rod (B) portion.
- Do not close the back door while holding the gas stays or hang anything on them. Doing so may lead to hands or arms becoming trapped in the back door and could result in an injury.

OPENING BACK DOOR

Models with inside back door opener switch

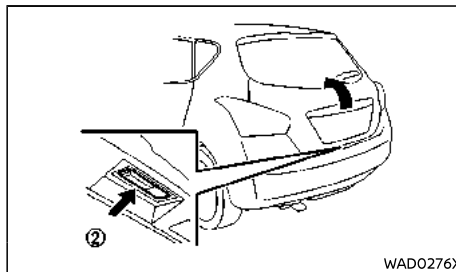
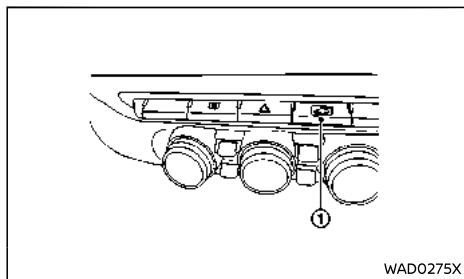

To open the back door, push the inside back door opener switch (1) on the instrument panel, then push the back door opener switch (2) on the back door.

Models without inside back door opener switch

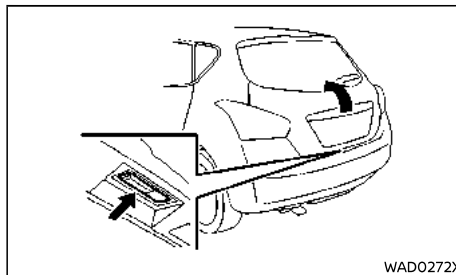

To open the back door, push the back door opener switch with the doors are unlocked. (See "Locking and unlocking with power door lock switch" (P.3-4), "Using remote keyless entry system" (P.3-5) or "Using Intelligent Key system" (P.3-7) depending on your vehicle's equipment.)

CLOSING BACK DOOR

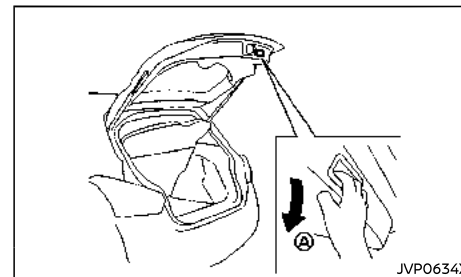

WARNING:

- Do not shut the back door with one hand and the other hand remaining on the back door or vehicle body. Doing so may lead to your hand becoming trapped and could result in an injury.
- When closing the back door, do not place your hands near the edge of the back door. Always be sure to close the back door from the outside.
- After closing the back door, be sure to check that it has been closed securely. If the back door opens while the vehicle is being driven, this could result in a serious accident.

To close the back door, hold the grip (A) to pull down the back door and then push it down securely.

FUEL-FILLER LID

WARNING:

- Fuel is extremely flammable and highly explosive under certain conditions. You could be burned or seriously injured if it is misused or mishandled. Always stop the engine and do not smoke or allow open flames or sparks near the vehicle when refueling.
- Fuel may be under pressure. Turn the cap a half of a turn, and wait for any "hissing" sound to stop to prevent fuel from spraying out and possibly causing personal injury. Then remove the cap.
- Do not attempt to fill the fuel tank more than twice after the fuel pump nozzle shuts off automatically. Continued refueling may cause fuel overflow, resulting in fuel spray and possible a fire.
- Use only an original equipment type fuel-filler cap as a replacement. It has a built-in safety valve needed for proper operation of the fuel system and emission control system. An incorrect cap can result in a serious malfunction and possible injury.

OPENING FUEL-FILLER LID

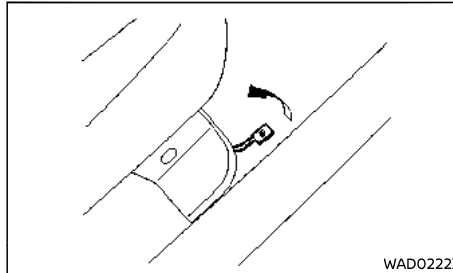

To open the fuel-filler lid, pull the fuel-filler lid opener lever.

FUEL-FILLER CAP

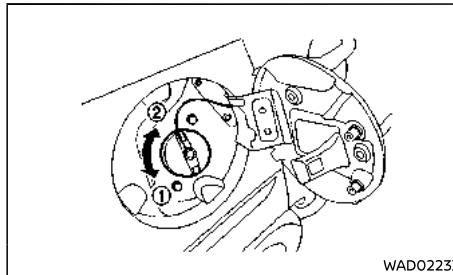

The fuel-filler cap is a ratcheting type. Turn the fuel-filler cap counterclockwise ① to remove. Tighten the fuel-filler cap clockwise ② until ratchet clicks, more than twice, after refueling.

CAUTION:

If fuel is spilled on the vehicle body, flush it away with water to avoid paint damage.

STEERING WHEEL

WARNING:

Never adjust the steering wheel while driving so that full attention may be given to vehicle operation.

TILT OPERATION

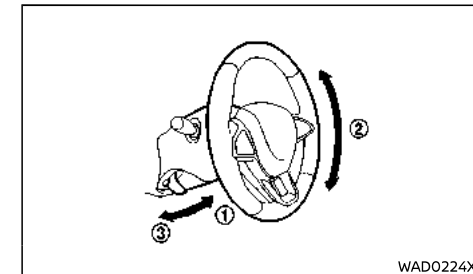

While pulling the lock lever down ③, adjust the steering wheel up or down ② until the desired position is achieved.

Push the lock lever up ① firmly to lock the steering wheel in place.

MIRRORS



WARNING:

Adjust the position of all mirrors before driving. Do not adjust the mirror positions while driving so that full attention may be given to vehicle operation.

INSIDE REARVIEW MIRROR

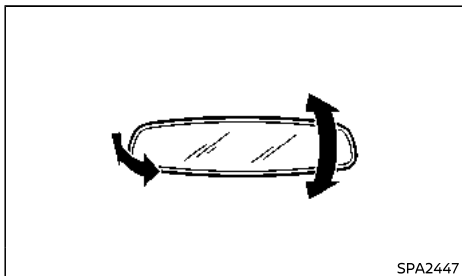

SPA2447

While holding the inside rearview mirror, adjust the mirror angles until the desired position is achieved.

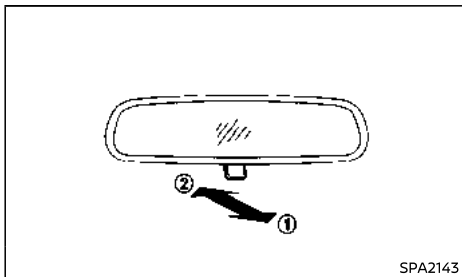

SPA2143

Pull the adjusting lever ① when the glare from the headlights of the vehicle behind you obstructs your vision at night.

Push the adjusting lever ② during the day for the best rearward visibility.

OUTSIDE REARVIEW MIRRORS



WARNING:

- Never touch the outside rearview mirrors while they are in motion. Doing so may pinch your fingers or damage the mirror.
- Never drive the vehicle with the outside rearview mirrors folded. This reduces rear view visibility and may lead to an accident.
- Objects viewed in the outside mirror are closer than they appear (if equipped).
- The picture dimensions and distance in the outside mirrors are not real.

Adjusting

Remote control type (if equipped):

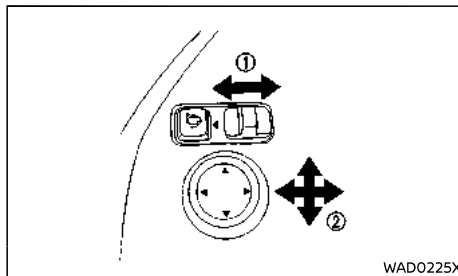

WAD0225X

The outside rearview mirror remote control, located on the driver's door armrest, can be operated when the ignition switch is in the "ON" or "ACC" position.

1. Move the switch to select the right or left mirror ①.
2. Adjust each mirror until the desired position is achieved ②.

Manual control type (if equipped):

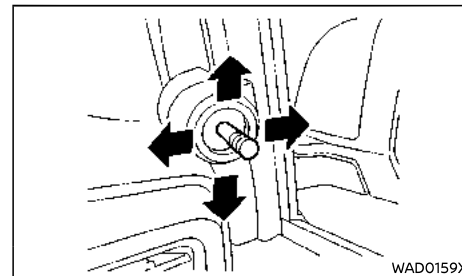

WAD0159X

Example

Adjust the mirror angles with the inside lever until the desired position is achieved.

Folding

Remote control type (if equipped):

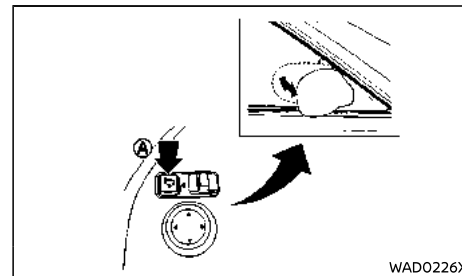

WAD0226X

The outside rearview mirror remote control operates when the ignition switch is in the "ON" or "ACC" position.

The outside rearview mirrors automatically fold when the outside rearview mirror folding switch **A** is pushed. To unfold, push the switch **A** again.

CAUTION:

- Continuously performing the fold/unfold operation of the outside rearview mirror may cause the switch to stop the operation.
- Do not touch the mirrors while they are moving. Your hand may be pinched, and the mirror may malfunction.
- Do not drive with the mirrors stored. You will be unable to see behind the vehicle.
- If the mirrors were folded or unfolded by hand, there is a chance that the mirror will move forward or backward during driving. If the mirrors were folded or unfolded by hand, be sure to adjust them again electrically before driving.

Manual control type (if equipped):

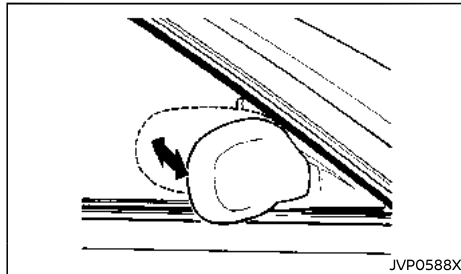

Fold the outside rearview mirror by pushing it toward the rear of the vehicle.

Unfold the outside rearview mirror by pushing

it towards the front of the vehicle.

VANITY MIRROR

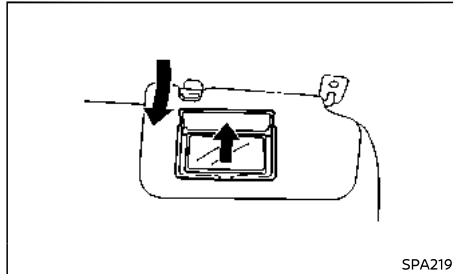

To use the front vanity mirror, pull down the sun visor and pull up the cover.

PARKING BRAKE

WARNING:

- Never drive the vehicle with the parking brake applied. The brake will overheat and fail to operate and will lead to an accident.
- Never release the parking brake from outside the vehicle. If the vehicle moves, it will be impossible to push the foot brake pedal and will lead to an accident.
- Never use the shift lever in place of the parking brake. When parking, be sure the parking brake is fully applied.
- To help avoid risk of injury or death through unintended operation of the vehicle and/or its systems, do not leave children, people who require the assistance of others or pets unattended in your vehicle. Additionally, the temperature inside a closed vehicle on a warm day can quickly become high enough to cause a significant risk of injury or death to people and pets.

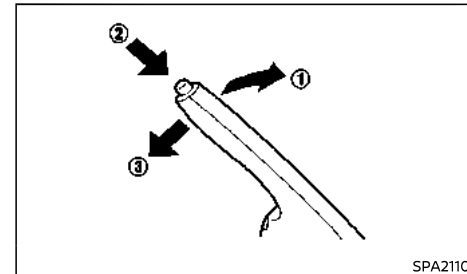

To apply the parking brake, pull the parking brake lever up **1**.

To release the parking brake, firmly depress

and hold the foot brake pedal. Pull up the parking brake lever slightly, push the button ② and lower the lever completely ③.

Before driving, be sure that the brake warning light has turned off.

4 Monitor, heater and air conditioner, and audio system

Safety precautions	4-2	Side ventilators	4-13
Rear view monitor (if equipped)	4-2	Rear ventilators (if equipped)	4-14
Rear view monitor system operation	4-3	Heater and air conditioner	4-14
How to read the displayed lines	4-3	Operating tips (for automatic air conditioner)	4-14
Difference between predictive and actual distances	4-3	Manual air conditioner	4-15
Rear view monitor settings	4-5	Automatic air conditioner	4-17
Rear view monitor system limitations	4-5	Servicing air conditioner	4-18
System maintenance	4-6	Audio system (if equipped)	4-19
Around View Monitor (if equipped)	4-7	Audio operation precautions	4-19
Around View Monitor system operation	4-8	FM-AM radio with USB connection port	4-20
Difference between predictive and actual distances	4-9	Multimedia system (if equipped)	4-31
How to switch the display	4-11	General Information	4-31
Around View Monitor display settings	4-11	User precautions	4-31
Around View Monitor system limitations	4-12	Basic operation	4-31
System maintenance	4-13	Available functions	4-34
Ventilators	4-13	Car phone or CB radio	4-36
Center ventilators	4-13	Antenna	4-37



SAFETY PRECAUTIONS

WARNING:

- Do not adjust the heater and air conditioner controls or audio controls while driving so that full attention may be given to vehicle operation.
- If you noticed any foreign objects entering the system hardware, spilled liquid on the system, or noticed smoke or fumes coming out from the system, or any other unusual operation is observed, stop using the system immediately and contact the nearest NISSAN dealer. Ignoring such conditions may lead to an accident, fire or electric shock.
- Do not disassemble or modify this system. If you do, it may lead to an accident, fire, or electric shock.

CAUTION:

Do not use the system when the engine is not running for extended periods of time to prevent battery discharge.

REAR VIEW MONITOR (if equipped)

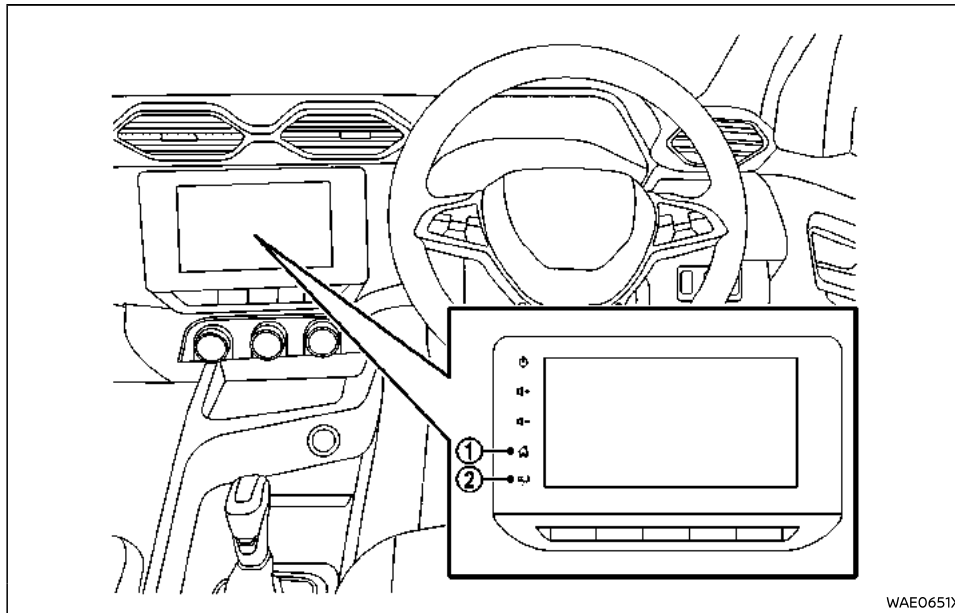

1. Home menu "🏠" button
2. Camera "CAMERA" button

WARNING:

Failure to follow the warnings and instructions for proper use of the rear view monitor could result in serious injury or death.

- The rear view monitor is a convenience but it is not a substitute for proper backing. Always turn and look out the windows, and check mirrors to be sure

that it is safe to move before operating the vehicle. Always back up slowly.

- The system is designed as an aid to the driver in showing large stationary objects directly behind the vehicle, to help avoid damaging the vehicle.
- The distance guide lines and the vehicle width lines should be used as a reference only when the vehicle is on a level paved surface. The distance viewed on the monitor is for reference only and may be different than the actual distance

between the vehicle and displayed objects.

⚠ CAUTION:

Do not scratch the camera lens when cleaning dirt or snow from the front of the camera.

The rear view monitor shows the rear view of the vehicle on the screen to help the driver see the obstacles behind the vehicle.

The radio can still be heard while the rear view monitor is active.

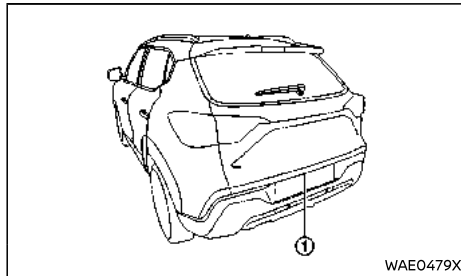

To display the rear view, the rear view monitor system uses a camera ① located just above the vehicle's license plate.

REAR VIEW MONITOR SYSTEM OPERATION

With the ignition switch in the "ON" position, move the shift lever to the "R" (Reverse) position or touch the "CAMERA" button to operate the rear view monitor.

HOW TO READ THE DISPLAYED LINES

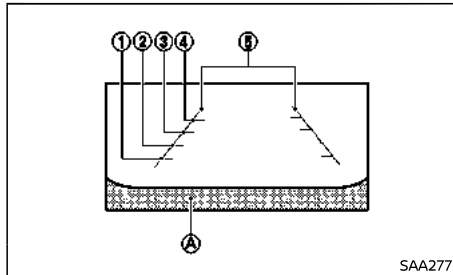

Guiding lines which indicate the vehicle width and distances to objects with reference to the bumper line ⑥ are displayed on the monitor.

Distance guide lines:

Indicate distances from the vehicle body.

- Red line ①: approximately 0.5 m (1.5 ft)
- Yellow line ②: approximately 1 m (3 ft)
- Green line ③: approximately 2 m (7 ft)
- Green line ④: approximately 3 m (10 ft)

Vehicle width guide lines ⑤:

Indicate the vehicle width when backing up.

The vehicle width guide lines are wider than the actual width.

DIFFERENCE BETWEEN PREDICTIVE AND ACTUAL DISTANCES

The displayed guide lines and their locations on the ground are for approximate reference only. Objects on uphill or downhill surfaces or projecting objects will be actually located at distances different from those displayed in the monitor relative to the guide lines (refer to illustrations). When in doubt, turn around and view the objects as you are backing up, or park and exit the vehicle to view the positioning of objects behind the vehicle.

Backing up on a steep uphill

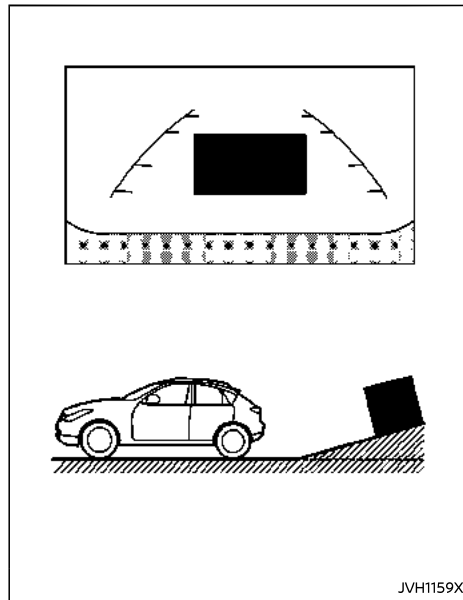

When backing up the vehicle up a hill, the distance guide lines and the vehicle width guide lines are shown closer than the actual distance. Note that any object on steep uphill is farther than it appears on the monitor.

Backing up on a steep downhill

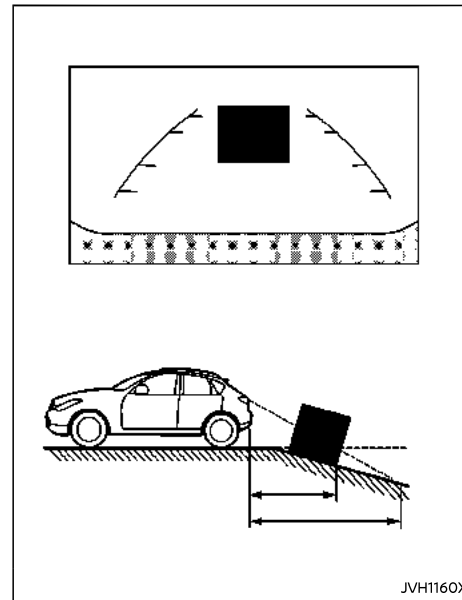

When backing up the vehicle down a hill, the distance guide lines and the vehicle width guide lines are shown farther than the actual distance. Note that any object on steep downhill is closer than it appears on the monitor.

Backing up near a projecting object

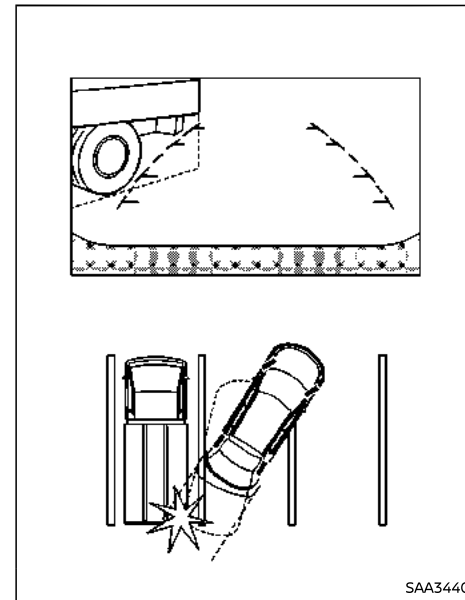

The vehicle may seem to nearly clear the object in the display. However, the vehicle may hit the object if it projects over the actual backing up course.

Backing up behind a projecting object

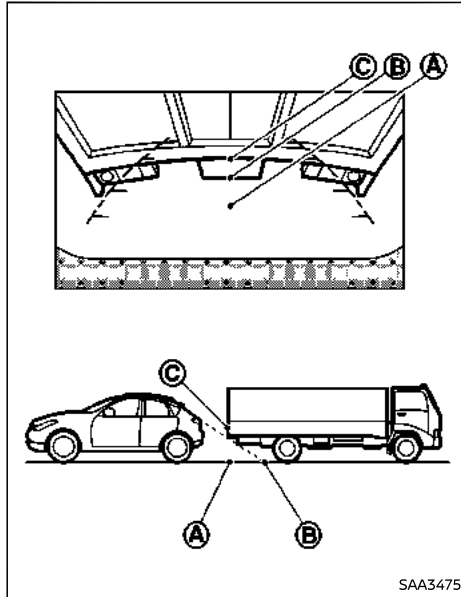

The position © is shown farther than the position ʘ in the display. However, the position © is actually at the same distance as the position ʘ. The vehicle may hit the object when backing up to the position ʘ if the object projects over the actual backing up course.

REAR VIEW MONITOR SETTINGS

Turning rear view monitor on/off

The rear view monitor activation setting can be turned on/off.

1. Touch the "Home" button.
2. Touch the "Vehicle Settings" key and then touch the "Vehicle Settings" key.
3. Touch the "Rear view camera" key to turn the rear view monitor system on/off.

Display settings

Touch the "Settings" key on the rear view monitor screen to change the rear view monitor display settings.

Available items:

Setting item	Action
	The guide lines can be turned on/off.
	Screen color can be changed.
	Screen brightness can be changed.
	Screen contrast can be changed.

REAR VIEW MONITOR SYSTEM LIMITATIONS



WARNING:

Listed below are the system limitations for the rear view monitor. Failure to operate the vehicle in accordance with these system limitations could result in serious injury or death.

- The system cannot completely eliminate blind spots and may not show every object.
- Underneath the bumper and the corner areas of the bumper cannot be viewed on the rear view monitor because of its monitoring range limitation. The system will not show small objects below the bumper, and may not show objects close to the bumper or on the ground.
- Objects viewed in the rear view monitor differ from actual distance because a wide-angle lens is used.
- Objects in the rear view of the vehicle will appear visually opposite compared to when viewed in the inside rearview mirror, the outside rearview mirrors and the rear view monitor.
- Use the displayed lines as a reference. The lines are highly affected by the number of occupants, fuel level, vehicle position, road conditions and road grade.
- Make sure that the back door is securely closed when backing up.
- Do not put anything on the rear view camera. The rear view camera is installed above the license plate.
- When washing the vehicle with high-pressure water, be sure not to spray it around the camera. Otherwise, water may enter the camera unit causing water condensation on the lens, a malfunction, fire or an electric shock.
- Do not strike the camera. It is a precision instrument. Otherwise, it may malfunction or cause damage resulting in a fire or an electric shock.

The following are operating limitations and do

not represent a system malfunction:

- When the temperature is extremely high or low, the screen may not clearly display objects.
- When strong light directly shines on the camera, objects may not be displayed clearly.
- Vertical lines may be seen in objects on the screen. This is due to strong reflected light from the bumper.
- The screen may flicker under fluorescent light.
- The colors of objects on the rear view monitor may differ somewhat from the actual color of objects.
- Objects on the monitor may not be clear in a dark environment.
- There may be a delay when switching to the rear view monitor.
- If dirt, rain or snow accumulates on the camera, the rear view monitor may not display object clearly. Clean the camera.
- Do not use wax on the camera lens. Wipe off any wax with a clean cloth dampened with a diluted mild cleaning agent, then wipe with a dry cloth.

SYSTEM MAINTENANCE

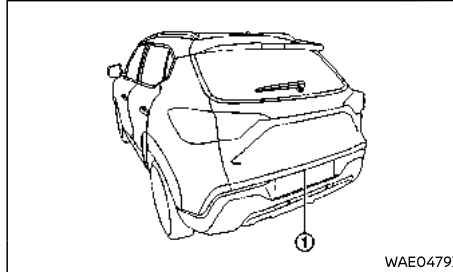

CAUTION:

- **Do not use alcohol, benzine or thinner to clean the camera. This will cause discoloration.**
- **Do not damage the camera as the monitor screen may be adversely affected.**

If dirt, rain or snow accumulates on the camera ①, the rear view monitor may not display objects clearly. Clean the camera by wiping it with a cloth dampened with a diluted mild cleaning agent and then wiping it with a dry cloth.

AROUND VIEW MONITOR (if equipped)

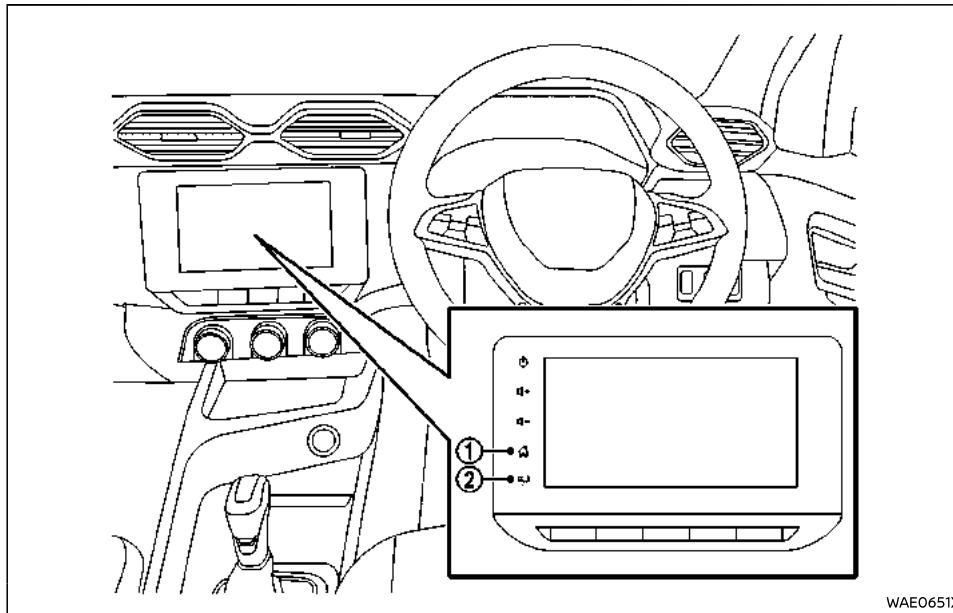

1. Home menu "Home" button
2. Camera "CAMERA" button

WARNING:

Failure to follow the warnings and instructions for the proper use of the Around View Monitor system could result in serious injury or death.

- The Around View Monitor is a convenient feature but it is not a substitute for proper vehicle operation because it has

areas where objects cannot be viewed. The four corners of the vehicle in particular, are areas where objects do not always appear in the bird's-eye, front, or rear views. Always check your surroundings to be sure that it is safe to move before operating the vehicle. Always operate the vehicle slowly. Always look out the windows and check mirrors to be sure that it is safe to move.

- The driver is always responsible for safety during parking and other maneuvers.

CAUTION:

Do not scratch the lens when cleaning dirt or snow from the front of the camera.

The Around View Monitor system is designed as an aid to the driver in situations such as slot parking or parallel parking.

The monitor displays various views of the position of the vehicle in a split screen format. Not all views are available at all times.

Available views:

- Front view
The view to the front of the vehicle.
- Rear view
The view to the rear of the vehicle.
- Bird's-eye view
The surrounding view of the vehicle from above.
- Front-side view
The view around and ahead of the front passenger's side wheel.

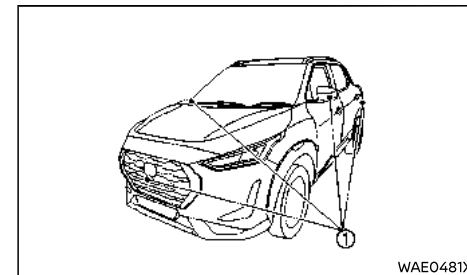

To display the multiple views, the Around View Monitor system uses cameras ① located in the front grill, on the vehicle's outside mirrors and one just above the vehicle's license plate.

AROUND VIEW MONITOR SYSTEM OPERATION

With the ignition switch in the "ON" position, move the shift lever to the "R" (Reverse) position or touch the "CAMERA" button to operate the Around View Monitor.

When the camera is first activated with the bird's-eye view in the display, a red icon will flash on the bird's-eye view screen.

The Around View Monitor screen will automatically return to the previous screen in 3 minutes after the "CAMERA" button has been touched with the shift lever in a position other than the "R" (Reverse) position.

Available views



WARNING:

- The distance guide lines and the vehicle width guide line should be used as a reference only when the vehicle is on a paved, level surface. The distance viewed on the monitor is for reference only and may be different than the actual distance between the vehicle and displayed objects.
- Use the displayed lines and the bird's-eye view as a reference. The lines and the bird's-eye view are greatly affected by the number of occupants, fuel level, vehicle position, road condition and road grade.

- If the tires are replaced with different sized tires, the bird's-eye view may be displayed incorrectly.
- When driving the vehicle up a hill, objects viewed in the monitor are further than they appear. When driving down a hill, objects viewed in the monitor are closer than they appear.
- Objects in the rear view of the vehicle will appear visually opposite compared to when viewed in the inside rearview mirror, the outside rearview mirrors and the Around View Monitor.
- Use the mirrors or actually look to properly judge distances to other objects.
- The vehicle width guide lines are wider than the actual width.

Front and rear view:

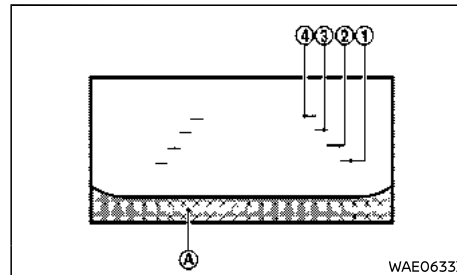

Front view

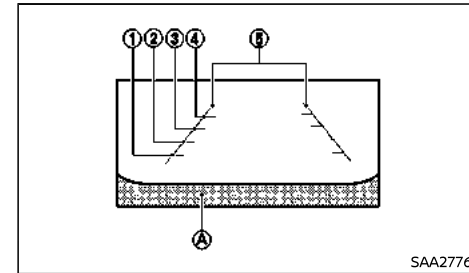

Rear view

Guiding lines that indicate the approximate vehicle width and distances to objects with reference to the vehicle body line A, are displayed on the monitor.

Distance guide lines:

Indicate distances from the vehicle body.

- Red line ①: approximately 0.5 m (1.5 ft)
- Yellow line ②: approximately 1 m (3 ft)
- Green line ③: approximately 2 m (7 ft)
- Green line ④: approximately 3 m (10 ft)

Vehicle width guide lines ⑤:

Indicate the vehicle width when backing up.

The vehicle width guide lines are wider than the actual width.

The Around View Monitor screen will not be displayed when the vehicle speed is above 10 km/h (6 MPH).

Bird's-eye view:

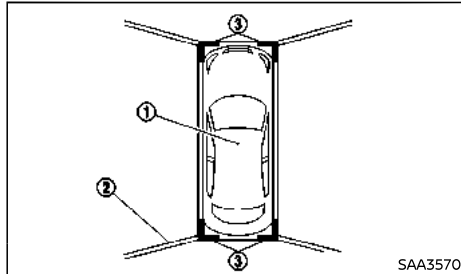

The bird's-eye view shows the overhead view of the vehicle which helps confirm the vehicle position.

The vehicle icon ① shows the position of the vehicle. Note that the distance between objects viewed in the bird's-eye view may differ somewhat from the actual distance to the vehicle.

The areas that the cameras cannot cover ② are indicated in black.

The non-viewable area ② is highlighted in yellow for several seconds after the bird's-eye view is displayed. It will be shown only the first time after the ignition switch is placed in the "ON" position.

After the ignition switch is placed in the "ON" position, the non-viewable corners ③ will be displayed in red (blink for the first few seconds) to remind the driver to be cautious.



WARNING:

- **Objects in the bird's-eye view will appear further than the actual distance.**
- **Tall objects, such as a curb or vehicle, may be misaligned or not displayed at**

the seam of the views.

- **Objects that are above the camera cannot be displayed.**
- **The view for the bird's-eye view may be misaligned when the camera position alters.**
- **A line on the ground may be misaligned and is not seen as being straight at the seam of the views. The misalignment will increase as the line proceeds away from the vehicle.**

Front-side view:

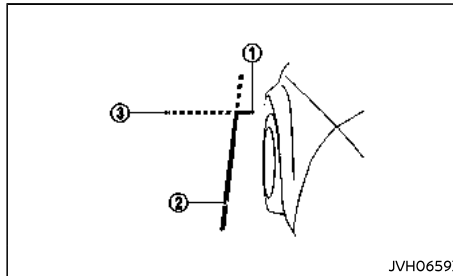

Guiding lines:

Guiding lines that indicate the approximate width and the front end of the vehicle are displayed on the monitor.

The front-of-vehicle line ① shows the front part of the vehicle.

The side-of-vehicle line ② shows the approximate vehicle width including the outside mirrors.

The extensions ③ of both the front ① and side ② lines are shown with a green dotted line.

DIFFERENCE BETWEEN PREDICTIVE AND ACTUAL DISTANCES

The displayed guide lines and their locations on the ground are for approximate reference only. Objects on uphill or downhill surfaces or projecting objects will be actually located at distances different from those displayed in the monitor relative to the guide lines (refer to illustrations). When in doubt, turn around and view the objects as you are backing up, or park and exit the vehicle to view the positioning of objects behind the vehicle.

Backing up on a steep uphill

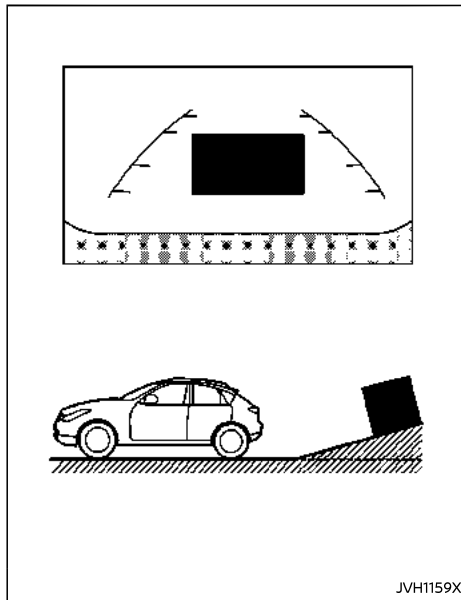

When backing up the vehicle up a hill, the distance guide lines and the vehicle width guide lines are shown closer than the actual distance. Note that any object on steep uphill is farther than it appears on the monitor.

Backing up on a steep downhill

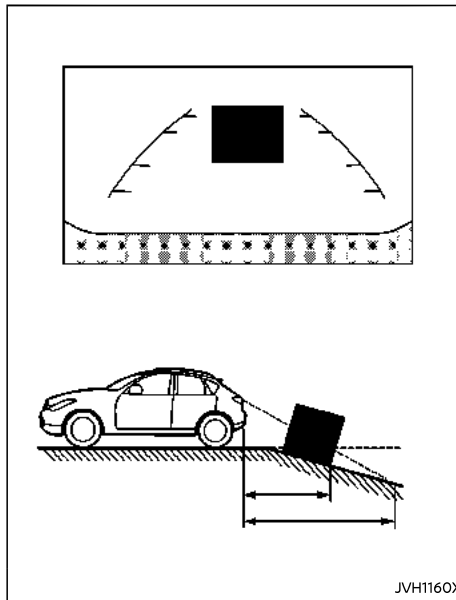

When backing up the vehicle down a hill, the distance guide lines and the vehicle width guide lines are shown farther than the actual distance. Note that any object on steep downhill is closer than it appears on the monitor.

Backing up near a projecting object

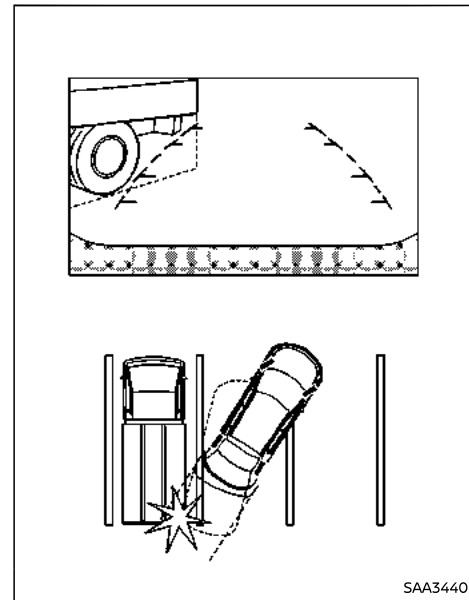

The vehicle may seem to nearly clear the object in the display. However, the vehicle may hit the object if it projects over the actual backing up course.

Backing up behind a projecting object

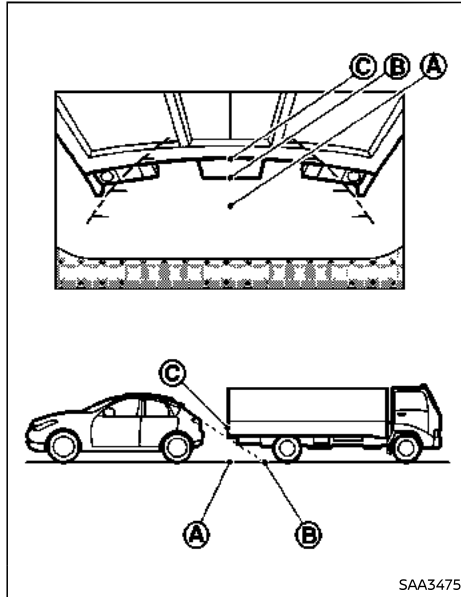

The position © is shown farther than the position © in the display. However, the position © is actually at the same distance as the position ©. The vehicle may hit the object when backing up to the position © if the object projects over the actual backing up course.

HOW TO SWITCH THE DISPLAY

With the ignition switch in the "ON" position, touch the "CAMERA" button or move the shift lever to the "R" (Reverse) position to operate the Around View Monitor.

The Around View Monitor displays different split screen views depending on the position of the shift lever. Touch the "CAMERA" button to switch between the available views.

If the shift lever is in the "R" (Reverse) position, the available views are:

- Bird's-eye view split screen/rear view
- Front-side view split screen/rear view

If the shift lever is not in the "R" (Reverse) position, the available views are:

- Bird's-eye view split screen/front view
- Front-side view split screen/front view

The display will switch from the Around View Monitor screen when:

- The shift lever is out of the "R" (Reverse) position and the vehicle speed increases above approximately 10 km/h (6 MPH).
- A different screen is selected (when the shift lever is not in the "R" (Reverse) position).

AROUND VIEW MONITOR DISPLAY SETTINGS

Touch the "Settings" key on the Around View Monitor screen to change the Around View Monitor display settings.

Available items:

Setting item	Action
	Screen color can be changed.
	Screen brightness can be changed.
	Screen contrast can be changed.

The Around View Monitor display setting screen can also be accessed with the following procedure.

1. Touch the "Home" button.
2. Touch the "Settings" key on the screen and then touch the "Display" key.
3. Touch the "Around View Monitor" key and then touch the "Settings" key.

NOTE:

Do not adjust any of the display settings of the Around View Monitor while the vehicle is moving. Make sure the parking brake is firmly applied.

AROUND VIEW MONITOR SYSTEM LIMITATIONS

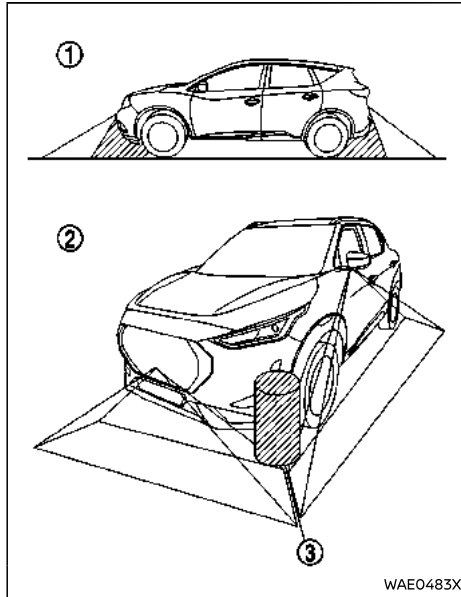

WARNING:

Listed below are the system limitations for Around View Monitor. Failure to operate the vehicle in accordance with these system limitations could result in serious injury or death.

- Do not use the Around View Monitor with the outside mirrors in the stored position, and make sure that the back door is

securely closed when operating the vehicle using the Around View Monitor.

- The apparent distance between objects viewed on the Around View Monitor differs from the actual distance.
- The cameras are installed on the front grille, the outside mirrors and above the rear license plate. Do not put anything on the vehicle that covers the cameras.
- When washing the vehicle with high pressure water, be sure not to spray it around the cameras. Otherwise, water may enter the camera unit causing water condensation on the lens, a malfunction, fire or an electric shock.
- Do not strike the cameras. They are precision instruments. Doing so could cause a malfunction or cause damage resulting in a fire or an electric shock.

There are some areas where the system will not show objects. When in the front or rear view display, an object below the bumper or on the ground may not be viewed ①. When in the bird's-eye view, a tall object near the seam ③ of the camera viewing areas will not appear in the monitor ②.

The following are operating limitations and do not represent a system malfunction:

- There may be a delay when switching between views.
- When the temperature is extremely high or low, the screen may not display objects clearly.
- When strong light directly shines on the camera, objects may not be displayed clearly.

- The screen may flicker under fluorescent light.
- The colors of objects on the Around View Monitor may differ somewhat from the actual color of objects.
- Objects on the Around View Monitor may not be clear and the color of the object may differ in a dark environment.
- There may be differences in sharpness between each camera view of the bird's-eye view.
- Do not use wax on the camera lens. Wipe off any wax with a clean cloth that has been dampened with a diluted mild cleaning agent, then wipe with a dry cloth.

System temporarily unavailable

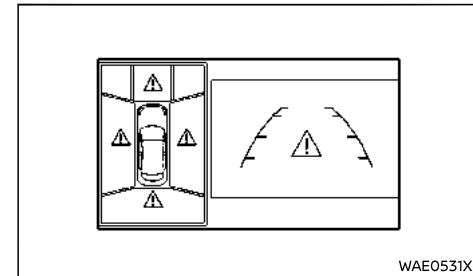

When the "⚠" icon is displayed on the screen, there will be abnormal conditions in the Around View Monitor. This will not hinder normal driving operation but the system should be inspected. It is recommended you visit a NISSAN dealer.

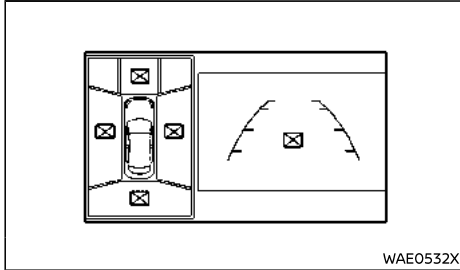

WAE0532X

When the "X" icon is displayed on the screen, the camera image may be receiving temporary electronic disturbances from surrounding devices. This will not hinder normal driving operation but the system should be inspected. It is recommended you visit a NISSAN dealer.

SYSTEM MAINTENANCE

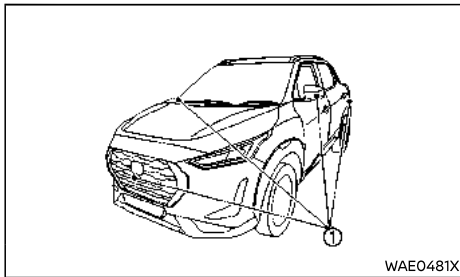

WAE0481X

CAUTION:

- **Do not use alcohol, benzine or thinner to clean the camera. This will cause discoloration.**

- **Do not damage the camera as the monitor screen may be adversely affected.**

If dirt, rain or snow accumulates on any of the cameras ①, the Around View Monitor may not display objects clearly. Clean the camera by wiping with a cloth dampened with a diluted mild cleaning agent and then wiping with a dry cloth.

VENTILATORS

CENTER VENTILATORS

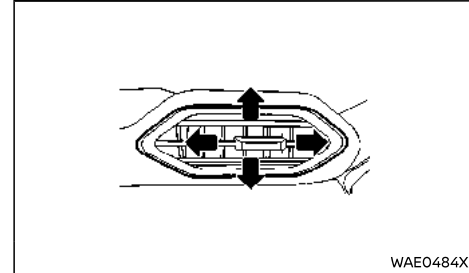

WAE0484X

Adjust the air flow direction of the ventilators by moving the center knob (up/down, left/right) until the preferred position is achieved.

Moving the center knob to its maximum toward the center of the vehicle will close the ventilator.

SIDE VENTILATORS

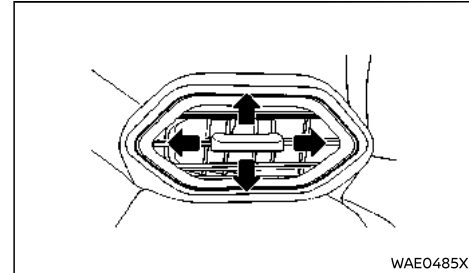

WAE0485X

Adjust the air flow direction of the ventilators by moving the center knob (up/down, left/right) until the preferred position is achieved.

Moving the center knob to its maximum toward the sides of the vehicle will close the

ventilator.

REAR VENTILATORS (if equipped)

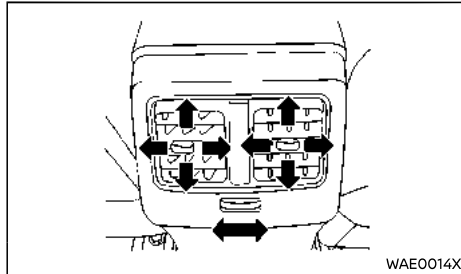

The air blows from the rear ventilators only when the automatic air conditioner is operating in the cooling mode.

Open/close the ventilators by moving the control to either direction.

- ☐ : This symbol indicates that the ventilators are open. Moving the control to this direction will open the ventilators.
- ☒ : This symbol indicates that the ventilators are closed. Moving the control to this direction will close the ventilators.

Adjust the air flow direction of the ventilators by moving the center knob (up/down, left/right) until the desired position is achieved.

HEATER AND AIR CONDITIONER

WARNING:

- The heater and air conditioner operate only when the engine is running.
- Children or adults who would normally require supervision should never be left alone in the vehicle. Pets should not be left alone either. They could unknowingly activate switches or controls and inadvertently become involved in a serious accident and injure themselves. On hot, sunny days, temperatures in a closed vehicle could quickly become high enough to cause severe or possibly fatal injuries to people or animals.
- Do not use the recirculation mode for long periods as it may cause the interior air to become stale and the windows to fog up.
- Do not adjust the heating and air conditioning controls while driving so that full attention may be given to vehicle operation.

The heater and air conditioner operate when the engine is running. The air blower will operate even if the engine is turned off and the ignition switch is in the "ON" position.

NOTE:

- **Odors from inside and outside the vehicle can build up in the air conditioner unit. Odor can enter the passenger compartment through the ventilators.**
- **When parking, set the cooler and air conditioner controls to turn off air recirculation to allow fresh air into the passenger compartment. This should help reduce odors inside the vehicle.**

OPERATING TIPS (for automatic air conditioner)

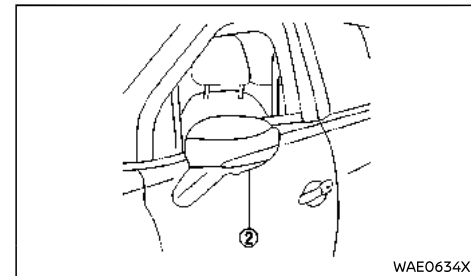
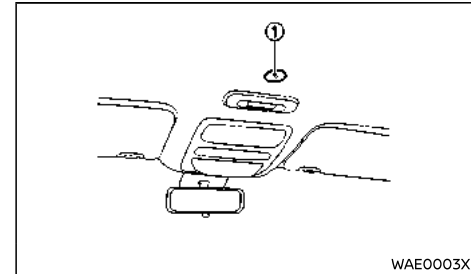

When the engine coolant temperature and outside air temperature are low, the air flow from the foot outlets may not operate. However, this is not a malfunction. After the coolant temperature warms up, the air flow from the foot outlets will operate normally.

The sensors ① and ② help maintain a constant temperature. Do not cover the sensors or put anything on or around the sensors.

MANUAL AIR CONDITIONER

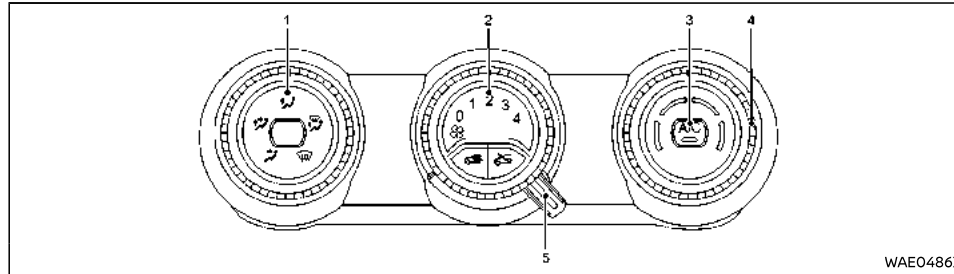

1. Air flow control dial
2. Fan speed control "☼" dial
3. "A/C" button
4. Temperature control dial
5. Air intake lever (outside air circulation "☼" /air recirculation "☼")

To turn off the heater and air conditioner, turn the fan speed control "☼" dial to the "0" (OFF) position.

Controls

Outside air circulation:

Move the air intake lever to the "☼" position. The air flow is drawn from outside the vehicle.

Air recirculation:

Move the air intake lever to the "☼" position. The air flow is circulated inside the vehicle.

Air flow control:

Turn the air flow control dial to change the air flow mode.

- ☼ — Air flows from the center and side ventilators.
- ☼ — Air flows from the center and side ventilators and foot outlets.
- ☼ — Air flows mainly from the foot outlets.
- ☼ — Air flows from the defogger and foot outlets.
- ☼ — Air flows mainly from the defogger outlets.

Fan speed control:

Turn the fan speed control "☼" dial clockwise to increase the fan speed.

Turn the fan speed control "☼" dial counter-clockwise to decrease the fan speed.

Temperature control:

Turn the temperature control dial to set the desired temperature. Turn the dial between the middle and the right position to select the hot temperature. Turn the dial between the middle and the left position to select the cool temperature.

A/C operation:

Push the "A/C" button to turn on or off the air conditioner. When the air conditioner is on, the "A/C" indicator light on the button illuminates.

Heater operation

Heating:

This mode is used to direct heated air to the foot outlets.

1. Move the air intake lever to the "☼" position for normal heating.
2. Turn the air flow control dial to the "☼" position.
3. Turn the fan speed control "☼" dial to the desired position.
4. Turn the temperature control dial to the desired position between the middle and the hot (right) position.

Ventilation:

This mode directs outside air to the side and center ventilators.

1. Move the air intake lever to the "☼" position.
2. Turn the air flow control dial to the "☼" position.
3. Turn the fan speed control "☼" dial to the desired position.

4. Turn the temperature control dial to the desired position.

Defrosting or defogging:

This mode directs the air to the defogger outlets to defrost/defog the windows.

1. Move the air intake lever to the "☞" position.
 2. Turn the air flow control dial to the "☂" position.
 3. Turn the fan speed control "☼" dial to the desired position.
 4. Turn the temperature control dial to the desired position between the middle and the hot (right) position.
- To remove frost from the outside surface of the windshield quickly, turn the temperature control dial to the maximum hot position and the fan speed control "☼" dial to the maximum position.
 - If it is difficult to defog the windshield, turn the "A/C" button on.

Heating and defogging:

This mode heats the interior and defogs the windows.

1. Move the air intake lever to the "☞" position.
2. Turn the air flow control dial to the "☂" position.
3. Turn the fan speed control "☼" dial to the desired position.
4. Turn the temperature control dial to the maximum hot (right) position.
5. Turn the side ventilators to the side windows to defrost or defog for a clear view to the side mirrors.

Air conditioner operation

The air conditioner system should be operated for approximately 10 minutes at least once a month. This helps prevent damage to the air conditioner system due to the lack of lubrication.

Cooling:

This mode is used to cool and dehumidify the air.

1. Move the air intake lever to the "☞" position.
 2. Turn the air flow control dial to the "☂" position.
 3. Turn the fan speed control "☼" dial to the desired position.
 4. Push the "A/C" button on. (The "A/C" indicator light will illuminate.)
 5. Turn the temperature control dial to the desired position between the middle and the cool (left) position.
- For quick cooling when the outside temperature is high, move the air intake lever to the "☞" position. Be sure to move the air intake lever to the "☞" position for normal cooling.
 - A visible mist may be seen coming from the ventilators in hot, humid conditions as the air is cooled rapidly. This does not indicate a malfunction.

Dehumidified heating:

This mode is used to heat and dehumidify the air.

1. Move the air intake lever to the "☞" position.
2. Turn the air flow control dial to the "☂" position.

3. Turn the fan speed control "☼" dial to the desired position.
4. Push the "A/C" button on. (The "A/C" indicator light will illuminate.)
5. Turn the temperature control dial to the desired position between the middle and the hot (right) position.

Dehumidified defogging:

This mode is used to defog the windows and dehumidify the air.

1. Move the air intake lever to the "☞" position.
2. Turn the air flow control dial to the "☂" position.
3. Turn the fan speed control "☼" dial to the desired position.
4. Push the "A/C" button on. (The "A/C" indicator light will illuminate.)
5. Turn the temperature control dial to the desired position.

AUTOMATIC AIR CONDITIONER

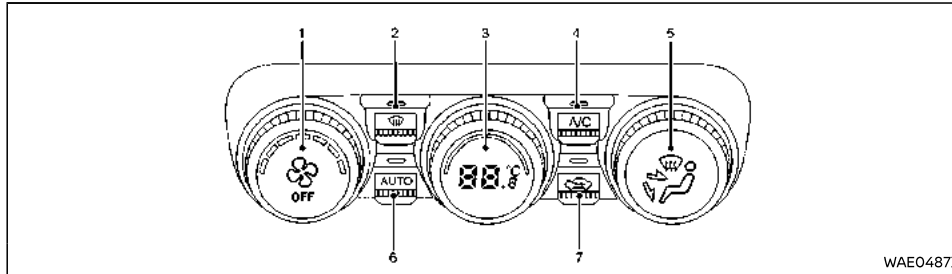

1. Fan speed control "🌀" dial
2. Front defogger "🌫️" button
3. Temperature control dial
4. "A/C" button
5. Air flow control dial
6. "AUTO" button
7. Air intake control "👉" button

Automatic operation (AUTO)

The AUTO mode may be used year-round as the system automatically controls air flow distribution, air circulation mode, A/C on/off, temperature and fan speed.

1. Push the "AUTO" button. (The "AUTO" indicator light will illuminate.)
2. Turn the temperature control dial to set the desired temperature.

A visible mist may be seen coming from the ventilators in hot, humid conditions as the air is cooled rapidly. This does not indicate a malfunction.

Dehumidified defrosting/defogging:

1. Push the front defogger "🌫️" button. (The "🌫️" indicator light will illuminate.)
2. Turn the temperature control dial to set the desired temperature.
 - To quickly remove frost or fog from the outside surface of the windshield, set the temperature using the temperature control dial and set the fan speed using the fan speed control "🌀" dial at its maximum level.
 - After the windshield is cleared, push the front defogger "🌫️" button again.
 - When the front defogger "🌫️" button is pushed, the air conditioner will automatically turn on when the outside air temperature is above -2°C (28°F) to defog the windshield. The outside air circulation mode will be selected to improve the defogging performance.

Manual operation

The manual mode can be used to control the heater and air conditioner to your preferred settings.

Fan speed control:

Turn the fan speed control "🌀" dial clockwise to increase the fan speed.

Turn the fan speed control "🌀" dial counter-clockwise to decrease the fan speed.

Air flow control:

Turn the air flow control dial to change the air flow mode.

- 🌀 — Air flows mainly from the foot outlets.
- 🌀 — Air flows from the center and side ventilators and foot outlets.
- 🌀 — Air flows from the center and side ventilators.
- 🌀 — Air flows from the defogger outlets and foot outlets.
- 🌀 — Air flows mainly from the front defogger outlets.

Push the front defogger "🌫️" button to defrost/defog the windshield.

Temperature control:

Turn the temperature control dial to set the desired temperature.

Air intake control:

The air intake control mode will change each time the air intake control "👉" button is pushed.

- When the indicator light is turned off, the air recirculates inside the vehicle.

- When the indicator light is turned on, the air flow is drawn from outside the vehicle.

Turning the system off:

To turn off the heater and air conditioner, turn the fan speed control "  " dial counterclockwise until the "OFF" indicator light turns on.

SERVICING AIR CONDITIONER



WARNING:

The air conditioner system contains refrigerant under high pressure. To avoid personal injury, any air conditioner service should be done only by an experienced technician with the proper equipment.

The air conditioner system in your vehicle is charged with a refrigerant designed with the environment in mind.

This refrigerant will not harm the earth's ozone layer. However, it may contribute in a small part to global warming.

Special charging equipment and lubricant are required when servicing your vehicle's air conditioner. Using improper refrigerants or lubricants will cause severe damage to the air conditioner system. (See "Air conditioner system refrigerant and lubricant" (P.9-5).)

A NISSAN dealer will be able to service your environmentally friendly air conditioner system.

Air conditioner filter

The air conditioner system is equipped with an air conditioner filter which collects dust. To make sure the air conditioner heats defogs and ventilates efficiently, replace the filter in accordance with the specified maintenance intervals listed in the separate maintenance booklet. To replace the filter, contact a NISSAN dealer.

The filter should be replaced if the air flow decreases significantly or if windows fog up easily when operating the heater or air conditioner.

AUDIO SYSTEM (if equipped)

AUDIO OPERATION PRECAUTIONS



WARNING:

It is essential to follow the precautions below when using the system, both in the interest of safety and to prevent material damage. You must always comply with the laws of the country in which you are travelling.

Precautions when operating the audio system

- Operate the controls (on the instrument panel or the steering wheel) and see the information on the screen only when road conditions allow.
- Set the volume to a reasonable level so that outside noise can be heard.

Precautions concerning the equipment

- Do not attempt to dismantle or modify the system, as there is a risk of damage to equipment and fire.
- Contact a NISSAN dealer in the event of malfunction and for all operations involving disassembly.

Precautions when using the phone

- There are laws which govern the use of phones in vehicles. They do not necessarily authorise the use of hands-free phone systems under all driving conditions: drivers must be in control of their vehicles at all times.
- Using a phone while driving is a significant distraction and risk factor during all stages of use (dialing, communicating, searching for a number in the handset memory, etc.).

Maintenance of the fascia

- Use a soft cloth and, if necessary, a small amount of soapy water. Rinse with a soft, slightly damp cloth, then dry with a soft, dry cloth.
- Do not press on the display on the front panel, and do not use any alcohol-based products.

FM-AM RADIO WITH USB CONNECTION PORT

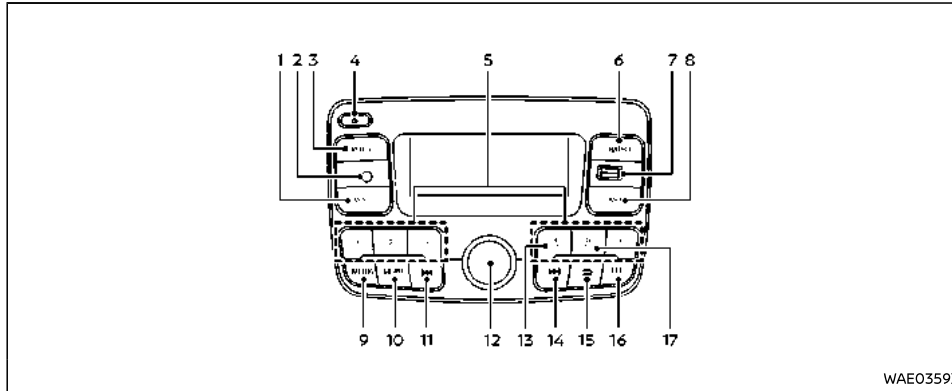

1. VOL – (Volume down) button
2. AUX IN (auxiliary input) jack
3. VOL + (Volume up) button
4. Power button
5. Station memory buttons
6. RADIO button
7. USB connection port
8. AST (Autostore) button
9. MEDIA button
10. MENU button
11. Seek/track (rewind) button
12. MENU dial
13. RDM (Random) button
14. Seek/track (fast forward) button
15. Back button
16. TEL (Phone) button
17. INFO (Information) button

Microphone:

Microphone is located on the ceiling above the driver's seat.

General description

Introduction:

The audio system has the following functions.

- RDS radio
- management of auxiliary audio sources
- Bluetooth® hands-free phone system

Radio functions:

Your audio system allows you to listen to radio.

The radio stations are classed by wavelength: FM (frequency modulation) and AM (amplitude modulation).

The RDS system enables the names of certain stations to be displayed and types of program or information messages broadcast by FM

radio stations to be heard.

- traffic bulletins (TA)
- emergency messages (PTY31)

Auxiliary audio function:

You can listen to your personal stereo directly through your vehicle's speakers. There are several ways of connecting your personal stereo, depending on the type of device you have.

- USB connection port
- Jack socket
- Bluetooth® connection

For more information on compatible devices, please contact a NISSAN dealer.

Hands-free phone function:

The Bluetooth® Hands-Free Phone System provides the following features without having to handle your phone.

- pair up to five phones
- send/receive/reject a call
- transfer the contacts list from the phone memory and the card SIM
- view the call log for calls which have come through the audio system
- call voicemail

Telephone compatibility:

Some phones are not compatible with the hands-free system, and do not enable you to use all of the available functions or do not provide the best possible sound quality.

For more information on compatible phones, contact a NISSAN dealer or visit the manufacturer's website if available.

4-20 Monitor, heater and air conditioner, and audio system



WARNING:

Your hands-free phone system is only intended to facilitate communication by reducing the risk factors, without removing them completely. You must always comply with the laws of the country in which you are travelling.

Bluetooth® function:

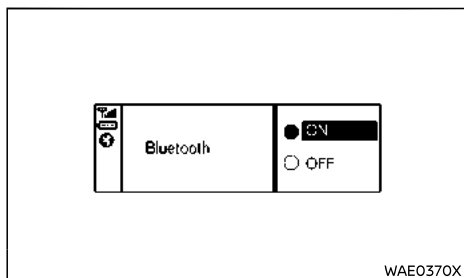

This function enables the audio system to recognize and operate your portable audio player or mobile phone by Bluetooth® pairing. You can activate/deactivate the Bluetooth® function via the "Bluetooth" menu.

- Display the "Phone" menu by pressing ⑯ on the front panel of the audio system.
- Select "Bluetooth" by turning and pressing ⑫ on the front panel of the audio system.
- Select ON/OFF.

Operation

On and off:

Briefly press button ④ on the front panel of the audio system to switch on your system.

The audio system can be used with the ignition switch in the "OFF" position. It will operate for 10 minutes. Press button ④ on the front panel of the audio system to operate the system for a further 10 minutes.

Switch off the audio system by briefly pressing button ④ on the front panel of the audio system.

Choosing the source:

Scroll through the various audio sources by pressing button ⑨ successively on the front panel of the audio system. When scrolling, the sources appear in the following order: iPod → USB → AUX → Bluetooth®.

NOTE:

Press button ⑯ on the front panel of the audio system to display the "Phone" menu.

You may also select the radio source by pressing button ⑥ on the front panel of the audio system.

Repeatedly pressing the button ⑥ on the front panel of the audio system scroll through wavebands in the following order: FM1 → FM2 → AM → FM1.

Volume:

Adjust the volume by pressing the button ① or ③ on the front panel of the audio system.

The display of the audio system reads "VOLU- LUME" followed by the current setting value (from 00 to 31).

Listening to the radio

Selecting a waveband:

Repeatedly push button ⑥ on the front panel of the audio system to choose the desired waveband: FM1 → FM2 → AM → FM1.

Selecting a radio station:

There are different modes for choosing a radio station.

Automatic search

This mode allows stations to be searched by automatically scanning the selected band.

To access the stations, briefly press ⑪ or ⑭ on the front panel of the audio system.

To stop the station search, briefly press button ⑥, ⑪ or ⑭ or one of the keys on the keypad ⑤ on the front panel of the audio system.

Manual search

This mode allows you to search for stations manually by scanning the selected waveband. To access the stations, press and hold the button ⑪ or ⑭ on the front panel of the audio system.

You can release the button ⑪ or ⑭ on the front panel of the audio system to refine the search. Press the button ⑪ or ⑭ on the front panel of the audio system to increase or decrease the frequency by 0.05 Hz (depending on the direction of rotation).

Storage of radio stations:

This operating mode allows you to listen to your pre-set radio stations.

Select a wavelength, then select a radio station using the methods described above.

Store a station by pressing and holding one of the buttons on the keypad ⑤ on the front panel of the audio system. A beep will indicate that

the station has been stored.

You can save up to six stations per waveband.

Recall stored stations by pressing one of the buttons on the keypad ⑤ on the front panel of the audio system.

AST (Autostore) function:

The AST function enables you to save the six stations with the strongest frequencies in your current area.

When listening to the radio, briefly press the button ⑧ on the front panel of the audio system to activate AST mode. The radio returns to the last AST station listened to. Press and hold the button ⑧ on the front panel of the audio system. The automatic frequency scan is triggered to search for the six best stations.

When listening to the radio, press the button ⑩ on the front panel of the audio system then select "Radio Autostore". Press the button ⑫ on the front panel of the audio system and activate AST mode. The automatic frequency scan is triggered to search for the six best stations.

To switch from one saved frequency to another, press one of the buttons on the keypad ⑤ on the front panel of the audio system. The strongest frequency will be saved as P1.

NOTE:

Some buttons may not correspond to a radio station if "Radio Autostore" has found fewer than six stations.

Manual search

In AST mode, you can manually modify the frequencies detected by your audio system.

Press one of the button ⑪ or ⑬ on the front panel of the audio system to adjust the frequency, then press and hold one of the

buttons on the keypad ⑤ to save the selected frequency.

NOTE:

Bands FM1, FM2, AM and AST will let you store a total of 24 stations.

AF-RDS automatic retuning:

The frequency of an FM station changes according to the geographical area. Certain stations use the RDS system which allows automatic retuning. The radio system is able to follow the changes in frequency of these stations.

NOTE:

If the radio station does not provide the RDS frequency function, the message AF flashes on the audio system display.

Poor reception can sometimes cause unwanted changes in frequency. In this case you should deactivate the automatic frequency retuning.

To activate/disable the AF, PTY31, REG, TA functions, display the RDS menu by pressing the button ⑬ on the front panel of the audio system, select "RDS Options", then press the button ⑭ on the front panel of the audio system.

Auxiliary audio sources

Your audio system has an auxiliary input to connect an external audio source (USB device, MP3 player, iPod, Bluetooth® portable audio player, etc.).

There are several ways to connect your portable audio player:

- USB connection port

- AUX IN (auxiliary input) jack
- Bluetooth® connection

NOTE:

- **The auxiliary audio source formats include MP3, WMA and AAC.**
- **The USB device used must be formatted to FAT32 format and have a maximum capacity of 32Gb.**

USB connection port:

Connection

Insert the connector of the iPod or the USB device to the USB connection port on the front panel of the audio system.

Once the device's connector has been connected to the USB connection port, the track being played is displayed automatically.

NOTE:

- **If this is the first time that the device is connected to the audio system, audio playback will start at the first track in the first folder on the source. Otherwise, playback starts from the last track played (if you connect the same device twice).**
- **Once connected, you can no longer directly control your portable digital audio player. You must use the buttons on the front panel of the audio system.**

Use

- iPod:
After connecting your iPod, the menus are accessible from your audio system. The system keeps the same playlists as on your iPod.
- USB device:
Playback of the first audio file from the first folder on your USB device begins automa-

tically.

If you are in the menu tree structure, you can change the track or the folder by turning and pressing the dial ⑫ on the front panel of the audio system. If you are not in the tree structure, rotating the control dial has no effect.

NOTE:

- To access the menu of your device (the iPod or the USB device) while playing an audio track, press ⑮ on the front panel of the audio system.
- With the iPod or the USB device, random play runs on the folder currently being played. Change folder to run random playback on another folder.

Bluetooth® audio playback:

To use your Bluetooth® portable audio player, you must pair it to the vehicle the first time you use it.

Pairing allows the audio system to recognize and store a portable Bluetooth® audio player or a Bluetooth® phone.

NOTE:

If your Bluetooth® digital device has telephone and portable audio player functions, pairing one of these functions will automatically pair the other.

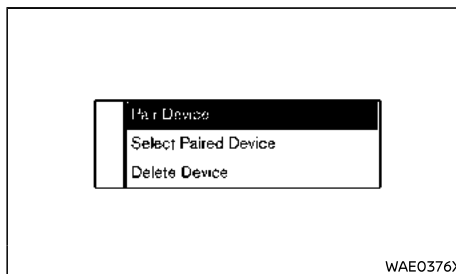

Connection

- Activate the Bluetooth® connection of the portable audio player or phone (refer to the user manual of your portable audio player or phone).
- Activate the Bluetooth® of your audio system by pressing the button ⑮ on the front panel of the audio system. A message on the display of the audio system will confirm the activation of Bluetooth®.
- A four-digit code will appear on the screen of your audio system.
- Select "My Radio" on your player (or phone).
- Enter the four-digit code displayed on the audio system from the keypad of your player (or phone).
- A message confirming pairing will appear on the display on the audio system.
- Select the desired audio source Bluetooth® by pressing ⑨ on the front panel of the audio system, then turn the dial ⑫ on the front panel of the audio system. Confirm the chosen source by pressing ⑫ on the front panel of the audio system.

NOTE:

- If the AUX source is disconnected, the audio system returns to the previous menu.
- According to the make and model of your device, the Bluetooth® function may be partially or totally incompatible with your vehicle's audio system. Please consult a NISSAN dealer.

Use

Your portable audio player must be connected to the audio system to access all its functions.

NOTE:

No portable audio player can be connected to the audio system unless it has previously been paired.

Once the Bluetooth® digital portable audio player is connected, you can control it from your audio system.

Press the button ⑫ on the front panel of the audio system to pause the audio track (pressing again resumes playback).

Depending on the device, press one of the buttons ⑪ or ⑭ on the front panel of the audio system to go to the previous or next track on the portable audio device.

NOTE:

- The number of accessible functions varies depending on the type of portable audio player and its compatibility with the audio system.
- In some cases, refer to the user manual for your device to finalize the connection procedure.

AUX IN (auxiliary input) jack:

Connection

Using the appropriate cable (not provided), connect the AUX IN (auxiliary input) jack of the auxiliary input ② on the front panel of the system to portable audio player headphones plug (usually a 3.5 mm jack).

NOTE:

You cannot select a track directly from your audio system. To select a track, you must do so directly via your portable audio player, when the vehicle is stationary.

Use

Just the text "AUX" appears on the audio system screen. No artist or track name is visible.



WARNING:

Only handle the personal stereo when traffic conditions permit.

Store the portable audio player safely while driving (risk of being thrown in the event of sudden braking or impact).

Pairing, unpairing a phone

Pairing a phone:

In order to use your hands-free phone system, you must pair your Bluetooth® phone with your vehicle when using it for the first time.

Pairing will enable the hands-free phone system to recognize and store a phone.

You can pair up to five phones, but only one can be connected at a time to the hands-free telephone system.

Pairing can be performed from the audio system or your phone.

Your audio system and phone must both be switched on.

NOTE:

If a phone is already connected, during a new pairing procedure, the existing connection will automatically be disconnected.

Pairing a Bluetooth® telephone from the audio system:

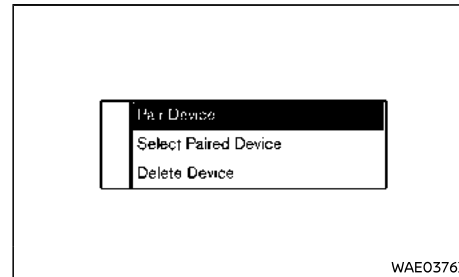

- Activate your phone's Bluetooth® (refer to your phone's user guide).
- Display the "Phone" menu by pressing the button ⑬ on the front panel of the audio system.
- Select "Pair Device" by turning and pressing the dial ⑫ on the front panel of the audio system.
- The "Ready to Pair" will appear on the audio system display.
- From your phone search for Bluetooth® equipment in the vicinity.
- Enter the pairing code displayed on the audio system screen using your telephone's keypad.

Please refer to the telephone's handbook for further information.

Once pairing is completed:

- A message with the name of the telephone that has been paired is displayed.
- The phone is automatically connected to the vehicle.

If pairing fails, the audio system screen returns to the "Phone" menu.

If the list of paired phones is full, a new phone can only be paired if an existing phone is unpaired.

Unpairing a phone:

Unpairing deletes a phone from the hands-free phone system memory.

Display the "Phone" menu by pressing the button ⑬ on the front panel of the audio system, then select the "Delete Device" menu. Select the phone to be unpaired from the list, press ⑫ on the front panel of the audio system, then select "YES".



WARNING:

Your hands-free phone system is only intended to facilitate communication by reducing the risk factors, without removing them completely. You must always comply with the laws of the country in which you are travelling.

Connecting, disconnecting a telephone

Connecting a paired phone:

Your phone must be connected to the hands-free phone system in order to use all its functions.

No phone can be connected to the hands-free phone system unless it has previously been paired. (See "Pairing, unpairing a phone" (P.4-24).)

NOTE:

The Bluetooth® connection on your phone must be activated.

Automatic connection:

Once the ignition switch is placed in the "ON" position, the hands-free phone system searches for nearby paired phones.

NOTE:

The priority phone is the last to have been connected.

Searching will continue until a paired phone is found (this may take up to 5 minutes).

NOTE:

- **You can use automatic telephone connection with the ignition switch in the "ON" position. You may need to activate the automatic Bluetooth® connection function on your hands-free phone system. To do this, refer to the user manual for your phone.**
- **When reconnecting, and when two paired phones are within range of the hands-free system, the last phone to have been connected will take priority, even if this phone is outside the vehicle but within range of the hands-free system.**

NOTE:

If a call is already in progress when your hands-free phone system is connected, the phone will automatically be connected and the conversation will switch to the vehicle speakers.

Manual connection (changing the phone connected):

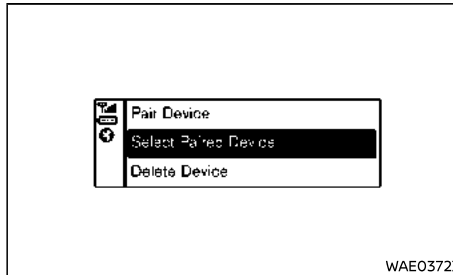

To connect another Bluetooth® device to the audio system:

- Display the settings menu by pressing the button ⑩ on the front panel of the audio system.
- Select the "Select Paired Device" menu using the dial ⑫ on the front panel of the audio system.

You will find the list of phones already paired.

- Select the phone that you want to connect from the list and confirm by pressing the dial ⑫ on the front panel of the audio system.

A message on the audio system display will indicate that the phone is connected.

Connection failure:

If connection fails, check that:

- Your phone is switched on.
- Your telephone battery is not flat.
- Your phone has been previously paired with the audio system.
- The Bluetooth® on your phone and on the audio system are activated.
- The phone is configured to accept all pairing requests.

NOTE:

Using your hands-free phone system for prolonged periods will discharge your phone's battery more quickly.

Disconnecting a phone:

To disconnect your phone from the audio system:

- Display the settings menu by pressing the button ⑩ or ⑬ on the front panel of the audio system.
- Select the "Bluetooth Connection" menu using the dial ⑫ on the front panel of the audio system.
- Select the phone you wish to disconnect from the list, then select "Disconnect" by turning and pressing the dial ⑫ on the front panel of the audio system.

Switching off the phone will also cause it to be disconnected from the audio system.

A message will then appear on the audio system display to confirm that the phone has been disconnected.

NOTE:

If a call is in progress when the phone is disconnected, the call will automatically be transferred to your phone.

To disconnect your phone, you can also:

- Deactivate the Bluetooth® function of your audio system.
- Deactivate Bluetooth® on your phone.
- Delete the paired phone via the "Phone" menu.

(See "Bluetooth® function" (P.4-21) or "Pairing, unpairing a phone" (P.4-24).)

Making, receiving a call

Calling a contact from phonebook:

When pairing your phone, your phonebook is automatically uploaded into the audio system.

- Display the "Phone" menu by pressing the button ⑩ on the front panel of the audio system.
- Select "Phone Book" by turning the dial ⑫ on the front panel of the audio system.
- Confirm by pressing the dial ⑫ on the front panel of the audio system.
- Select a contact to call from the list, then confirm by pressing the dial ⑫ on the front panel of the audio system to start the call.

NOTE:

To return to the previous screen, press the button ⑮ on the front panel of the audio system.

Calling a contact from the call log:

- Display the call log by pressing the button ⑩ on the front panel of the audio system, then select "Call Lists".
- Select the "Dialed Call", "Received Call" or "Missed Call" menu by turning the dial ⑫ on the front panel of the audio system.
- Confirm by pressing the dial ⑫ on the front panel of the audio system.

The call log will appear on the audio system screen.

- Select the contact or number to call, then confirm by pressing the dial ⑫ on the front panel to start the call.

NOTE:

- **It is recommended that you stop your vehicle before entering a number or searching for a contact.**
- **The system does not support twin SIM cards and three way calling when your telephone is connected. If you receive a call when you are on another call, this new call is automatically rejected.**

Making a call by dialing a number:

- Display the "Phone" menu by pressing the button ⑩ on the front panel of the audio system, then select "Call Number".
- Dial the desired number using the numeric keypad by turning and pressing the dial ⑫ on the front panel of the audio system, then select "☎".

You can call the last number dialed by pressing and holding the button ⑩ on the front panel of the audio system.

Receiving a call:

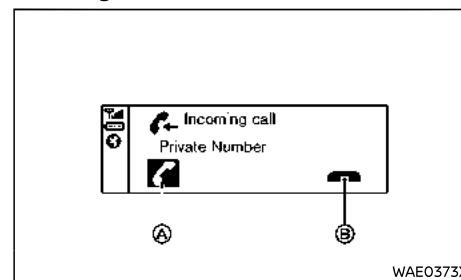

When receiving a call, the caller's number is displayed on the audio system display (this function depends on the options you have subscribed to with your phone service provider).

If the caller's number is in one of the memories, the name of the caller is displayed instead of the number.

If the caller's number cannot be displayed, the message "Private Number" will appear on the audio system display.

To accept an incoming call:

- Select A by turning and pressing the dial ⑫ on the front panel of the audio system.

To reject an incoming call:

- Select B by turning and pressing the dial ⑫ on the front panel of the audio system.

During a call:

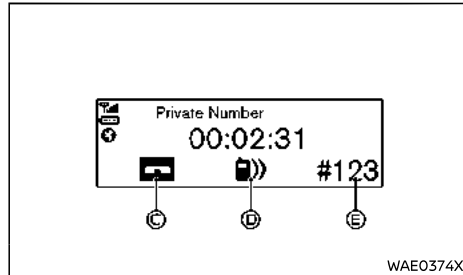

You can:

- Adjust the volume by pressing the buttons ① and ③ on the front panel of the audio system.
- Hang up by pressing the button ⑩ on the front panel of the audio system.

By turning the dial ⑫ on the front panel of the audio system, you can:

- Hang up (select and press the icon ③)
- Switch the conversation from your audio system to your phone (select and press the icon ④)
- Control the keypad of your phone from the audio system (select and press the icon ⑤).

System settings

Display of radio texts:

To display radio text:

- Press the button ⑩ on the front panel of the audio system.
- Select the "Radio" menu using the dial ⑫ on the front panel of the audio system.

- Confirm by pressing the dial ⑫ on the front panel of the audio system.

The radio text display may contain a maximum of sixty-four characters.

NOTE:

If there is no information provided, the audio system display will show the message "No message".

Audio settings:

To display audio settings:

- Press the button ⑩ on the front panel of the audio system.
- Select "parameters" using the dial ⑫ on the front panel of the audio system.
- Press the dial ⑫ on the front panel of the system to confirm and display the audio settings menu.
- Select "Audio" to access the different sections in the following order:
 - "Bass"
 - "Treble"
 - "Fader" (front/rear balance)
 - "Balance" (left/right balance)

You can change the value of each setting by turning the dial ⑫ on the front panel of the audio system.

Press the dial ⑫ on the front panel of the audio system to confirm and return to the previous selection.

The system automatically exits the menu if there is no activity for a few seconds. You can also exit the menu by pressing the button ⑮ on the front panel of the audio system.

Settings AUX:

From the "parameters" menu, turn the dial ⑫ on the front panel of the audio system, then select "Aux In" to access the different sections in the following order:

- "HI"
- "MID"
- "LO"

The values for each setting are as follows:

- "HI" (300 mV)
- "MID" (600 mV)
- "LO" (1200 mV)

Choosing the language:

Access "Language" in the "parameters" menu, then choose the desired language.

Default settings:

To return to the default settings:

- Display the settings menu by pressing the button ⑩ on the front panel of the audio system.
- Select the "parameters" menu using the dial ⑫ on the front panel of the audio system.
- Press the dial ⑫ on the front panel of the audio system to display the settings menu, then select "Default audio".

A message will appear on the audio system display asking you to confirm your selection. After selecting this item, all the audio system settings return to their default values.

Phone settings:

To display the phone settings menu, press the button ⑩ on the front panel of the audio system.

The system automatically exits the menu if there is no activity for a few seconds. You can also exit the menu by pressing the button ⑮ on

the front panel of the audio system.

Security code:

Your audio system is protected by a security code (supplied by a NISSAN dealer). This is used to electronically lock the audio system when the power is cut (battery disconnected, system disconnected, fuse blown etc.).

To operate the audio system, you must enter the secret four-digit code.

Make a note of the code and keep it in a safe place. If you lose it, please consult a NISSAN dealer.

Entering the code

To enter the code:

- Press the button ④ on the front panel of the audio system to switch on the system. The message "Radio Code" followed by "0000" will appear on the display.
- To set the value of the first flashing digit, press button 1 on the keypad ⑤ on the front panel of the audio system until you reach the desired number.
- Set the following digits on buttons 2, 3 and 4 of the keypad ⑤ on the front panel of the audio system in the same way.

After selecting the fourth digit, press and hold button 6 on the keypad ⑤ on the front panel of the audio system.

The system is unlocked automatically once the full code has been entered.

Entering the code incorrectly

If there is an error when entering the code, the message "Wait" will appear on the audio system display.

Wait around 60 seconds then re-enter the code.

Each time the code is entered incorrectly, the

time required before the code can be re-entered is doubled.

Steering wheel control buttons

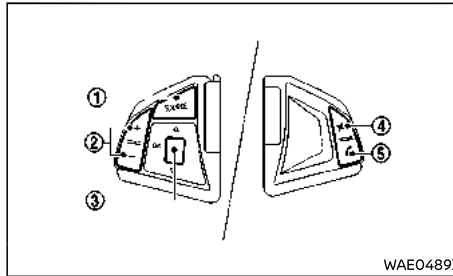

1. SOURCE button
 - Push the SOURCE button to change the mode to available audio source.
2. Volume control +/- buttons
 - Push the buttons to increase or decrease the volume.
3. Scroll dial
 - Scroll the dial upward or downward and then push the dial to select a station, track, menu or folder when they are listed on the display.
4. Mute button
 - Push the Mute button to mute/unmute.
5. Phone send/end button
 - Push to take a call or to hang up the call.
 - Reject an incoming call by pushing the button for more than 5 seconds when receiving an incoming call.
 - Redial the last outgoing call by pushing the button for more than 5 seconds.

Troubleshooting

Description	Possible causes	Solutions
No sound can be heard.	The volume is set to minimum or pause.	Increase the volume or deactivate pause.
The audio system does not work and the display does not light up.	The audio system is not switched on.	Switch the audio system on.
	The audio system fuse has blown.	Replace the fuse. (See "Fuses" (P.8-19).)
The audio system does not work but the display lights up.	The volume is set to minimum.	Push the VOL + button on the control panel or volume control + button on the steering wheel.
	Speaker short circuit.	Consult a NISSAN dealer.
No sound comes out of the left- or right-hand speakers when using the radio or a CD.	The sound balance setting (left/right) is incorrect.	Correct the sound balance setting.
	Speaker disconnected.	Consult a NISSAN dealer.
Poor radio reception or no reception.	The vehicle is too far from the transmitter to which the radio is tuned (background noise and interference).	Find another transmitter with better reception in your area or deactivate the "RDS-AF" function.
	The reception is disrupted by interference from the engine.	Consult a NISSAN dealer.
	The aerial is damaged or not connected.	Consult a NISSAN dealer.
The phone does not connect to the audio system.	<ul style="list-style-type: none"> ● Your phone is off. ● Your phone's battery is flat. ● Your phone has not yet been paired to the hands-free phone system. ● The Bluetooth® on your phone and on the audio system have not been activated. ● The phone is not configured to accept the audio system's connection request. 	<ul style="list-style-type: none"> ● Switch on your phone. ● Recharge your phone's battery. ● Pair your phone to the hands-free phone system. ● Activate the Bluetooth® on your phone and the audio system. ● Configure the phone to accept the audio system's connection request.
The Bluetooth® portable audio player does not connect to the system.	<ul style="list-style-type: none"> ● Your audio player is off. ● Your audio player's battery is flat. ● Your audio player has not previously been paired to the audio system. ● The Bluetooth® of your portable audio player and of the audio system have not been activated. ● The portable audio player is not configured to accept the audio system's connection request. ● Music does not start to play from your audio player. 	<ul style="list-style-type: none"> ● Switch on your portable audio player. ● Recharge your audio player's battery. ● Pair your audio player to the audio system. ● Activate Bluetooth® on your audio player and the audio system. ● Configure the portable player to accept the audio system's connection request. ● Depending on your phone's degree of compatibility, music may need to be played from your audio player.

Description	Possible causes	Solutions
The message "Low battery" appears.	Using your hands-free phone system for prolonged periods will discharge your phone's battery more quickly.	Recharge your phone's battery.

MULTIMEDIA SYSTEM (if equipped)

GENERAL INFORMATION

Your vehicle's multimedia system performs the following functions:

- Radio
- Plays music from connected audio sources
- Hands-free phone
- Smartphone connection

USER PRECAUTIONS

Precautions during use

It is essential to follow the precautions below when using the system, both in the interest of safety and to prevent material damage.

You must always comply with the laws of the country in which you are travelling.



CAUTION:

Precautions when operating the system

- Operate the controls (on the instrument panel or the steering wheel) and read the information on the screen only when road conditions allow.
- Set the volume to a reasonable level so that outside noise can be heard.

Precautions concerning the equipment

- Do not attempt to dismantle or modify the system, as there is a risk of damage to equipment and fire.
- Contact a NISSAN dealer in the event of malfunction and for all operations involving disassembly.
- Do not insert foreign bodies into the player.

- Do not use products containing alcohol and/or spray fluids on the area.

Precautions when using the phone

- There are laws which govern the use of phones in vehicles. They do not necessarily authorise the use of hands-free phone systems under all driving conditions. Drivers must be in control of their vehicles at all times.
- Using a phone while driving is a significant distraction and risk factor during all stages of use (dialing, communicating, searching for a number in the handset memory, etc.).

NOTE:

The description of the models given in this manual is based on the specifications at the time of writing.

Depending on the make and model of your phone, some functions may be partially or completely incompatible with your vehicle's multimedia system.

For more details, please consult a NISSAN dealer.

BASIC OPERATION

Control buttons

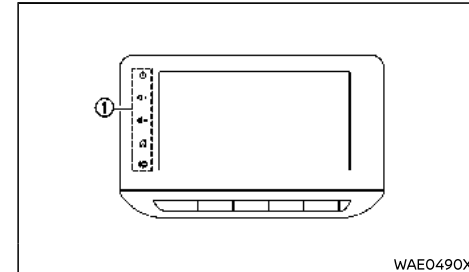

Buttons ① on the left side of the screen can be used to operate the multimedia system.

Buttons	Function
	Touch to turn on/off the multimedia system. Touch and hold to restart the system.
	Touch or touch and hold to adjust the volume.
	Touch to return to the Home menu screen.
	Touch to activate the camera screen. (See "Rear view monitor" (P.4-2) or "Around View Monitor" (P.4-7).)

Turning stand-by mode on/off

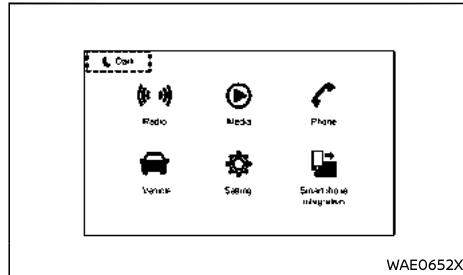

Example

Touch the “Dark” key on the upper left corner of the screen to change the screen to the stand-by mode.

Touch the screen to exit the stand-by mode.

USB connection port

The port for USB connection is located at the lower part of the instrument panel.

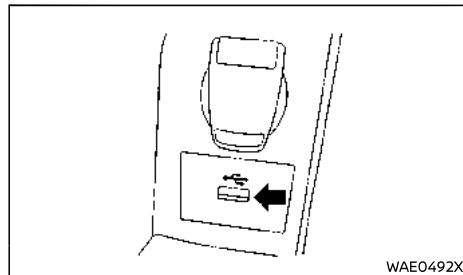

Insert a USB device or an iPod connector into this port.

Refer to your device manufacturer’s owner information regarding the proper use and care

of the device.

WARNING:

Do not connect, disconnect or operate the USB device while driving. Doing so can be a distraction. If distracted you could lose control of your vehicle and cause an accident or serious injury.

CAUTION:

- Do not force the USB device into the USB connection port. Depending on the USB connection port, inserting the USB device tilted or upside down may damage the port. Make sure that the USB device is connected correctly into the USB connection port.
- Do not grab the USB connection port cover (if equipped) when pulling the USB device out of the port. This could damage the port and the cover.
- Do not leave the USB cable in a place where it can be pulled unintentionally. Pulling the cable while it is connected may damage the port.
- The USB connection port can provide 1 A charging circuit for your phone device . If the charging circuit of your device is more than 1 A, it is recommended to charge your device by power outlet converter, or your device will lose power quickly sometimes.

Switches on the steering wheel

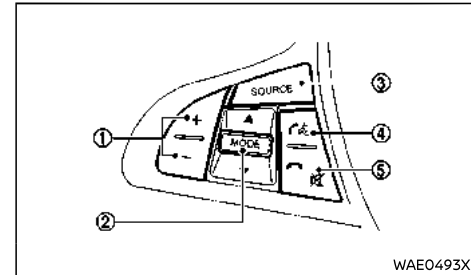

Switches on the left side of the steering wheel can be used to operate the multimedia system.

Switches	Function
①	Push to adjust the volume.
②	Push to change the subordinate menu keys on the Radio screen or Media screen. Tilt to change the radio frequency or tracks.
③	Push to change the audio source.
④	When a Bluetooth®, Android Auto or Apple CarPlay device is connected, push to activate/deactivate the voice recognition session. When no device is connected, pushing the button will prompt you to pair a device. For the phone operation, push to take a call.

Switches	Function
⑤	Push to mute the sound of an audio source. For the phone operation, push to reject or hang up the call.

Main menus

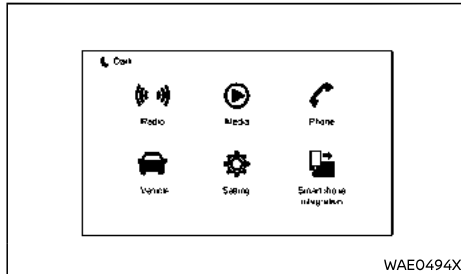

Example

Touch the “” button to display the Home menu screen.

Available main menus:

- Radio
- Media
- Phone
- Vehicle (if equipped)
- Driving Eco (if equipped)
- Setting
- Smartphone integration

Display

Selecting any of the main menus will display the screen similar to the illustration below.

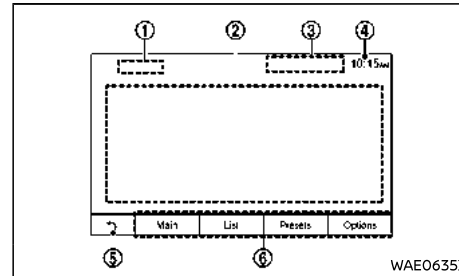

Example

- ① Mode selection area
 - Displays the selected mode.
 - When the mode selection area is touched, a drop-down menu will appear.
- ② Item information area
 - Shows the contents of a menu item and related information.
- ③ Connected device information area
 - If the Bluetooth® system is activated, various information of the connected device such as the reception level, battery level, etc. is displayed.
 - You can jump directly to the Android Auto/Apple CarPlay (if equipped) screen by touching the Android Auto/Apple CarPlay icon.
- ④ Time area
 - Displays the current time.
- ⑤ Back key
 - Goes back to the previous screen when touched.

⑥ Subordinate menu keys

- Displays subordinate menus of the currently selected main menu.

Bluetooth® device registration and connection
Before using your Bluetooth® devices, perform the following setup.

Registration:



To register your device, perform the following.

1. Touch the “” key on the Home menu screen. A registered device list screen will be displayed.
2. Touch the “+ Add Devices” key on the screen. A pop-up message will be displayed.
3. Follow the prompts to register your device.

Your Bluetooth® phone device can also be registered from the “” menu on the Home menu screen.

Connection:

To connect your registered device with the multimedia screen, perform the following.

1. Touch the “” key on the Home menu screen. A registered device list screen will be displayed.
2. Touch the “” icon by the name of the device you prefer to connect. A pop-up message will be displayed.
3. Follow the prompts to connect your device.

Your Bluetooth® phone device can also be connected from the “” menu on the Home menu screen.

AVAILABLE FUNCTIONS

Main functions that can be operated from the main menus are explained here. Main menus displayed on the Home menu screen vary depending on the specification/market.

Radio

Touching the “(())” key on the Home menu screen will display the Radio screen.

Selecting radio band:

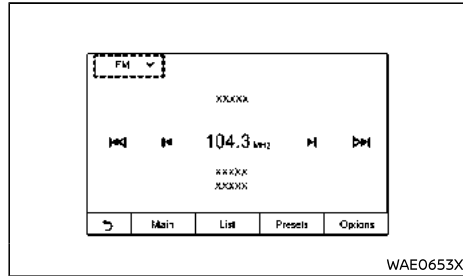

Example

Touch the “∨” key on the upper left corner of the Radio screens to select a radio band (FM, AM or DAB (if equipped)).

Selecting subordinate menu:

Subordinate menus below are available in the Radio menu. Touch the keys on the bottom of the Radio screens to display the preferred subordinate menus.

Available menus may vary depending on the selected radio band.

Menu	Action
Main	Main operations such as selecting radio stations can be performed.
List	Available radio stations are listed and can be selected.
Presets	Preferred stations can be preset by touching and holding one of the preset keys while the preferred station is playing. Touch one of the preset keys briefly to play the station.
Options	Various radio settings (updating the radio station list, turning on/off the traffic announcements, etc.) can be changed.

Media

Touching the “▶” key on the Home menu screen will display the Media screen.

Sources connected via USB connection port, Bluetooth® and Wi-Fi (for wireless Android Auto/Apple CarPlay) can be operated on the Media screens.

Availability of Android Auto/Apple CarPlay functions depends on the market/model.

Selecting connected source:

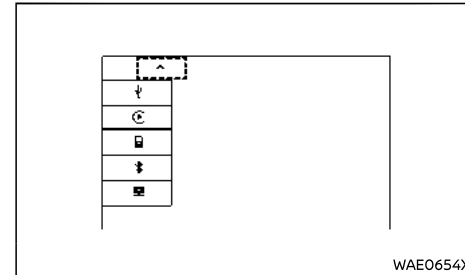

Example

Touch the “∨” key on the upper left corner of the Media screens to select a source.

	Sources connected via USB port
	This icon is shown when neither Android Auto nor Apple CarPlay is connected. Touching this icon does not change the display.
	Smartphone integration (Apple CarPlay, Android Auto, etc.)
	Devices with integrated iPod
	Bluetooth® devices
	Video in USB flash drive (MP4 file)

To operate an external device that requires USB connection, connect the device via USB connection port. (See “USB connection port” (P.4-32).)

To operate Bluetooth® device, the device must first be registered and connected. (See “Bluetooth® device registration and connection”

(P.4-33.)

Selecting subordinate menu:

The following subordinate menus are available in the Media menu. Touch the keys on the bottom of the Media screens to select the preferred subordinate menu.

Menu	Action
Player	Main operations such as fast-forwarding and rewinding tracks, changing repeat/shuffle mode, etc. can be performed.
List	Folders and tracks are listed and can be selected.

Bluetooth® Hands-Free Phone

To use the Bluetooth® Hands-Free Phone, the phone device must first be registered and connected. (See "Bluetooth® device registration and connection" (P.4-33).)

When a phone device is not registered/connected, touching the  key on the Home menu screen will display a pop-up screen. Follow the prompts to register and connect your phone device.

Selecting subordinate menu and making a call:



After touching the  key on the Home menu screen when a phone device is connected, following subordinate menus are available. Touch the keys on the bottom of the Phone screens to select the preferred subordinate menu and make a call.

Menu	Action
Call log	Displays call history.
Phone Book	Displays a phone book.
Dial	Displays a keyboard for dialing.

Receiving a call:

When a call is received, a pop-up screen is displayed on the multimedia system screen with caller information. Touch the "Accept" key to take a call, and touch the "Reject" key to reject the call.

Using voice recognition:

Some of the operations can be performed using voice recognition function. To start a voice recognition session, push the  switch on the steering wheel. To end the session, push the  switch again.

Vehicle (if equipped)

Touching the  key on the Home menu screen will display the Vehicle screen. Following functions are available.

Menu	Action
Vehicle settings	Rear view monitor can be turned on/off by changing the setting with the "Rear view camera" key.
Driving Eco	Eco-driving support function can be used.

Driving Eco (if equipped)

Touching the  key on the Home menu screen will display the Driving Eco screen.

Following functions are available. Touch the keys on the bottom of the Driving Eco screens to select the preferred menu.

Menu	Action
Trip report	Shows the data saved from the last journey.
Eco scoring	Shows the score of eco-driving performance.
Eco coaching	Provides driving advice to optimize fuel consumption.

Setting

Touching the  key on the Home menu screen will display the Setting screen.

Selecting subordinate menu:

The following subordinate menus are available in the Setting menu. Touch the keys on the bottom of the Setting screens to select the preferred menu.

Menu	Action
Audio	Audio settings can be changed.
Display	Display settings can be changed.
Devices	Devices settings such as Wi-Fi connections can be changed.
System	Basic system settings such as language, clock/units settings can be changed.

Smartphone integration

Touching the "☰" key on the Home menu screen will display the Smartphone integration screen which shows the connected devices list.

Selecting subordinate menu:

The following subordinate menus are available in the Smartphone integration menu. Touch the keys on the bottom of the Smartphone integration screens to select the preferred subordinate menu.

Menu	Action
Device	List of registered devices are displayed. Compatible devices can be registered and connected.
Delete	Registered devices can be deleted.

Bluetooth®:

On the "Device" subordinate menu screen, touch the "📶" icon to operate Bluetooth® devices.

Android Auto™ (if equipped):

On the "Device" subordinate menu screen, touch the "📶" icon to operate Android Auto. Android Auto can be used when a compatible device is connected via a USB cable. Depending on the market/model, it can also be used wirelessly when the device is connected via Bluetooth® and Wi-Fi.

Apple CarPlay (if equipped):

On the "Device" subordinate menu screen, touch the "📶" icon to operate Apple CarPlay. Apple CarPlay can be used when a compatible device is connected via a USB cable. Depending on the market/model, it can also be used wirelessly when the device is connected via

Bluetooth® and Wi-Fi.

CAR PHONE OR CB RADIO

When installing a CB, ham radio or a car phone in your vehicle, be sure to observe the following cautions, otherwise the new equipment may adversely affect the Engine Control System and other electronic parts.



CAUTION:

- Keep the antenna as far away as possible from the Electronic Control Module.
- Keep the antenna wire at least 20 cm (8 in) away from the Engine Control harnesses. Do not route the antenna wire next to any harnesses.
- Adjust the antenna standing wave ratio as recommended by the manufacturer.
- Connect the ground wire from the radio chassis to the body.
- For details, consult a NISSAN dealer.

ANTENNA

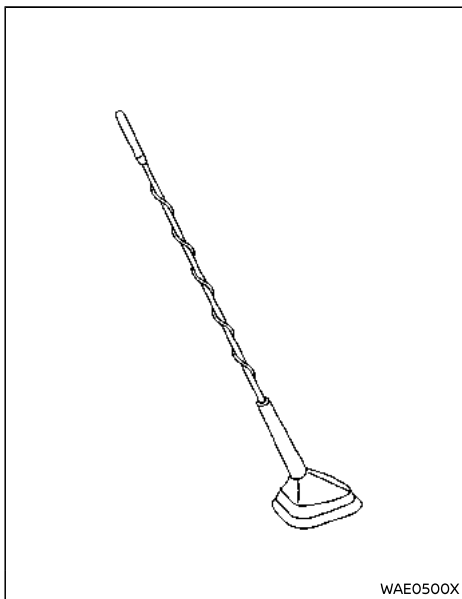

- The vehicle enters an automatic car wash.
- The vehicle enters a garage with a low ceiling.
- The vehicle is covered with a car cover.

The antenna can be removed if necessary.

Hold the bottom of the antenna and remove by turning counterclockwise.

To install the antenna, turn the antenna clockwise and tighten.



CAUTION:

To avoid damaging or deforming the antenna, be sure to remove the antenna under the following conditions.

MEMO

4-38 **Monitor, heater and air conditioner, and audio system**

5 Starting and driving

Break-in schedule	5-2	Driving with Manual Transmission (MT)	5-13
Before starting engine	5-2	Vehicle Dynamic Control (VDC) system (if equipped)	5-15
Precautions when starting and driving	5-2	Vehicle Dynamic Control (VDC) OFF switch (if equipped)	5-15
Exhaust gas (carbon monoxide)	5-3	Hill start assist system (if equipped)	5-16
Three-way catalyst	5-3	Cruise control (if equipped)	5-17
Tire Pressure Monitoring System (TPMS) (if equipped)	5-3	Precautions on cruise control	5-17
Turbocharger system (if equipped)	5-5	Cruise control operations	5-17
Care when driving	5-5	Fuel Efficiency and Carbon Dioxide Reduction driving tips	5-19
Engine cold start period	5-5	Increasing fuel economy and reducing Carbon Dioxide emissions	5-20
Loading luggage	5-5	Parking	5-20
Driving in wet conditions	5-5	Parking sensor (sonar) system	5-22
Driving in winter conditions	5-6	Trailer towing	5-23
Ignition switch (model without Intelligent Key system)	5-6	Electric power steering	5-23
Manual Transmission (MT)	5-6	Brake system	5-24
Key positions	5-6	Brake precautions	5-24
Steering lock	5-6	Brake assist	5-24
Push-button ignition switch (model with Intelligent Key system)	5-7	Anti-lock Braking System (ABS)	5-24
Precautions on push-button ignition switch operation	5-7	Vehicle security	5-25
Intelligent Key system	5-7	Cold weather driving	5-26
Steering lock	5-7	Battery	5-26
Ignition switch positions	5-8	Engine coolant	5-26
Intelligent Key battery discharge	5-8	Tire equipment	5-26
Starting engine (model without Intelligent Key system)	5-9	Special winter equipment	5-26
Starting engine (model with Intelligent Key system)	5-9	Parking brake	5-26
Driving vehicle	5-10	Corrosion protection	5-27
Driving with Continuously Variable Transmission (CVT)	5-10		



BREAK-IN SCHEDULE

During the first 1,000 km (600 miles) (BR10 HS engine model) or 1,600 km (1,000 miles) (HRA0DET engine model), follow these recommendations to obtain maximum engine performance and ensure the future reliability and economy of your new vehicle. Failure to follow these recommendations may result in shortened engine life and reduced engine performance.

- Do not drive at a constant speed, either fast or slow, for long periods of time.
- Do not run the engine over 3,000 to 3,500 rpm (BR10 HS engine model) or 4,000 rpm (HRA0DET engine model).
- Do not accelerate at full throttle in any gear.
- Do not start quickly.
- Do not brake hard as much as possible.

BEFORE STARTING ENGINE



WARNING:

The driving characteristics of your vehicle will change remarkably by any additional load and its distribution, as well as by adding optional equipment (roof racks, etc.). Your driving style and speed must be adjusted according to the circumstances. Especially when carrying heavy loads, your speed must be reduced adequately.

- Make sure the area around the vehicle is clear.
- Visually inspect tires for their appearance and condition. Measure and check the tire pressure for proper inflation.
- Check that all windows and lights are clean.
- Adjust the seat and head restraint positions.
- Adjust the inside and outside rearview mirror positions.
- Fasten your seat belt and ask all passengers to do the same.
- Check that all doors are closed.
- Check the operation of the warning lights when the ignition switch is placed in the "ON" position.
- Maintenance items in the "8. Maintenance and do-it-yourself" section should be checked periodically.

PRECAUTIONS WHEN STARTING AND DRIVING



WARNING:

- Never leave children or adults who would normally require the support of others alone in your vehicle. Pets should not be left alone either. They could unknowingly activate switches or controls and inadvertently become involved in a serious accident and injure themselves. On hot, sunny days, temperatures in a closed vehicle could quickly become high enough to cause severe or possibly fatal illness to people or animals.
- Properly secure all luggage to help prevent it from sliding or shifting. Do not place luggage higher than the seatbacks. In a sudden stop or collision, unsecured luggage could cause personal injury.

NOTE:

During the first few months after purchasing a new vehicle, if you smell strong odors of Volatile Organic Compounds (VOCs) inside the vehicle, ventilate the passenger compartment thoroughly. Open all the windows before entering or while in the vehicle. In addition, when the temperature in the passenger compartment rises, or when the vehicle is parked in direct sunlight for a period of time, turn off the air recirculation mode of the air conditioner and/or open the windows to allow sufficient fresh air into the passenger compartment.

EXHAUST GAS (carbon monoxide)



WARNING:

- Do not breathe exhaust gas; it contains colorless and odorless carbon monoxide. Carbon monoxide is dangerous. It can cause unconsciousness or death.
- If you suspect that exhaust fumes are entering the vehicle, drive with all windows fully open, and have the vehicle inspected immediately.
- Do not run the engine in closed spaces such as a garage.
- Do not park the vehicle with the engine running for an extended period of time.
- Keep the back door closed while driving, otherwise exhaust gas could be drawn into the passenger compartment. If you must drive with the back door open, follow these precautions:
 - Open all the windows.
 - Turn the air recirculation mode off and set the fan speed control to the highest level to circulate the air.
- If a special body or other equipment is added for recreational or other usage, follow the manufacturer's recommendation to prevent carbon monoxide entry into the vehicle. (Some recreational vehicle appliances such as stoves, refrigerators, heaters, etc. may also generate carbon monoxide.)
- The exhaust system and body should be inspected by a qualified mechanic whenever:
 - Your vehicle is raised while being serviced.

- You suspect that exhaust fumes are entering into the passenger compartment.
- You notice a change in the sound of the exhaust system.
- You have had an accident involving damage to the exhaust system, underbody, or rear of the vehicle.

THREE-WAY CATALYST



WARNING:

- The exhaust gas and the exhaust system are very hot. Keep people, animals and flammable materials away from the exhaust system components.
- Do not stop or park the vehicle over flammable materials such as dry grass, wastepaper or rags. They may ignite and cause a fire.

The three-way catalyst is an emission control device installed in the exhaust system. Exhaust gas in the three-way catalyst is burned at high temperatures to help reduce pollutants.



CAUTION:

- Do not use leaded gasoline. (See "Recommended fluids/lubricants and capacities" (P.9-2).) Deposits from leaded gasoline seriously reduce the ability of the three-way catalyst to help reduce exhaust pollutants and/or damage the three-way catalyst.
- Keep your engine tuned up. Malfunctions in the ignition, fuel injection, or electrical systems may cause overrich fuel to flow into the three-way catalyst, causing it to overheat. Do not keep driving if the

engine misfires, or if noticeable loss of performance or other unusual operating conditions are detected. Have the vehicle inspected promptly by a NISSAN dealer.

- Avoid driving with an extremely low fuel level. Running out of fuel could cause the engine to misfire, damaging the three-way catalyst.
- Do not race the engine while warming it up.
- Do not push or tow your vehicle to start the engine.

TIRE PRESSURE MONITORING SYSTEM (TPMS) (if equipped)

Each tire, including the spare (if provided), should be checked monthly when cold and inflated to the inflation pressure recommended by the vehicle manufacturer on the vehicle placard or tire inflation pressure label. (If your vehicle has tires of a different size than the size indicated on the vehicle placard or tire inflation pressure label, you should determine the proper tire inflation pressure for those tires.)

As an added safety feature, your vehicle has been equipped with a Tire Pressure Monitoring System (TPMS) that illuminates a low tire pressure warning light and a telltale (if equipped) when one or more of your tires is significantly under-inflated. Accordingly, when the low tire pressure warning light illuminates, you should stop and check your tires as soon as possible, and inflate them to the proper pressure. Driving on a significantly under-inflated tire causes the tire to overheat and can lead to tire failure. Under-inflation also reduces fuel efficiency and tire tread life, and may affect the vehicle's handling and stopping ability.

Please note that the TPMS is not a substitute

for proper tire maintenance, and it is the driver's responsibility to maintain correct tire pressure, even if under-inflation has not reached the level to trigger illumination of the TPMS low tire pressure warning light.

Your vehicle has also been equipped with a TPMS malfunction indicator to indicate when the system is not operating properly. The TPMS malfunction indicator is combined with the low tire pressure warning light. When the system detects a malfunction, the warning light will flash for approximately one minute and then remain continuously illuminated. This sequence will continue upon subsequent vehicle start-ups as long as the malfunction exists. When the malfunction indicator is illuminated, the system may not be able to detect or signal low tire pressure as intended. TPMS malfunctions may occur for a variety of reasons, including the installation of replacement or alternate tires or wheels on the vehicle that prevent the TPMS from functioning properly. Always check the TPMS malfunction warning light after replacing one or more tires or wheels on your vehicle to ensure that the replacement or alternate tires and wheels allow the TPMS to continue to function properly.

Additional information

- Since the spare tire is not equipped with the TPMS, the TPMS does not monitor the tire pressure of the spare tire.
- The TPMS will activate only when the vehicle is driven at speeds above 25 km/h (16 MPH). Also, this system may not detect a sudden drop in tire pressure (for example a flat tire while driving).
- The low tire pressure warning light does not automatically turn off when the tire pressure is adjusted. After the tire is inflated to the recommended pressure, the vehicle

must be driven at speeds above 25 km/h (16 MPH) to activate the TPMS and turn off the low tire pressure warning light. Use a tire pressure gauge to check the tire pressure.

- The tire pressure low telltale (if equipped) appears in the vehicle information display when the low tire pressure warning light is illuminated and low tire pressure is detected. The telltale turns off when the low tire pressure warning light turns off. The telltale appears each time the ignition switch is placed in the "ON" position as long as the low tire pressure warning light remains illuminated. The telltale does not appear if the low tire pressure warning light illuminates to indicate a TPMS malfunction.
- Tire pressure rises and falls depending on the heat caused by the vehicle's operation and the outside temperature. Do not reduce the tire pressure after driving because the tire pressure rises after driving. Low outside temperature can lower the temperature of the air inside the tire which can cause a lower tire inflation pressure. This may cause the low tire pressure warning light to illuminate. If the warning light illuminates in low ambient temperature, check the tire pressure for all four tires.

For additional information, see "Low tire pressure warning light" (P.2-11).

- The system has to be reset with an inflation pressure equal to that written on the tire placard. (See "Tire placard" (P.9-8).) Otherwise it is a risk which is not giving a reliable warning in the event of a significant loss of pressure.

For additional information, see "Tyre Pressure screen" (P.2-17).



WARNING:

- **If the low tire pressure warning light illuminates while driving, avoid sudden steering maneuvers or abrupt braking, reduce vehicle speed, pull off the road to a safe location and stop the vehicle as soon as possible. Serious vehicle damage could occur and may lead to an accident and could result in serious personal injury. Check the tire pressure for all four tires. Adjust the tire pressure to the recommended COLD tire pressure shown on the tire placard to turn the low tire pressure warning light OFF. If the light still illuminates while driving after adjusting the tire pressure, a tire may be flat or the TPMS may be malfunctioning. If you have a flat tire, replace it with a spare tire as soon as possible. If no tire is flat and all tires are properly inflated, have the vehicle checked by a NISSAN dealer.**
- **Since the spare tire is not equipped with the TPMS, when a spare tire is mounted or a wheel is replaced, the TPMS will not function and the low tire pressure warning light will flash for approximately 1 minute. The light will remain on after 1 minute. Contact a NISSAN dealer as soon as possible.**
- **Replacing tires with those not originally specified by NISSAN could affect the proper operation of the TPMS.**
- **Do not inject any tire liquid or aerosol tire sealant into the tires, as this may cause a malfunction of the tire pressure sensors.**



CAUTION:

- **The TPMS may not function properly when the wheels are equipped with tire chains or the wheels are buried in snow.**
- **Do not place metalized film or any metal parts (antenna, etc.) on the windows. This may cause poor reception of the signals from the tire pressure sensors, and the TPMS will not function properly.**

Some devices and transmitters may temporarily interfere with the operation of the TPMS and cause the low tire pressure warning light to illuminate. Some examples are:

- Facilities or electric devices using similar radio frequencies are near the vehicle.
- If a transmitter set to similar frequencies is being used in or near the vehicle.
- If a computer (or similar equipment) or a DC/AC converter is being used in or near the vehicle.

Low tire pressure warning light may illuminate in the following cases.

- If the vehicle is equipped with a wheel and tire without TPMS.
- If the TPMS has been replaced and the ID has not been registered.
- If the wheel is not originally specified by NISSAN.

TURBOCHARGER SYSTEM (if equipped)

The turbocharger system uses engine oil for lubrication and cooling of its rotating components. The turbocharger turbine turns at extremely high speeds and it can reach an extremely high temperature. It is essential to maintain a clean supply of oil flowing through the turbocharger system. A sudden interruption of oil supply may cause a malfunction in the turbocharger.

To ensure prolonged life and performance of the turbocharger, it is essential to comply with the following maintenance procedure.



CAUTION:

- **Change the engine oil according to the recommended intervals shown in a separate maintenance booklet.**
- **Use only the recommended engine oil. See "Recommended fluids/lubricants and capacities" (P.9-2).**
- **If the engine has been operating at high rpm for an extended period of time, let it idle for a few minutes prior to turn off.**
- **Do not accelerate your engine to high rpm immediately after starting it.**

CARE WHEN DRIVING

Driving your vehicle to fit the circumstances is essential for your safety and comfort. As a driver, you should be the one who knows best how to drive in the given circumstances.

ENGINE COLD START PERIOD

Due to the higher engine speeds, when the engine is cold, extra caution must be exercised when selecting a gear during the engine warm-up period after starting the engine.

LOADING LUGGAGE

Loads and their distribution and the attachment of equipment (coupling devices, roof luggage carriers, etc.) will considerably change the driving characteristics of the vehicle. Your driving style and speed must be adjusted according to the circumstances.

DRIVING IN WET CONDITIONS

- Avoid accelerating or stopping suddenly.
- Avoid sharp turning or lane changing suddenly.
- Avoid following too close to the vehicle in front.

When water covers the road surface with water puddles, small water streams, etc., reduce speed to prevent hydroplaning which can cause skidding and loss of control. Worn tires will increase this risk.

DRIVING IN WINTER CONDITIONS

- Drive cautiously.
- Avoid accelerating or stopping suddenly.
- Avoid sharp turning or lane changing suddenly.
- Avoid sudden steering.
- Avoid following too close to the vehicle in front.

IGNITION SWITCH (model without Intelligent Key system)



WARNING:

Never remove the key or turn the ignition switch to the "LOCK" position while driving. The steering wheel will lock and could cause the driver to lose control of the vehicle. This could result in serious vehicle damage or personal injury.

MANUAL TRANSMISSION (MT)

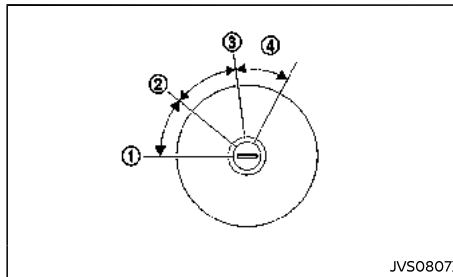

The ignition switch includes a device that helps prevent accidental removal of the key while driving.

The key can only be removed when the ignition switch is in the "LOCK" position ①.

KEY POSITIONS

LOCK (1)

- The ignition key can only be removed at this position.
- The steering lock can only be locked at this position.

ACC (2)

The electrical accessory power activates without the engine turned on.

ON (3)

The ignition system and the electrical accessory power activate without the engine turned on.

START (4)

The engine starter activates and the engine will start. The ignition switch, when released, will automatically turn to the "ON" position.



CAUTION:

As soon as the engine has started, release the ignition switch immediately.

STEERING LOCK

To lock steering wheel

1. Turn the ignition switch to the "LOCK" position.
2. Remove the key from the ignition switch.
3. Turn the steering wheel 1/6 of a turn clockwise from the straight up position.

To unlock steering wheel

1. Insert the key into the ignition switch.
2. Gently turn the ignition switch while rotating the steering wheel slightly right and left.

PUSH-BUTTON IGNITION SWITCH (model with Intelligent Key system)

PRECAUTIONS ON PUSH-BUTTON IGNITION SWITCH OPERATION



WARNING:

Do not operate the push-button ignition switch while driving the vehicle except in an emergency. (The engine will stop when the ignition switch is pushed 3 consecutive times or the ignition switch is pushed and held for more than 2 seconds.) The steering wheel will lock and could cause the driver to lose control of the vehicle. This could result in serious vehicle damage or personal injury.

Before operating the push-button ignition switch, be sure to move the shift lever to the "P" (Park) position (for Continuously Variable Transmission (CVT) model) or the shift lever to the "N" (Neutral) position (for Manual Transmission (MT) model).

INTELLIGENT KEY SYSTEM

The Intelligent Key system can operate the ignition switch without taking the key out from your pocket or bag. The operating environment and/or conditions may affect the Intelligent Key system operation.



CAUTION:

- Be sure to carry the Intelligent Key with you when operating the vehicle.
- Never leave the Intelligent Key inside the vehicle when you leave the vehicle.
- If the vehicle battery is discharged, the ignition switch cannot be switched from the "LOCK" position, and if the steering lock is engaged, the steering wheel cannot be moved. Charge the battery as

soon as possible. (See "Jump starting" (P.6-7).)

Operating range

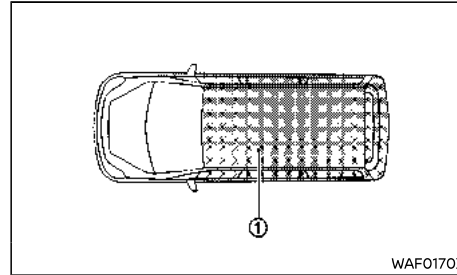

The Intelligent Key can only be used for starting the engine when the Intelligent Key is within the specified operating range ①.

When the Intelligent Key battery is almost discharged or strong radio waves are present near the operating location, the Intelligent Key system's operating range becomes narrower and may not function properly.

If the Intelligent Key is within the operating range, it is possible for anyone, even someone who does not carry the Intelligent Key, to push the ignition switch to start the engine.

- If the Intelligent Key is placed on the instrument panel, inside the glove box, door pocket or the corner of the interior compartment, the Intelligent Key may not function.
- If the Intelligent Key is placed near the door or window outside the vehicle, the Intelligent Key may function.

Continuously Variable Transmission (CVT) model
If the ignition switch is switched to the "LOCK" position, the shift lever cannot be moved from the "P" (Park) position. The shift lever can be moved if the ignition switch is in the "ON" position with the foot brake pedal depressed.

STEERING LOCK

The ignition switch is equipped with an anti-theft steering lock device.

To lock steering wheel

1. Push the ignition switch to stop the engine.
2. Open or close the driver's door. The ignition switch turns to the "LOCK" position.
3. Turn the steering wheel 1/6 of a turn to the right or left from the straight up position.

To unlock steering wheel

Push the ignition switch, and the steering wheel will be automatically unlocked.



CAUTION:

- If the battery of the vehicle is discharged, the push-button ignition switch cannot be switched from the "LOCK" position.
- If the ignition switch position does not change from the "LOCK" position, push the ignition switch again while rotating the steering wheel slightly to the right and left.

IGNITION SWITCH POSITIONS



WARNING:

Never push the ignition switch to stop the engine while driving. The steering wheel may lock and cause the driver to lose control of the vehicle, resulting in serious vehicle damage or personal injury.



CAUTION:

- Do not leave the vehicle for extended periods of time when the ignition switch is in the "ON" position and the engine is not running. This can discharge the battery.
- Use electrical accessories with the engine running to avoid discharging the vehicle battery. If you must use accessories while the engine is not running, do not use them for extended periods of time and do not use multiple electrical accessories at the same time.

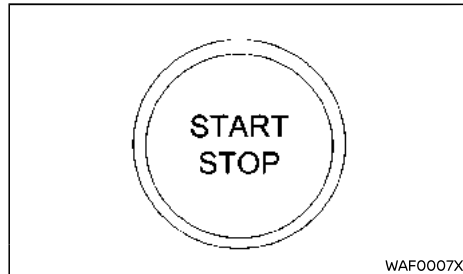

Push the ignition switch once to change to "ON".

The ignition switch will automatically return to

the "LOCK" position when the driver's door is either opened or closed.

ON position

The ignition system and the electrical accessory power activate at this position without the engine turned on.

The "ON" position has a battery saver feature that will turn off the ignition if the vehicle is not running for 3 minutes.

LOCK position

The ignition switch and steering lock can only be locked at this position.

INTELLIGENT KEY BATTERY DISCHARGE

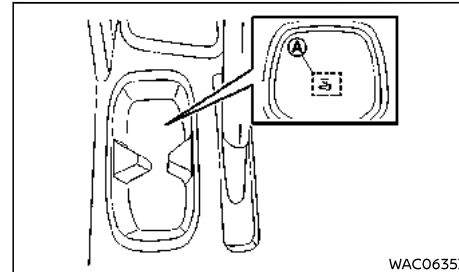

If the battery of the Intelligent Key is discharged, or environmental conditions interfere with the Intelligent Key operation, start the engine according to the following procedure:

1. Move the shift lever to the "P" (Park) (for CVT models) or "N" (Neutral) (for MT models) position.
2. Firmly depress the clutch pedal (for MT models) and the brake pedal.

3. Touch the Intelligent Key on the key communication symbol (A) at the bottom of the front cup holder.

4. Push the ignition switch while depressing the clutch pedal (for MT models) and the brake pedal. The engine will start.

After step 3 is performed, when the ignition switch is pushed without depressing the brake pedal, the ignition switch position will change to "ON".

NOTE:

If the Key Battery low warning (if equipped) appears on the vehicle information display, replace the battery as soon as possible. (See "Battery" (P-8-17).)

STARTING ENGINE (model without Intelligent Key system)

1. Apply the parking brake.
2. Depress the foot brake pedal.
3. Move the shift lever to the "N" (Neutral) position, and depress the clutch pedal to the floor while starting the engine.
4. Crank the engine with your foot off the accelerator pedal by turning the ignition switch to the "START" position.
5. Immediately release the ignition switch when the engine starts. If the engine starts, but fails to run, repeat the above procedures.

If the engine is very hard to start in extremely cold or hot weather, depress the accelerator pedal and hold it to help start the engine.



CAUTION:

- **Do not operate the starter for more than 15 seconds at a time. If the engine does not start, turn the ignition switch off and wait 10 seconds before cranking the engine again. Otherwise, the starter could be damaged.**
- **After 3 sequence of attempts, if the engine fails to start or requires many attempts to start, contact a NISSAN dealer.**
- **Do not operate the starter if the engine is running or while a gear is engaged. It may damage the starter.**
- **If it becomes necessary to start the engine with a booster battery and jumper cables, the instructions and cautions contained in the "6. In case of emergency" section should be carefully followed.**

6. Allow the engine to idle for at least 30 seconds after starting the engine to warm-up. Drive at moderate speeds for a short distance first, especially in cold weather.



CAUTION:

Do not leave the vehicle unattended while the engine is warming up.

STARTING ENGINE (model with Intelligent Key system)

1. Apply the parking brake.
2. **Continuously Variable Transmission (CVT) model:**

Move the shift lever to the "P" (Park) or the "N" (Neutral) position.

The starter is designed to operate only when the shift lever is in the proper position.

Manual Transmission (MT) model:

Move the shift lever to the "N" (Neutral) position.

The starter is designed to not operate unless the brake pedal is fully depressed.

The Intelligent Key must be carried when operating the ignition switch.

3. Place the ignition switch in the "ON" position. Firmly depress the brake pedal (CVT model) or the clutch pedal (MT model) and push the ignition switch to start the engine.
4. Immediately release the ignition switch when the engine starts. If the engine starts, but fails to run, repeat the above procedures.

If the engine is very hard to start in extremely cold or hot weather, depress the accelerator pedal and hold it. Push the ignition switch for up to 15 seconds while holding. Release the accelerator pedal when the engine starts.



CAUTION:

- **As soon as the engine has started, release the ignition switch immediately.**
- **Do not operate the starter for more than 20 seconds at a time. If the engine does not start, wait 20 seconds before cranking the engine again. Otherwise, the**

DRIVING VEHICLE

starter could be damaged.

- After 3 sequence of attempts, if the engine fails to start or requires many attempts to start, contact a NISSAN dealer.
 - If it becomes necessary to start the engine with a booster battery and jumper cables, the instructions and cautions contained in the "6. In case of emergency" section should be carefully followed.
5. Allow the engine to idle for at least 30 seconds after starting the engine to warm-up. Drive at moderate speeds for a short distance first, especially in cold weather.



CAUTION:

Do not leave the vehicle unattended while the engine is warming up.

6. To stop the engine, move the shift lever to the "P" (Park) position (CVT model) or move the shift lever to the "N" (Neutral) position (MT model), apply the parking brake and push the ignition switch to stop the engine.

DRIVING WITH CONTINUOUSLY VARIABLE TRANSMISSION (CVT)

The Continuously Variable Transmission (CVT) in your vehicle is electronically controlled to produce maximum power and smooth operation.

The recommended operating procedures for this transmission are shown on the following pages. Follow these procedures for maximum vehicle performance and driving enjoyment.



WARNING:

Do not downshift abruptly on slippery roads. This may cause a loss of control.



CAUTION:

- The cold engine idle speed is high, so use caution when shifting the transmission into a forward or reverse position before the engine has warmed up.
- Avoid revving up the engine while the vehicle is stopped. This could cause unexpected vehicle movement.
- Never shift to either the "P" (Park) or "R" (Reverse) position while the vehicle is moving forward and "P" (Park) or "D" (Drive) position while the vehicle is reversing. This could cause an accident or damage the transmission.
- Start the engine in either the "P" (Park) or "N" (Neutral) position. The engine will not start in any other position. If it does, have your vehicle checked by a NISSAN dealer.
- Except in an emergency, do not shift to the "N" (Neutral) position while driving. Coasting with the transmission in the "N" (Neutral) position may cause serious da-

mage to the transmission.

- Shift into the "P" (Park) position and apply the parking brake when at a standstill for longer than a short waiting period.
- Keep the engine at idling speed while shifting from the "N" (Neutral) position to any driving position.
- When stopping the vehicle on an uphill grade, do not hold the vehicle by depressing the accelerator pedal. The foot brake pedal should be depressed in this situation.

Starting vehicle

1. After starting the engine, fully depress the foot brake pedal before moving the shift lever out of the "P" (Park) position.
2. Keep the foot brake pedal depressed, push the shift lever button and move the shift lever to a driving position.
3. Release the parking brake, the foot brake pedal, and then gradually start the vehicle in motion.

The CVT is designed so the foot brake pedal **MUST** be depressed before shifting from the "P" (Park) position to any driving position while the ignition switch is in the "ON" position.

The shift lever cannot be moved out of the "P" (Park) position and into any of the other positions if the ignition switch is placed in the "LOCK", "OFF" or "ACC" position or if the key is removed from the vehicle.



CAUTION:

- **DEPRESS THE FOOT BRAKE PEDAL** - Shifting the shift lever to "D" (Drive) or "R" (Reverse) without depressing the foot

brake pedal causes the vehicle to move slowly when the engine is running. Make sure the foot brake pedal is depressed fully and the vehicle is stopped before shifting the shift lever.

- **MAKE SURE OF THE SHIFT LEVER POSITION** - Make sure the shift lever is in the desired position. "D" (Drive) and "L" (Low) are used to move forward and "R" (Reverse) to back up.
- **WARM UP THE ENGINE** - Due to the higher idle speeds when the engine is cold, extra caution must be exercised when shifting the shift lever into the driving position immediately after starting the engine.

Shifting

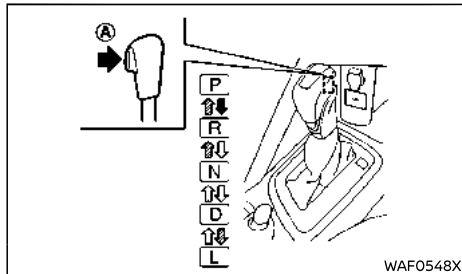

- ➔ Push the button A while depressing the foot brake pedal.
- ➔ Push the button A
- ➔ Just move the shift lever.

⚠ WARNING:

- Apply the parking brake if the shift lever is in any position while the engine is not running. Failure to do so could cause the vehicle to move unexpectedly or roll away and result in serious personal injury or property damage.
- If the shift lever cannot be moved from the "P" (Park) position while the engine is running and the foot brake pedal is depressed, the stop lights may not work. Malfunctioning stop lights could cause an accident injuring yourself and others.

After starting the engine, fully depress the foot brake pedal, push the shift lever button and move the shift lever out of the "P" (Park) position.

If the ignition switch is placed in the "OFF" position for any reason while the shift lever is in any positions other than the "P" (Park) position, the ignition switch cannot be placed in the "LOCK" position.

When it is hard to shift the shift lever from the "P" (Park) position to other position, first check that the parking brake is applied, then release the foot brake pedal and depress the foot brake pedal again.

If the ignition switch cannot be placed in the "LOCK" position, perform the following steps:

1. Apply the parking brake.
2. Place the ignition switch in the "ON" position while depressing the foot brake pedal.
3. Move the shift lever to the "P" (Park) position.
4. Place the ignition switch in the "LOCK" position.

P (Park):

Use this position when the vehicle is parked or when starting the engine. **Make sure that the vehicle is completely stopped and move the shift lever into the "P" (Park) position.** Apply the parking brake. When parking on a hill, first depress the foot brake pedal, apply the parking brake, and then move the shift lever into the "P" (Park) position.

R (Reverse):

Use this position to back up. Make sure that the vehicle is completely stopped before selecting the "R" (Reverse) position.

N (Neutral):

Neither the forward nor reverse gear is engaged. The engine can be started in this position. You may shift to the "N" (Neutral) position and restart a stalled engine while the vehicle is moving.

D (Drive):

Use this position for all normal forward driving.

L (Low):

Use this position when climbing steep hills slowly or driving slowly through deep snow, sand or mud, or for maximum engine braking on steep downhill grades.

SPORT mode switch (if equipped)

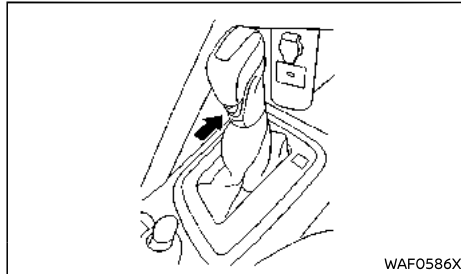

SPORT SPORT mode indicator

To select the SPORT mode, push the SPORT mode switch with the shift lever in the "D" (Drive) position. The SPORT mode indicator **SPORT** appears in the vehicle information display. To turn off the SPORT mode, push the SPORT mode switch again. The SPORT mode indicator will turn off. When the shift lever is shifted to any position other than "D" (Drive), the SPORT mode will be automatically turned off. However, the SPORT mode indicator is still displayed. When the shift lever is shifted to the "D" (Drive) position again, the SPORT mode will be activated again.

When the shift lever is not in the "D" (Drive) position and the SPORT mode switch is pushed, the SPORT mode indicator appears but the SPORT mode will not be activated. When the shift lever is shifted to the "D" (Drive) position, then the SPORT mode will be activated.

"OFF" position:

For normal driving and fuel economy, use the "OFF" position.

"ON" position:

For driving up or down long slopes where engine braking is necessary, or for powerful acceleration, use the "ON" position. The transmission will automatically select a different gear ratio, allowing the engine to provide high output.

When driving conditions change, push the switch to turn the SPORT mode off.

Remember not to drive at high speeds for extended periods of time with the SPORT mode in the "ON" position. This reduces fuel economy.

Accelerator downshift - in the "D" position -
For passing or climbing hills, depress the accelerator pedal to the floor. This shifts the transmission down into a lower gear, depending on the vehicle speed.

Shift lock release

If the battery is discharged, the shift lever may not be moved from the "P" (Park) position even with the foot brake pedal depressed.

To release the shift lock, perform the following procedure:

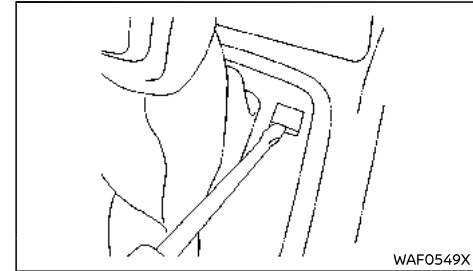

1. **Models with Intelligent Key system:**

Place the ignition switch in the "OFF" or "LOCK" position.

Models without Intelligent Key system:

Place the ignition switch in the "LOCK" position, and remove the key if it is inserted.

2. Apply the parking brake.
3. Remove the shift lock release cover using a suitable tool.
4. Insert a suitable tool and push down the shift lock release.
5. Push the shift lever button and move the shift lever to the "N" (Neutral) position while holding down the shift lock release. Replace the removed cover after the operation.

Place the ignition switch in the "ON" position to release the steering wheel lock.

The vehicle may be moved, by pushing, to the desired location.

If the shift lever cannot be moved out of the "P" (Park) position, have a NISSAN dealer check the CVT system as soon as possible.

High fluid temperature protection mode

This transmission has a high fluid temperature protection mode. If the fluid temperature becomes too high (for example, when climbing steep grades in high temperature with heavy loads), engine power and, under some conditions, vehicle speed will be decreased automatically to reduce the chance of transmission damage. Vehicle speed can be controlled with the accelerator pedal, but engine and vehicle speed may be limited.

Fail-safe

When the fail-safe operation occurs, the vehicle speed will be decreased automatically to reduce the risk of transmission damage. Vehicle speed can be controlled with the acceleration pedal, but the engine power may be limited. Have a NISSAN dealer or qualified workshop check and repair the transmission.

If the vehicle is driven under extreme conditions, such as excessive wheel spinning and subsequent hard braking, the fail-safe system may be activated. This will occur even if all electrical circuits are functioning properly. In this case, place the ignition switch in the "OFF" position and wait for 10 seconds. Then place the ignition switch back in the "ON" position. The vehicle should return to its normal operating condition. If it does not return to its normal operating condition, have a NISSAN dealer check the transmission and repair it if necessary.



WARNING:

When the fail-safe operation occurs, vehicle speed may be gradually reduced. The reduced speed may be lower than other traffic, which could increase the chance of a collision. Be especially careful when driving. If

necessary, pull to the side of the road at a safe place and allow the transmission to return to normal operation, or have it repaired if necessary.

DRIVING WITH MANUAL TRANSMISSION (MT)



WARNING:

- Do not downshift abruptly on slippery roads. This may cause a loss of vehicle control.
- Do not over-rev the engine when shifting to a lower gear. This may cause a loss of vehicle control or engine damage.



CAUTION:

- Do not shift quickly to avoid the cracking noise.
- Do not rest your foot on the clutch pedal while driving. This may damage the clutch system.
- Fully depress the clutch pedal before shifting to help prevent transmission damage.
- Stop the vehicle completely before shifting into the "R" (Reverse) position.
- When the vehicle is stopped for a period of time, for example waiting at stoplights, shift to the "N" (Neutral) position and release the clutch pedal with the foot brake pedal depressed.
- Do not shift to the "N" (Neutral) position while driving. Doing so may result in an accident due to loss of engine braking.

Starting vehicle

1. After starting the engine, depress the clutch pedal to the floor and move the shift lever to the "1" (1st) or "R" (Reverse) position.
2. Slowly depress the accelerator pedal, releasing the clutch pedal and parking brake at the same time.

Shifting gear

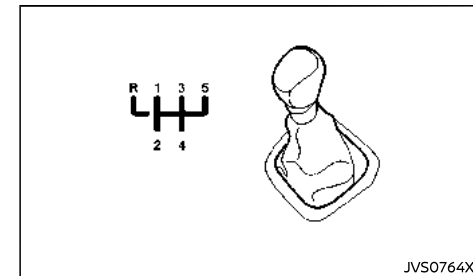

For BR10 HS engine model

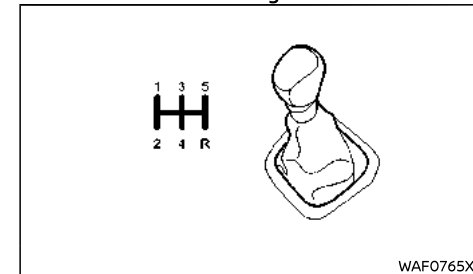

For HRA0DET engine model

To change gears, or when upshifting or downshifting, fully depress the clutch pedal, shift into the appropriate gear, then slowly and smoothly release the clutch pedal.

To ensure smooth gear changes, fully depress the clutch pedal before operating the shift lever. If the clutch pedal is not fully depressed before the transmission is shifted, a gear noise may be heard. Transmission damage could occur.

Start the vehicle in the "1" (1st) position and shift to the "2" (2nd), "3" (3rd), "4" (4th) and "5" (5th) gear in sequence according to the vehicle speed.

Shifting "R" (Reverse) position (HRAODET engine model):

To back up, stop the vehicle and move the shift lever into the "N" (Neutral) position, and then move the shift lever into the "R" (Reverse) position.

Shifting "R" (Reverse) position (BR10 HS engine model):

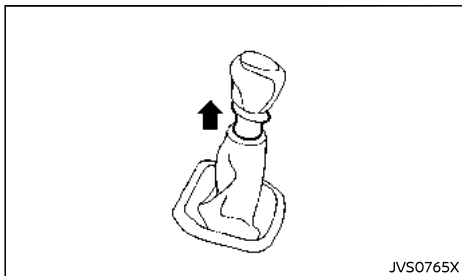

To back up, stop the vehicle and move the shift lever into the "N" (Neutral) position, and then pull the ring upward to shift into the "R" (Reverse) position. The ring returns to its original position when the shift lever is moved to the "N" (Neutral) position.

If it is difficult to move the shift lever into the "R" (Reverse) or "1" (1st) position, shift to the "N"

(Neutral) position, and then release the clutch pedal once. Fully depress the clutch pedal again and shift into "R" or "1".

Gear shift indicator (if equipped)

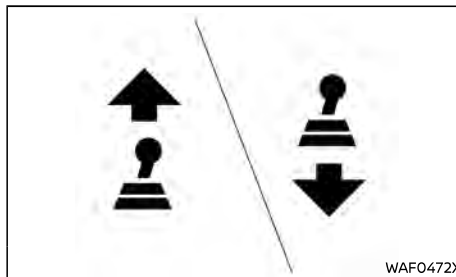

Example

The manual transmission gear shift indicator appears in the meter when the driver should shift into a higher or lower gear as indicated by the up or down arrow. The use of the gear shift indicator will help the driver to upshift or downshift at a constant engine speed from any gear according to the preferred operation or road condition.

When the up arrow appears, upshifting is recommended. When the down arrow appears, downshifting is recommended.

Suggested maximum speed in each gear

Downshift to a lower gear if the engine is not running smoothly, or if you need to accelerate.

Do not exceed the maximum suggested speed (shown below) in any gear. For level road driving, use the highest gear suggested for that speed. Always observe posted speed limits, and drive according to the road conditions which will ensure safe operation. Do not over-rev the engine when shifting to a lower gear as

it may cause engine damage or loss of vehicle control.

BR10 HS engine model:

	km/h (MPH)
1st	37.8 (23.5)
2nd	68.3 (42.4)
3rd	111.0 (69.0)
4th	— (—)
5th	— (—)





HRAODET engine model:

	km/h (MPH)
1st	46.0 (28.6)
2nd	88.0 (54.7)
3rd	140.0 (87.0)
4th	— (—)
5th	— (—)

VEHICLE DYNAMIC CONTROL (VDC) SYSTEM (if equipped)



WARNING:

- The Vehicle Dynamic Control (VDC) system is designed to help the driver maintain stability but does not prevent accidents due to abrupt steering operation at high speeds or by careless or dangerous driving techniques. Reduce vehicle speed and be especially careful when driving and cornering on slippery surfaces and always drive carefully.
- Do not modify the vehicle's suspension. If suspension parts such as shock absorbers, struts, springs, stabilizer bars, bushings and wheels are not NISSAN recommended for your vehicle or are extremely deteriorated, the VDC system may not operate properly. This could adversely affect vehicle handling performance, and the VDC warning light  may illuminate.
- If brake related parts such as brake pads, rotors and calipers are not NISSAN recommended or are extremely deteriorated, the VDC system may not operate properly and the VDC warning light  may illuminate.
- If engine control related parts are not NISSAN recommended or are extremely deteriorated, the VDC warning light  may illuminate.
- When driving on extremely inclined surfaces such as higher banked corners, the VDC system may not operate properly and the VDC warning light  may illuminate. Do not drive on these types of roads.
- When driving on an unstable surface such as a turntable, ferry, elevator or ramp, the

VDC warning light  may illuminate. This is not a malfunction. Restart the engine after driving onto a stable surface.

- If wheels or tires other than the NISSAN recommended ones are used, the VDC system may not operate properly and the VDC warning light  may illuminate.
- The VDC system is not a substitute for winter tires or tire chains on a snow covered road.

The Vehicle Dynamic Control (VDC) system uses various sensors to monitor driver inputs and vehicle motion. Under certain driving conditions, the VDC system helps to perform the following functions.

- Controls brake pressure to reduce wheel slip on one slipping drive wheel so power is transferred to a non slipping drive wheel on the same axle.
- Controls brake pressure and engine output to reduce drive wheel slip based on vehicle speed (traction control function).
- Controls brake pressure at individual wheels and engine output to help the driver maintain control of the vehicle in the following conditions:
 - understeer (vehicle tends to not follow the steered path despite increased steering input)
 - oversteer (vehicle tends to spin due to certain road or driving conditions).

The VDC system can help the driver to maintain control of the vehicle, but it cannot prevent loss of vehicle control in all driving situations.

When the VDC system operates, the VDC warning light  in the instrument panel flashes so note the following:

- The road may be slippery or the system may determine some action is required to help the vehicle on the steered path.
- You may feel a pulsation in the brake pedal and hear a noise or vibration from under the hood. This is normal and indicates that the VDC system is working properly.
- Adjust your speed and driving to the road conditions.

If a malfunction occurs in the system, the VDC warning light  illuminates in the instrument panel. The VDC system automatically turns off. See "Vehicle Dynamic Control (VDC) warning light" (P.2-13).

The computer has a built-in diagnostic feature that tests the system each time you start the engine and move the vehicle forward or in reverse at a slow speed. When the self-test occurs, you may hear a "clunk" noise and/or feel a pulsation in the brake pedal. This is normal and is not an indication of a malfunction.

VEHICLE DYNAMIC CONTROL (VDC) OFF SWITCH (if equipped)

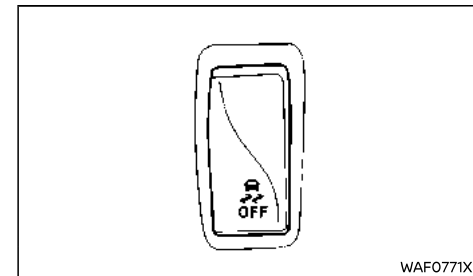

The vehicle should be driven with the Vehicle Dynamic Control (VDC) system ON for most

driving conditions.

When the vehicle is stuck in mud or snow, the VDC system reduces the engine output to reduce wheel spin. The engine speed will be reduced even if the accelerator is depressed to the floor. If maximum engine power is needed to free a stuck vehicle, turn the VDC system off.

To turn off the VDC system, push the lower side of the VDC OFF switch. The  indicator light will illuminate.

Push the upper side of the VDC OFF switch or restart the engine to turn ON the system.

HILL START ASSIST SYSTEM (if equipped)



WARNING:

- **Never rely solely on the hill start assist system to prevent the vehicle from moving backward on a hill. Always drive carefully and attentively. Depress the brake pedal when the vehicle is stopped on a steep hill. Be especially careful when stopped on a hill on frozen or muddy roads. Failure to prevent the vehicle from rolling backwards may result in a loss of control of the vehicle and possible serious injury or death.**
- **The hill start assist system is not designed to hold the vehicle at a standstill on a hill. Depress the brake pedal when the vehicle is stopped on a steep hill. Failure to do so may cause the vehicle to roll backwards and may result in a collision or serious personal injury.**
- **The hill start assist system may not prevent the vehicle from rolling backwards on a hill under all load or road conditions. Always be prepared to depress the brake pedal to prevent the vehicle from rolling backwards. Failure to do so may result in a collision or serious personal injury.**

The hill start assist system automatically keeps the brakes applied to help prevent the vehicle from rolling backwards in the time it takes the driver to release the brake pedal and apply the accelerator when the vehicle is stopped on a hill.

The hill start assist system will operate automatically under the following conditions:

- The transmission is shifted to a forward or reverse gear.

- The vehicle is stopped completely on a hill by applying the brake.

The maximum holding time is 2 seconds. After 2 seconds the vehicle will begin to roll back and the hill start assist system will stop operating completely.

The hill start assist system will not operate when the transmission is shifted to the "N" (Neutral) (for MT model) or "P" (Park) position (for CVT model), or on a flat and level road.

When the Vehicle Dynamic Control (VDC) warning light illuminates in the meter, the hill start assist system will not operate. (See "Vehicle Dynamic Control (VDC) system" (P.5-15).)

CRUISE CONTROL (if equipped)

WARNING:

- Always observe the posted speed limits and do not set the speed over them.
- Do not use the cruise control when driving under the following conditions. Doing so could cause a loss of vehicle control and result in an accident.
 - When it is not possible to keep the vehicle at a constant speed
 - When driving in heavy traffic
 - When driving in traffic that varies speed
 - When driving in windy areas
 - When driving on winding or hilly roads
 - When driving on slippery (rain, snow, ice, etc.) roads

CAUTION:

On Manual Transmission (MT) model, do not shift to the "N" (Neutral) position without depressing the clutch pedal when the cruise control is operated. Should this occur, depress the clutch pedal and turn the cruise control MAIN switch off immediately. Failure to do so may cause engine damage.

PRECAUTIONS ON CRUISE CONTROL

- If the cruise control system malfunctions, it cancels automatically. The set speed indicator and the cruise control indicator will blink to warn the driver.
- If the set speed indicator and cruise control indicator blink, turn off the cruise control MAIN switch and have the system checked by a NISSAN dealer.
- The set speed indicator and cruise control indicator may blink when the cruise control MAIN switch is turned on while pushing the RES+ switch. To properly set the cruise control system, use the following procedures.

CRUISE CONTROL OPERATIONS

The cruise control allows driving at speeds above 30 km/h (19 MPH) (BR10 HS engine model) or 40 km/h (25 MPH) (HRA0DET engine model) without keeping your foot on the accelerator pedal.

Depressing the clutch pedal (for Manual Transmission (MT) vehicle) will cancel the cruise control and the set speed indicator will turn off.

The cruise control switches are located on the steering wheel and the right side of the instrument panel.

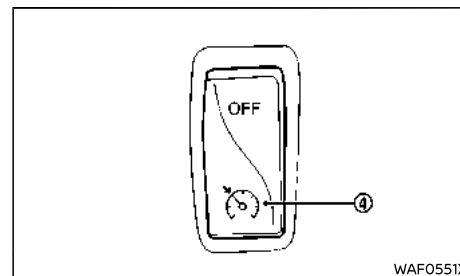
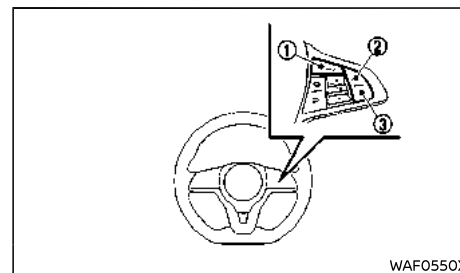

- ① Cruise control CANCEL switch
- ② RES+ switch
- ③ - switch
- ④ Cruise control MAIN switch

Turning ON cruise control

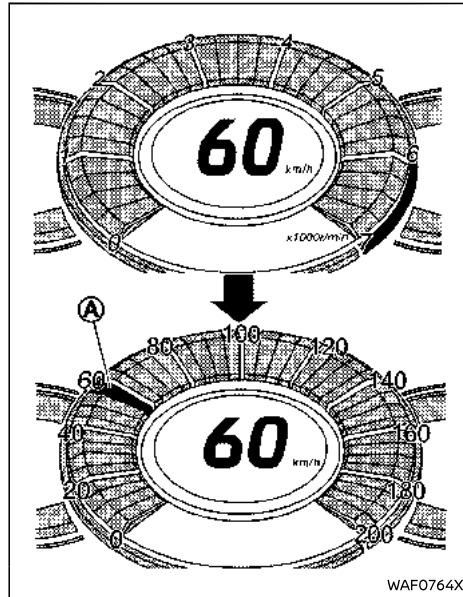

Cruise control indicator

Push the cruise control MAIN switch ④ and cruise control indicator will be displayed on the speedometer.

Vehicle speed should be accelerated above 30 km/h (19 MPH) (BR10 HS engine model) or 40 km/h (25 MPH) (HRAODET engine model) and pressing the - switch ③ will navigate the display from the tachometer display to the speedometer display in the meter cluster with actual cruise speed set (A) (set speed indicator).

Pressing the RES+ switch ② will increase from current set speed and pressing the cruise control CANCEL switch ① will cancel the cruise speed. Pressing again the RES+ switch ② will set to the previous cruise speed as it will be in the memorized speed.

Setting cruising speed

1. Accelerate to the desired speed.
2. Push the - switch ③ and release it.
3. The set speed is displayed in the vehicle information display.
4. Take your foot off the accelerator pedal.

The vehicle will maintain the set speed.

Passing another vehicle:

Depress the accelerator pedal to accelerate. If the vehicle speed overrides the cruise control set speed, the cruise control set speed on the vehicle information display blinks. After releasing the accelerator pedal, the vehicle will return to the previously set speed.

The vehicle may not maintain the set speed when going up or down steep hills. In such cases, drive without the cruise control.

Resetting to slower speed:

Use any one of the following methods to reset to a slower speed.

- Lightly tap the foot brake pedal. When the vehicle reaches the desired speed, push and release the - switch ③.
- Keep the - switch ③ pressed till the vehicle reaches the desired speed and then release the - switch ③.

Resetting to faster speed:

Use any one of the following methods to reset to a faster speed.

- Depress the accelerator pedal to reach the desired speed. To set the desired speed as set point speed, hold the pedal and then press RES+ switch ② or - switch ③. After the cruise control set speed in the display changes to the new speed, release the accelerator pedal.
- Keep the RES+ switch ② pressed till the vehicle reaches the desired speed and then release the RES+ switch ②.

Resuming at preset speed:

Push and release the RES+ switch ②.

The vehicle will resume the last set cruising speed when the vehicle speed is over 30 km/h (19 MPH) (BR10 HS engine model) or 40 km/h (25 MPH) (HRAODET engine model).

Canceling cruising speed

Driver can come out of cruise control by any of the following options:

- Press the cruise control CANCEL switch ①.
- Press the brake pedal.
- Press the clutch pedal (for Manual Transmission (MT) vehicle).

FUEL EFFICIENCY AND CARBON DIOXIDE REDUCTION DRIVING TIPS

- Shift change by pressing the clutch pedal (for MT vehicle).

In all the above cases, the vehicle information display will change to "Memorised speed" (displaying the last cruising speed).

To resume the stored set speed, push the RES+ switch.

To cancel the cruise control, push the cruise control MAIN switch to OFF. The cruise control indicator will turn off. This canceling method will erase the set cruise control memory.

Follow these easy-to-use Fuel Efficiency and Carbon Dioxide Reduction Driving Tips to help you achieve the most fuel economy from your vehicle and reduce carbon dioxide emissions.

1. Use smooth accelerator and brake pedal application.
 - Avoid rapid starts and stops.
 - Use smooth, gentle accelerator and brake application whenever possible.
 - Maintain constant speed while commuting and coast whenever possible.
2. Maintain constant speed.
 - Look ahead to try and anticipate and minimize stops.
 - Synchronizing your speed with traffic lights allows you to reduce your number of stops.
 - Maintaining a steady speed can minimize red light stops and improve fuel efficiency.
3. Drive at economical speeds and distances.
 - Observing the speed limit and not exceeding 97 km/h (60 MPH) (where legally allowed) can improve fuel efficiency due to reduced aerodynamic drag.
 - Maintaining a safe following distance behind other vehicles reduces unnecessary braking.
 - Safely monitoring traffic to anticipate changes in speed permits reduced braking and smooth acceleration changes.
 - Select a gear range suitable to road conditions.
4. Use cruise control (if equipped).
 - Using cruise control during highway driving helps maintain a steady speed.
5. Plan for the shortest route.
 - Utilize a map or navigation system (if equipped) to determine the best route to save time.
6. Avoid idling.
 - Shutting off your engine when safe for stops exceeding 30-60 seconds saves fuel and reduces emissions.
7. Buy an automated pass for toll roads.
 - Automated passes permit drivers to use special lanes to maintain cruising speed through the toll and avoid stopping and starting.
8. Winter warm up.
 - Limit idling time to minimize impact to fuel economy.
 - Vehicles typically need no more than 30 seconds of idling at start-up to effectively circulate the engine oil before driving.
 - Your vehicle will reach its ideal operating temperature more quickly while driving versus idling.
9. Keeping your vehicle cool.
 - Park your vehicle in a covered parking area or in the shade whenever possible.
 - When entering a hot vehicle, opening the windows will help to reduce the inside temperature faster, resulting in reduced demand on your A/C system.
10. Do not carry excessive weight.
 - Remove unnecessary objects from the vehicle to reduce vehicle weight.

INCREASING FUEL ECONOMY AND REDUCING CARBON DIOXIDE EMISSIONS

- Keep your engine tuned up.
- Follow the recommended scheduled maintenance.
- Keep the tires inflated to the correct pressure. Low tire pressure increases tire wear and lowers fuel economy.
- Keep the wheels in correct alignment. Improper alignment increases tire wear and lowers fuel economy.
- Use the recommended viscosity engine oil. (See "Recommended fluids/lubricants and capacities" (P.9-2).)

PARKING



WARNING:

- **Do not stop or park the vehicle over flammable materials such as dry grass, waste paper or rags. They may ignite and cause a fire.**
- **Safe parking procedures require that both the parking brake be applied and the shift lever placed in the "P" (Park) position (Continuously Variable Transmission (CVT) model) or the shift lever placed in an appropriate gear (Manual Transmission (MT) model). Failure to do so could cause the vehicle to move unexpectedly or roll away and result in an accident.**
- **When parking the vehicle, make sure the shift lever is moved to the "P" (Park) position. The shift lever cannot be moved out of the "P" (Park) position without depressing the foot brake pedal (CVT model).**
- **Never leave the engine running while the vehicle is unattended.**
- **Do not leave children unattended inside the vehicle. They could unknowingly activate switches or controls. Unattended children could become involved in serious accidents.**
- **To help avoid risk of injury or death through unintended operation of the vehicle and/or its systems, do not leave children, people who require the assistance of others or pets unattended in your vehicle. Additionally, the temperature inside a closed vehicle on a warm day can quickly become high enough to cause a significant risk of injury or death to people and pets.**

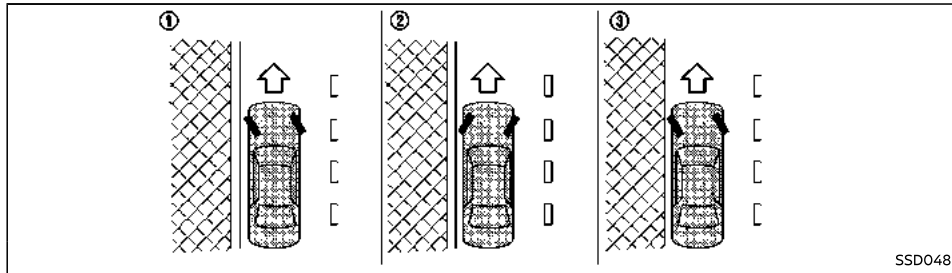

SSD0489

1. Firmly apply the parking brake.
2. Move the shift lever to the "P" (Park) position (CVT model) or "R" (Reverse) position (MT model). When parking on an uphill grade, move the shift lever to the "1" (1st) position.
3. To help prevent the vehicle from moving into traffic when parked on an incline, it is a good practice to turn the wheels as illustrated.
4. **Model with Intelligent Key system:**
Place the ignition switch to stop the engine.
Model without Intelligent Key system:
Place the ignition switch in the "LOCK" position and remove the key.

HEADED DOWNHILL WITH CURB ①

Turn the wheels towards the curb and move the vehicle forward until the curb side wheel gently touches the curb. Then apply the parking brake.

HEADED UPHILL WITH CURB ②

Turn the wheels away from the curb and allow the vehicle to move back until the curb side wheel gently touches the curb. Then apply the parking brake.

HEADED UPHILL OR DOWNHILL, WITHOUT CURB ③

Turn the wheels toward the side of the road so the vehicle will move away from the center of the road if the vehicle moves. Then apply the parking brake.

PARKING SENSOR (sonar) SYSTEM

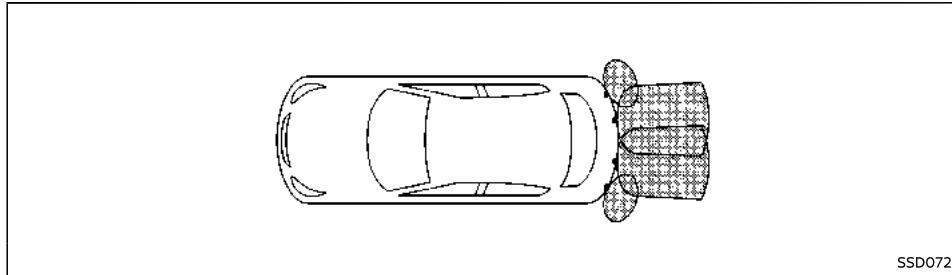

Keep the sonar sensors (located on the bumper fascia) free from snow, ice and large accumulations of dirt (do not clean the sensors with sharp objects). If the sensors are covered, it will affect the accuracy of the parking sensor (sonar) system.

If the parking sensor (sonar) system malfunctions, the beep sounds for 3 seconds when the shift lever is moved to the "R" (Reverse) position. Have the system checked by a NISSAN dealer.



WARNING:

- The parking sensor (sonar) system is a convenience but it is not a substitute for proper parking. Always look around and check that it is safe to do so before parking. Always move slowly.
- Read and understand the limitations of the parking sensor (sonar) system as contained in this section. Inclement weather may affect the function of the parking sensor (sonar) system; this may include reduced performance or a false activation.
- This system is not designed to prevent contact with small or moving objects.
- The system is designed as an aid to the driver in detecting large stationary objects to help avoid damaging the vehicle. The system will not detect small objects below the bumper, and may not detect objects close to the bumper or on the ground.
- If your vehicle sustains damage to the bumper fascia, leaving it misaligned or bent, the sensing zone may be altered

causing inaccurate measurement of obstacles or false alarms.



CAUTION:

Keep the interior of the vehicle as quiet as possible to hear the tone clearly.

When the ignition switch is in the "ON" position, the parking sensor (sonar) system is operational.

The parking sensor (sonar) system sounds a tone to warn the driver of obstacles near the bumper. The system detects rear obstacles when the shift lever is in the "R" (Reverse) position. The system may not detect objects at speeds above 10 km/h (6 MPH) and may not detect certain angular or moving objects.

The parking sensor (sonar) system detects obstacles up to 1.2 m (3.9 ft) from the bumper with a decreased coverage area at the outer corners of the bumper (refer to the illustration for approximate zone coverage areas). As you move closer to the obstacle, the rate of the tone increases. When the obstacle is less than 40 cm (15.7 in) away, the tone will sound continuously.

TRAILER TOWING

Your vehicle was designed to be used to carry passengers and luggage. NISSAN does not recommend trailer towing, because it places additional loads on your vehicle's engine, drive-train, steering, braking and other systems.



CAUTION:

Vehicle damage resulting from towing a trailer is not covered by the warranty.

ELECTRIC POWER STEERING



WARNING:

- **If the engine is not running or is turned off while driving, the power assist for the steering will not work. Steering will be harder to operate.**
- **When the electric power steering warning light illuminates with the engine running, the power assist for the steering will cease operation. You will still have control of the vehicle, but the steering will be much harder to operate.**

The electric power steering is designed to provide power assist while driving to operate the steering wheel with light force.

When the steering wheel is operated repeatedly or continuously while parking or driving at a very low speed, the power assist for the steering wheel will be reduced. This is to prevent overheating of the electric power steering and protect it from getting damaged. While the power assist is reduced, steering wheel operation will become heavy. When the temperature of the electric power steering goes down, the power assist level will return to normal. Avoid repeating such steering wheel operations that could cause the electric power steering to overheat.

You may hear a fricative sound when the steering wheel is operated quickly. However, this is not a malfunction. If the electric power steering warning light illuminates while the engine is running, it may indicate the electric power steering is not functioning properly and may need servicing. Have the electric power steering checked by a NISSAN dealer. (See "Electric power steering warning light" (P.2-11).)

When the electric power steering warning light illuminates with the engine running, the power

assist for the steering will cease operation. You will still have control of the vehicle. However, greater steering effort is needed, especially in sharp turns and at low speeds.

BRAKE SYSTEM

The brake system has two separate hydraulic circuits. If one circuit malfunctions, you will still have braking ability at two wheels.

BRAKE PRECAUTIONS

Vacuum assisted brakes

The brake booster aids braking by using engine vacuum. If the engine stops, you can stop the vehicle by depressing the foot brake pedal. However, greater foot pressure on the foot brake pedal will be required to stop the vehicle. The stopping distance will be longer.

If the engine is not running or is turned off while driving, the power assisted brakes will not function. Braking will be harder.



WARNING:

Do not coast with the engine stopped.

When the brake pedal is depressed slowly and firmly, you may hear a clicking noise and feel a slight pulsation. This is normal and indicates that the Brake Assist System is operating.

Using brakes

Avoid resting your foot on the foot brake pedal while driving. This will overheat the brakes, wear out the brake linings/pads faster, and increase fuel consumption.

To help reduce brake wear and to prevent the brakes from overheating, reduce speed and downshift to a lower gear before going down a slope or long grade. Overheated brakes may reduce braking performance and could result in loss of vehicle control.

While driving on a slippery surface, be careful when braking, accelerating or downshifting. Abrupt braking or acceleration could cause the wheels to skid and result in an accident.

5-24 Starting and driving

Wet brakes

When the vehicle is washed or driven through water, the brakes may get wet. As a result, your braking distance will be longer and the vehicle may pull to one side during braking.

To dry the brakes, drive the vehicle at a safe speed while lightly depressing the foot brake pedal to heat up the brakes. Do this until the brakes return to normal. Avoid driving the vehicle at high speeds until the brakes function correctly.

Parking brake break-in

Break in the parking brake shoes whenever the stopping effect of the parking brake is weakened or whenever the parking brake shoes and/or drums/rotors are replaced, in order to assure the best braking performance.

This procedure is described in the vehicle service manual and can be performed by a NISSAN dealer.

Driving uphill

When starting on a steep grade, it is sometimes difficult to operate both the brake and clutch (for MT model). Apply the parking brake to hold the vehicle. Do not slip the clutch. When ready to start, slowly release the parking brake while depressing the accelerator pedal and releasing the clutch pedal.

Driving downhill

The engine braking action is effective for controlling the vehicle while descending hills. For Manual Transmission (MT) model, the shift lever should be placed in the lower speed gear prior to descending. For Continuously Variable Transmission (CVT) model, the "L" (Low) position should be selected.

BRAKE ASSIST

When the force applied to the brake pedal exceeds a certain level, the Brake Assist is activated generating greater braking force than a conventional brake booster even with light pedal force.



WARNING:

The Brake Assist is only an aid to assist braking operation and is not a collision warning or avoidance device. It is the driver's responsibility to stay alert, drive safely and be in control of the vehicle at all times.

ANTI-LOCK BRAKING SYSTEM (ABS)



WARNING:

- **The Anti-lock Braking System (ABS) is a sophisticated device, but it cannot prevent accidents resulting from careless or dangerous driving techniques. It can help maintain vehicle control during braking on slippery surfaces. Remember that stopping distances on slippery surfaces will be longer than on normal surfaces even with ABS. Stopping distances may also be longer on rough, gravel or snow covered roads, or if you are using tire chains. Always maintain a safe distance from the vehicle in front of you. Ultimately, the driver is responsible for safety.**
- **Tire type and condition may also affect braking effectiveness.**
 - **When replacing tires, install the specified size of tires on all four wheels.**

- **When installing a spare tire, make sure that it is the proper size and type as specified on the tire placard. (See “Tire placard” (P.9-8).)**
- **For detailed information, see “Tires and wheels” (P.8-28).**

The Anti-lock Braking System (ABS) controls the brakes so the wheels do not lock during hard braking or when braking on slippery surfaces. The system detects the rotation speed at each wheel and varies the brake fluid pressure to prevent each wheel from locking and sliding. By preventing each wheel from locking, the system helps the driver maintain steering control and helps to minimize swerving and spinning on slippery surfaces.

Using system

Depress the brake pedal and hold it down. Depress the brake pedal with firm steady pressure, but do not pump the brakes. The ABS will operate to prevent the wheels from locking up. Steer the vehicle to avoid obstacles.



WARNING:

Do not pump the brake pedal. Doing so may result in increased stopping distances.

Self-test feature

The ABS includes electronic sensors, electric pumps, hydraulic solenoids and a computer. The computer has a built-in diagnostic feature that tests the system each time you start the engine and move the vehicle at a low speed in forward or reverse. When the self-test occurs, you may hear a “clunk” noise and/or feel a pulsation in the brake pedal. This is normal and does not indicate a malfunction. If the computer senses a malfunction, it switches the ABS

off and illuminates the ABS warning light on the instrument panel. The brake system then operates normally, but without anti-lock assistance.

If the ABS warning light illuminates during the self-test or while driving, have the vehicle checked by a NISSAN dealer.

Normal operation

The ABS operates at speeds above 5 to 10 km/h (3 to 6 MPH). The speed varies according to road conditions.

When the ABS senses that one or more wheels are close to locking up, the actuator rapidly applies and releases hydraulic pressure. This action is similar to pumping the brakes very quickly. You may feel a pulsation in the brake pedal and hear a noise from under the hood or feel a vibration from the actuator when it is operating. This is normal and indicates that the ABS is operating properly. However, the pulsation may indicate that road conditions are hazardous and extra care is required while driving.

VEHICLE SECURITY

When leaving your vehicle unoccupied:

- Always take the key with you - even when leaving the vehicle in your own garage.
- Close all windows completely and lock all doors.
- Always park your vehicle where it can be seen. Park in a well lit area during the night.
- If the security system is equipped, use it - even for a short period.
- Never leave children or pets in the vehicle unattended.
- Never leave valuables inside the vehicle. Always take valuables with you.
- Never leave the vehicle documents in the vehicle.
- Never leave articles on a roof rack. Remove them from the rack and keep and lock them inside the vehicle.
- Never leave the spare key in the vehicle.

COLD WEATHER DRIVING



WARNING:

- **Whatever the condition, drive with caution. Accelerate and decelerate with great care. If accelerating or decelerating too fast, the drive wheels will lose even more traction.**
- **Allow more stopping distance in cold weather driving. Braking should be started sooner than on dry pavement.**
- **Keep at a greater distance from the vehicle in front of you on slippery roads.**
- **Wet ice (0°C, 32°F and freezing rain), very cold snow and ice can be slick and very difficult to drive on. The vehicle will have a lot less traction or grip under these conditions. Try to avoid driving on wet ice until the road is salted or sanded.**
- **Watch for slippery spots (glaring ice). These may appear on an otherwise clear road in shaded areas. If a patch of ice is seen ahead, brake before reaching it. Try not to brake while actually on the ice, and avoid any sudden steering maneuvers.**
- **Do not use cruise control (if equipped) on slippery roads.**
- **Snow can trap dangerous exhaust gas under your vehicle. Keep snow clear of the exhaust pipe and from around your vehicle.**

BATTERY

If the battery is not fully charged during extremely cold weather conditions, the battery fluid may freeze and damage the battery. To maintain maximum efficiency, the battery should be checked regularly. For details, see "Battery" (P.8-17).

ENGINE COOLANT

If the vehicle is to be left outside without anti-freeze, drain the cooling system, including the engine block. Refill before operating the vehicle. For details, see "Changing engine coolant" (P.8-7).

TIRE EQUIPMENT

1. If you have snow tires installed on the front/rear wheels of your vehicle, they should be of the same size, loading range, construction and type (bias, bias-belted or radial) as the rear/front tires.
2. If the vehicle is to be operated in severe winter conditions, snow tires should be installed on all four wheels.
3. For additional traction on icy roads, studded tires may be used. However, some countries, provinces and states prohibit their use. Check local, state and provincial laws before installing studded tires.
Skid and traction capabilities of studded snow tires, on wet or dry surfaces, may be poorer than that of non-studded snow tires.
4. Snow chains may be used if desired. Make sure they are the proper size for the tires on your vehicle and are installed according to the chain manufacturer's instructions. Use chain tensioners when recommended by the tire chain manufacturer to ensure a

tight fit. Loose end links of the tire chains must be secured or removed to prevent the possibility of whipping action damage to the fenders or underbody. In addition, drive at a reduced speed, otherwise, your vehicle may be damaged and/or vehicle handling and performance may be adversely affected.

SPECIAL WINTER EQUIPMENT

It is recommended that the following items be carried in the vehicle during the winter:

- A scraper and stiff-bristled brush to remove ice and snow from the windows.
- A sturdy, flat board to be placed under the jack to give it firm support.
- A shovel to dig the vehicle out of snow-drifts.

PARKING BRAKE

When parking in the area where the outside temperature is below 0°C (32°F), do not apply the parking brake, if applied, may freeze in place and may be difficult to release.

For safe parking:

- Place the shift lever in the "P" (Park) position (for Continuously Variable Transmission (CVT) model).
- Place the shift lever in the "1" (1st) or "R" (Reverse) gear (for Manual Transmission (MT) model).
- Securely block the wheels.

CORROSION PROTECTION

Chemicals used for road surface deicing are extremely corrosive and will accelerate corrosion and the deterioration of underbody components such as the exhaust system, fuel and brake lines, brake cables, floor pan and fenders.

In the winter, the underbody must be cleaned periodically. For additional information, see "Corrosion protection" (P.7-5).

For additional protection against rust and corrosion, which may be required in some areas, consult a NISSAN dealer.

MEMO

6 In case of emergency

Hazard indicator flasher switch	6-2	Installing spare tire	6-5
Emergency Stop Signal	6-2	Stowing damaged tire and tools	6-6
Flat tire	6-2	Jump starting	6-7
Tire Pressure Monitoring System (TPMS)		Push starting	6-8
(if equipped)	6-2	If your vehicle overheats	6-8
Stopping vehicle	6-3	Towing your vehicle	6-9
Preparing tools and spare tire	6-3	Towing precautions	6-9
Blocking wheels	6-3	Towing recommended by NISSAN	6-10
Removing tire	6-4		

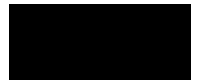

HAZARD INDICATOR FLASHER SWITCH

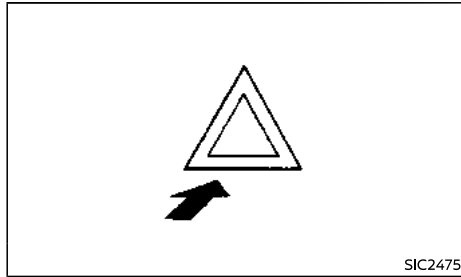

The hazard indicator flasher switch operates regardless of the ignition switch position except when the battery is discharged.

The hazard indicator flasher is used to warn other drivers when you have to stop or park under emergency conditions.

When the hazard indicator flasher switch is pushed, all turn signal lights will flash. To turn off the hazard indicator flasher, push the hazard indicator flasher switch again.

When an impact that could activate the supplemental air bags is detected, the hazard warning flasher lights blink automatically. If the hazard warning flasher switch is pushed, the hazard warning flashers will turn off.



WARNING:

Do not turn the hazard warning flasher switch to off until you can make sure that it is safe to do so. Also, the hazard flasher warning may not blink automatically depending on the force of impact.

EMERGENCY STOP SIGNAL

The Emergency Stop Signal will blink the hazard indicator flasher to prevent the rear-end collision, when a sudden braking operation is detected.

If an emergency brake occurs, then the hazard indicator flasher blinks quickly.

When the hazard indicator flasher switch is pushed during this emergency stop signal period, then the hazard indicator flasher blinks at the normal speed.

To stop the hazard indicator flasher, push the hazard indicator flasher switch again.

FLAT TIRE

If you have a flat tire, follow the instructions as follows.

TIRE PRESSURE MONITORING SYSTEM (TPMS) (if equipped)



WARNING:

- **If the low tire pressure warning light illuminates while driving, avoid sudden steering maneuvers or abrupt braking, reduce vehicle speed, pull off the road to a safe location and stop the vehicle as soon as possible. Driving with under-inflated tires may permanently damage the tires and increase the likelihood of tire failure. Serious vehicle damage could occur and may lead to an accident and could result in serious personal injury. Check the tire pressure for all four tires. Adjust the tire pressure to the recommended COLD tire pressure shown on the tire placard to turn the low tire pressure warning light OFF. If the light still illuminates while driving after adjusting the tire pressure, a tire may be flat or the TPMS may be malfunctioning. If you have a flat tire, replace it with a spare tire as soon as possible. If no tire is flat and all tires are properly inflated, have the vehicle checked by a NISSAN dealer.**
- **Since the spare tire is not equipped with the TPMS, when a spare tire is mounted or a wheel is replaced, the TPMS will not function and the low tire pressure warning light will flash for approximately 1 minute. The light will remain on after 1 minute. Contact a NISSAN dealer as soon as possible for tire replacement.**

- **Replacing tires with those not originally specified by NISSAN could affect the proper operation of the TPMS.**
- **Do not inject any tire liquid or aerosol tire sealant into the tires, as this may cause a malfunction of the tire pressure sensors.**

The Tire Pressure Monitoring System (TPMS) monitors tire pressure of all tires except the spare. When the low tire pressure warning light is lit and the tire pressure low telltale (if equipped) appears in the vehicle information display, one or more of your tires is significantly under-inflated. If the vehicle is being driven with low tire pressure, the TPMS will activate and warn you of it by the low tire pressure warning light (in the meter panel). This system will activate only when the vehicle is driven at speeds above 25 km/h (16 MPH).

For more details about the TPMS, see "Tire Pressure Monitoring System (TPMS)" (P.5-3).

For additional information, see "Low tire pressure warning light" (P.2-11).

STOPPING VEHICLE

WARNING:

- **Be sure to apply the parking brake firmly.**
- **Be sure to move the shift lever to the "P" (Park) position (Continuously Variable Transmission (CVT) model) or the shift lever to the "R" (Reverse) position (Manual Transmission (MT) model).**
- **Never change tires when the vehicle is on a slope, ice or slippery area. This is hazardous.**
- **Never change tires when the oncoming traffic is close to your vehicle. Call for professional road assistance.**

1. Safely move the vehicle off the road away from traffic.
2. Turn on the hazard indicator flasher lights.
3. Park on a level surface.
4. Apply the parking brake.
5. Continuously Variable Transmission (CVT) model: Move the shift lever to the "P" (Park) position.
Manual Transmission (MT) model: Move the shift lever to the "R" (Reverse) position.
6. Turn off the engine.
7. Open the hood:
 - To warn other traffic.
 - To signal professional road assistance personnel that you need assistance.
8. Have all passengers get out from the vehicle and stand in a safe place, away from other traffic and clear of the vehicle.

PREPARING TOOLS AND SPARE TIRE

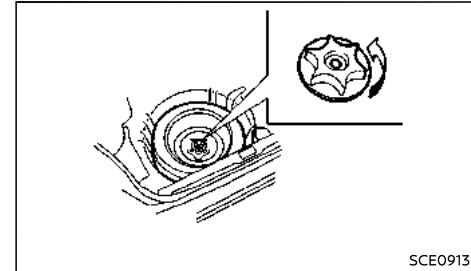
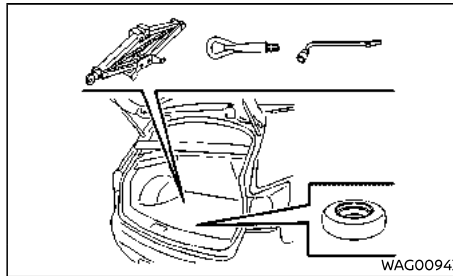

Remove the jack, necessary tools and the spare tire from the storage area.

The spare tire, jack and tools are located under the luggage floorboard.

Remove the luggage floorboard from the holding feature and take out the jack and tools from the storage area.

Remove the clamp holding the spare tire.

BLOCKING WHEELS

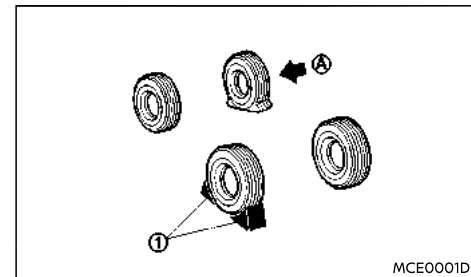



WARNING:

Be sure to block the appropriate wheel to prevent the vehicle from moving, which may cause personal injury.

Place suitable blocks ① at both the front and back of the wheel diagonally opposite the flat tire ② to prevent the vehicle from moving when it is jacked up.

REMOVING TIRE

Removing wheel cover (if equipped)

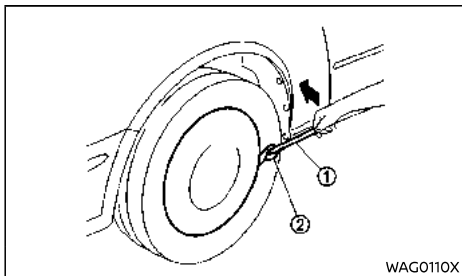

WARNING:

Never use your hands to remove the wheel cover. This may cause personal injury.

To remove the wheel cover, use a suitable tool ① as illustrated.

Apply cloth ② between the wheel and tool to prevent damaging the wheel and wheel cover.

Jacking up vehicle

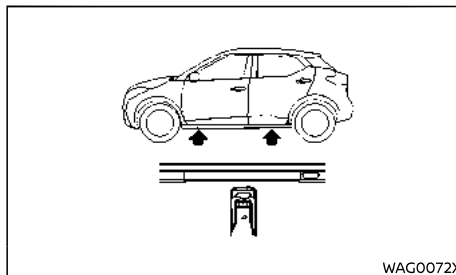

Jack-up points

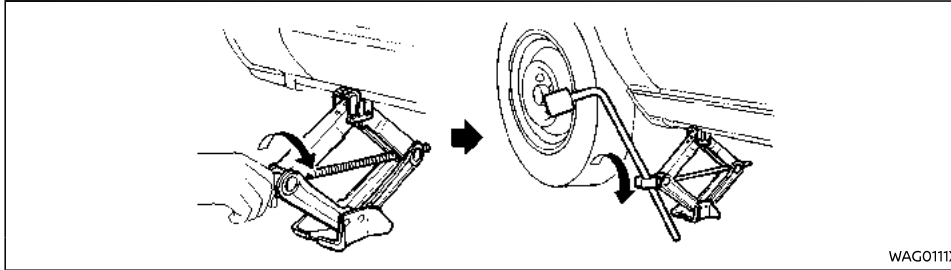

WARNING:

- Be sure to read and follow the instructions in this section.
- **DO NOT GET UNDER A VEHICLE THAT IS SUPPORTED BY A JACK.**
- Never use a jack which is not provided with your vehicle.
- The jack, which is provided with your vehicle, is designed only to lift your vehicle during a tire change. Do not use the jack provided with your vehicle on other vehicles.
- Never jack up the vehicle at a location other than the jack-up point that is specified.
- Never lift the vehicle more than necessary.
- Never use blocks on or under the jack.
- Never start or run the engine while the vehicle is on the jack. The vehicle may move suddenly, and this may cause an accident.

- Never allow passengers to remain in the vehicle while the tire is off the ground.
- If the vehicle is parked on the hard shoulder, you must warn other road users of your vehicle's presence with a warning triangle.
- It is forbidden to lift the car by placing any jack under front control arms, rear axle and subframe.

1. Place the jack directly under the jack-up point as illustrated so that the top of the jack contacts the vehicle at the jack-up point.

The jack should be placed on firm level ground.

2. Align the jack head with the jack-up point of either the front or the rear section.
3. Fit the groove of the jack head on the jack-up points as shown.
4. Loosen each wheel bolt, counterclockwise, one or two turns with the wheel bolt wrench.

Do not remove the wheel bolts until the tire is off the ground.

5. Carefully raise the vehicle until the clearance between the tire and ground is achieved.
6. To lift the vehicle, securely hold the jack lever and wheel bolt wrench with both hands and turn the jack lever.

Removing tire

1. Remove all 4 wheel bolts.
2. Remove the damaged tire.

CAUTION:

The tire is heavy. Be sure that your feet are clear from the tire and use gloves as necessary to avoid injury.

INSTALLING SPARE TIRE

WARNING:

Inflating an unsecured tire is dangerous. If it bursts, it could be hurled into the air with explosive force resulting in serious personal injury or death. Never inflate a tire unless it is secured to the vehicle or a tire mounting machine.

- Check your tire pressures, including your spare tire, monthly and before long trips or carrying extra weight. Be sure to use an accurate pressure gauge.
- Check inflation pressure when the tires are "cold". Tires are considered "cold" when the vehicle has been parked for three hours or more, or if the vehicle has been driven less than a mile at moderate speed.
- If your tires lose more than 2 psi (14 kPa) per month, the tire, the valve, or wheel may be damaged. Get it checked by

dealer to ensure that it is safe to use.

- Use valve caps to keep the valves clear of debris and to help guard against inflation pressure loss.
- Never fit more than one emergency spare tire wheel to the same vehicle.
- Replace the emergency spare wheel as soon as possible with the original one.

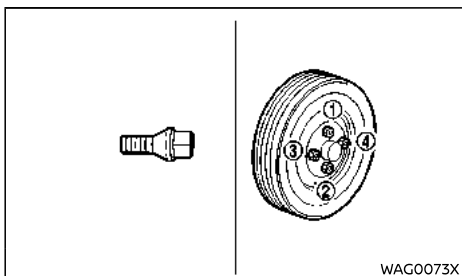

WARNING:

- Never use wheel bolts which are not provided with your vehicle. Incorrect wheel bolts or improperly tightened wheel bolts may cause the wheel to become loose or come off. This could cause an accident.
 - Never use oil or grease on the screw holes in the hub or wheel bolts. This may cause the wheel bolts to become loose.
 - The temporary-use spare tire (if equipped) is designed for emergency use only.
1. Clean any mud or dirt from the surface between the wheel and hub.

6-6 In case of emergency

2. Carefully put the spare tire on and tighten the wheel bolts with your fingers.
3. Tighten the wheel bolts alternately and evenly in the sequence illustrated (① - ④), more than 2 times with the wheel bolt wrench, until they are tight.
4. Lower the vehicle slowly until the tire touches the ground.
5. Tighten the wheel bolts securely, with the wheel bolt wrench, in the sequence illustrated.
6. Lower the vehicle completely.

Tighten the wheel bolts to the specified torque with a torque wrench as soon as possible.

**Wheel bolt tightening torque:
110 N·m (11 kg·m, 81 ft·lb)**

The wheel bolts must be kept tightened to specification at all times. It is recommended that the wheel bolts be tightened to specification at each lubrication interval.

WARNING:

Retighten the wheel bolts when the vehicle has been driven for 1,000 km (600 miles) (also in cases of a flat tire, etc.).

STOWING DAMAGED TIRE AND TOOLS

WARNING:

Be sure that the tire, jack and tools used are properly stored after use. Such items can become dangerous projectiles in an accident or sudden stop.

1. Securely store the damaged tire, the jack and tools in the storage area.
2. Close the back door.

JUMP STARTING

WARNING:

- Incorrect jump starting can lead to a battery explosion. The battery explosion may result in severe injury or death. It may also result in damage to the vehicle. Be sure to follow the instructions in this section.
- Explosive hydrogen gas is always present in the vicinity of the battery. Keep all sparks and flames away from the battery.
- Always wear suitable eye protection and remove rings, bracelets, and any other jewelry whenever working on or near a battery.
- Never lean over the battery while jump starting.
- Never allow battery fluid to come into contact with eyes, skin, clothes or the vehicle's painted surfaces. Battery fluid is a corrosive sulfuric acid which can cause severe burns. If the fluid comes into contact with anything, immediately flush the contacted area with plenty of water.
- Keep the battery out of the reach of children.
- The booster battery must be rated at 12 volts. Use of an incorrectly rated battery will damage your vehicle.
- Never attempt to jump start a frozen battery. It could explode and cause serious injury.

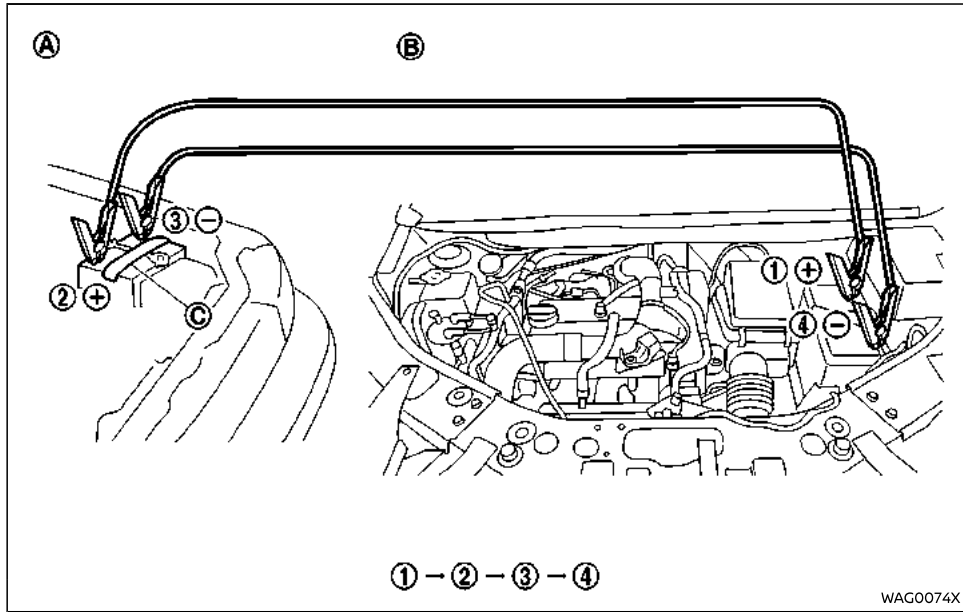

1. If the booster battery is in another vehicle **A**, position the two vehicles **A** and **B** to bring the batteries into close proximity to each other.

CAUTION:

If the battery of vehicle **B** equipped with the Intelligent Key system is discharged, the ignition switch cannot be moved from the "LOCK" position and, if the steering lock is engaged, the steering wheel cannot be moved. Connect the jumper cables to the

booster vehicle **A before turning the ignition switch and disengaging the steering lock.**

2. Apply the parking brake.
3. Continuously Variable Transmission (CVT) model: Move the shift lever to the "P" (Park) position.
Manual Transmission (MT) model: Move the shift lever to the "N" (Neutral) position.
4. Switch off all unnecessary electrical systems (headlights, heater, air conditioner, etc.).

In case of emergency 6-7

5. Place the ignition switch in the "LOCK" position.
6. Remove the vent caps, if equipped, on the battery.
7. Cover the battery with a firmly wrung out moist cloth to reduce the hazard of an explosion.
8. Connect the jumper cables in the sequence as illustrated (①, ②, ③, ④).



CAUTION:

- Be sure that the jumper cables do not touch moving parts in the engine compartment.
 - Be sure that the jumper cable's clamps do not contact any other metal.
9. Start the engine of the booster vehicle Ⓐ and let it run for a few minutes.
 10. Depress the accelerator pedal of the booster vehicle Ⓐ at about 2,000 rpm.
 11. Start the engine of the jumped vehicle Ⓑ in the normal manner.



CAUTION:

Never keep the starter motor engaged for more than 10 seconds. If the engine does not start right away, wait at least 10 seconds before trying again.

12. After the engine is started, carefully disconnect the jumper cables in the opposite sequence from that illustrated (④, ③, ②, ①).
13. Remove and dispose of the cloth as it may be contaminated with corrosive acid.
14. Replace the vent caps, if removed.

PUSH STARTING

Do not attempt to start the engine by pushing the vehicle.



CAUTION:

- **Continuously Variable Transmission (CVT)/Manual Transmission (MT) model cannot be started by pushing. Attempting to do so may cause damage to the transmission.**
- **Three-way catalyst equipped model should not be started by pushing. Attempting to do so may cause damage to the catalyst.**
- **Never try to start the engine by towing. When the engine starts, the forward surge could cause the vehicle to collide with the towing vehicle.**

IF YOUR VEHICLE OVERHEATS



WARNING:

- **Never continue driving if your vehicle overheats. Doing so could cause engine damage and/or a vehicle fire.**
- **Never open the hood if steam is coming out.**
- **Never remove the radiator or coolant reservoir cap while the engine is hot. If the radiator or coolant reservoir cap is removed when the engine is hot, pressurized hot water will spurt out and possibly cause burning, scalding or serious injury.**
- **If steam or coolant is coming from the engine, stand clear of the vehicle to prevent getting burned.**
- **The engine cooling fan will start at any time when the coolant temperature exceeds preset degrees.**
- **Be careful not to allow your hands, hair, jewelry or clothing to come into contact with, or to get caught in the cooling fan or drive belts.**

If your vehicle is overheating (indicated by the high temperature indicator), or if you feel a lack of engine power, detect unusual noise, etc., take the following steps:

1. Safely move the vehicle off the road away from traffic.
2. Turn on the hazard indicator flasher lights.
3. Apply the parking brake.
4. Continuously Variable Transmission (CVT) model: Move the shift lever to the "P" (Park) position.
Manual Transmission (MT) model: Move the shift lever to the "N" (Neutral) position.

TOWING YOUR VEHICLE

DO NOT STOP THE ENGINE.

5. Open all the windows.
6. Turn off the air conditioner. Move the temperature control to maximum hot and the fan control to high speed.
7. Get out from the vehicle.
8. Visually inspect and listen for steam or coolant escaping from the radiator before opening the hood. Wait until no steam or coolant can be seen before proceeding.
9. Open the engine hood.
10. Visually inspect if the cooling fan is running.
11. Visually inspect the radiator and radiator hoses for leakage.

If the cooling fan is not running or the coolant is leaking, stop the engine.

12. After the engine cools down, check the coolant level in the reservoir with the engine running. **Do not open the radiator cap.**
13. Add coolant to the reservoir if necessary.

Have your vehicle inspected/repared at a NISSAN dealer.

When towing your vehicle, local regulations for towing must be followed. Incorrect towing equipment could damage your vehicle. To assure proper towing and to prevent accidental damage to your vehicle, NISSAN recommends that you have professional road assistance personnel tow your vehicle. It is advisable to have the professional road assistant carefully read the following precautions.

TOWING PRECAUTIONS

- Be sure that the transmission, steering system, and drivetrain are in working condition before towing. If any units are damaged, the vehicle must be towed using a dolly or flatbed tow truck.
- NISSAN recommends that your vehicle be towed with the driving (front) wheels off the ground.
- Always attach safety chains before towing.

TOWING RECOMMENDED BY NISSAN

Two-Wheel Drive (2WD) models

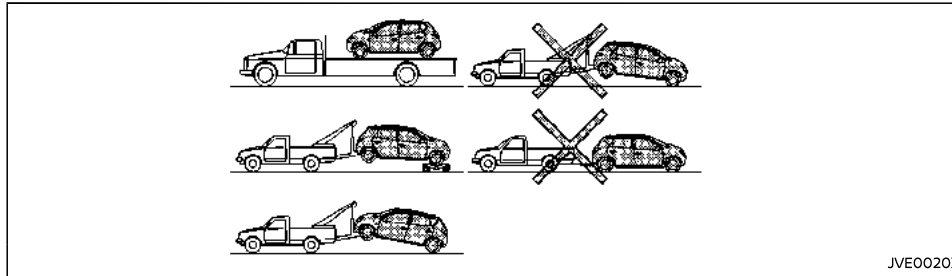

Front wheels on the ground:

NISSAN recommends that towing dollies be used under the front wheels when towing your vehicle or the vehicle be placed on a flatbed tow truck as illustrated.



CAUTION:

Never tow Continuously Variable Transmission (CVT) model with the front wheels on the ground. Doing so will cause serious and expensive damage to the drivetrain.

Manual Transmission (MT) model:

1. Place the ignition switch to stop the engine.
2. Secure the steering wheel in a straight-ahead position with rope or a similar device.
3. Move the shift lever to the "N" (Neutral) position.
4. Release the parking brake.

5. Attach safety chains whenever towing.

Rear wheels on the ground:

1. Place the ignition switch to stop the engine.
2. Secure the steering wheel in a straight-ahead position with rope or a similar device.
3. Move the shift lever to the "N" (Neutral) position.
4. Release the parking brake.
5. Attach safety chains whenever towing.

All four wheels on the ground:

NISSAN recommends that the vehicle be placed on a flatbed tow truck as illustrated.



CAUTION:

Never tow CVT model with all four wheels on the ground. Doing so will cause serious and expensive damage to the drivetrain.

Manual Transmission (MT) model:



CAUTION:

Never tow a MT model backward with all four wheels on the ground.

1. Place the ignition switch to stop the engine.
2. Move the shift lever to the "N" (Neutral) position.
3. Release the parking brake.

Freeing trapped vehicle



WARNING:

- **Never allow anyone to stand near the towing line during the pulling operation.**
- **Never spin the tires at high speed. This could cause them to explode and result in serious injury. Parts of the vehicle could also overheat and be damaged.**

In the event that your vehicle's tires become trapped in sand, snow, or mud, and the vehicle is unable to free itself without being pulled, use the recovery hook.

- Use the recovery hook only. Do not attach the pulling device to any other part of the vehicle body. Otherwise, the vehicle body may be damaged.
- Use the recovery hook to free a vehicle only.
- The recovery hook is under tremendous stress when used to free a trapped vehicle. Always pull the pulling device straight out from the vehicle. Never pull on the recovery hook at an angle.

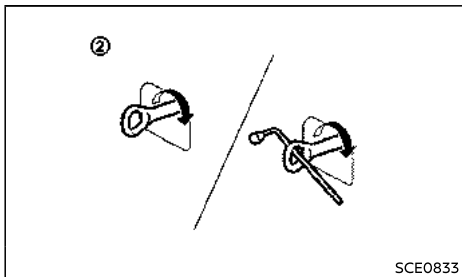
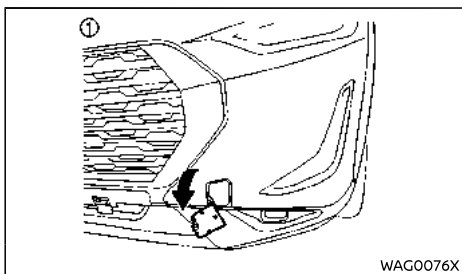

- ① Remove the hook cover from the bumper with a suitable tool.
- ② Securely install the recovery hook as illustrated. (The hook is stored with the jacking tools.)

Make sure that the recovery hook is properly secured in its storage area after use.

MEMO

6-12 **In case of emergency**

7 Appearance and care

Cleaning exterior	7-2	Cleaning interior	7-3
Washing	7-2	Air fresheners	7-4
Removing spots	7-2	Floor mats	7-4
Waxing	7-2	Glass	7-4
Glass	7-2	Seat belts	7-4
Underbody	7-3	Corrosion protection	7-5
Wheels	7-3	Most common factors contributing to vehicle corrosion	7-5
Aluminum alloy wheels (if equipped)	7-3	Environmental factors influence rate of corrosion	7-5
Chrome parts	7-3	To protect your vehicle from corrosion	7-5

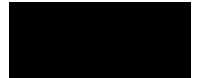

CLEANING EXTERIOR

In order to maintain the appearance of your vehicle, it is important to take proper care of it. Whenever possible, park your vehicle inside a garage or in a covered area to minimize the chances of damaging the paint surface of your vehicle.

When it is necessary to park outside, park in a shady area or protect the vehicle with a body cover. **Be careful not to scratch the paint surface when putting on or removing the body cover.**

WASHING

In the following instances, wash your vehicle as soon as possible to protect the paint surface:

- After a rainfall, which may cause the paint surface damage from acid rain.
 - After driving on coastal roads, which may cause rusting from the sea breeze.
 - When contaminants such as soot, bird droppings, tree sap, metal particles or bugs get on the paint surface.
 - When dust or mud builds up on the paint surface.
1. Wash the vehicle surface with a wet sponge and plenty of water.
 2. Clean the vehicle surface gently and thoroughly using a mild soap, a special vehicle soap or a general purpose dishwashing liquid mixed with clean, lukewarm (never hot) water.



CAUTION:

- **Do not wash the vehicle with strong household soap, strong chemical detergents, gasoline or solvents.**

- **Do not wash the vehicle in direct sunlight or while the vehicle body is hot, as the paint surface may become water-spotted.**
 - **Avoid using tight-napped or rough cloths, such as washing mitts. Care must be taken when removing caked-on dirt or other foreign substances so the paint surface is not scratched or damaged.**
3. Rinse the vehicle thoroughly with plenty of clean water.
 4. Use a dampened chamois to dry the paint surface and avoid leaving water spots.

When washing the vehicle, take care of the following:

- Inside flanges, joints and folds on the doors, hatches and hood are particularly vulnerable to the effects of road salt. Therefore, these areas must be cleaned regularly.
- Be sure that the drain holes in the lower edge of the doors are not clogged.
- Spray water to the underbody and in the wheel wells to loosen the dirt and/or wash away road salt.

REMOVING SPOTS

Remove tar and oil spots, industrial dust, insects, and tree sap as quickly as possible from the paint surface to avoid lasting damage or staining. Special cleaning products are available at a NISSAN dealer or any automotive accessory store.

WAXING

Regular waxing protects the paint surface and helps maintain a new vehicle appearance.

After waxing, polishing is recommended to remove built-up residue and to avoid a weathered appearance.

A NISSAN dealer can assist you in choosing the appropriate waxing products.



CAUTION:

- **Wash your vehicle thoroughly and completely before applying wax to the paint surface.**
- **Always follow the manufacturer's instructions supplied with the wax.**
- **Do not use a wax containing any abrasives, cutting compounds or cleaners that may damage the vehicle finish.**

Machine compounding or aggressive polishing on a base coat/clear coat paint finish may dull the finish or leave swirl marks.

GLASS

Use glass cleaner to remove smoke and dust film from the glass surfaces. It is normal for glass to become coated with a film after the vehicle is parked in the hot sun. Glass cleaner and a soft cloth will easily remove this film.

UNDERBODY

In areas where road salt is used in the winter, it is necessary to clean the vehicle's underbody regularly in order to prevent dirt and salt from building up and causing the acceleration of corrosion on the underbody and suspension.

Before the winter and again in the spring, the underseal must be checked and, if necessary, re-treated.

WHEELS

- Wash the wheels when washing the vehicle to maintain their appearance.
- Clean the inner side of the wheels when the wheel is changed or the underside of the vehicle is washed.
- Do not use abrasive cleaners when washing the wheels.
- Inspect wheel rims regularly for dents or corrosion. This may cause loss of pressure or damage the tire bead.
- NISSAN recommends that the road wheels be waxed to protect against road salt in areas where it is used during winter.

ALUMINUM ALLOY WHEELS (if equipped)

Wash the wheels regularly with a sponge dampened in a mild soap solution, especially during winter in areas where road salt is used. The salt residue from road salt could discolor the wheels if it is not washed off regularly.



CAUTION:

Follow the directions below to avoid staining or discoloring the wheels:

- **Do not use a cleaner that uses strong acid or alkali contents to clean the wheels.**

- **Do not apply wheel cleaners to the wheels when they are hot. The wheel temperature should be the same as ambient temperature.**
- **Rinse the wheel to completely remove the cleaner within 15 minutes after the cleaner is applied.**

CHROME PARTS

Clean all chrome parts regularly with a non-abrasive chrome polish to maintain the finish.

CLEANING INTERIOR

Occasionally remove loose dust from the interior trim, floor carpets, plastic parts and seats using a vacuum cleaner or soft bristled brush. Wipe the vinyl and leather surfaces with a clean, soft cloth dampened in mild soap solution, then wipe clean with a dry, soft cloth.

Regular care and cleaning is required in order to maintain the appearance of the leather.

Before using any fabric protector, read the manufacturer's recommendations. Some fabric protectors contain chemicals that may stain or bleach the seat material.

Use a soft cloth dampened only with water to clean the meter and gauge lens covers.



CAUTION:

- **Never use benzene, thinner or any similar material.**
- **Small dirt particles can be abrasive and damaging to leather surfaces and should be removed promptly. Do not use saddle soap, car waxes, polishes, oils, cleaning fluids, solvents, detergents or ammonia-based cleaners as they damage the leather natural finish.**
- **Never use fabric protectors unless recommended by the manufacturer.**
- **Do not use glass or plastic cleaner on meter or gauge lens covers. It may damage the lens covers.**

AIR FRESHENERS

Most air fresheners use a solvent that could affect the vehicle interior. If you use an air freshener, take the following precautions:

- Hanging-type air fresheners can cause permanent discoloration when they contact vehicle interior surfaces. Place the air freshener in a location that allows it to hang free and not contact an interior surface.
- Liquid-type air fresheners typically clip on the vents. These products can cause immediate damage and discoloration when spilled on interior surfaces.

Carefully read and follow the manufacturer's instructions before using air fresheners.

FLOOR MATS

WARNING:

To avoid potential pedal interference that may result in a collision, injury or death:

- **NEVER** place a floor mat on top of another floor mat in the driver front position or install them upside down or backwards.
- Use only genuine NISSAN floor mats or equivalent floor mats that are specifically designed for use in your vehicle model and model year.
- Properly position the mats in the floorwell using the floor mat positioning hooks. See "Floor mat installation" (P.7-4).
- Make sure the floor mat does not interfere with pedal operation.
- Periodically check the floor mats to make sure they are properly installed.

- **After cleaning the vehicle interior, check the floor mats to make sure they are properly installed.**

The use of genuine NISSAN floor mats can extend the life of your vehicle carpet and make it easier to clean the interior. Mats should be maintained with regular cleaning and replaced if they become excessively worn.

Floor mat installation

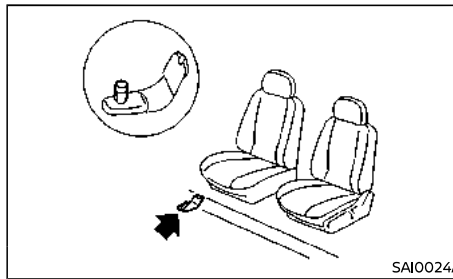

Front (example)

Your vehicle is equipped with floor mat positioning hook(s). The number and shape of the floor mat positioning hooks for each seating position varies depending on the vehicle.

GLASS

Use glass cleaner to remove smoke and dust film from the glass surfaces. It is normal for glass to become coated with a film after the vehicle is parked in the hot sun. Glass cleaner and a soft cloth will easily remove this film.

CAUTION:

When cleaning the inside of the windows, do not use sharp-edged tools, abrasive cleaners or chlorine-based disinfectant cleaners. They

could damage the electrical conductors, such as rear window defogger elements.

SEAT BELTS

WARNING:

- **Do not allow wet seat belts to roll up in the retractor.**
- **Never use bleach, dye or chemical solvents to clean the seat belts, since these materials may severely weaken the seat belt webbing.**

The seat belts can be cleaned by wiping them with a sponge dampened in a mild soap solution.

Allow the belts to dry completely in the shade before using them. (See "Seat belts" (P.1-6).)

CORROSION PROTECTION

MOST COMMON FACTORS CONTRIBUTING TO VEHICLE CORROSION

- The accumulation of moisture-retaining dirt and debris in body panel sections, cavities, and other areas.
- Damage to the paint surface and other protective coatings caused by gravel and stone chips or minor traffic accidents.

ENVIRONMENTAL FACTORS INFLUENCE RATE OF CORROSION

Moisture

The accumulation of sand, dirt and water on the inside floor of the vehicle can accelerate corrosion. Wet floor carpet/floor mats will not dry completely inside the vehicle. They should be removed and completely dried to avoid floor panel corrosion.

Relative humidity

Corrosion will be accelerated in areas of high relative humidity.

Temperature

High temperatures accelerate the rate of corrosion to those parts which are not well ventilated.

Corrosion will also be accelerated in areas where the temperatures stay above freezing.

Air pollution

Industrial pollution, the presence of salt in the air in coastal areas, or heavy road salt use accelerates the corrosion process. Road salt also accelerates the disintegration of paint surfaces.

TO PROTECT YOUR VEHICLE FROM CORROSION

- Wash and wax your vehicle often to keep the vehicle clean.
- Always check for minor damage to the paint surface and if any exists, repair it as soon as possible.
- Keep the drain holes in the lower edge of the doors open to avoid water accumulation.
- Check the vehicle underbody for accumulation of sand, dirt or salt. If present, wash with water as soon as possible.



CAUTION:

- **Never remove dirt, sand or other debris from the passenger compartment by washing it out with a hose. Remove dirt with a vacuum cleaner.**
- **Never allow water or other liquids to come in contact with electronic components inside the vehicle as this may damage them.**

Chemicals used for road surface deicing are extremely corrosive. They accelerate corrosion and deterioration of underbody components such as the exhaust system, fuel and brake lines, brake cables, floor pan and fenders.

In the winter, the underbody must be cleaned periodically.

For additional protection against rust and corrosion, which may be required in some areas, consult a NISSAN dealer.

MEMO

7-6 Appearance and care

8 Maintenance and do-it-yourself

General maintenance	8-2	Wiper blades	8-15
Explanation of general maintenance items	8-2	Windshield wiper blades	8-15
Maintenance precautions	8-3	Rear window wiper blade	8-15
Maintenance requirements	8-4	Window washer fluid	8-16
Scheduled maintenance	8-4	Battery	8-17
General maintenance	8-4	Vehicle battery	8-17
Where to go for service	8-5	Remote controller battery	8-17
Engine compartment check locations	8-5	Intelligent Key battery	8-18
BR10 HS engine model	8-5	Fuses	8-19
HRA0DET engine model	8-6	Engine compartment	8-19
Engine cooling system	8-6	Passenger compartment	8-22
Checking engine coolant level	8-7	Lights	8-25
Changing engine coolant	8-7	Headlights	8-25
Engine oil	8-8	Exterior lights	8-25
Checking engine oil level	8-8	Interior lights	8-26
Changing engine oil and oil filter	8-8	Light locations	8-26
Drive belt	8-10	Tires and wheels	8-28
Spark plugs	8-11	Tire Pressure Monitoring System (TPMS) (if equipped)	8-28
Nickel-tipped spark plugs	8-11	Tire inflation pressure	8-28
Brakes	8-11	Types of tires	8-28
Checking parking brake	8-11	Tire chains	8-29
Checking foot brake pedal	8-11	Tire rotation	8-29
Brake booster	8-12	Tire wear and damage	8-29
Brake fluid	8-12	Tire age	8-30
Clutch fluid (if equipped)	8-13	Changing tires and wheels	8-30
Continuously Variable Transmission (CVT) fluid (if equipped)	8-14	Wheel balance	8-30
Air cleaner filter	8-14	Spare tire	8-30

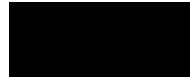

GENERAL MAINTENANCE

During normal day-to-day operation of the vehicle, general maintenance should be performed regularly as prescribed in this section. If you detect any unusual sounds, vibrations or smells, be sure to check for the cause or have a NISSAN dealer do it promptly. In addition, you should notify a NISSAN dealer if you think that repairs are required.

When performing any checks or maintenance work, closely observe "Maintenance precautions" (P.8-3).

EXPLANATION OF GENERAL MAINTENANCE ITEMS

Additional information on the following items with "" is found later in this section.

Outside vehicle

The maintenance items listed here should be performed from time to time, unless otherwise specified.

Doors and hood:

Check that all doors and the hood operate smoothly as well as the back door, trunk lid and hatch. Also make sure that all latches lock securely. Lubricate if necessary. Make sure that the secondary latch keeps the hood from opening when the primary latch is released. When driving in areas using road salt or other corrosive materials, check lubrication frequently.

Lights*:

Clean the headlights on a regular basis. Make sure that the headlights, stop lights, tail lights, turn signal lights, and other lights are all operating properly and installed securely. Also check the aim of the headlights.

Tires*:

Check the pressure with a gauge often and always prior to long distance trips. Adjust the pressure in all tires, including the spare, to the pressure specified. Check carefully for damage, cuts or excessive wear.

Tire rotation*:

In the case that Two-Wheel Drive (2WD) and front and rear tires are same size; tires should be rotated every 10,000 km (6,000 miles). Tires marked with directional indicators can only be rotated between front and rear. Make sure that the directional indicators point in the direction of wheel rotation after the tire rotation is completed.

In the case that Four-Wheel Drive and All-Wheel Drive (4WD/AWD) and front and rear tires are same size; tires should be rotated every 5,000 km (3,000 miles). Tires marked with directional indicators can only be rotated between front and rear. Make sure that the directional indicators point in the direction of wheel rotation after the tire rotation is completed.

In the case that front tires are different size from rear tires; tires cannot be rotated.

The timing for tire rotation may vary according to your driving habits and the road surface conditions.

Tire Pressure Monitoring System (TPMS) transmitter components (if so equipped):

Replace the TPMS transmitter grommet seal, valve core and cap when the tires are replaced due to wear or age.

Wheel alignment and balance:

If the vehicle should pull to either side while driving on a straight and level road, or if you detect uneven or abnormal tire wear, there may be a need for wheel alignment. If the steering wheel or seat vibrates at normal highway speeds, wheel balancing may be needed.

Windshield:

Clean the windshield on a regular basis. Check the windshield at least every six months for cracks or other damage. Repair as necessary.

Wiper blades*:

Check for cracks or wear if not functioning correctly. Replace as necessary.

Inside vehicle

The maintenance items listed here should be checked on a regular basis, such as when performing periodic maintenance, cleaning the vehicle, etc.

Accelerator pedal:

Check the pedal for smooth operation and make sure that the pedal does not catch or require uneven effort. Keep the floor mats away from the pedal.

Brake pedal*:

Check the pedal for smooth operation and make sure that it is the proper distance from the floor mat when depressed fully. Check the brake booster function. Be sure to keep the floor mats away from the pedal.

Parking brake*:

Check the parking brake operation regularly. Check that the lever (if so equipped) or the pedal (if so equipped) has the proper travel. Also make sure that the vehicle is held securely on a fairly steep hill when only the parking brake is applied.

Seat belts:

Check that all parts of the seat belt system (for example, buckles, anchors, adjusters and retractors) operate properly and smoothly, and are installed securely. Check the belt webbing for cuts, fraying, wear or damage.

Steering wheel:

Check for changes in the steering condition, such as excessive play, hard steering or strange noises.

Warning lights and chimes:

Make sure that all warning lights and chimes are operating properly.

Windshield defogger:

Check that the air comes out of the defogger outlets properly and in good quantity when operating the heater or air conditioner.

Windshield wiper and washer*:

Check that the wipers and washer operate properly and that the wipers do not streak.

Under hood and vehicle

The maintenance items listed here should be checked periodically (for example, each time you check the engine oil or refuel).

Battery (except for maintenance free batteries)*:

Check the fluid level in each cell. It should be between the UPPER and LOWER lines. Vehicles operated in high temperatures or under severe conditions require frequent checks of the battery fluid level.

Brake (and clutch) fluid level(s)*:

For Manual Transmission (MT) model; make sure that the brake and clutch fluid levels are between the MAX and MIN lines on the reservoirs.

Except for Manual Transmission (MT) model; make sure that the brake fluid level is between the MAX and MIN lines on the reservoir.

Engine coolant level*:

Check the coolant level when the engine is cold. Make sure that the coolant level is between the MAX and MIN lines on the reservoir.

Engine drive belt(s)*:

Make sure that drive belt(s) is not frayed, worn, cracked or oily.

Engine oil level*:

Check the level after parking the vehicle (on a level ground) and turning off the engine.

Fluid leaks:

Check under the vehicle for fuel, oil, water or other fluid leaks after the vehicle has been parked for a while. Water dripping from the air conditioner after use is normal. If you should notice any leaks or if fuel fumes are evident, check for cause and have it corrected immediately.

Windshield washer fluid*:

Check that there is adequate fluid in the reservoir.

MAINTENANCE PRECAUTIONS

When performing any inspection or maintenance work on your vehicle, always take care to prevent serious accidental injury to yourself or damage to the vehicle. The following are general precautions which should be closely observed.

**WARNING:**

- **Park the vehicle on a level surface, apply the parking brake securely and block the wheels to prevent the vehicle from moving. Move the shift lever to the "P" (Park) position (Continuously Variable Transmission (CVT) model) or to the "N" (Neutral) position (Manual Transmission (MT) model).**
- **Be sure the ignition switch is in the "OFF" or "LOCK" position when performing any parts replacement or repairs.**
- **Do not work under the hood while the engine is hot. Always turn off the engine and wait until it cools down.**
- **If you must work with the engine running, keep your hands, clothing, hair and tools away from moving fans, belts and any other moving parts.**
- **It is advisable to secure or remove any loose clothing and any jewelry, such as rings, watches, etc. before working on your vehicle.**
- **If you must run the engine in an enclosed space such as a garage, be sure there is proper ventilation for exhaust gases to**

escape.

- **Never get under the vehicle while it is supported by a jack.**
- **Keep smoking materials, flame and sparks away from fuel and the battery.**
- **Never connect or disconnect either the battery or any transistorized component connector while the ignition switch is in the "ON" position.**
- **On gasoline engine models with the Multiport Fuel Injection (MFI) system, the fuel filter and fuel lines should be serviced by a NISSAN dealer because the fuel lines are under high pressure even when the engine is turned off.**
- **Your vehicle is equipped with an automatic engine cooling fan. It may come on at any time without warning, even if the ignition switch is in the "OFF" or "LOCK" position and the engine is not running. To avoid injury, always disconnect the negative battery cable before working near the fan.**
- **Always wear eye protection whenever you work on your vehicle.**
- **Never leave the engine or transmission related component harness connector disconnected while the ignition switch is in the "ON" position.**
- **Avoid direct contact with used engine oil and coolant. Improperly disposed engine oil, engine coolant, and/or other vehicle fluids can hurt the environment. Always conform to local regulations for disposal of vehicle fluids.**

This "8. Maintenance and do-it-yourself" section provides instructions regarding only those items which are relatively easy for an owner

8-4 Maintenance and do-it-yourself

to perform.

You should be aware that incomplete or improper servicing may result in operating difficulties or excessive emissions, and could affect your warranty coverage. **If in doubt about any servicing, have it done by a NISSAN dealer.**

MAINTENANCE REQUIREMENTS

Some day-to-day and regular maintenance is essential to maintain your vehicle's good mechanical condition, as well as its emission and engine performance.

It is the owner's responsibility to make sure that the specified maintenance, as well as general maintenance, is performed.

As the vehicle owner, you are the only one who can ensure that your vehicle receives the proper maintenance care.

SCHEDULED MAINTENANCE

For your convenience, the required scheduled maintenance items are described and listed in a separate Warranty Information and Maintenance booklet. You must refer to that booklet to ensure that necessary maintenance is performed on your vehicle at regular intervals.

GENERAL MAINTENANCE

General maintenance includes those items which should be checked during normal day-to-day operation of the vehicle. They are essential if your vehicle is to continue to operate properly. It is your responsibility to perform these procedures regularly as prescribed.

Performing general maintenance checks requires minimal mechanical skill and only a few general automotive tools.

These checks or inspections can be done by yourself, a qualified technician, or if you prefer, your NISSAN dealer.

ENGINE COMPARTMENT CHECK LOCATIONS

WHERE TO GO FOR SERVICE

If maintenance service is required or your vehicle appears to malfunction, have the systems checked and tuned by a NISSAN dealer.

BR10 HS ENGINE MODEL

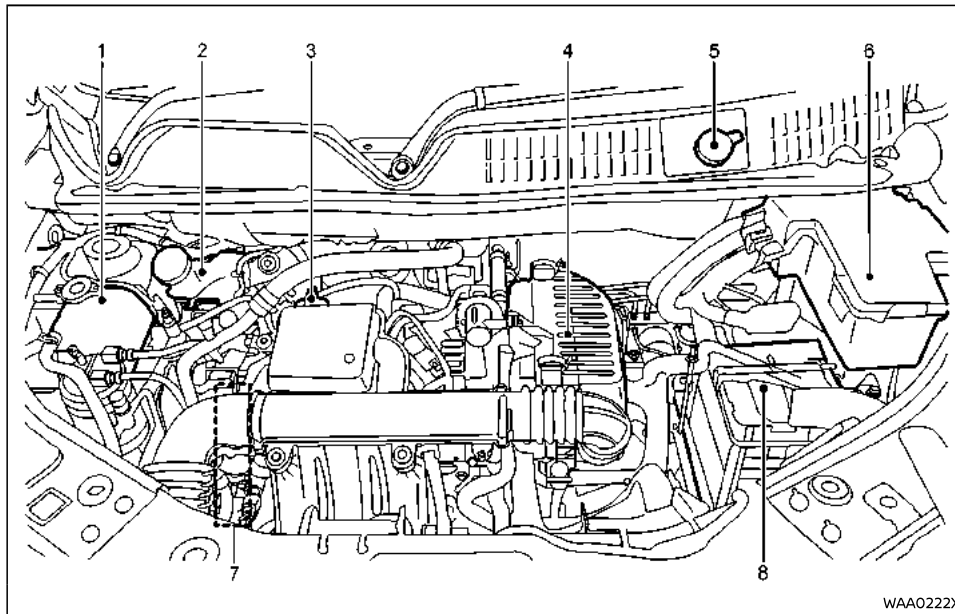

1. Engine coolant reservoir
2. Brake and clutch fluid reservoir
3. Engine oil filler cap
— Engine oil dipstick
4. Air cleaner
5. Window washer fluid reservoir
6. Fuse/fusible link holders
7. Engine drive belt location
8. Battery

HRAO-DET ENGINE MODEL

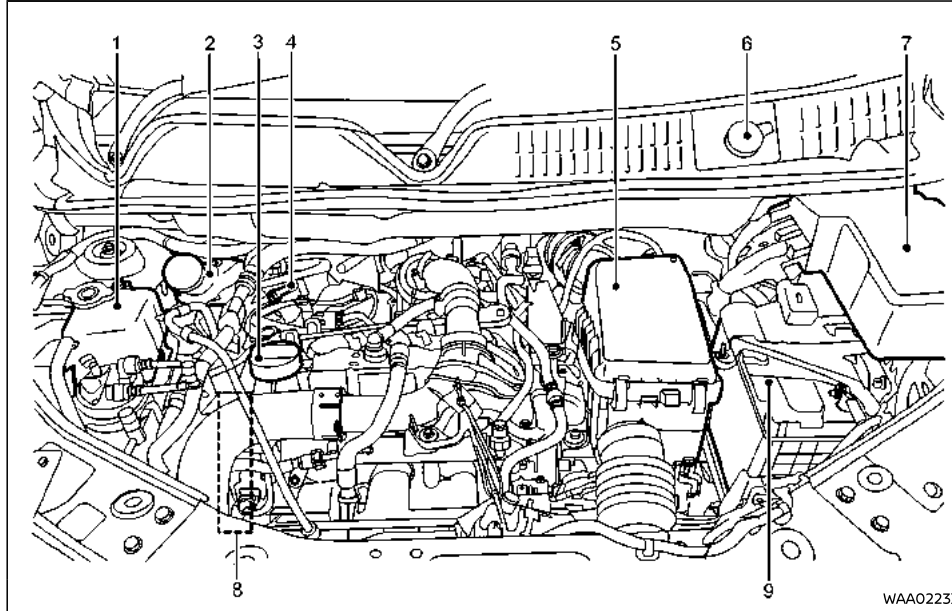

- | | |
|--------------------------------------|---------------------------------------|
| 1. Engine coolant reservoir | 9. Battery |
| 2. Brake and clutch* fluid reservoir | *: For Manual Transmission (MT) Model |
| 3. Engine oil filler cap | |
| 4. Engine oil dipstick | |
| 5. Air cleaner | |
| 6. Window washer fluid reservoir | |
| 7. Fuse/fusible link holders | |
| 8. Engine drive belt location | |

8-6 Maintenance and do-it-yourself

ENGINE COOLING SYSTEM



WARNING:

- Never remove the radiator or coolant reservoir cap when the engine is hot. Serious burns could be caused by high-pressure fluid escaping from the radiator. Wait until the engine and radiator cool down.
- Engine coolant is poisonous and should be stored carefully in marked containers out of the reach of children.
- If the engine was stopped soon when the engine is hot, the cooling fan may operate for approximately 10 minutes (HRAO-DET engine) after the engine was stopped to cool the components in the engine compartment. When the cooling fan is operating, be sure that hands or other items do not get caught in it.

The engine cooling system is filled at the factory with a high-quality, year-round, anti-freeze coolant solution. The anti-freeze solution contains rust and corrosion inhibitors, therefore additional cooling system additives are not necessary.



CAUTION:

- Never use any cooling system additives such as radiator sealer. Additives may clog the cooling system and cause damage to the engine, transmission and/or cooling system.
- When adding or replacing coolant, be sure to use only Genuine NISSAN Engine Coolant or equivalent in its quality with the proper mixture ratio. Examples of the mixture ratio of coolant and water are shown in the following table:

For BR10 HS engine model

Outside temperature down to		Engine coolant (concentrated)	Demineralized or distilled water
°C	°F		
-15	5	30%	70%

For HRAODET engine model

Outside temperature down to		Engine coolant (concentrated)	Demineralized or distilled water
°C	°F		
-15	5	30%	70%
-35	-30	50%	50%

The use of other types of coolant solutions may damage the engine cooling system.

The radiator is equipped with a pressure cap. To prevent engine damage, use only a Genuine NISSAN radiator cap or its equivalent when replacement is required.

CHECKING ENGINE COOLANT LEVEL

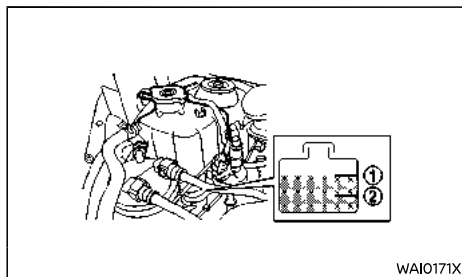

BR10 HS engine



HRAODET engine

Check the coolant level in the reservoir when the engine is cold. If the coolant level is below MIN level ②, add coolant up to the MAX level ①. Tighten the cap securely after adding engine coolant.

If the cooling system frequently requires coolant, have it checked by a NISSAN dealer.

CHANGING ENGINE COOLANT

Contact a NISSAN dealer if replacement is required.

Major engine cooling system repair should be performed by a NISSAN dealer. The service procedures can be found in the appropriate NISSAN Service Manual.

Improper servicing can result in reduced heater performance and engine overheating.

⚠ WARNING:

- **To avoid being scalded, never change the coolant when the engine is hot.**
- **Never remove the radiator or coolant reservoir cap when the engine is hot. Serious burns could be caused by high pressure fluid escaping from the radiator.**

- **Avoid direct skin contact with used coolant. If skin contact is made, wash thoroughly with soap or hand cleaner as soon as possible.**
- **Keep coolant out of the reach of children and pets.**

Engine coolant must be disposed of properly. Check your local regulations.

ENGINE OIL

CHECKING ENGINE OIL LEVEL

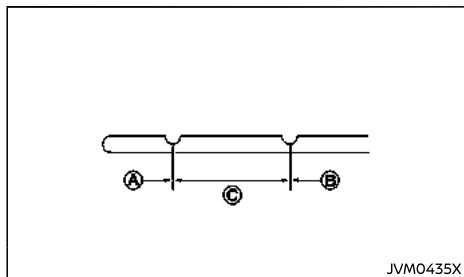

BR10 HS engine

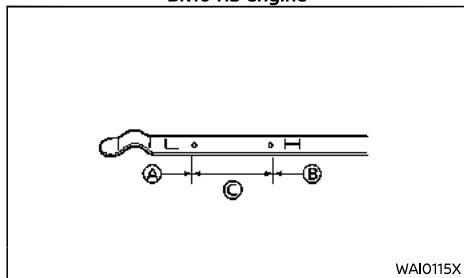

HRA0DET engine

1. Park the vehicle on a level surface and apply the parking brake.
2. Start the engine and warm it up until the engine temperature reaches the normal operating temperature (approximately 5 minutes).
3. Stop the engine.
4. Wait at least 10 minutes for the engine oil to drain back to the oil pan.

5. Remove the dipstick and wipe it clean.
For BR10 HS engine, the engine oil dipstick is attached to the engine oil filler cap. Open the engine oil filler cap to remove the dipstick.
6. Reinsert the dipstick all the way.
7. Remove the dipstick and check the oil level. It should be within the range C.
8. If the oil level is below A, remove the oil filler cap and pour the recommended oil into the opening. Do not overfill B.

When filling the engine oil, do not remove the dipstick.

9. Recheck the oil level with the dipstick.

It is normal to add some oil between oil maintenance intervals or during the break-in period, depending on the severity of operating conditions.



CAUTION:

The oil level should be checked regularly. Operating your vehicle with an insufficient amount of oil can damage the engine, and such damage is not covered by the warranty.

CHANGING ENGINE OIL AND OIL FILTER



WARNING:

- **Used oil must be disposed of properly. Never pour or dump oil into the ground, canals, rivers, etc. It should be disposed of at proper waste facilities. NISSAN recommends having your oil changed by a NISSAN dealer.**
- **Be careful not to burn yourself, as the engine oil may be hot.**

- **Prolonged and repeated contact with used engine oil may cause skin cancer.**
- **Avoid direct skin contact with used oil. If contacted, wash thoroughly with soap or hand cleaner and plenty of water as soon as possible.**
- **Store used engine oil in marked containers out of the reach of children.**

1. Park the vehicle on a level surface and apply the parking brake.
2. Start the engine and warm it up until the engine temperature reaches the normal operating temperature (approximately 5 minutes).
3. Stop the engine.
4. Wait at least 10 minutes for the engine oil to drain back to the oil pan.
5. Raise and support the vehicle using a suitable floor jack and safety jack stands.
 - Place the safety jack stands under the vehicle jack-up points.
 - A suitable adapter should be attached to the jack stand saddle.

Engine oil and filter (BR10 HS engine model)

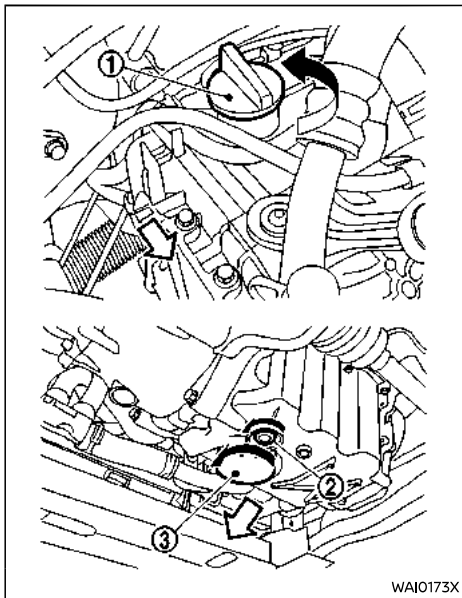

- ① Oil filler cap
- ② Oil drain plug
- ③ Oil filter

1. Place a large drain pan under the drain plug.
2. Remove the drain plug ② with a wrench.
3. Remove the oil filler cap ① and completely drain the oil.
If the oil filter is to be changed, remove and replace it at this time.

CAUTION:

Waste oil must be disposed of properly. Check your local regulations.

4. Loosen the oil filter ③ with an oil filter wrench.
5. Remove the oil filter by turning it by hand.
6. Wipe the engine oil filter mounting surface with a clean cloth.
Be sure to remove any old gasket remaining on the mounting surface.
7. Apply new engine oil to the gasket of the new oil filter.
8. Screw in the oil filter until a slight resistance is felt and then tighten an additional 2/3 of a turn to secure the filter.

Oil filter tightening torque:
 $14 \pm 2 \text{ N}\cdot\text{m}$
 $(1.4 \pm 0.2 \text{ kg}\cdot\text{m}, 10 \pm 1 \text{ ft}\cdot\text{lb})$

9. Clean and reinstall the drain plug and new washer. Securely tighten the drain plug with a wrench. Do not use excessive force.

Drain plug tightening torque:
 $25 \pm 4 \text{ N}\cdot\text{m}$
 $(2.6 \pm 0.4 \text{ kg}\cdot\text{m}, 18 \pm 3 \text{ ft}\cdot\text{lb})$

10. Refill the recommended engine oil and quantity. (See "Recommended fluids/lubricants and capacities" (P.9-2).)
When filling the engine oil, do not remove the dipstick.
11. Securely install the oil filler cap.
12. Start the engine.
13. Check the drain plug for any sign of leakage.

14. Dispose of the used oil in the proper manner. Check your local regulations.
15. Check the engine oil level according to the proper procedure. (See "Checking engine oil level" (P.8-8).)

Engine oil and filter (HRA0DET engine model)

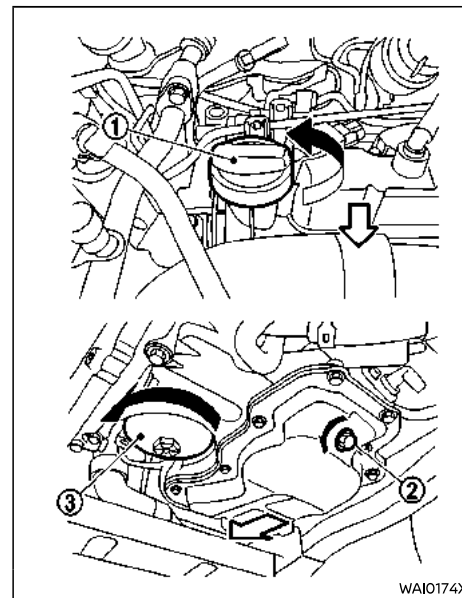

- ① Oil filler cap
- ② Oil drain plug
- ③ Oil filter

1. Place a large drain pan under the drain plug.

2. Remove the drain plug ② with a wrench.
3. Remove the oil filler cap ① and completely drain the oil.
If the oil filter is to be changed, remove and replace it at this time.



CAUTION:

Waste oil must be disposed of properly. Check your local regulations.

4. Loosen the oil filter ③ with an oil filter wrench.
5. Remove the oil filter by turning it by hand.
6. Wipe the engine oil filter mounting surface with a clean cloth.
Be sure to remove any old gasket remaining on the mounting surface.
7. Apply new engine oil to the gasket of the new oil filter.
8. Screw in the oil filter until a slight resistance is felt and then tighten an additional 2/3 of a turn to secure the filter.

Oil filter tightening torque:

**20 to 25 N·m
(2.0 to 2.6 kg·m, 15 to 18 ft·lb)**

9. Clean and reinstall the drain plug and new washer. Securely tighten the drain plug with a wrench. Do not use excessive force.

Drain plug tightening torque:

**29 to 38 N·m
(3.0 to 3.9 kg·m, 21 to 28 ft·lb)**

10. Refill the recommended engine oil and quantity. (See "Recommended fluids/lubricants and capacities" (P.9-2).)

When filling the engine oil, do not remove the dipstick.

11. Securely install the oil filler cap.
12. Start the engine.
13. Check the drain plug for any sign of leakage.
14. Dispose of the used oil in the proper manner. Check your local regulations.
15. Check the engine oil level according to the proper procedure. (See "Checking engine oil level" (P.8-8).)

After the operation

1. Lower the vehicle carefully to the ground.
2. Dispose of waste oil and filter properly.

DRIVE BELT

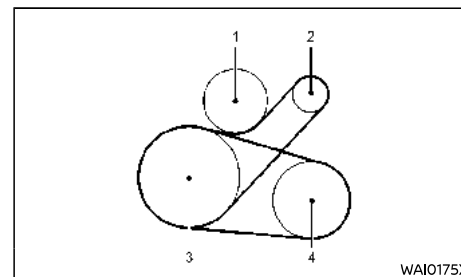

BR10 HS engine

1. Water pump
2. Alternator
3. Crankshaft pulley
4. Air conditioner compressor

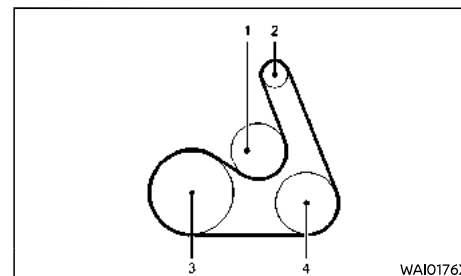

HRA0DET engine

1. Water pump
2. Alternator
3. Crankshaft pulley
4. Air conditioner compressor

Be sure the ignition switch is in the "OFF" or "LOCK" position.

Visually inspect the belt for signs of unusual wear, cuts, fraying or looseness. Check regu-

larily for condition. If the belt is in poor condition or loose, have it replaced or adjusted by a NISSAN dealer.

SPARK PLUGS

WARNING:

Be sure the engine and ignition switch are off and that the parking brake is applied.

Replace the spark plugs according to the maintenance log shown in a separate maintenance booklet.

If replacement is required, contact a NISSAN dealer.

NICKEL-TIPPED SPARK PLUGS

CAUTION:

- **Do not reuse the nickel-tipped spark plugs by cleaning or re-gapping.**
- **Always replace with the recommended nickel-tipped spark plugs.**

BRAKES

CHECKING PARKING BRAKE

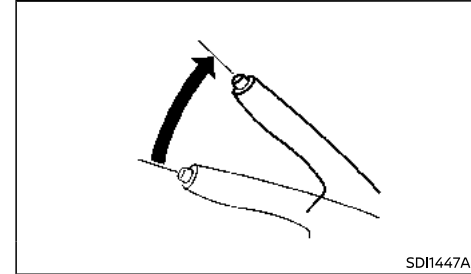

From the released position, pull the parking brake lever up slowly and firmly. If the number of clicks is out of the range listed, see a NISSAN dealer.

8 to 12 clicks
Pulling force 196 N (20 kg, 44 lb)

CHECKING FOOT BRAKE PEDAL

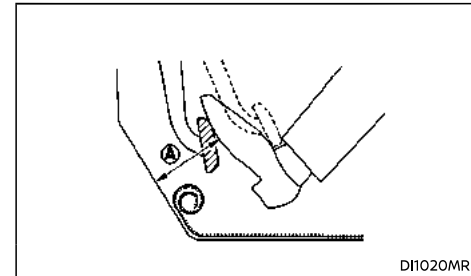



WARNING:

See a NISSAN dealer for a brake system check if the foot brake pedal height does not return to normal.

With the engine running, check the distance \textcircled{A} between the upper surface of the pedal and the metal floor. If it is out the range listed, see a NISSAN dealer.

\textcircled{A} : **60 mm (2.36 in) or more**
Depressing force: 490 N (50 kg, 110 lb)

Self-adjusting brakes

Your vehicle is equipped with self-adjusting brakes. The disc-type brakes self-adjust every time the foot brake pedal is applied.

BRAKE BOOSTER

Check the brake booster function as follows:

1. With the engine off, depress and release the foot brake pedal several times. When the brake pedal movement (distance of travel) remains the same from one pedal application to the next, continue on to the next step.
2. While depressing the foot brake pedal, start the engine. The pedal height should drop a little.
3. With the foot brake pedal depressed, stop the engine. Keep the pedal depressed for about 30 seconds. The pedal height should not change.
4. Run the engine for 1 minute without depressing the foot brake pedal, then turn it off. Depress the foot brake pedal several times. The pedal travel distance will decrease gradually with each depression as the vacuum is released from the booster.

If the brakes do not operate properly, have the brakes checked by a NISSAN dealer.

BRAKE FLUID



WARNING:

- Use only new fluid from a sealed container. Old, inferior, or contaminated fluid may damage the brake system. The use of improper fluids can damage the brake system and affect the vehicle's stopping ability.
- Clean the filler cap before removing.
- Brake fluid is poisonous and should be stored carefully in marked containers out of the reach of children.



CAUTION:

Do not spill the fluid on painted surfaces. This will damage the paint. If fluid is spilled, wash it off with plenty of water immediately.

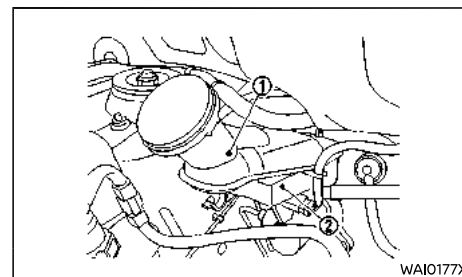

Check the fluid level in the reservoir. If the fluid is below the MIN line $\textcircled{2}$, the brake warning light will illuminate. Add fluid up to the MAX line $\textcircled{1}$. (For recommended types of fluid, see "Recommended fluids/lubricants and capacities" (P.9-2).)

If the fluid must be added frequently, the system should be thoroughly checked by a

NISSAN dealer.

CLUTCH FLUID (if equipped)

WARNING:

- Use only new fluid from a sealed container. Old, inferior, or contaminated fluid may damage the clutch system. The use of improper fluids can damage the clutch system.
- Clean the filler cap before removing.
- Clutch fluid is poisonous and should be stored carefully in marked containers out of the reach of children.

CAUTION:

Do not spill the clutch fluid on painted surfaces. This will damage the paint. If clutch fluid is spilled, wash it off with plenty of water immediately.

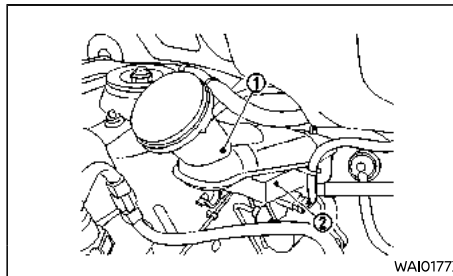

Check the fluid level in the reservoir. The brake fluid reservoir is shared with the clutch system for manual transmissions. If the fluid is below the MIN line ②, add fluid up to the MAX line ①. (For recommended types of fluid, see "Recommended fluids/lubricants and capacities" (P.9-2).)

If the fluid must be added frequently, the clutch

system should be thoroughly checked by a NISSAN dealer.

CONTINUOUSLY VARIABLE TRANSMISSION (CVT) FLUID (if equipped)

Contact a NISSAN dealer if checking or replacement is required.

CAUTION:

- Use only Genuine NISSAN CVT Fluid NS-3. Do not mix with other fluids.
- Using transmission fluid other than Genuine NISSAN CVT Fluid NS-3 will damage the CVT, which is not covered by the warranty.
- Contact a NISSAN dealer or qualified workshop for details or servicing.

AIR CLEANER FILTER

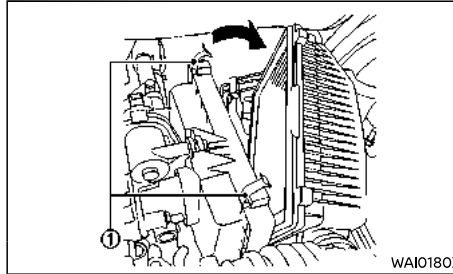

BR10 HS engine

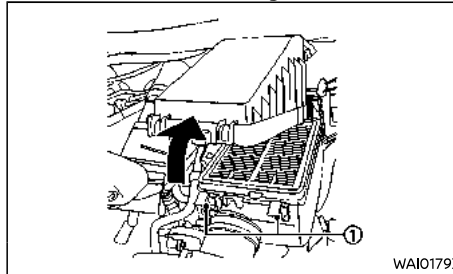

HRAODET engine

WARNING:

Operating the engine with the air cleaner filter off can cause you or others to be burned. The air cleaner filter not only cleans the intake air, it also stops flame if the engine backfires. If the air cleaner filter is not installed and the engine backfires, you could be burned. Never drive with the air cleaner filter off. Be cautious working on the engine when the air cleaner filter is off.

To remove the filter from the air cleaner, release the two retaining clips ①, then open

the air cleaner box.

The air cleaner filter element may be cleaned and reused. Replace the air filter according to the maintenance log shown in a separate maintenance booklet.

When replacing the air filter, wipe the inside of the air cleaner housing and the cover with a damp cloth.

Contact a NISSAN dealer if maintenance or replacement is required.

WIPER BLADES

WINDSHIELD WIPER BLADES

Cleaning

If the windshield does not become clear after using the windshield washer or if the wiper blades chatter when operating the windshield wipers, wax or other materials may be on the windshield and/or wiper blades.

Clean the outside of the windshield surface with a washer solution or mild detergent. Your windshield is clean if beads do not form when rinsing with water.

Clean the blade by wiping it with a cloth soaked in a washer solution or a mild detergent. Rinse the blade with water. If your windshield is still not clear after cleaning the blades and using the wipers, replace the blades.

When a washer nozzle is clogged:

See a NISSAN dealer if a washer nozzle is clogged or any malfunction occurs. Do not attempt to clean the nozzle using a needle or a pin. Doing so may damage the nozzle.

Replacing

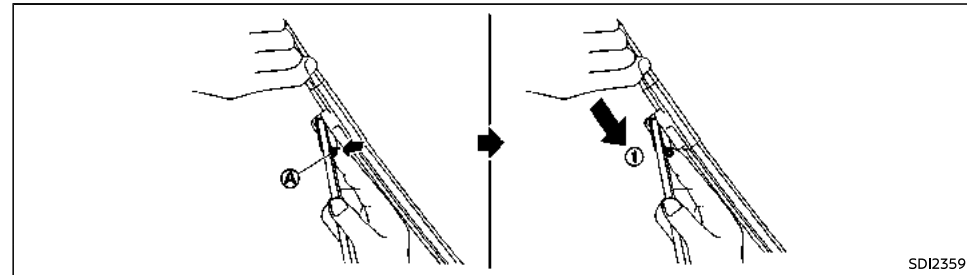

Replace the wiper blades if they are worn.

1. Lift the wiper arm away from the windshield.
2. Push and hold the release tab **A**, and then move the wiper blade down the wiper arm to remove **1**.
3. Remove the wiper blade.
4. Insert the new wiper blade onto the wiper arm until it clicks into place.

CAUTION:

- After wiper blade replacement, return the wiper arm to its original position. Otherwise the wiper arm or the engine hood may be scratched and may cause damage when the engine hood is opened.
- Worn wiper blades can damage the windshield and impair driver vision.

REAR WINDOW WIPER BLADE

Contact a NISSAN dealer if checking or replacement is required.

WINDOW WASHER FLUID

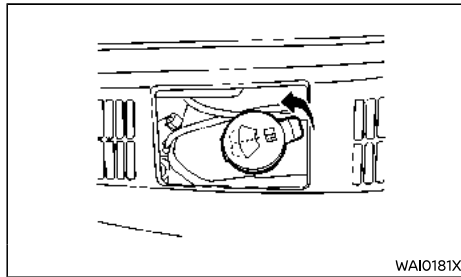







WARNING:

Anti-freeze is poisonous and should be stored carefully in marked containers out of the reach of children.

Check the fluid level in the window washer fluid reservoir. If the fluid level is low, add window washer fluid.

Fill the window washer fluid reservoir periodically. Add a washer solvent to the water for better cleaning. In the winter season, add a windshield washer anti-freeze. Follow the manufacturer's instructions for the mixture ratio.

BATTERY

Caution symbols for battery		⚠ WARNING	
①		No smoking, No exposed flames, No sparks	Never smoke around battery. Never expose battery to open flames or electrical sparks.
②		Shield eyes	Handle the battery cautiously. Always wear eye protection glasses to protect against explosion or battery acid.
③		Keep away from children	Never allow children to handle battery. Keep the battery out of the reach of children.
④		Battery acid	Do not allow battery fluid to contact your skin, eyes, fabrics, or painted surfaces. After handling the battery or battery cap, immediately wash your hands thoroughly. If the battery fluid gets into your eyes, or onto your skin or clothing, flush with water immediately for at least 15 minutes and seek medical attention. Battery fluid is acid. If the battery fluid gets into your eyes or onto your skin, it could cause loss of your eyesight or burns.
⑤		Note operating instructions	Before handling the battery, read this instruction carefully to ensure correct and safe handling.
⑥		Explosive gas	Hydrogen gas, generated by battery fluid, is explosive.

SD11573

VEHICLE BATTERY

Maintenance free battery

For a maintenance free battery, it is not required to check the fluid level. However, NISSAN recommends to check it periodically at a NISSAN dealer.

Jump starting

If jump starting is necessary, see "Jump starting" (P.6-7). If the engine does not start by jump starting or the battery does not charge, the battery may have to be replaced. Contact a NISSAN dealer for replacing the battery.

REMOTE CONTROLLER BATTERY

Battery replacement



CAUTION:

- Be careful not to allow children to swallow the battery and removed parts.
- An improperly disposed battery can harm the environment. Always confirm local regulations for battery disposal.

Maintenance and do-it-yourself 8-17

- **When changing batteries, do not let dust or oil get on the components.**
- **There is danger of explosion if the lithium battery is incorrectly replaced. Replace only with the same or equivalent type.**
- **Do not expose the battery to excessive heat such as sunshine, fire, etc.**

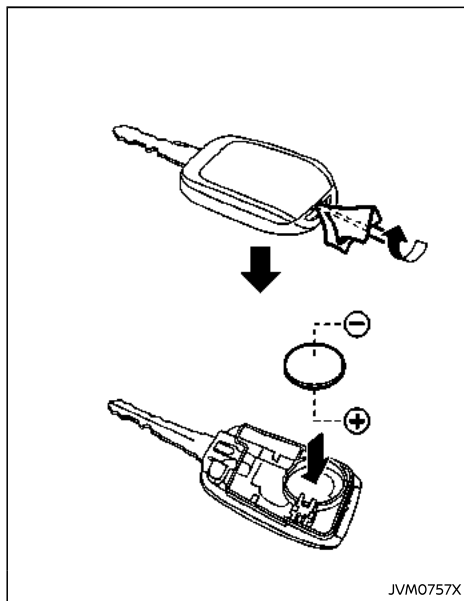

To replace the battery:

1. Insert a small screwdriver into the slit of the remote controller and twist it to separate the cover from the remote controller. Use a cloth to protect the casing.

2. Replace the battery with a new one.
Recommended battery: CR2032 or equivalent
 - Do not touch the internal circuit and electric terminals as doing so could cause a malfunction.
 3. Close the cover on the remote controller and push them together until it is securely closed.
 4. Operate the buttons to check its operation.
- See a NISSAN dealer if you need assistance for replacement.

INTELLIGENT KEY BATTERY

Battery replacement

⚠ CAUTION:

- **Be careful not to allow children to swallow the battery and removed parts.**
- **An improperly disposed battery can harm the environment. Always confirm local regulations for battery disposal.**
- **When changing batteries, do not let dust or oil get on the components.**
- **There is danger of explosion if lithium battery is incorrectly replaced. Replace only with the same or equivalent type.**
- **Do not expose the battery to excessive heat such as sunshine, fire, etc.**

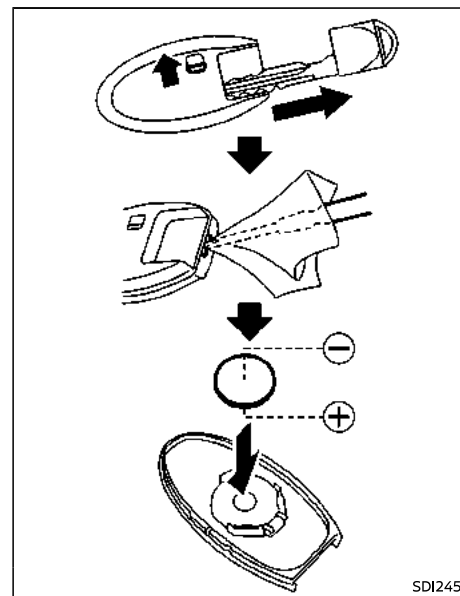

To replace the battery:

1. Release the lock knob at the back of the key and remove the mechanical key. (See "Mechanical key" (P.3-3).)
2. Insert a flat-blade screwdriver wrapped with a cloth into the slit of the corner and twist it to separate the upper part from the lower part.
3. Replace the battery with a new one.
 - Recommended battery: CR2032H or equivalent

- Do not touch the internal circuit and electric terminals as doing so could cause a malfunction.
- Make sure that the + side faces the bottom of the case.

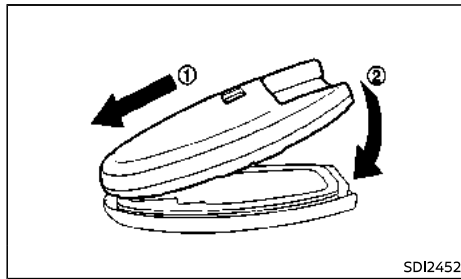

4. Align the tips of the upper and lower parts ①, and then push them together until it is securely closed ②.
5. Operate the buttons to check its operation. See a NISSAN dealer if you need assistance for replacement.

FUSES

ENGINE COMPARTMENT

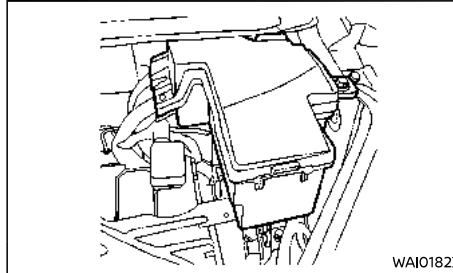

CAUTION:

- **Never use a fuse of a higher or lower amperage rating than that specified on the fuse box cover. This could damage the electrical system or cause a fire.**
- **Never use wire or wrapping foil in place of a fuse. This could damage the electrical system or cause a fire.**

If any electrical equipment does not operate, check for an open fuse.

1. Be sure the ignition switch is in the "OFF" or "LOCK" position.
2. Be sure the headlight switch is in the "OFF" position.
3. Open the engine hood and open the fuse/fusible link holder cover.
4. Locate the fuse that needs to be replaced.
5. Remove the fuse with a suitable tool.

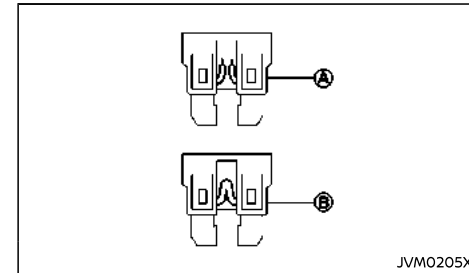

Example

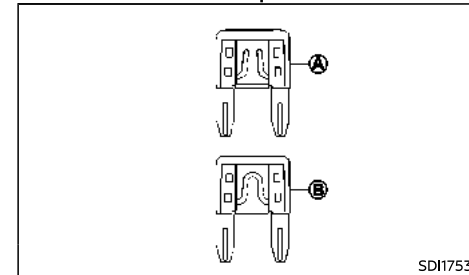

Example

6. If the fuse is open ①, replace it with a new fuse ②.

If the new fuse also opens, after installing, have the electrical system checked, and if necessary repaired, by a NISSAN dealer.

Fusible links

If any electrical equipment does not operate and the fuses are in good condition, check the fusible links. If any of these fusible links are melted, replace only with genuine NISSAN parts.

Fuse location with amperage

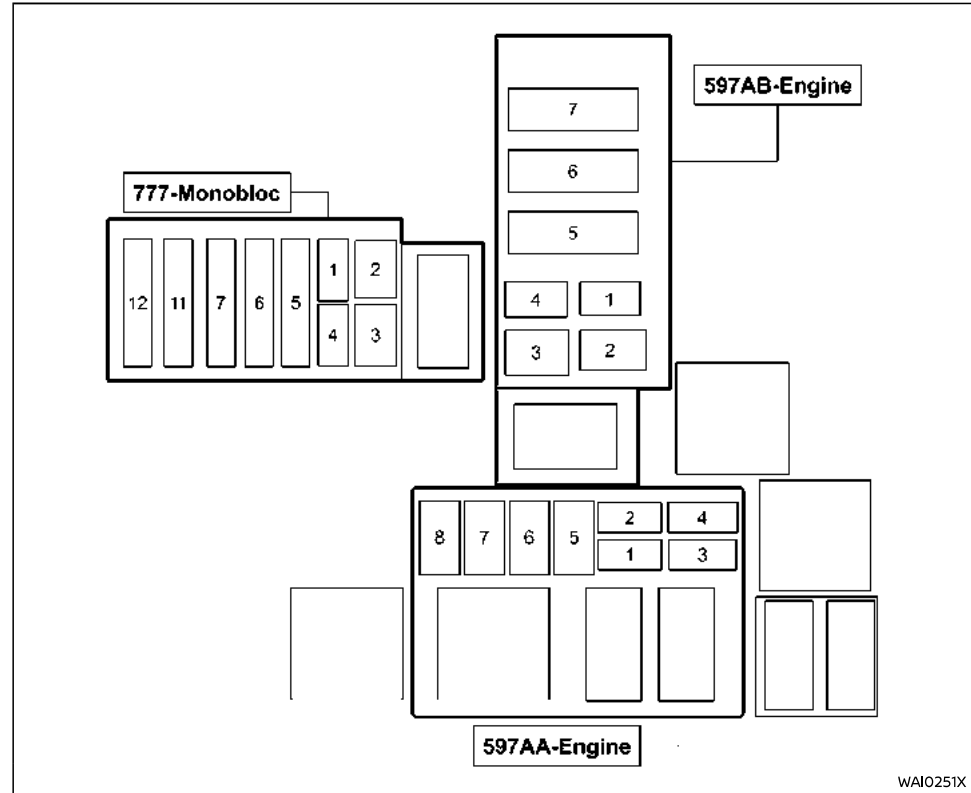

597AB-ENGINE FUSE DETAILS:

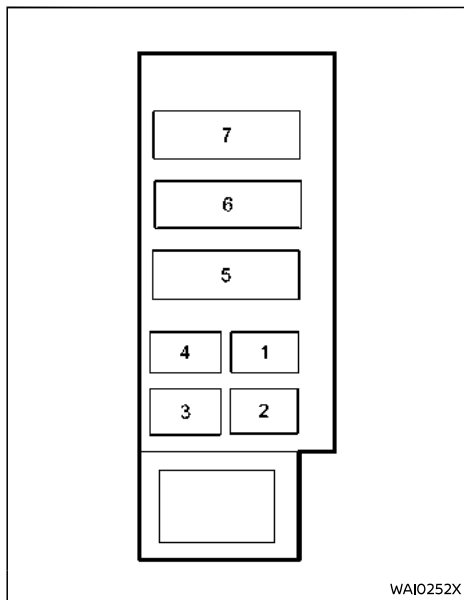

BR10 HS engine model

1. AC COMPRESSOR (15A)
2. STARTER (30A)
3. Empty location
4. INJECTION SYSTEM (25A)
5. RADIATOR MOTOR FAN MT (40A)
6. Empty location
7. Empty location

HRAODET engine model

1. AC COMPRESSOR (15A)

2. STARTER (30A)
3. Empty location
4. INJECTION SYSTEM (25A)
5. RADIATOR MOTOR FAN MT (40A)
6. RADIATOR MOTOR FAN CVT (50A)
7. Empty location

777-MONOBLOC HARN FUSE DETAILS:

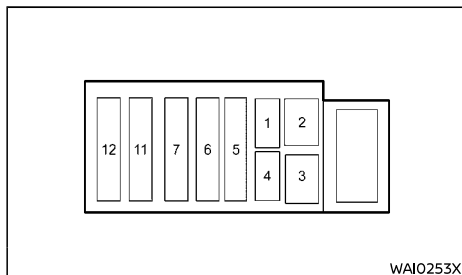

BR10 HS engine model

1. DEFOGGER (30A)
2. FOG LAMP (7.5A)
3. BCM (7.5A)
4. ABS/VDC (25A)
5. EPS MOTOR (80A)
6. HABITACLE-1 (70A)
7. HABITACLE-2 (80A)
11. ABS/VDC (50A)
12. RR ACC SUPPLY (30A)

HRAODET engine model

1. DEFOGGER (30A)
2. FOG LAMP (7.5A)
3. BCM (7.5A)
4. ABS/VDC (25A)

5. EPS MOTOR (80A)
6. HABITACLE-1 (70A)
7. HABITACLE-2 (80A)
11. ABS/VDC (50A)
12. RR ACC SUPPLY (30A)

597AA-ENGINE FUSE DETAILS:

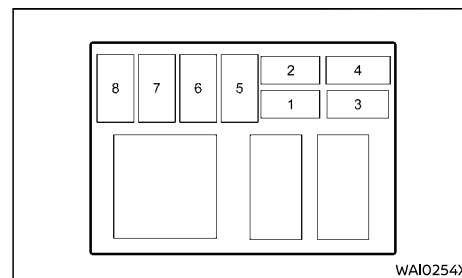

BR10 HS engine model

1. AC DIODE (1A)
2. RAD DIODE (1A)
3. Empty location
4. Empty location
5. Empty location
6. INJECTION SYSTEM (15A)
7. FUEL SYSTEM (10A)
8. Empty location

HRAODET engine model

1. AC DIODE (1A)
2. RAD DIODE (1A)
3. CVT ECU (20A)
4. THROTTLE CONTROL (15A)
5. Empty location
6. INJECTION SYSTEM (15A)

7. FUEL SYSTEM (10A)

8. Empty location

The presence of certain fuses depends on the vehicle equipment level.

The information of fuse location in this manual is one in effect at the time of printing.

PASSENGER COMPARTMENT

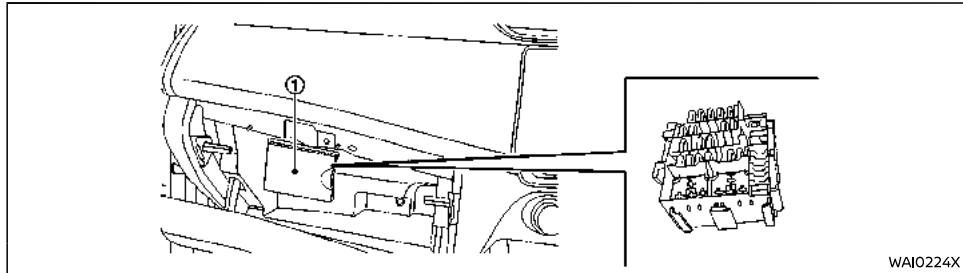

WAI0224X



CAUTION:

- **Never use a fuse of a higher or lower amperage rating than that specified on the fuse box cover. This could damage the electrical system or cause a fire.**

If any electrical equipment does not operate, check for an open fuse.

The fuse box is located on the inside of the glove box. To check the fuse, open the glove box lid and then open the fuse box lid ①.

1. Be sure the ignition switch is in the "OFF" or "LOCK" position.
2. Be sure the headlight switch is in the "OFF" position.
3. Open the glove box and open the fuse box lid ①.
4. Locate the fuse that needs to be replaced.
5. Remove the fuse with a suitable tool.

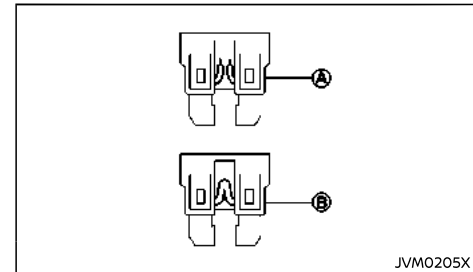

JVM0205X

Example

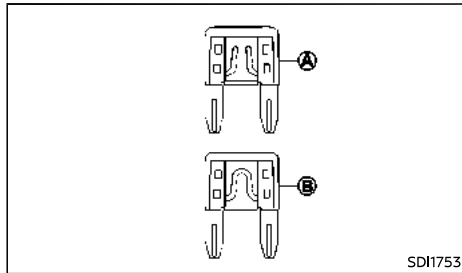

Example

6. If the fuse is open (A), replace it with a new fuse (B).

If the new fuse also opens, after installing, have the electrical system checked, and if necessary repaired, by a NISSAN dealer.

Fuse location with amperage

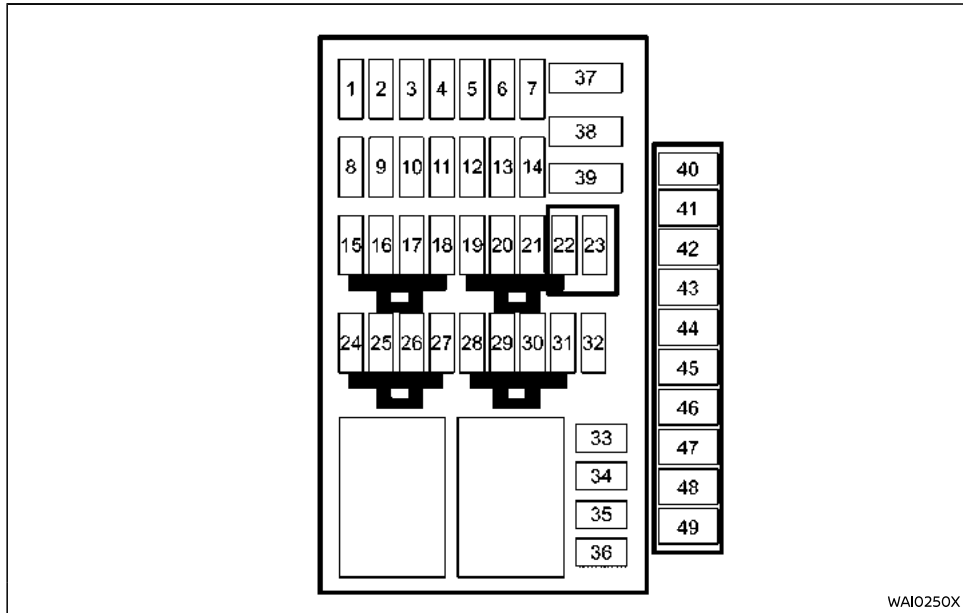

- | | |
|--------------------|---------------------|
| 1. Empty location | 9. BCM-1 (15A) |
| 2. Empty location | 10. Empty location |
| 3. CVT (7.5A) | 11. STARTER (5A) |
| 4. Empty location | 12. BAT TEMPO (10A) |
| 5. Empty location | 13. HORN (15A) |
| 6. Empty location | 14. BCM (15A) |
| 7. CHILD LOCK (5A) | 15. RADIO (15A) |
| 8. Empty location | 16. DOOR LOCK (25A) |

17. TCU (15A)
18. COMBI LPL (20A)
19. METER (10A)
20. COMBI LPH (25A)
21. HFM (20A)
22. HFM-1 (20A)
23. ORVM (5A)
24. AVM (10A)
25. DRL (5A)
26. REV LAMP & RR WIPER (15A)
27. FR WIPER (20A)
28. IGN-1 (5A)
29. EPS (5A)
30. AIRBAG (5A)
31. STOP LAMP & ULC (7.5A)
32. BAT TEMPO-1 (5A)
33. 2nd ROW CIGAR (15A)
34. 1st ROW CIGAR (15A)
35. FR DUAL WINDOW (30A)
36. DR WINDOW (25A)
37. BLOWER MOTOR (40A)
38. Empty location
39. Empty location
40. PARK ASSIST (5A)
41. CAN CENTRAL (10A)
42. RR PWN (30A)
43. ILLUMINATION (5A)
44. ACC (7.5A)
45. HL AIMER (7.5A)
46. HL LB R (7.5A)
47. HL LB L (7.5A)
48. HL HB R (7.5A)

49. HL HB L (7.5A)

The presence of certain fuses depends on the vehicle equipment level.

The information of fuse location in this manual is one in effect at the time of printing.

LIGHTS

HEADLIGHTS

Fog may temporarily form inside the lens of the exterior lights in the rain or in a car wash. A temperature difference between the inside and the outside of the lens causes the fog. This is not a malfunction. If large drops of water collect inside the lens, contact a NISSAN dealer.

LED headlight

If replacement is required, contact a NISSAN dealer.

Halogen headlight bulb

The halogen headlight is a semi-sealed beam type which uses replaceable headlight (halogen) bulbs. They can be replaced from inside the engine compartment without removing the headlight assembly.



CAUTION:

High-pressure halogen gas is sealed inside the bulb. The bulb may break if the glass envelope is scratched or the bulb is dropped.

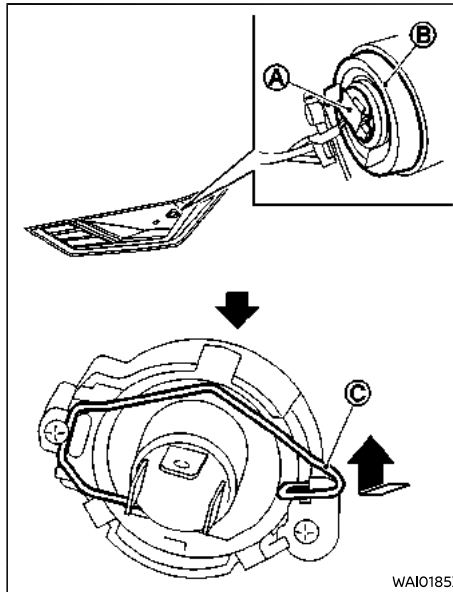

1. Disconnect the battery negative cable.
2. Disconnect the electrical connector (A) from the rear end of the bulb.
3. Pull off the rubber cap (B).
4. Push and turn the retaining pin (C) to loosen it.
5. Remove the headlight bulb. Do not shake or rotate the bulb when removing it.
6. Install the new bulb in the reverse order of removal.



CAUTION:

- When handling the bulb, do not touch the glass envelope.
- Do not leave the bulb out of the headlight reflector for a long period of time as dust, moisture and smoke may enter the headlight body and affect the performance of the headlight.

Use the same number and wattage as originally installed:

High/low beam bulb: 60/55W (H19)

Aiming adjustment is not necessary if only the bulbs are replaced. When aiming adjustment is necessary, contact a NISSAN dealer.

EXTERIOR LIGHTS

Item	Wattage (W)
Headlight	
Halogen headlight model	60/55
LED headlight model*	LED
Daytime running light (if equipped)*	LED
Front turn signal light	LED* or 21
Front clearance light*	LED or 5
Front fog light (if equipped)*	LED
Side turn signal light*	LED or 5
Rear combination lights	
Turn signal light	21
Stop/tail light	21/5
Tail light*	5
Reverse light*	16

Item	Wattage (W)
High-mounted stop light*	LED
License plate light*	5

*: See a NISSAN dealer for replacement.

INTERIOR LIGHTS

Item	Wattage (W)
Cargo room light (if equipped)*	5
Glove box light (if equipped)*	5
Front map light	5
Room light	5

*: See a NISSAN dealer for replacement.

LIGHT LOCATIONS

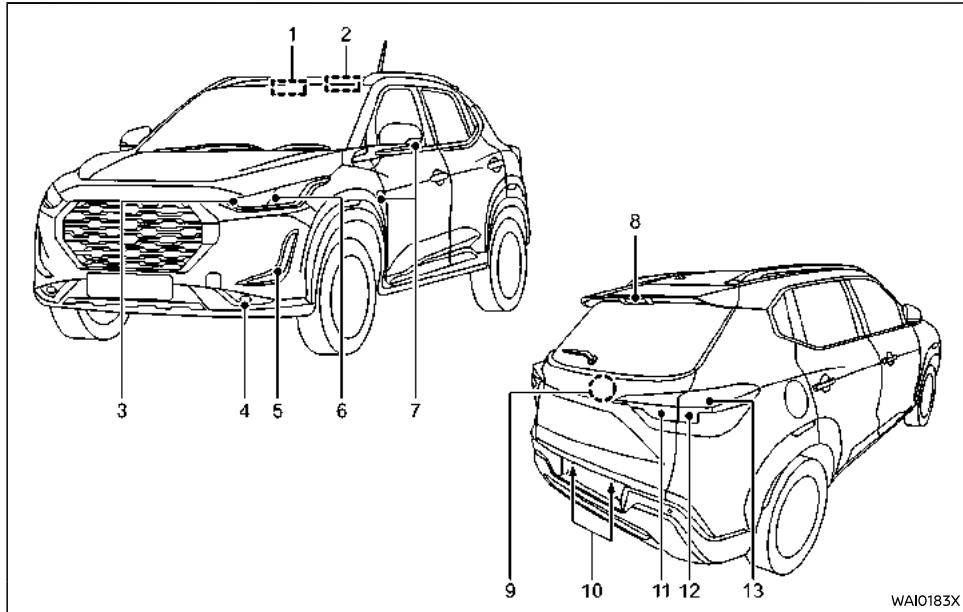

1. Front map light and front room light
2. Rear room light
3. Front turn signal light
4. Front fog light (if equipped)
5. Clearance light/daytime running light (if equipped)
6. Headlight/clearance light (if equipped)
7. Side turn signal light (on the outside mirror or front fender)
8. High-mounted stop light
9. Cargo room light (if equipped)
10. License plate light
11. Reverse light
12. Rear turn signal light
13. Stop/Tail light

Replacement procedures

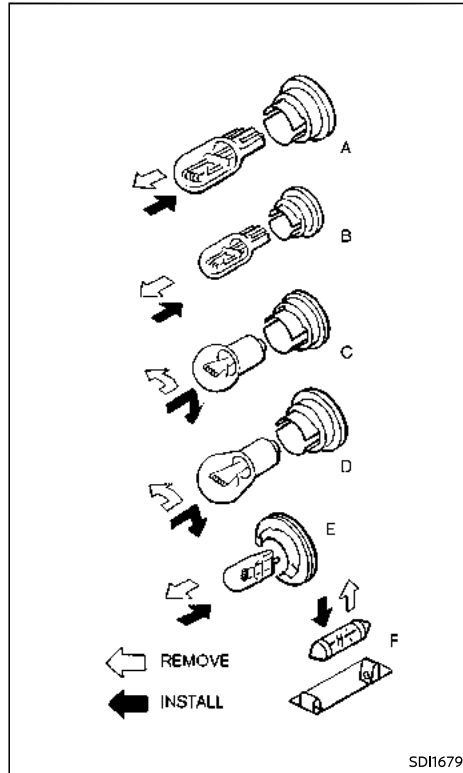

⇨: REMOVE
 ⇩: INSTALL

All other lights are either type A, B, C, D, E or F. When replacing a bulb, first remove the lens and/or cover.

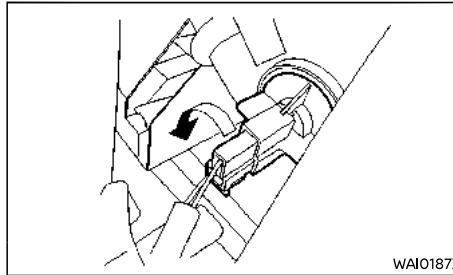

Front turn signal light (halogen headlight model)

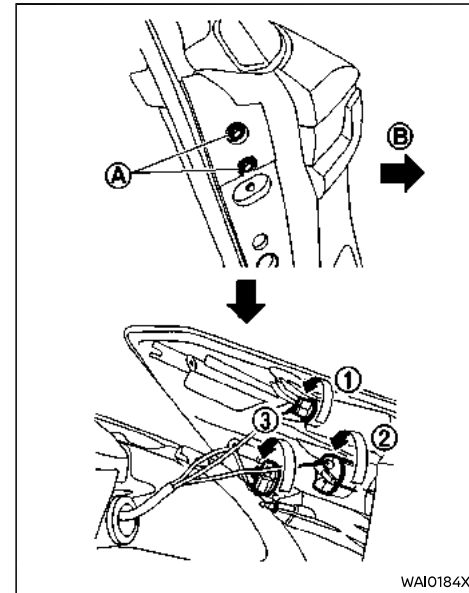

Rear combination light

To replace the rear combination light bulbs:

1. Open the back door.
2. Remove the bolts A and move the rear combination light B as shown to make a clearance, then carefully pry the light using a suitable tool.
3. Replace the bulbs. (Tail light ①, Turn signal light ②, Stop/Tail light ③)
4. Install the combination light in the reverse order of removal.

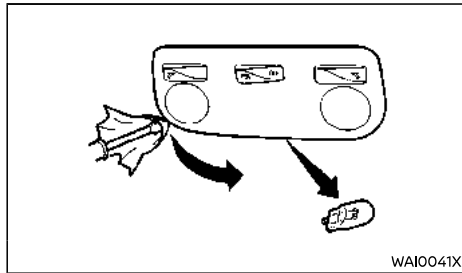

Map light

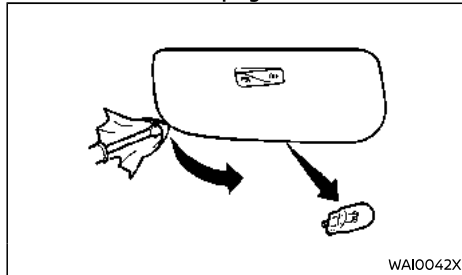

Room light

TIRES AND WHEELS

If you have a flat tire, see "Flat tire" (P.6-2).

TIRE PRESSURE MONITORING SYSTEM (TPMS) (if equipped)

The Tire Pressure Monitoring System (TPMS) monitors tire pressure of all tires except the spare. When the low tire pressure warning light is lit and the tire pressure low telltale (if equipped) appears in the vehicle information display, one or more of your tires is significantly under-inflated.

The TPMS will activate only when the vehicle is driven at speeds above 25 km/h (16 MPH). Also, this system may not detect a sudden drop in tire pressure (for example a flat tire while driving).

For more details about the TPMS, see "Tire Pressure Monitoring System (TPMS)" (P.5-3).

For additional information, see "Low tire pressure warning light" (P.2-11).

TIRE INFLATION PRESSURE

Periodically check the pressure of the tires, including the spare. An incorrect tire pressure may adversely affect tire life and vehicle handling. The tire pressure should be checked when tires are COLD. Tires are considered COLD after the vehicle has been parked for 3 or more hours, or driven less than 1.6 km (1 mile). COLD tire pressures are shown on the tire placard.

Insufficient pressure can lead to an overheating of the tire and subsequent internal damage. At high speeds, this could result in tread separation and even bursting of the tire.

TYPES OF TIRES



CAUTION:

When changing or replacing tires, be sure all four tires are of the same type (that is, summer, all season or snow) and construction. A NISSAN dealer may be able to help you with information about tire type, size, speed rating and availability.

Replacement tires may have a lower speed rating than the factory equipped tires, and they may not match the potential maximum vehicle speed. Never exceed the maximum speed rating of the tire.

All season tires

NISSAN specifies all season tires on some models to provide good performance all year, including snowy and icy road conditions. All season tires are identified by ALL SEASON and/or M&S on the tire sidewall. Snow tires have better snow traction than all season tires and may be more appropriate in some areas.

Summer tires

NISSAN specifies summer tires on some models to provide superior performance on dry roads. Summer tire performance is substantially reduced in snow and ice. Summer tires do not have the tire traction rating M&S on the tire sidewall.

If you plan to operate your vehicle in snowy or icy conditions, NISSAN recommends the use of snow or all season tires on all four wheels.

Snow tires

If snow tires are needed, it is necessary to select tires equivalent in size and load rating to the original equipment tires. If you do not, it can adversely affect the safety and handling of your vehicle.

Generally, snow tires have lower speed ratings than factory equipped tires and may not match the potential maximum vehicle speed. Never exceed the maximum speed rating of the tire. If you install snow tires, they must be the same size, brand, construction and tread pattern on all four wheels.

For additional traction on icy roads, studded tires may be used. However, some states and provinces prohibit their use. Check local, state and provincial laws before installing studded tires. Skid and traction capabilities of studded snow tires on wet or dry surfaces may be poorer than that of non-studded snow tires.

TIRE CHAINS

Use of tire chains may be prohibited according to location. Check the local laws before installing tire chains. When installing tire chains, make sure that they are of proper size for the tires on your vehicle and are installed according to the chain manufacturer's instructions.

Use chain tensioners when recommended by the tire chain manufacturer to ensure a tight fit. Loose end links of the tire chains must be secured or removed to prevent the possibility of whipping action damage to the fenders or underbody. If possible, avoid fully loading your vehicle when using tire chains. In addition, drive at a reduced speed. Otherwise, your vehicle may be damaged and/or vehicle handling and performance may be adversely affected.

Tire chains must be installed only on the front wheels and not on the rear wheels. Do not use the chains on dry roads.

Never install tire chains on the temporary-use spare tire (if equipped).

Do not drive with tire chains on paved roads which are clear of snow. Driving with chains in such conditions can cause damage to the various mechanisms of the vehicle due to some overstress.

TIRE ROTATION

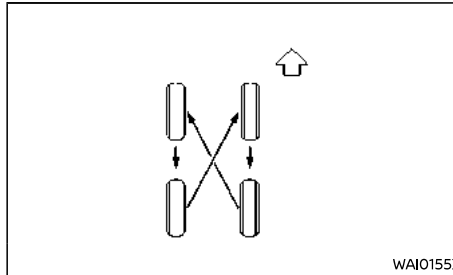

NISSAN recommends that tires be rotated every 10,000 km (6,000 miles). However, the timing for tire rotation may vary according to your driving habits and the road surface conditions. (For the tire replacement, see "Flat tire" (P.6-2).)

WARNING:

- **After rotating the tires, adjust the tire pressure.**
- **Retighten the wheel bolts when the vehicle has been driven for 1,000 km (600 miles) (also in cases of a flat tire, etc.).**

- **Do not include the temporary-use spare tire (if equipped) in tire rotation.**
- **Incorrect tire selection, fitting, care, or maintenance can affect vehicle safety with risk of accident and injury. If in doubt, consult a NISSAN dealer or the tire manufacturer.**

For models equipped with Tire Pressure Monitoring System (TPMS)

After the tires are rotated, the TPMS must be reset to the new tire positions. Visit nearest NISSAN dealer for resetting the tire position.

TIRE WEAR AND DAMAGE

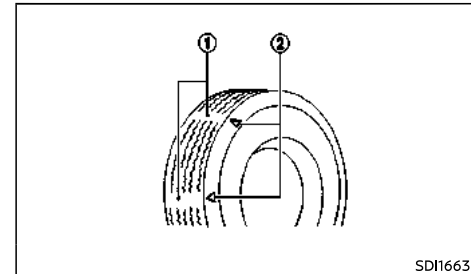

- ① Wear indicator
- ② Wear indicator location marks. The locations are shown by "Δ", "TWI", etc. depending on tire types.

Tires should be periodically inspected for wear, cracking, bulging or objects caught in the tread. If excessive wear, cracks, bulging or deep cuts are found, the tire should be replaced immediately.

The original tires have a built-in tread wear indicator. When the wear indicator is visible, the

tire should be replaced.

Improper service of a spare tire may result in serious personal injury. If it is necessary to repair the spare tire, contact a NISSAN dealer.

TIRE AGE

Never use a tire over six years old, regardless of whether it has been used or not.

Tires degrade with age as well as with the vehicle usage. Have your tires checked and balanced often by a repair shop or, if you prefer, a NISSAN dealer.

CHANGING TIRES AND WHEELS



WARNING:

Do not install a deformed wheel or tire even if it has been repaired. Such wheels or tires could have structural damage and could fail without warning.

When replacing a tire, use the same size, speed rating and load carrying capacity as originally equipped. (For recommended types and sizes of tires and wheels, see "Tires and wheels" (P.9-6).) The use of tires other than those recommended or the mixed use of tires of different brands, construction (bias, bias-belted, or radial), or tread patterns can adversely affect the ride, braking, handling, ground clearance, body-to-tire clearance, snow chain clearance, Tire Pressure Monitoring System (TPMS) (if equipped), speedometer calibration, headlight aim and bumper height. Some of these effects may lead to accidents and could result in serious personal injury.

If the wheels are changed for any reason, always replace with wheels which have the same offset dimension. Wheels of a different offset could cause early tire wear, possibly

degraded vehicle handling characteristics and/or interference with the brake discs/drums. Such interference can lead to decreased braking efficiency and/or early brake pad/shoe wear.

Confirm the following for the TPMS (if equipped):



WARNING:

- **Since the spare tire is not equipped with the TPMS, when a spare tire is mounted or a wheel is replaced, the TPMS will not function and the low tire pressure warning light will flash for approximately 1 minute. The light will remain on after 1 minute. Contact a NISSAN dealer as soon as possible for tire replacement and/or system resetting.**
- **Replacing tires with those not originally specified by NISSAN could affect the proper operation of the TPMS.**
- **The TPMS sensor may be damaged if it is not handled correctly. Be careful when handling the TPMS sensor.**
- **When replacing the TPMS sensor, the ID registration may be required. Contact a NISSAN dealer for ID registration.**

WHEEL BALANCE

Unbalanced wheels may affect vehicle handling and tire life. Even with regular use, wheels can get out of balance. Therefore, they should be balanced as required.

SPARE TIRE

The spare tire supplied with your vehicle varies depending on the model. See "Tires and wheels" (P.9-6) for applicable spare tire.

Temporary-use spare tire (if equipped)

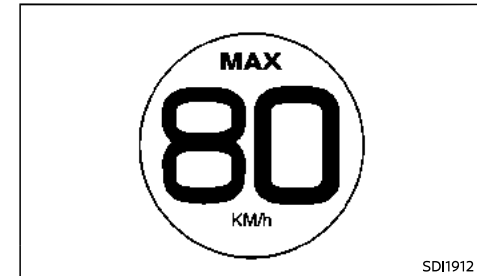

(if equipped)

A temporary-use spare tire (different size from the original tire) is supplied with your vehicle.

Observe the following precautions if the spare tire must be used, otherwise your vehicle could be damaged or involved in an accident.

Since the spare tire is not equipped with the Tire Pressure Monitoring System (TPMS) (if equipped), when a spare tire is mounted, the TPMS will not function.



CAUTION:

- **The spare tire should be used only for emergency. It should be replaced by the standard tire at the first opportunity.**
- **Drive carefully while the spare tire is installed.**
- **Avoid sharp turns and abrupt braking while driving.**

- **Do not drive your vehicle at speeds faster than 80 km/h (50 MPH).**
- **Do not use tire chains on a spare tire. Tire chains will not fit properly on the spare tire and may cause damage to the vehicle.**
- **When driving on roads covered with snow or ice, the spare tire should be used on the rear wheel and the original tire used on the front wheels (drive wheels). Use tire chains only on the front two original tires.**
- **Because the spare tire is smaller than the original tire, ground clearance is reduced. To avoid damage to the vehicle do not drive over obstacles. Also do not drive the vehicle through an automatic car wash since it may get caught.**
- **Do not use the spare tire on other vehicles.**
- **Do not use more than one spare tire at the same time.**

Conventional spare tire (if equipped)

A standard tire (the same size as the original tire) is supplied with your vehicle.

MEMO

9 Technical information

Recommended fluids/lubricants and capacities	9-2	Vehicle Identification Number (VIN)	9-7
Fuel information	9-4	Vehicle Identification Number (VIN) plate	
Recommended SAE viscosity number	9-4	(if equipped)	9-7
Air conditioner system refrigerant and lubricant	9-5	Engine serial number	9-7
Engine	9-5	Tire placard	9-8
Tires and wheels	9-6	Installation of an RF transmitter	9-8
Dimensions	9-6	Radio approval number and information	9-8
When travelling or registering in another country	9-7	For South Africa	9-8
Vehicle identification	9-7	For Indonesia	9-9
Vehicle identification label (if equipped)	9-7		



RECOMMENDED FLUIDS/ LUBRICANTS AND CAPACITIES

The following are approximate capacities. The actual refill quantities may be slightly different. When refilling, follow the procedures instructed in the "8. Maintenance and do-it-yourself" section to determine the proper refill capacity.

Fluid type			Capacity (approximate)			Recommended Fluids/Lubricants
			Metric Measure	US Measure	Imperial Measure	
Fuel			40 L	10-5/8 gal	8-3/4 gal	· See "Fuel information" (P.9-4).
Engine oil* Drain and refill*: For additional information, see "Changing engine oil and oil filter" (P.8-8).	BR10 HS	Without oil filter change	2.48 L	2-5/8 qt	2-1/8 qt	<ul style="list-style-type: none"> · Genuine "NISSAN Motor Oil 10W-30 SM or SN" is recommended. · If the above motor oil is not available, use "NISSAN Motor Oil" or equivalent that matches the following grade and viscosity. <ul style="list-style-type: none"> · Oil grade: <ul style="list-style-type: none"> – API SM or SN, ILSAC GF-4 or GF-5 – ACEA:A3/B4 · SAE Viscosity: See "Recommended SAE viscosity number" (P.9-4).
		With oil filter change	2.91 L	3-1/8 qt	2-5/8 qt	
	HRA0-DET	Without oil filter change	3.2 L	3-3/8 qt	2-7/8 qt	
		With oil filter change	3.4 L	3-5/8 qt	3 qt	
Engine coolant (with reservoir)	BR10 HS	4.7 L	5 qt	4-1/8 qt	<ul style="list-style-type: none"> · Genuine NISSAN Engine Coolant (blue) or equivalent · Use Genuine NISSAN Engine Coolant or equivalent in its quality, in order to avoid possible aluminum corrosion within the engine cooling system caused by the use of non-genuine engine coolant. · Note that any repairs for the incidents within the engine cooling system while using non-genuine engine coolant may not be covered by the warranty even if such incidents occurred during the warranty period. 	
	HRA0DET	5.95 L	6-1/4 qt	5-1/4 qt		
Continuously Variable Transmission (CVT) fluid			6.9 L	7-1/4 qt	6-1/8 qt	<ul style="list-style-type: none"> · Genuine NISSAN CVT Fluid NS-3 · Use only Genuine NISSAN CVT Fluid NS-3. Using transmission fluid other than Genuine NISSAN CVT Fluid NS-3 will damage the CVT. Such damage is not covered by the warranty. · Contact a NISSAN dealer or qualified workshop for details or servicing.
Manual Transmission (MT) gear oil			—	—	—	BR10 HS engine model <ul style="list-style-type: none"> · Manual Transmission Fluid (MTF) TRANSELF NFP 75W-80 or equivalent · If Manual Transmission Fluid (MTF) TRANSELF NFP is not available, API GL-4, Viscosity SAE 75W-80 may be used as a temporary replacement. However, use Manual Transmission Fluid (MTF) TRANSELF NFP as soon as it is available.
						HRA0DET engine model <ul style="list-style-type: none"> · Genuine NISSAN Manual Transmission Fluid (MTF) HQ Multi 75W-85 or equivalent · If Genuine NISSAN Manual Transmission Fluid (MTF) HQ Multi is not available, API GL-4, Viscosity SAE 75W-85 may be used as a temporary replacement. However, use Genuine NISSAN Manual Transmission Fluid (MTF) HQ Multi as soon as it is available.

9-2 Technical information

Fluid type	Capacity (approximate)			Recommended Fluids/Lubricants
	Metric Measure	US Measure	Imperial Measure	
Brake and clutch fluid	Refill to the proper fluid level according to the instructions in the "8. Maintenance and do-it-yourself" section.			Genuine NISSAN Brake Fluid or equivalent DOT4
Multi-purpose grease	—	—	—	· NLGI No. 2 (Lithium soap base)
Air conditioner system refrigerant	—	—	—	· HFC-134a (R-134a)
Air conditioner system lubricants	—	—	—	· SP-10 or equivalent

FUEL INFORMATION

Gasoline engine



CAUTION:

Do not use leaded gasoline. Using leaded gasoline will damage the three-way catalyst.

BR10 HS engine model:

Use UNLEADED REGULAR gasoline with an octane rating of at least 91 (RON).

HRAODET engine model:

Except for Sri Lanka:

Use UNLEADED REGULAR gasoline with an octane rating of at least 91 (RON).

For Sri Lanka:

Use UNLEADED PREMIUM gasoline with an octane rating of at least 95 (RON).

If unleaded premium gasoline is not used, UNLEADED REGULAR gasoline with an octane rating of at least 91 (RON) or above may be temporarily used, but only under the following precautions:

- Have the fuel tank filled only partially with unleaded regular gasoline, and fill up with unleaded premium gasoline as soon as possible.
- Avoid full throttle driving and abrupt acceleration.

Use unleaded premium gasoline for maximum vehicle performance.

RECOMMENDED SAE VISCOSITY NUMBER

For BR10 HS engine model
10W-30 is preferable.

If 10W-30 is not available, select the viscosity, from the chart below, that is suitable for the outside temperature range.

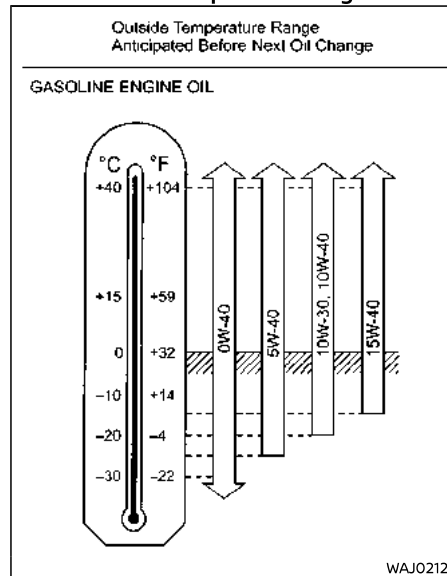

For HRAODET engine model

0W-20 is preferable.

If 0W-20 is not available, select the viscosity, from the chart below, that is suitable for the outside temperature range.

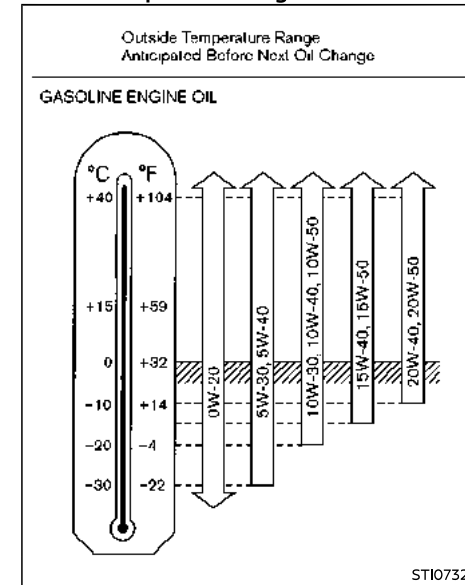

ENGINE

AIR CONDITIONER SYSTEM REFRIGERANT AND LUBRICANT

The air conditioner system of your vehicle must be charged with the refrigerant HFC-134a (R-134a) and the lubricant SP-10 or equivalents. Use of any other refrigerants or lubricants will cause severe damage, and you may need to replace your vehicle's entire air conditioner system.

The release of refrigerants into the atmosphere is prohibited in many countries and regions. The refrigerant HFC-134a (R-134a) in your vehicle will not harm the Earth's ozone layer. However, it may contribute in a small part to the global warming effect. NISSAN recommends that the refrigerant be appropriately recovered and recycled. Contact a NISSAN dealer when servicing the air conditioner system.

Engine model		BR10 HS	HRA0DET
Type		Gasoline, 4-cycle, DOHC	Gasoline, 4-cycle, DOHC with Turbocharger
Cylinder arrangement		3-cylinder, in-line	3-cylinder, in-line
Bore × Stroke	mm (in)	71 × 84.1 (2.795 × 3.311)	72.2 × 81.3 (2.843 × 3.201)
Displacement	cm ³ (cu in)	999 (60.96)	999 (60.96)
Idle speed at the "N" (Neutral) position	rpm	800 ± 50	CVT: 800 ± 50 MT: 850 ± 50
Ignition timing (B.T.D.C.) at the "N" (Neutral) position	degree at idle	1 ± 5°	CVT: 4 ± 2° MT: 6 ± 2°
Spark plugs			
	Type	REA8MC	ILKAR7Q7
	Gap	mm (in)	0.9 ± 0.05 (0.035 ± 0.001) 0.6 to 0.7 (0.024 to 0.028)
Camshaft operation		Timing chain	Timing chain

TIRES AND WHEELS

Tire size	
Standard	195/60R16 89V
	195/60R16 89H
Spare	195/60R16 89V
	195/60R16 89H
	185/65 R15 88R*

*: For temporary use only.

		Size	Offset mm (in)
Road wheel	Steel	16 x 5.5J	30 (1.18)
	Aluminum	16 x 5.5J	30 (1.18)
Spare	Steel	15 x 5J	25 (0.98)
	Steel	16 x 5.5J	30 (1.18)

For India: Tires & tubes fitted in the vehicle, as per clause 3(c) & 3(e) meet the requirement of BIS and comply with the requirements under the Central Motor Vehicle Rules (CMVR), 1989.

DIMENSIONS

Unit: mm (in)	
Overall length	3,994 (157.24)
Overall width	1,758 (69.21)
Overall height (including roof rack)	1,572 (61.89)
Front tread	1,536 (60.47)
Rear tread	1,535 (60.43)
Wheelbase	2,500 (98.43)

WHEN TRAVELLING OR REGISTERING IN ANOTHER COUNTRY

When planning to travel in another country or region, find out whether the fuel required for your vehicle is available in that country or region. Using a low octane rated fuel may cause engine damage. Therefore, be sure that the required fuel is available wherever you go. For additional information regarding recommended fuel, see earlier in this section.

When transferring the registration of your vehicle to another country, state, province or district, contact the appropriate authorities to find out that the vehicle complies with the local legal requirements. In some cases, a vehicle cannot meet the legal requirements, and it may be necessary to modify the vehicle to meet local laws and regulations. In addition, there may be possibilities that a vehicle cannot be adapted in certain areas.

The laws and regulations for motor vehicle emission control and safety standards vary according to the country, state, province or district; therefore, the vehicle specification may differ.

When any vehicles are to be taken into another country, state, province or district, its modification, transportation, registration, and any other expenses which may result, are the responsibility of the user. NISSAN is not responsible for any inconveniences that may result.

VEHICLE IDENTIFICATION

It is prohibited to cover, paint, weld, cut, drill, alter or remove Vehicle Identification Number (VIN).

VEHICLE IDENTIFICATION LABEL (if equipped)

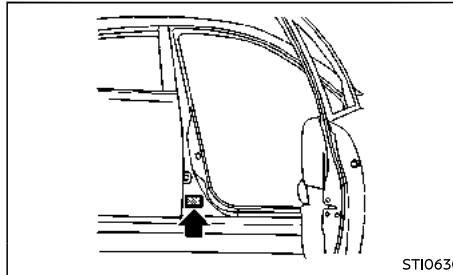

The vehicle identification label is affixed as shown.

VEHICLE IDENTIFICATION NUMBER (VIN)

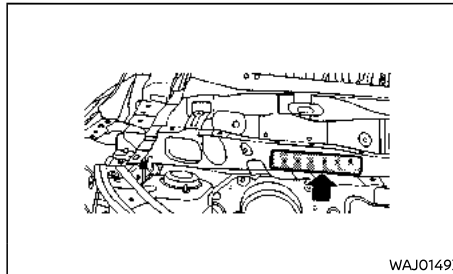

The vehicle identification number is located as shown.

VEHICLE IDENTIFICATION NUMBER (VIN) PLATE (if equipped)

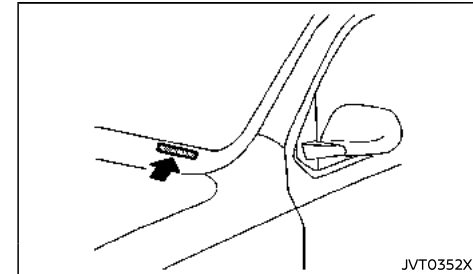

The vehicle identification number plate is attached as shown.

ENGINE SERIAL NUMBER

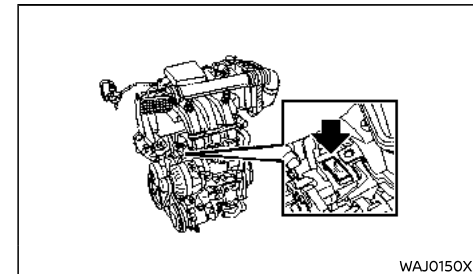

BR10 HS engine

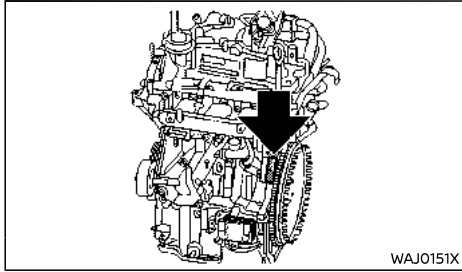

HRAODET engine

The engine serial number is attached/stamped on the engine as shown.

TIRE PLACARD

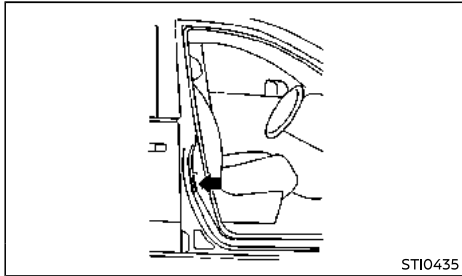

The cold tire pressures are shown on the tire placard affixed to the driver's side center pillar.

INSTALLATION OF AN RF TRANSMITTER

For countries conforming to UN regulation No.10 or equivalent:

The installation of an RF transmitter in your vehicle could affect electric equipment systems. Be sure to check with your NISSAN dealer for precautionary measures or special instructions regarding installation. Upon request, your NISSAN dealer will provide the detailed information (frequency band, power, antenna position, installation guide, etc.) regarding installation.

RADIO APPROVALNUMBER AND INFORMATION

FOR SOUTH AFRICA

Intelligent Key system (transmitter)



Tire Pressure Monitoring System (TPMS) transmitter

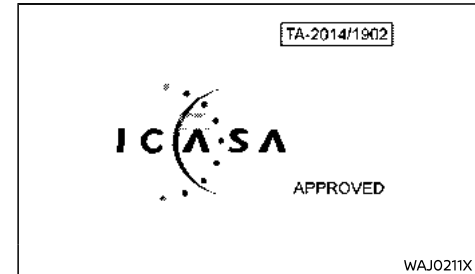

FOR INDONESIA

Remote keyless entry system (if equipped)



Intelligent Key system (transmitter)



MEMO

9-10 **Technical information**

10 Index

A

ABS (Anti-lock Braking System).....	5-24
Aiming control, Headlights.....	2-21
Air bag system	
Air bag warning labels.....	1-21
Supplemental front-impact air bag system.....	1-19, 1-23
Air cleaner filter.....	8-14
Air conditioner	
Air conditioner operation.....	4-14
Air conditioner service.....	4-18
Air conditioning system refrigerant and lubricant recommendations.....	4-18
Air fresheners.....	7-4
Antenna.....	4-37
Anti-lock Braking System (ABS).....	5-24
Anti-lock Braking system (ABS) warning light.....	2-10
Appearance care	
Exterior appearance care.....	7-2
Interior appearance care.....	7-3
Armrest.....	1-4
Around View Monitor.....	4-7
Audible reminders.....	2-14
Audio system.....	4-19, 4-31
Automatic air conditioner.....	4-17
Automatic Collision Notification (ACN).....	1-25

B

Back door.....	3-15
Battery.....	8-3, 8-17
Battery disposal.....	-2
Battery replacement, Intelligent Key.....	8-18
Battery replacement, Remote controller.....	8-17
Bluetooth® Hands-Free Phone.....	4-24, 4-35
Brake	
Anti-lock Braking System (ABS).....	5-24

Brake booster.....	8-12
Brake fluid.....	8-12
Brake system.....	5-24
Checking foot brake pedal.....	8-11
Parking brake check.....	8-11
Parking brake operation.....	5-26
Warning light.....	2-10
Break-in schedule.....	5-2
Brightness control, Instrument panel.....	2-8
Bulb check/instrument panel.....	2-10
Bulb replacement.....	8-2, 8-25

C

Canceling cruising speed.....	5-18
Card holder.....	2-26
Cargo cover.....	2-27
Cargo room light.....	2-30
Catalytic converter, Three way catalyst.....	5-3
Checking	
Checking engine coolant level.....	8-7
Checking engine oil level.....	8-8
Checking foot brake pedal.....	8-11
Checking lights.....	2-10
Checking parking brake.....	8-11
Child restraints.....	1-10
Child safety.....	1-8
Child safety rear door lock.....	3-4
Chimes, Audible reminders.....	2-14
Circuit breaker, Fusible link.....	8-20
Cleaning exterior and interior.....	7-2, 7-3
Clock.....	2-18
Clutch fluid.....	8-13
Coat hook.....	2-28
Cockpit.....	2-2
Cold weather driving.....	5-26
Continuously Variable Transmission (CVT) fluid.....	8-14
Continuously Variable Transmission (CVT) position indicator.....	2-8

Coolant

Changing engine coolant.....	8-7
Checking engine coolant level.....	8-7
Coolant temperature warning light.....	2-10
Coolant temperature warning light.....	2-10
Corrosion protection.....	7-5
Cover, Cargo cover.....	2-27
Cruise control.....	5-17
Cup holders.....	2-26

D

Daytime running light system.....	2-20
Defogger switch.....	2-23
Dimensions.....	9-6
Display	
Vehicle information display.....	2-15, 2-18
Door open warning light.....	2-11
Drive belt.....	8-10
Driving	
Cold weather driving.....	5-26
Driving with Continuously Variable Transmission (CVT).....	5-10
Driving with Manual Transmission (MT).....	5-13
Precautions when starting and driving.....	5-2

E

Economy, Fuel.....	5-20
Electric power steering warning light.....	2-11
Emergency Stop Signal.....	6-2
Engine	
Break-in schedule.....	5-2
Changing engine coolant.....	8-7
Checking engine coolant level.....	8-7
Checking engine oil level.....	8-8
Coolant temperature gauge.....	2-7
Coolant temperature warning light.....	2-10

Engine compartment	
check locations.....	8-5
Engine cooling system.....	8-6
Engine oil.....	8-8
Engine serial number.....	9-7
Engine specifications.....	9-5
If your vehicle overheats.....	6-8
Exhaust gas (carbon monoxide).....	5-3
Explanation of general	
maintenance items.....	8-2

F

Flat tire.....	6-2
Floor mat cleaning.....	7-4
Fluid	
Brake fluid.....	8-12
Clutch fluid.....	8-13
Continuously Variable Transmission	
(CVT) fluid.....	8-14
Engine coolant.....	8-6
Engine oil.....	8-8
Window washer fluid.....	8-3, 8-16
FM-AM radio with USB connection port....	4-20
Fog light switch.....	2-22
Front fog lights.....	2-22
Front map lights.....	2-30
Front room light.....	2-30
Front seat, Front seat adjustment.....	1-2
Fuel	
Fuel economy.....	5-20
Fuel gauge.....	2-7
Fuel information.....	9-4
Fuel octane rating.....	9-4
Fuel-filler cap.....	3-17
Fuel-filler lid.....	3-17
Fuel Efficiency and Carbon Dioxide	
Reduction driving tips.....	5-19
Fuses.....	8-19
Fusible links.....	8-20

G

Gauge.....	2-4
Engine coolant temperature gauge.....	2-7
Fuel gauge.....	2-7
Speedometer.....	2-5
Tachometer.....	2-6
Trip computer.....	2-19
Trip computer (with color display).....	2-16
General maintenance.....	8-2
Glove box.....	2-26

H

Hands-free phone.....	4-24, 4-35
Hazard indicator flasher switch.....	6-2
Head restraints.....	1-4
Headlights	
Aiming control.....	2-21
Bulb replacement.....	8-25
Headlight switch.....	2-20
Heater	
Heater and air	
conditioner operation.....	4-14
Hill start assist system.....	5-16
Hood release.....	3-14
Horn.....	2-23

I

Ignition switch	
(with Intelligent Key system).....	5-7
(without Intelligent Key system).....	5-6
Key positions.....	5-6
Indicator lights.....	2-13
Instrument brightness control.....	2-8
Instrument panel.....	2-3
Intelligent Key.....	3-2
Intelligent Key system.....	3-6
Key operating range.....	3-7

Interior lights.....	2-30
----------------------	------

J

Jump starting.....	6-7
--------------------	-----

K

Key	
NISSAN Anti-Theft System (NATS) key....	3-2
Keyless entry (See remote keyless	
entry system).....	3-5
Keys.....	3-2
For Intelligent Key system.....	3-6

L

Labels	
Engine serial number.....	9-7
Vehicle identification.....	9-7
Light	
Bulb replacement.....	8-2, 8-25
Fog light switch.....	2-22
Front map lights.....	2-30
Front room light.....	2-30
Headlight switch.....	2-20
Headlights bulb replacement.....	8-25
Indicator lights.....	2-13
Interior lights.....	2-30
Rear room light.....	2-30
Replacement.....	8-2, 8-25
Warning/indicator lights and	
audible reminders.....	2-10
Lock	
Back door lock.....	3-15
Vehicle speed sensing door	
lock mechanism.....	3-4
Locking with inside lock knob.....	3-4
Low fuel warning light.....	2-11
Low tire pressure warning light.....	2-11

Low tire pressure warning system (See Tire Pressure Monitoring System (TPMS)).....	5-3
Luggage hooks.....	2-28

M

Maintenance	
Battery.....	8-3, 8-17
Explanation of general maintenance items.....	8-2
General maintenance.....	8-2
Maintenance precautions.....	8-3
Maintenance requirements.....	8-4
Seat belt maintenance.....	1-10
Maintenance free battery.....	8-17
Malfunction Indicator Light.....	2-13
Manual air conditioner.....	4-15
Manual Transmission (MT).....	5-6
Mechanical key (Intelligent Key system).....	3-3
Meter	
Trip computer.....	2-19
Trip computer (with color display).....	2-16
Meters and gauges.....	2-4
Instrument brightness control.....	2-8
Mirror, Vanity mirror.....	3-19
Monitor, Around View Monitor.....	4-7
Monitor, Rear view monitor.....	4-2
Multimedia system.....	4-31

N

New vehicle break-in.....	5-2
NISSAN Anti-Theft System (NATS) key.....	3-2

O

Oil	
Checking engine oil level.....	8-8
Engine oil.....	8-8
Outside air temperature.....	2-18

Overheat, If your vehicle overheats.....	6-8
--	-----

P

Parking	
Brake break-in.....	5-24
Parking brake operation.....	5-26
Parking sensor system.....	5-22
Phone.....	4-24, 4-35
Power	
Power outlet.....	2-25
Power steering.....	5-23
Power windows.....	2-24
Pre-tensioner seat belt system.....	1-20, 1-24
Precautions	
Maintenance.....	8-3
Seat belt usage.....	1-6
Supplemental restraint system.....	1-19
Towing precautions.....	6-9
When starting and driving.....	5-2
Precautions on cruise control.....	5-17
Push starting.....	6-8
Push-button ignition switch.....	5-7

R

Radio.....	4-21, 4-34
Rear door lock, Child safety rear door lock.....	3-4
Rear room light.....	2-30
Rear seats.....	1-3
Rear view monitor.....	4-2
Rear window wiper and washer switch....	2-23
Remote keyless entry system.....	3-5
Roof, Roof rack.....	2-29

S

Safety, Child seat belts.....	1-8
Seat adjustment, Front seats.....	1-2

Seat belt(s)	
Child safety.....	1-8
Injured persons.....	1-9
Pre-tensioner seat belt system.....	1-20, 1-24
Precautions on seat belt usage.....	1-6
Pregnant women.....	1-8
Seat belt cleaning.....	7-4
Seat belt maintenance.....	1-10
Seat belt warning light.....	2-12
Seat belts.....	1-6
Seat(s), Seats.....	1-2
Security system.....	3-13
Service reminder.....	2-17
Setting cruising speed.....	5-18
Shift lever	
Shift lock release.....	5-12
Shift lock release Transmission.....	5-12
Smartphone integration.....	4-36
Sonar system.....	5-22
Spare tire.....	8-30
Spark plugs.....	8-11
Speedometer.....	2-5
SPORT mode switch.....	5-12
SRS air bag warning light.....	1-21
Starting	
Jump starting.....	6-7
Precautions when starting and driving.....	5-2
Push starting.....	6-8
Steering	
Power steering.....	5-23
Steering lock.....	5-6, 5-7
Tilting steering wheel.....	3-17
Sun visors.....	2-29
Supplemental front-impact air bag system.....	1-23
Switch	
Fog light switch.....	2-22
Headlight aiming control.....	2-21
Headlight switch.....	2-20

Power door lock switch	3-4
SPORT mode switch.....	5-12
Turn signal switch	2-21

T

Tachometer.....	2-6
Temperature gauge, Engine coolant	
temperature gauge.....	2-7
Three-way catalyst.....	5-3
Tilting steering wheel.....	3-17
Tire	
Pressure, Low tire pressure	
warning light.....	2-11
Tires	
Flat tire.....	6-2
Low tire pressure warning system	5-3
Tire chains.....	8-29
Tire Pressure Monitoring	
System (TPMS).....	5-3, 6-2
Tire rotation.....	8-2, 8-29
Tires and wheels.....	8-28, 9-6
Types of tires.....	8-28
Tonneau cover (see cargo cover).....	2-27
Towing	
Tow truck towing.....	6-9
Towing precautions	6-9
Towing your vehicle.....	6-9
TPMS, Tire Pressure	
Monitoring System.....	5-3, 6-2
Transmission	
Continuously Variable Transmission	
(CVT) fluid.....	8-14
Driving with Manual	
Transmission (MT).....	5-13
Transmission shift lever lock release.....	5-12
Transmitter (See remote keyless	
entry system).....	3-5
Trip computer.....	2-19
Trip computer (with color display).....	2-16

Turn signal switch.....	2-21
-------------------------	------

U

Underbody cleaning.....	7-3
-------------------------	-----

V

Vanity mirror.....	3-19
Vehicle	
Dimensions.....	9-6
Speed sensing door lock mechanism....	3-4
Vehicle identification	9-7
Vehicle Dynamic Control (VDC)	
OFF switch.....	5-15
Vehicle Dynamic Control (VDC) system....	5-15
Vehicle Dynamic Control (VDC)	
warning light.....	2-13
Vehicle Identification Number (VIN).....	9-7
Vehicle information display.....	2-15, 2-18
Ventilators.....	4-13

W

Warning	
Lights.....	2-10
Tire Pressure Monitoring	
System (TPMS).....	5-3, 6-2
Warning lights, indicator lights and	
audible reminders.....	2-9
Warning light	
Anti-lock braking system (ABS)	
warning light.....	2-10
Brake warning light.....	2-10
Door open warning light.....	2-11
Low fuel warning light	2-11
Low tire pressure warning light.....	2-11
Seat belt warning light.....	2-12
Vehicle Dynamic Control (VDC)	
warning light.....	2-13

Washer switch	
Rear window wiper and	
washer switch.....	2-23
Washer switch, Windshield wiper and	
washer switch.....	2-22
Washing.....	7-2
waxing.....	7-2
Wheels and tires	
Care of wheels.....	7-3
Cleaning aluminum alloy wheels.....	7-3
Window washer fluid	8-3, 8-16
Window(s)	
Cleaning.....	7-2, 7-4
Power windows	2-24
Windshield wiper and washer switch.....	2-22
Wiper	
Rear window wiper and	
washer switch.....	2-23
Rear window wiper blade.....	8-15
Windshield wiper and	
washer switch.....	2-22
Wiper blades.....	8-15

MEMO

GAS STATION INFORMATION

FUEL INFORMATION

Gasoline engine



CAUTION:

Do not use leaded gasoline. Using leaded gasoline will damage the three-way catalyst.

BR10 HS engine model:

Use UNLEADED REGULAR gasoline with an octane rating of at least 91 (RON).

HRAOJET engine model:

Except for Sri Lanka:

Use UNLEADED REGULAR gasoline with an octane rating of at least 91 (RON).

For Sri Lanka:

Use UNLEADED PREMIUM gasoline with an octane rating of at least 95 (RON).

If unleaded premium gasoline is not used, UNLEADED REGULAR gasoline with an octane rating of at least 91 (RON) or above may be temporarily used, but only under the following precautions:

- **Have the fuel tank filled only partially with unleaded regular gasoline, and fill up with unleaded premium gasoline as soon as possible.**
- **Avoid full throttle driving and abrupt acceleration.**

Use unleaded premium gasoline for maximum vehicle performance.

RECOMMENDED ENGINE OIL

See "Recommended fluids/lubricants and capacities" (P.9-2).

TIRE COLD PRESSURE

See the tire placard affixed to the driver's side center pillar.

QUICK REFERENCE

- In case of emergency ... 6-1
(Flat tire, engine will not start, overheating, towing)
- How to start the engine ... 5-1
- How to read the meters and gauges ... 2-1
- Maintenance and do-it-yourself ... 8-1
- Technical information ... 9-1

Printing: October 2020
Publication No.: OM20E00DD0G0
Printed in India
T00UM-6VA1E

DD0-A