



BMW Motorrad



Rider's manual

**R 1250 GS Adventure**

## Vehicle data/dealership details

### Vehicle data

---

Model

---

Vehicle Identification Number

---

Colour code

---

Date of first registration

---

Registration number

### Dealership details

---

Person to contact in Service department

---

Ms/Mr

---

Phone number

---

Dealership address/phone number (company stamp)

## Welcome to BMW

We congratulate you on your choice of a vehicle from BMW Motorrad and welcome you to the community of BMW riders. Familiarise yourself with your new vehicle so that you can ride it safely and confidently in all traffic situations.

### About this Rider's Manual

Please read this Rider's Manual carefully before starting to use your new BMW. It contains important information on how to operate the controls and how to make the best possible use of all your BMW's technical features. In addition, it contains information on maintenance and care to help you maintain your vehicle's reliability and safety, as well as its value.

This record of the maintenance work you have had performed on

your vehicle is a precondition for generous treatment of goodwill claims.

If the time comes to sell your BMW, please remember to hand over this Rider's Manual to the new owner. It is an important part of the vehicle.

### Suggestions and criticism

If you have questions concerning your vehicle, your authorised BMW Motorrad dealer will gladly provide advice and assistance.

We hope you will enjoy riding your BMW and that all your journeys will be pleasant and safe

BMW Motorrad.

01 40 9 446 661



# Table of Contents

<b>1 General instructions ....</b>	<b>5</b>	<b>3 Status indicators .....</b>	<b>27</b>	Traction control (ASC/DTC) .....	78
Overview .....	6	Indicator and warning lights .....	28	Electronic Suspension Adjustment (D-ESA) .....	79
Abbreviations and symbols .....	6	TFT display in Pure Ride view .....	30	Riding mode .....	82
Equipment .....	7	TFT display in view menu .....	32	PRO riding mode .....	85
Technical data .....	7	Warnings .....	33	Cruise-control system .....	87
Currentness .....	8	<b>4 Operation.....</b>	<b>61</b>	Hill Start Control .....	89
Additional sources of information.....	8	Ignition switch/steering lock .....	62	Anti-theft alarm (DWA) .....	92
Certificates and operating licences .....	8	Ignition with Keyless Ride .....	64	Tyre pressure monitoring (RDC) .....	95
Data memory.....	8	Emergency off switch (kill switch) .....	68	Heated handlebar grips .....	95
Intelligent emergency call system .....	12	Intelligent emergency call .....	68	Front and rear seats.....	96
<b>2 General views .....</b>	<b>17</b>	Lights .....	71	Stowage compartment .....	99
General view, left side .....	19	Day run lights .....	72	<b>5 TFT display .....</b>	<b>101</b>
General view, right side .....	21	Hazard warning lights system .....	74	General instructions .....	102
Underneath the seat .....	22	Turn indicators .....	75	Principle .....	103
Multifunction switch, left .....	23	Antilock Brake System (ABS).....	76	Pure Ride view .....	109
Multifunction switch, right .....	25			General settings.....	111
Instrument panel .....	26			Bluetooth.....	112
				My vehicle .....	115
				Navigation .....	118
				Media .....	120
				Phone .....	120

Display software version .....	121
Display licence information .....	121
<b>6 Adjustment .....</b>	<b>123</b>
Mirrors .....	124
Headlight .....	125
Windscreen .....	126
Clutch .....	126
Brakes .....	127
Shift mechanism .....	130
Footrests .....	131
Handlebars .....	132
Spring preload .....	132
Damping .....	133
<b>7 Riding .....</b>	<b>135</b>
Safety information .....	136
Comply with checklist .....	138
Always before riding off: .....	139
At every third refuelling stop .....	139
Starting .....	139
Running in .....	142
Off-road use .....	143

Shifting gear .....	144
Brakes .....	145
Parking your motorcycle cycle .....	147
Refuelling .....	148
Securing motorcycle for transportation .....	152
<b>8 Engineering details .....</b>	<b>155</b>
General instructions .....	156
Antilock Brake System (ABS) .....	156
Traction control (ASC/DTC) .....	159
Dynamic ESA .....	161
Riding mode .....	162
Dynamic Brake Control .....	164
Tyre pressure control (RDC) .....	165
Shift assistant .....	167
Hill Start Control .....	168
ShiftCam .....	170

<b>9 Maintenance .....</b>	<b>171</b>
General instructions .....	172
Tool kit .....	172
Service tool kit .....	173
Front-wheel stand .....	173
Engine oil .....	174
Brake system .....	176
Clutch .....	180
Coolant .....	180
Tyres .....	181
Rims and tyres .....	182
Wheels .....	182
Air filter .....	189
Lighting .....	191
Jump-starting .....	193
Battery .....	194
Fuses .....	198
Diagnostic connector .....	200
<b>10 Accessories .....</b>	<b>203</b>
General instructions .....	204
Power sockets .....	204
Cases .....	205
Topcase .....	207
Navigation system .....	209

<b>11 Care .....</b>	<b>215</b>	Electrical system .....	236	Certificate for TFT instrument cluster.....	271
Care products .....	216	Anti-theft alarm.....	237	<b>15 Index .....</b>	<b>274</b>
Washing the vehicle.....	216	Dimensions .....	238		
Cleaning easily damaged components.....	217	Weights .....	240		
Care of paintwork .....	218	Riding specifications .....	240		
Vehicle preservation.....	218	<b>13 Service .....</b>	<b>241</b>		
Laying up the motorcycle .....	219	BMW Motorrad Service ...	242		
Restoring motorcycle to use .....	219	BMW Motorrad Service history.....	242		
<b>12 Technical data .....</b>	<b>221</b>	BMW Motorrad Mobility services .....	243		
Troubleshooting chart .....	222	Maintenance work.....	243		
Screw connections .....	225	BMW Service .....	243		
Fuel .....	228	Maintenance schedule .....	247		
Engine oil .....	229	Maintenance confirmations.....	248		
Engine .....	229	Service confirmations .....	262		
Clutch .....	230	<b>14 Appendix.....</b>	<b>265</b>		
Transmission .....	231	Certificate for electronic immobiliser .....	266		
Rear-wheel drive .....	231	Certificate for Keyless Ride .....	268		
Frame .....	232	Certificate for tyre pressure control (RDC) .....	270		
Chassis and suspension .....	232				
Brakes .....	233				
Wheels and tyres.....	234				

## General instructions

Overview .....	6
Abbreviations and symbols .....	6
Equipment .....	7
Technical data .....	7
Currentness .....	8
Additional sources of information ....	8
Certificates and operating licences .....	8
Data memory .....	8
Intelligent emergency call system .....	12

## Overview

An important aspect of this Rider's Manual is that it can be used for quick and easy reference. Consulting the extensive index at the end of this Rider's Manual is the fastest way to find information on a particular topic or item. To first read an overview of your motorcycle, please go to Chapter 2. All maintenance and repair work on the motorcycle is documented in Chapter 12. This record of the maintenance work you have had performed on your vehicle is a precondition for generous treatment of goodwill claims. When the time comes to sell your BMW, please remember to hand over this Rider's Manual; it is an important part of the motorcycle.

## Abbreviations and symbols



**CAUTION** Low-risk hazard. Non-avoidance can lead to slight or moderate injury.



**WARNING** Medium-risk hazard. Non-avoidance can lead to fatal or severe injury.



**DANGER** High-risk hazard. Non-avoidance leads to fatal or severe injury.





**ATTENTION** Special notes and precautionary measures. Non-compliance can lead to damage to the vehicle or accessory and, consequently, to voiding of the warranty.



**NOTICE** Specific instructions on how to operate, control, adjust or look after items of equipment on the vehicle.



Indicates the end of an item of information.

- Instruction.
- » Result of an activity.
- ➡ Reference to a page with more detailed information.
- ◁ Indicates the end of a passage relating to specific accessories or items of equipment.
-  Tightening torque.
-  Technical data.
- NV National-market version.



OE Optional extras.  
The vehicles are assembled complete with all the BMW Motorrad optional extras originally ordered.

OA Optional accessories.  
You can obtain BMW Motorrad optional accessories through your authorised BMW Motorrad dealer; optional accessories have to be retrofitted to the vehicle.

ABS Anti-lock brake system.

ASC Automatic Stability Control.

D-ESA Electronic chassis and suspension adjustment.

DTC Dynamic Traction Control (optional extra only in combination with Pro riding modes).

DWA Anti-theft alarm (Diebstahlwarnanlage).

EWS Electronic immobiliser.

RDC Tyre pressure monitoring.

## Equipment

When purchasing your BMW motorcycle, you chose a model with individual equipment. This rider's manual describes optional equipment (OE) and selected optional accessories (OA) provided by BMW. Please make allowance for the fact that some equipment specifications may be described that you have not selected. Equally, country-specific de-

viations to the motorcycle shown are also possible. If your motorcycle has equipment that is not described, you will find the relevant description in a separate manual.

## Technical data

All dimensions, weights and power outputs in the rider's manual refer to the German standard DIN (Deutsches Institut für Normung e. V.) and comply with its specified tolerances. Technical data and specifications in this rider's manual serve as reference points. The vehicle-specific data may deviate from these, for example as a result of selected optional equipment, the national-market version or country-specific measuring procedures. Detailed values can be taken from the vehicle registration documents and signs on the vehicle, or can be

obtained from your authorised BMW Motorrad Retailer or another qualified service partner or specialist workshop. The specifications in the vehicle documents always have priority over the information provided in this rider's manual.

## Currentness

The high safety and quality level of BMW motorcycles is ensured by constant further development in the areas of design, equipment and accessories. This may result in deviations between these operating instructions and your motorcycle. Also, mistakes cannot be completely excluded by BMW Motorrad. Please therefore understand that we do not accept any liability for claims arising from incorrect information, drawings and descriptions.

## Additional sources of information

### BMW Motorrad Retailer

Your BMW Motorrad Retailer will be happy to answer any questions you may have.

### Internet

The rider's manual for your vehicle, operating and installation instructions for any accessories and general information on BMW Motorrad, for example relating to technology, are available at **[www.bmw-motorrad.com/service](http://www.bmw-motorrad.com/service)**.

## Certificates and operating licences

The certificates for the vehicle and the official operating licences for any accessories are available at **[www.bmw-motorrad.com/certification](http://www.bmw-motorrad.com/certification)**.

## Data memory

### General

Control units are installed in the vehicle. Control units process data that they receive, for example, from vehicle sensors, or that they generate themselves or exchange between each other. Some control units are required for the vehicle to function safely or provide assistance during riding, for example assistance systems. In addition, control units enable comfort or infotainment functions.

Information on data that has been stored or exchanged can be obtained from the manufacturer of the vehicle, for example via a separate booklet.

### Personal reference

Each vehicle is identified with a clear vehicle identification number. Depending on the country, the vehicle identification num-

ber, the number plate and the corresponding authorities can be referenced to ascertain the vehicle owner. There are also other ways to use data obtained from the vehicle to trace the rider or vehicle owner, for example using the ConnectedDrive user account.

### **Data protection rights**

In accordance with applicable data protection laws, vehicle users have certain rights in relation to the manufacturer of the vehicle or in relation to companies which collect or process personal data.

Vehicle users have the right to obtain full information at no cost from persons or entities storing personal data of the vehicle user. These entities may include:

- Manufacturer of the vehicle
- Qualified service partners
- Specialist workshops
- Service providers

Vehicle users have the right to request information on what personal data has been stored, for what purpose the data is used, and where the data comes from. To obtain this information, proof of ownership or use is required. The right to information also includes information about data that has been shared with other companies or entities. The website of the vehicle manufacturer contains the applicable data protection information. This data protection information includes information on the right to have data deleted or corrected. The manufacturer of the vehicle also provides their contact details and those of the data protection officer on their website.

The vehicle owner can also request that a BMW Motorrad Retailer or another qualified service partner or specialist workshop read out the data that is stored in the vehicle for a charge.

The vehicle data is read out using the legally prescribed socket for on-board diagnosis (OBD) in the vehicle.

### **Legal requirements for the disclosure of data**

As part of its legal responsibilities, the manufacturer of the vehicle is obligated to make its stored data available to the relevant authorities. This data is provided in the required scope in individual cases, for example to clarify a criminal offence. In the context of applicable laws, public agencies are entitled in individual cases to read out data from the vehicle themselves.

## Operating data in the vehicle

Control units process data to operate the vehicle.

This includes, for example:

- Status reports of the vehicle and its individual components, for example wheel revolutions, wheel speed, deceleration
- Environmental conditions, for example temperature

The data is only processed in the vehicle itself and is generally non-permanent. The data is not stored beyond the operating period.

Electronic components, for example control units, contain components for storing technical information. Information can be temporarily or permanently stored on the vehicle condition, component loads, incidents or errors. This information is generally used to document the condition of a component, a module, a system

or the surrounding area, for example:

- Operating conditions of system components, for example filling levels, tyre pressure
- Malfunctions and faults in important system components, for example light and brakes
- Response of the vehicle in special riding situations, for example engagement of the driving dynamics systems
- Information on incidents resulting in damage to the vehicle

The data is necessary for the provision of control unit functions. Furthermore, the data is used to detect and rectify malfunctions and to enable the vehicle manufacturer to optimise vehicle functions.

The vast majority of this data is non-permanent and is only processed in the vehicle itself. Only a small amount of the data is

stored in incident or fault memories as required by events.

If services are accessed, for example repairs, service processes, warranty cases and quality assurance measures, this technical information can be read out of the vehicle together with the vehicle identification number.

The information can be read out by a BMW Motorrad Retailer or another qualified service partner or specialist workshop. The legally stipulated socket for on-board diagnosis (OBD) in the vehicle is used to read out the data.

The data is obtained, processed and used by the relevant parts of the retailer network. The data is used to document the technical conditions of the vehicle, to help with error localization, to comply with warranty obligations and to improve quality.

In addition, the manufacturer has various product monitoring obligations arising from product liability legislation. To meet these obligations, the vehicle manufacturer requires technical data from the vehicle. The data from the vehicle can also be used to check warranty claims from the customer.

Error and incident memories in the vehicle can be reset during servicing or repair work by a BMW Motorrad Retailer or another qualified service partner or specialist workshop.

## **Data input and data transfer in the vehicle**

### **General**

Depending on the equipment, comfort and customised settings can be stored in the vehicle and can be changed or reset at any time.

This includes, for example:

- Settings of the windscreen position
- Chassis and suspension settings

If required, data can be entered in the entertainment and communication system of the vehicle, for example using a smartphone.

Depending on the individual equipment, this includes:

- Multimedia data, such as music for playback
- Contacts data for use in connection with a communication system or an integrated navigation system
- Entered destinations
- Data on the use of internet services. This data can be stored locally in the vehicle or is located on a device that is connected to the vehicle, for example smartphone, USB stick, MP3 player. If this data is

stored in the vehicle, the data can be deleted at any time.

This data is transferred to third parties only if personally requested within the context of using online services. This depends on the selected settings when using the services.

### **Incorporation of mobile end devices**

Depending on the equipment, mobile end devices connected to the vehicle, for example smartphones, can be controlled using the operating elements of the vehicle.

The image and sound of the mobile end device can then be output via the multimedia system. At the same time, specific information is transferred to the mobile end device. Depending on the type of integration, this includes, for example, position data and additional general vehicle information. This enables optimal

use of the selected apps, for example navigation or music playback.

The type of additional data processing is determined by the provider of the respective app. The scope of the possible settings depends on the corresponding app and the operating system of the mobile end device.

## Services

### General

If the vehicle has a wireless connection, this enables the exchange of data between the vehicle and other systems. The wireless connection is enabled by the vehicle's own transmitter and receiver unit or using personally integrated mobile end devices, for example smartphones. Online functions can be used using this wireless connection. These include online services and apps that are provided by the vehicle

manufacturer or by other providers.

### Services of the vehicle manufacturer

For online services of the vehicle manufacturer, the individual functions are described at suitable points, for example rider's manual, website of the manufacturer. At the same time, information is also provided on the relevant data protection law. Personal data may be used to provide online services. Data is exchanged using a secure connection, for example with the IT systems provided by the vehicle manufacturer.

Obtaining, processing and using personal data outside of the normal provision of services requires legal permission, contractual agreement or consent. It is also possible to have the entire data connection activated or de-

activated. Statutory functions are excluded from this.

### Services from other providers

When using online services from other providers, these services are subject to the responsibility and the data protection and operating conditions of the individual provider. The vehicle manufacturer has no influence on the content that is exchanged in this instance. Information on the type, scope and purpose of the data capture and use of personal data as part of the services of third parties can be ascertained from the individual provider.

## Intelligent emergency call system

- with intelligent emergency call<sup>OE</sup>

## Principle

The intelligent emergency call system enables manual or automatic emergency calls, for example in the event of an accident.

The emergency calls are received by an emergency call centre that is commissioned by the vehicle manufacturer.

For information on operating the intelligent emergency call system and its functions, please refer to "Intelligent emergency call".

## Legal basis

Processing of personal data using the intelligent emergency call system is in line with the following regulations:

- Protection of personal data: Directive 95/46/EC of the European Parliament and of the Council.

- Protection of personal data: Directive 2002/58/EC of the European Parliament and of the Council.

The legal basis for the activation and function of the intelligent emergency call system is the concluded ConnectedRide contract for this function, as well as the corresponding laws, ordinances and directives of the European Parliament and of the European Council.

The relevant ordinances and directives regulate the protection of natural persons during the processing of personal data.

The processing of personal data by the intelligent emergency call system satisfies the European directives for the protection of personal data.

The intelligent emergency call system processes personal data

only with the agreement of the vehicle owner.

The intelligent emergency call system and other services with additional benefits may only process personal data with the express permission of the person affected by the data processing, for example the vehicle owner.

## SIM card

The intelligent emergency call system is operated by mobile radio using the SIM card installed in the vehicle. The SIM card is permanently logged into the mobile phone network to enable rapid connection setup. Data is sent to the vehicle manufacturer in the event of an emergency.

## Improving quality

The data that is transferred in an emergency is also used by the manufacturer of the vehicle

to improve product and service quality.

### **Location determination**

The position of the vehicle can be determined exclusively by the mobile phone network provider based on the mobile phone site locations. The provider cannot link the vehicle identification number and phone number of the installed SIM card. Only the manufacturer of the vehicle can link the vehicle identification number and phone number of the installed SIM cards.

### **Log data of emergency calls**

The log data of emergency calls is stored in a memory of the vehicle. The oldest log data is regularly deleted. The log data includes, for example, information on when and where an emergency call was made. In exceptional cases, the log data can be

read out of the vehicle memory. As a rule, log data is only read out following a court order, and this is only possible if the corresponding devices are connected directly to the vehicle.

### **Automatic emergency call**

The system is designed so that, following a sufficiently serious accident, which is detected by sensors in the vehicle, an emergency call is automatically activated.

### **Sent information**

When making an emergency call using the intelligent emergency call system, the system forwards the same information to the designated emergency call centre as is forwarded to the public emergency operations centre by the statutory emergency call system eCall.

In addition, the intelligent emergency call system sends the following additional information to an emergency call centre commissioned by the vehicle manufacturer and, if required, to the emergency services:

- Accident data, for example the direction of impact detected by the vehicle sensors, to assist the emergency services response.
- Contact details, for example the phone number of the installed SIM card and the phone number of the rider, if available, to enable rapid contact with those involved in the accident if required.

### **Data storage**

The data for an activated emergency call is stored in the vehicle. The data contains information on the emergency



call, for example the location and time of the emergency call.

The voice recordings of the emergency call are stored at the emergency call centre.

The voice recordings of the customer are stored for 24 hours in case details of the emergency call need to be analysed. After this, the voice recordings are deleted. The voice recordings of the employee of the emergency call centre are stored for 24 hours for quality assurance purposes.

### **Information on personal data**

The data that is processed as part of the intelligent emergency call is processed exclusively to carry out the emergency call. As part of its statutory obligation, the manufacturer of the vehicle provides information about the data that it has processed and any data that it still has stored.



## General views

General view, left side .....	19
General view, right side .....	21
Underneath the seat .....	22
Multifunction switch, left .....	23
Multifunction switch, right.....	25
Instrument panel .....	26



## General view, left side

- 1 Fuel filler neck (→ 149)
- 2 Seat lock (→ 96)
- 3 Setting the rear damping  
(down at the spring strut)  
(→ 133)

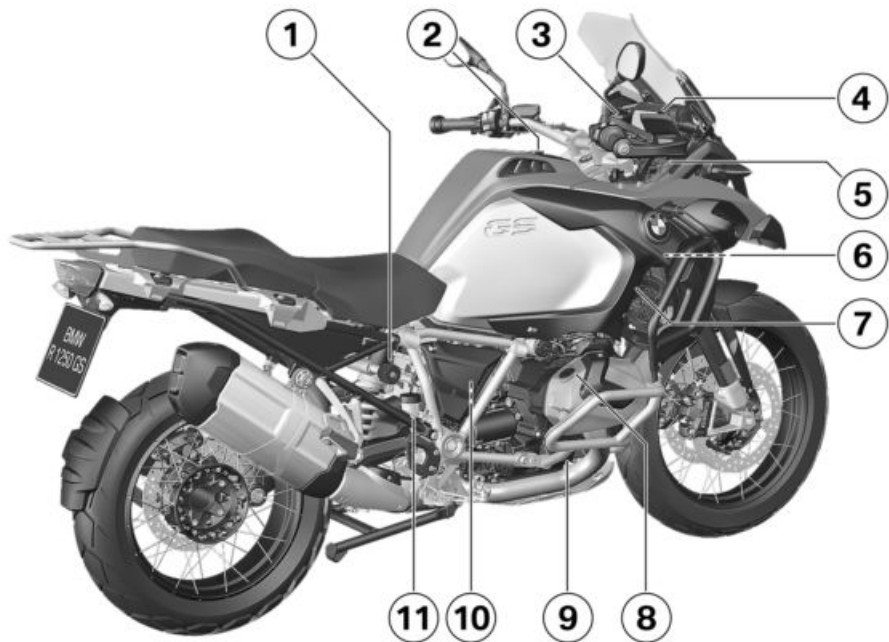

## General view, right side

- 1** Adjuster for spring preload, rear (▣▣▣▣ 132)
- 2** Air filter (under the centre trim panel) (▣▣▣▣ 189)
- 3** Brake-fluid reservoir, front (▣▣▣▣ 178)
- 4** Height adjustment of the windscreen (▣▣▣▣ 126)
- 5** Power socket (▣▣▣▣ 204)
- 6** Vehicle identification number (on the steering-head bearing)  
Type plate (on the steering-head bearing)
- 7** Coolant-level indicator (▣▣▣▣ 180)  
Coolant reservoir (▣▣▣▣ 181)
- 8** Oil filler opening (▣▣▣▣ 175)
- 9** Engine oil level indicator (▣▣▣▣ 174)
- 10** Behind the side trim panel:  
Battery (▣▣▣▣ 194)  
Remote positive terminal (▣▣▣▣ 193)  
Diagnostic connector (▣▣▣▣ 200)
- 11** Brake-fluid reservoir, rear (▣▣▣▣ 179)

## Underneath the seat

- 1 Standard toolkit (► 172)
- 2 Rider's manual
- 3 Table of tyre pressures
- 4 Payload table
- 5 Adjuster for front-seat height (► 97)
- 6 Fuses (► 198)

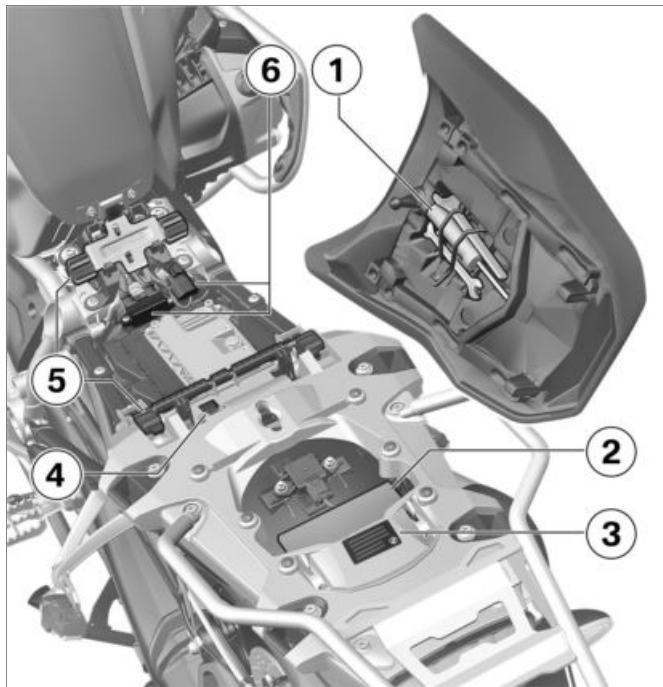



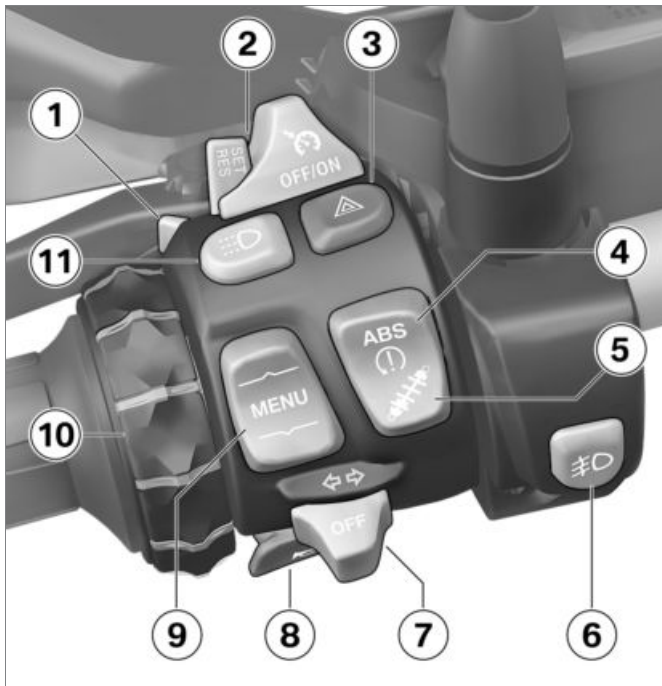

## Multifunction switch, left

- 1 High-beam headlight and headlight flasher (➔ 71)
- 2 – with cruise control<sup>OE</sup>  
Cruise-control system (➔ 87).
- 3 Hazard warning lights system (➔ 74)
- 4 ABS (➔ 76)  
ASC/DTC  
Switch off the ASC/DTC function (➔ 78).
- 5 – with Dynamic ESA<sup>OE</sup>  
Dynamic ESA possible settings (➔ 79)
- 6 – with LED additional headlight<sup>OA</sup>  
Auxiliary headlights (➔ 72).
- 7 Turn indicators (➔ 75)
- 8 Horn
- 9 MENU rocker switch (➔ 103)

- 10 Multi-Controller Controls (►►► 103)
- 11 – with daytime riding light<sup>OE</sup>  
Manual daytime riding light (►►► 73).

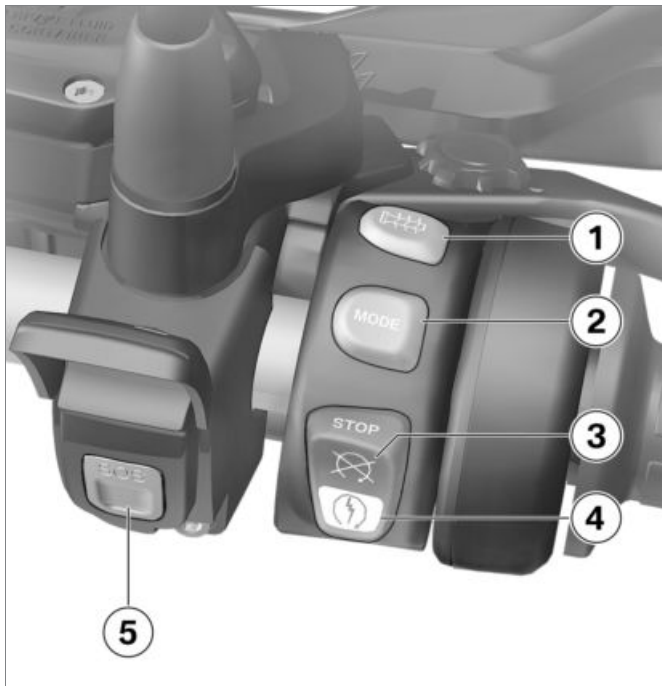

## Multifunction switch, right

- 1 – with heated grips<sup>OE</sup>  
Heated handlebar grips (➔ 95).
- 2 Riding mode (➔ 82)
- 3 Emergency off switch (kill switch) (➔ 68)
- 4 Starter button  
Starting the engine (➔ 139).
- 5 SOS button  
Intelligent emergency call (➔ 69)

## Instrument panel

- 1 Indicator and warning lights (➡ 28)
- 2 TFT display (➡ 30)  
(➡ 32)
- 3 Alarm system LED  
– with anti-theft alarm (DWA)<sup>OE</sup>  
Alarm signal (➡ 93)  
– with Keyless Ride<sup>OE</sup>  
Indicator light for the radio-operated key  
Switching on ignition (➡ 65).
- 4 Photosensor (for adapting the brightness of the instrument lighting)





## Status indicators

Indicator and warning lights .....	28
TFT display in Pure Ride view .....	30
TFT display in view menu .....	32
Warnings .....	33

## Indicator and warning lights

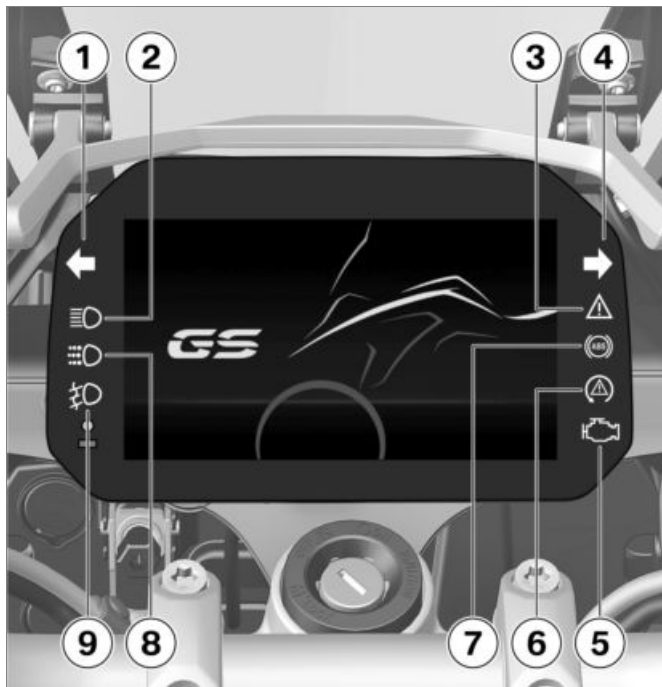
- 1 Turn indicators, left  
Operating the turn indicators (►► 75).
- 2 High-beam (►► 71)
- 3 General warning light (►► 33)
- 4 Turn indicators, right  
with export to EU markets<sup>NV</sup>
- 5 Malfunction indicator lamp  
Emissions warning (►► 48)
- 6 ASC (►► 55)  
– with riding modes Pro<sup>OE</sup>  
DTC (►► 55)
- 7 ABS (►► 76)
- 8 – with daytime riding  
light<sup>OE</sup>  
Manual daytime riding light (►► 73).



- 9** – with LED additional  
headlight<sup>OA</sup>  
Auxiliary headlights  
( 72).

## TFT display in Pure Ride view

- 1 Hill Start Control (➡ 58)
- 2 Changing the operating focus (➡ 107)
- 3 Engine speed display (➡ 109)
- 4 Driver info. status line (➡ 108)
- 5 Speedometer
- 6 Coding plug (➡ 86)
- 7 Riding mode (➡ 82)
- 8 Recommendation to up-shift (➡ 110)
- 9 Gear indicator; "N" indicates neutral.
- 10 Speed Limit Info (➡ 109)
- 11 – with cruise control<sup>OE</sup>  
Cruise-control system (➡ 87).
- 12 Clock (➡ 111)
- 13 Connection status (➡ 113)
- 14 Muting (➡ 111)

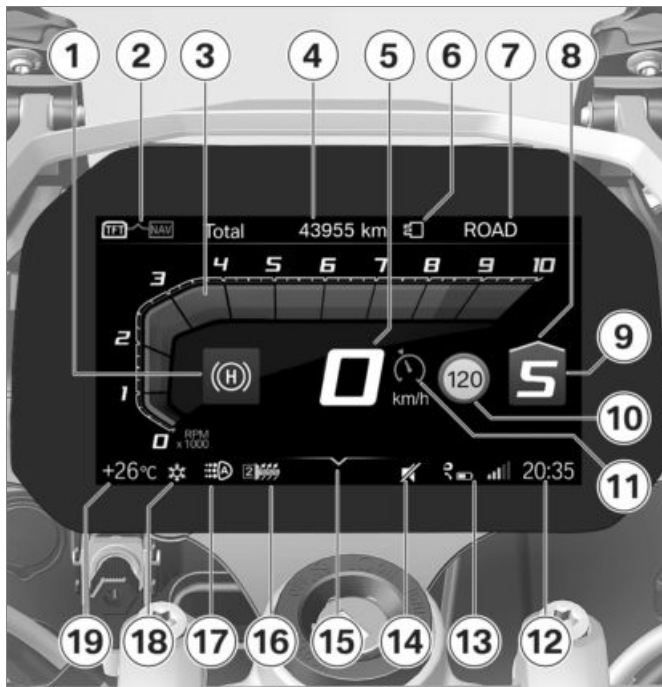



- 15** Operator help
- 16** Heating stages, handlebar grips (➡ 95)
- 17** Automatic daytime riding light (➡ 73)
- 18** Outside temperature warning (➡ 43)
- 19** Ambient temperature

## TFT display in view menu

- 1 Hill Start Control (➡ 58)
- 2 Speedometer
- 3 – with cruise control<sup>OE</sup>  
Cruise-control system (➡ 87).
- 4 Speed Limit Info (➡ 109)
- 5 Coding plug (➡ 86)
- 6 Riding mode (➡ 82)
- 7 Driver info. status line (➡ 108)
- 8 Recommendation to up-shift (➡ 110)
- 9 Gear indicator; "N" indicates neutral.
- 10 Clock
- 11 Connection status
- 12 Muting (➡ 111)
- 13 Operator help
- 14 Heating stages, handlebar grips (➡ 95)
- 15 Automatic daytime riding light (➡ 73)

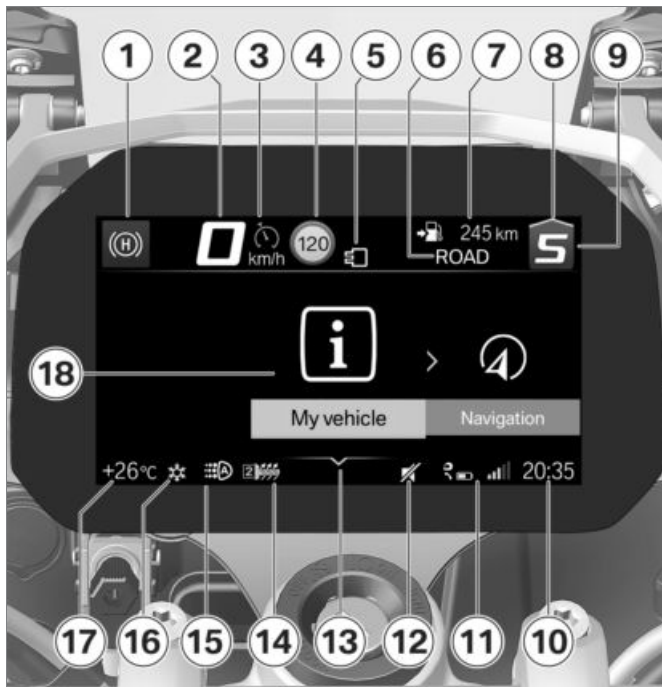

- 16 Outside temperature warning (☰➔ 43)
- 17 Ambient temperature
- 18 Menu section

## Warnings

### Mode of presentation

Warnings are indicated by the corresponding warning lights. Warnings are shown by the general warning light in connection with a dialogue in the TFT display. The 'general' warning light is yellow or red, depending on the urgency of the warning.



The general warning light is displayed according to the most urgent warning . The possible warnings are listed on the following pages.



### Check Control display

The messages shown in the display vary. Different colours and symbols are used depending on priority:

- Green CHECK OK **1**: no message, optimum values.
- White circle with small "i" **2**: information.
- Yellow warning triangle **3**: warning message, value not optimum.
- Red warning triangle **3**: warning message, value critical

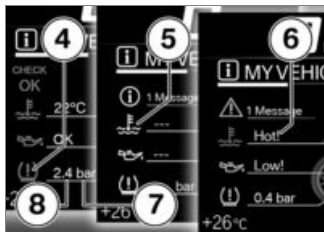

### Values display

The symbols **4** displayed vary. Different colours are used depending on assessment. Instead of numerical values **8** with units **7**, texts **6** are displayed:

### Colour of the symbol

- Green: (OK) current value is optimum.
- Blue: (Cold!) Current temperature is too low.
- Yellow: (Low! / High!) Current value is too low or too high.
- Red: (Hot! / High!) Current temperature or value is too high.

- White: (---) Valid value not available. Instead of the value, dashes **5** are displayed.



### NOTICE

The assessment of some values is only possible from a certain journey duration or speed. If a measured value is still not being displayed because the conditions for measurement have not been met, dashes are displayed instead as a placeholder. If there are no valid measured values, there will be no assessment in the form of a coloured symbol. ◀



### Check Control dialogue

Messages are output as a Check Control dialogue **1**.

- If several CC messages with the same priority are present, the messages alternate in the order they occurred until these are acknowledged.
- If the symbol **2** is actively being displayed, it can be acknowledged by holding the Multi-Controller to the left.
- Check Control messages are dynamically attached as additional tabs on the pages in the menu My vehicle (105). You can go to the message













again as long as the fault persists.













## Warnings, overview

### Indicator and warning lights

### Display text

### Meaning













		Ice crystal symbol is displayed.	Outside temperature warning (▶▶▶▶ 43)
		General warning light shows yellow.	
		Remote key not in range.	Radio-operated key out of range (▶▶▶▶ 43)
		General warning light shows yellow.	
		Remote key battery at 50%.	Replacing battery of remote key (▶▶▶▶ 44)
		Remote key battery weak.	
		General warning light shows yellow.	
		is displayed in yellow.	Vehicle voltage too low (▶▶▶▶ 44)
		Vehicle voltage low.	
		General warning light shows red.	
		is displayed in red.	Vehicle voltage critical (▶▶▶▶ 44)
		Vehicle voltage critical!	

Indicator and warning lights	Display text	Meaning
 General warning light shows yellow.	 The faulty light source is displayed.	Bulb faulty (→ 45)
	 Alarm system battery weak.	Anti-theft alarm battery weak (→ 46)
 General warning light shows yellow.	 Alarm system battery empty.	Anti-theft alarm battery flat (→ 46)
	 Engine oil level Check engine oil level.	Electronic oil-level check: check the engine oil level. (→ 47)
 General warning light shows red.	 Coolant temperature too high!	Coolant temperature too high (→ 47)
 The malfunction indicator lamp lights up.	 Engine!	Emissions warning (→ 48)
 General warning light shows yellow.	 No communication with engine control.	Engine control failed (→ 48)











## Indicator and warning lights

## Display text

## Meaning

	General warning light shows yellow.	 Fault in the engine control.	Engine in emergency-operation mode (►► 48)
	General warning light flashes yellow.	 Serious fault in the engine control!	Severe fault in the engine control (►► 49)
	General warning light shows yellow.	 is displayed in yellow.	Tyre pressure in limit range of the permitted tolerance (►► 50)
		 Tyre pressure is not at set-point.	
	General warning light flashes red.	 is displayed in red.	Tyre pressure outside the permitted tolerance (►► 51)
		 Tyre pressure is not at set-point.	
		 Tyre press. control. Loss of pressure.	
		 "----"	Transmission fault (►► 52)













Indicator and warning lights	Display text	Meaning
 General warning light shows yellow.	 "----"	Sensor faulty or system fault (→ 53)
 General warning light shows yellow.	 RDC sensor battery weak.	Battery for tyre pressure sensor weak (→ 53)
	 Drop sensor faulty.	Drop sensor defective (→ 53)
	 Intell. emerg. call failure.	Emergency call function restricted (→ 53)
	 Side stand monitoring faulty.	Side stand monitoring is faulty (→ 54)
 ABS telltale and warning light flashes.		ABS self-diagnosis not completed (→ 54)
 ABS indicator and warning light shows.	 Off!	ABS deactivated (→ 54)
	 ABS deactivated.	

## Indicator and warning lights

## Display text











## Meaning

	ABS indicator and warning light shows.	 Limited ABS availability!	ABS fault (→ 54)
	ABS indicator and warning light shows.	 ABS failure!	ABS failed (→ 55)
	ABS indicator and warning light shows.	 ABS Pro failure!	ABS Pro failed (→ 55)
	ASC/DTC indicator and warning light flashes quickly.		ASC/DTC intervention (→ 55)
	ASC/DTC indicator and warning light flashes slowly.		ASC/DTC self-diagnosis not completed (→ 56)
	ASC/DTC indicator and warning light comes on.	 Off!	ASC/DTC switched off (→ 56)
		 Traction control deactivated.	

## Indicator and warning lights

## Display text







## Meaning

 ASC/DTC indicator and warning light comes on.	 Traction control limited!	ASC/DTC restricted (→ 56)
 ASC/DTC indicator and warning light comes on.	 Traction control failure!	ASC/DTC fault (→ 57)
 General warning light shows yellow.	 Spring strut adjustment faulty!	D-ESA fault (→ 57)
	 Fuel reserve reached. Go to a filling station soon	Fuel down to reserve (→ 57)
	 Green holding symbol is displayed.	Hill Start Control active (→ 58)
	 Yellow holding symbol flashes.	Hill Start Control automatically deactivated (→ 58)
	 Crossed-out holding symbol is displayed.	Hill Start Control cannot be activated (→ 58)

## Indicator and warning lights

### Display text

### Meaning

	 The gear indicator flashes.	Gear not trained (→ 58)
 Turn signal indicator light flashes green.		Hazard warning lights system is switched on (→ 59)
 Turn signal indicator light flashes green.		
	 is displayed in white.	Service due (→ 59)
	Service due!	
 General warning light shows yellow.	 is displayed in yellow.	Service-due date has passed (→ 60)
	Service over-due!	

## Ambient temperature

The outside temperature is displayed in the status line of the TFT display.

When the motorcycle is at a standstill, the heat of the engine can falsify the ambient-temperature reading. If the heat of the engine is affecting it too much, dashes are temporarily shown in place of the value.



There is a risk of black ice if the outside temperature falls below the following limit value.



Limit value for the ambient temperature

approx. 3 °C

Once the temperature has fallen below that value, the outside temperature display along with a ice crystal symbol flashes in the status line on the TFT display.

## Outside temperature warning



Ice crystal symbol is displayed.

Possible cause:



The air temperature measured at the vehicle is lower than:

approx. 3 °C



**WARNING**

### Risk of black ice also applicable at over 3 °C

Risk of accident

- Always take extra care when temperatures are low; remember that there is particular danger of black ice forming on bridges and where the road is in shade.◀
- Ride carefully and think well ahead.

## Radio-operated key out of range

– with Keyless Ride<sup>OE</sup>



General warning light shows yellow.



Remote key not in range. Not possible to switch on ignition again.

Possible cause:

Communication between R/C key and engine electronics is disrupted.

- Check the battery in the radio-operated key.  
– with Keyless Ride<sup>OE</sup>
- Replace the battery of the radio-operated key (▶▶▶ 67).
- Use the reserve key to continue your journey.  
– with Keyless Ride<sup>OE</sup>
- Battery of the radio-operated key is empty or loss of the radio-operated key (▶▶▶ 66).

- If a check control dialogue box appears during the journey, remain calm. You can continue your journey; the engine will not switch off.
- Have the defective radio-operated key replaced by an authorised BMW Motorrad dealer.

### Replacing battery of remote key

 General warning light shows yellow.

 Remote key battery at 50%. No functional impairment.

 Remote key battery weak. Limited central locking function. Change battery.

Possible cause:

- The battery of the remote key has lost a significant proportion of its original capacity. The function of the remote key is

only still ensured for a limited time.

- with Keyless Ride<sup>OE</sup>
- Replace the battery of the radio-operated key (▮▮▮▮ 67).

### Vehicle voltage too low

 General warning light shows yellow.

 is displayed in yellow.

 Vehicle voltage low. Switch off unnecessary consumers.

### WARNING

#### Failure of the vehicle systems

Risk of accident

- Do not continue your journey.◀

The battery will not be charged. By continuing to drive on, the vehicle electronics discharge the battery.



### NOTICE

The fuse for the alternator regulator can blow if the 12 V battery is installed incorrectly or if the terminals are swapped (e.g. when using a starting aid).◀

Possible cause:

Alternator or alternator drive faulty or fuse for alternator regulator has blown.

- Have the fault rectified as quickly as possible by a specialist workshop, preferably an authorised BMW Motorrad dealer.

### Vehicle voltage critical

 General warning light shows red.

 is displayed in red.

 Vehicle voltage critical! Consumers have been switched off. Check battery condition.

## WARNING

### Failure of the vehicle systems

Risk of accident

- Do not continue your journey.◀

The battery will not be charged. By continuing to drive on, the vehicle electronics discharge the battery.

## NOTICE

The fuse for the alternator regulator can blow if the 12 V battery is installed incorrectly or if the terminals are swapped (e.g. when using a starting aid).◀

Possible cause:  
Alternator or alternator drive faulty or fuse for alternator regulator has blown.

- Have the fault rectified as quickly as possible by a specialist workshop, preferably an authorised BMW Motorrad dealer.

### Bulb faulty

 General warning light shows yellow.

 The faulty light source is displayed:

 High beam faulty!

 Front left turn indicator faulty! OR Front right turn indicator faulty!

 Low-beam headlight faulty!

 Front side light faulty!

– with daytime riding light<sup>OE</sup>

 Daytime riding light faulty!◀

– with LED additional headlight<sup>OA</sup>

 Left additional headlight faulty!  
OR Right additional headlight faulty!◀

 Tail light faulty!

 Brake light faulty!

 Rear left turn indicator faulty! OR Rear right turn indicator faulty!

 Number plate light faulty!

– Have it checked by a specialist workshop.

**WARNING****Vehicle overlooked in traffic due to failure of the lights on the vehicle**

Safety risk

- Replace defective bulbs as soon as possible; always carry a complete set of spare bulbs if possible. ◀

Possible cause:

One or more light sources are faulty.

- Identify the faulty light source through a visual inspection.
  - Replacing the LED headlight (▮▮▮▮▶ 193).
  - Replacing bulbs for front and rear turn indicators (▮▮▮▮▶ 191).
  - Replacing LED rear light (▮▮▮▮▶ 193).
- with LED flashing turn indicator<sup>OE</sup>
- Replace LED flashing turn indicators (▮▮▮▶ 192).

**Anti-theft alarm battery weak**

– with anti-theft alarm (DWA)<sup>OE</sup>



Alarm system battery weak. No restrictions. Make an appointment at a specialist workshop.

**NOTICE**

This error message shows briefly only after the Pre-Ride-Check completes. ◀

Possible cause:

The integral battery in the anti-theft alarm has lost a significant proportion of its original capacity. There is no assurance of how long the anti-theft alarm can remain operational if the vehicle's battery is disconnected.

- Seek the advice of a specialist workshop, preferably an authorised BMW Motorrad dealer.

**Anti-theft alarm battery flat**

– with anti-theft alarm (DWA)<sup>OE</sup>



General warning light shows yellow.



Alarm system battery empty. No independent alarm. Make an appointment at a specialist workshop.

**NOTICE**

This error message shows briefly only after the Pre-Ride-Check completes. ◀

Possible cause:

The integral battery in the anti-theft alarm has lost its entire original capacity. There is no assurance that the anti-theft alarm will be operational if the vehicle's battery is disconnected.



- Seek the advice of a specialist workshop, preferably an authorised BMW Motorrad dealer.

## Electronic oil-level check

 The electronic oil-level check assesses the oil level in the engine with OK or Low!

The following preconditions have to be satisfied for electronic oil-level checking, and several measurements might have to be taken:

- Rider is sitting on the vehicle and vehicle has just been ridden at a speed of at least 10 km/h.
- Engine idling for at least 20 seconds.
- Engine is at operating temperature.
- Side stand is retracted and vehicle is not propped on its centre stand.

- No brake applied and Hill Start Control (HSC) is not active.
- Vehicle is standing upright on a smooth, level surface.
- The spring strut is appropriately set for the load status, or D-ESA is in the Auto load setting.

If measurement is incomplete or if these conditions are not met, the oil level cannot be judged by the system. Dashes (---) appear on the display instead of a reading.

## Electronic oil-level check: check the engine oil level

 Engine oil level Check engine oil level.

Possible cause:

The electronic oil-level sensor has registered a low oil level. If the vehicle is not standing upright on a smooth, level surface, the message might appear even

though the oil level is correct. The next time you stop for fuel:

- Checking engine oil level (▬▬▬ 174).

If the oil level in the sight glass is too low:

- Topping up the engine oil (▬▬▬ 175).

When the oil level in the sight glass is correct:

- Check whether the preconditions for the electronic oil-level check are met.

If the message appears repeatedly, even though the oil level is slightly below the maximum mark:

- Seek the advice of a specialist workshop, preferably an authorised BMW Motorrad dealer.

## Coolant temperature too high

 General warning light shows red.



Coolant temperature too high! Check coolant level. Continue under part. load to cool down.



## ATTENTION

### Riding with overheated engine

Engine damage

- Compliance with the information set out below is essential. ◀

Possible cause:

The coolant level is too low.

- Check coolant level (→ 180).
- If the coolant level is too low:
- Top up the coolant and have the coolant system checked by a specialist workshop, preferably by an authorised BMW Motorrad dealer.

Possible cause:

The coolant temperature is too high.

- If possible, ride in the part-load range to cool down the engine.
- If the coolant temperature is frequently too high, have the fault rectified as soon as possible by a specialist workshop, preferably an authorised BMW Motorrad dealer.

### Emissions warning



The malfunction indicator lamp lights up.



Engine! Have it checked by a specialist workshop.

Possible cause:

The engine control unit has diagnosed a fault which affects the pollutant emissions.

- Have the fault rectified by a specialist workshop, preferably

an authorised BMW Motorrad dealer.

- » You can continue riding; pollutant emissions are higher than the threshold values.

### Engine control failed



General warning light shows yellow.



No communication with engine control. Multiple sys. affected. Ride carefully to the next specialist workshop.

### Engine in emergency-operation mode



General warning light shows yellow.



Fault in the engine control. Riding at mod. speed pos. Ride carefully to next specialist workshop.

## **WARNING**

### **Unusual ride characteristics when engine running in emergency-operation mode**

Risk of accident

- Avoid accelerating sharply and overtaking.◀

Possible cause:

The engine control unit has diagnosed a fault which impairs the engine performance or throttle response. The engine is in emergency-operation mode. In exceptional cases, the engine stops and refuses to start.

- Have the fault rectified as quickly as possible by a specialist workshop, preferably an authorised BMW Motorrad dealer.
- » It is possible to continue riding, however the engine performance and engine speed range

may be impaired and not function as normal.

### **Severe fault in the engine control**



General warning light flashes yellow.



Serious fault in the engine control!  
Riding at mod. speed pos.  
Damage possible. Have checked by workshop.

## **WARNING**

### **Engine damage when running in emergency-operation mode**

Risk of accident

- Ride slowly, avoid accelerating sharply and overtaking.
- If possible, have the vehicle picked up and have the fault rectified by a specialist workshop, preferably an authorised BMW Motorrad Retailer.◀

Possible cause:

The engine control unit has diagnosed a fault which may cause severe secondary faults. The engine is in emergency-operation mode.

- It is possible to continue to ride but not recommended.
- Avoid high load and rpm ranges if possible.
- Have the fault rectified as quickly as possible by a specialist workshop, preferably an authorised BMW Motorrad dealer.

### **Tyre pressure**

– with tyre pressure control (RDC)<sup>OE</sup>

In addition to the MY VEHICLE menu screen and the Check Control messages, there is also the TYRE PRESSURE screen for the display of the tyre inflation pressures:

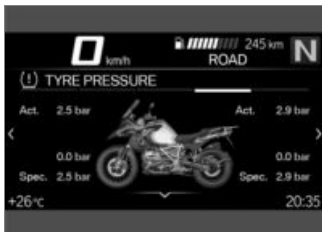

The left values refer to the front wheel, the right values to the rear wheel.

The pressure difference is displayed via the actual and target tyre pressure.

Only dashes are displayed immediately after the ignition is switched on. The transmission of the tyre pressure values begins only after the first time the following minimum speed has been exceeded:



RDC sensor is not active

min 30 km/h (The RDC sensor does not transmit its signal to the vehicle until a certain minimum speed has been reached.)



The tyre pressures are shown in the TFT display as temperature compensated and always refer to the following tyre air temperature:

20 °C



If the tyre symbol is additionally displayed in yellow or red, this is a warning. The pressure difference is highlighted with an exclamation point in the same colour.



If the value in question is close to the limit of the permissible tolerance range, the 'General' warning light also lights up in yellow.



If the tyre pressure registered by the sensor is outside the permissible tolerance range, the 'General' warning light flashes red.

For further information about the BMW Motorrad RDC, see the section entitled "Engineering details" from page (➔ 165) onwards.

### Tyre pressure in limit range of the permitted tolerance

– with tyre pressure control (RDC)<sup>OE</sup>

 General warning light shows yellow.

 is displayed in yellow.

 Tyre pressure is not at setpoint. Check tyre pressure.

Possible cause:

Measured tyre pressure is close to the limit of permitted tolerance.

- Correct tyre pressure.
- Before adjusting the tyre pressure, observe the information on temperature compensation and pressure adaptation in the section entitled "Engineering details":

- » Temperature compensation (▮▮▮ 166)
- » Pressure adaptation (▮▮▮ 166)
- » Find the correct tyre pressures in the following places:

- On the back cover of the rider's manual
- Instrument cluster in the TYRE PRESSURE view
- Sign under the seat

### **Tyre pressure outside the permitted tolerance**

- with tyre pressure control (RDC)<sup>OE</sup>

 General warning light flashes red.

 is displayed in red.

 Tyre pressure is not at setpoint. Stop immediately! Check tyre pressure.

 Tyre press. control. Loss of pressure. Stop immediately! Check tyre pressure.

## **WARNING**

### **Tyre pressure outside the permitted tolerance.**

Risk of accident, degradation of the vehicle's driving characteristics.

- Adapt your style of riding accordingly. ◀

Possible cause:

Measured tyre pressure is outside permitted tolerance.

- Check the tyre for damage and to ascertain whether the vehicle can be ridden with the tyre in its present condition. If the vehicle can be ridden with the tyre in its present condition:
- Correct the tyre pressure at the earliest possible opportunity.
- Before adjusting the tyre pressure, observe the information on temperature compensation and pressure adaptation in the

section entitled "Engineering details":

- » Temperature compensation (▣▣▣ 166)
- » Pressure adaptation (▣▣▣ 166)
- » Find the correct tyre pressures in the following places:
  - On the back cover of the rider's manual
  - Instrument cluster in the **TYRE PRESSURE** view
  - Sign under the seat
- Have the tyre checked for damage by a specialist workshop, preferably an authorised BMW Motorrad Retailer.



## NOTICE

You can deactivate RDC warnings for riding in off-road mode. ◀

If you are unsure whether the vehicle can be ridden with the tyre in its present condition:

- Do not continue your journey.

- Notify the breakdown service.

## Transmission fault

- with tyre pressure control (RDC)<sup>OE</sup>



"----"

Possible cause:

The vehicle did not reach the minimum required speed (▣▣▣ 165).



RDC sensor is not active

min 30 km/h (The RDC sensor does not transmit its signal to the vehicle until a certain minimum speed has been reached.)

- Increase speed above this threshold and observe the RDC readings. Assume that a permanent fault has not occurred unless the 'General' warning

light comes on to accompany the symptoms. Under these circumstances:

- Have the fault rectified by a specialist workshop, preferably an authorised BMW Motorrad dealer.

Possible cause:

Wireless communication with the RDC sensors has been disrupted. Possible causes include radio-communication systems operating in the vicinity and interfering with the link between the RDC control unit and the sensors.

- Move to another location and observe the RDC readings. Assume that a permanent fault has not occurred unless the 'General' warning light comes on to accompany the symptoms. Under these circumstances:
- Have the fault rectified by a specialist workshop, preferably

an authorised BMW Motorrad dealer.

## Sensor faulty or system fault

– with tyre pressure control (RDC)<sup>OE</sup>

 General warning light shows yellow.

 "----"

Possible cause:

Vehicle is fitted with wheels not equipped with RDC sensors.

- Fit wheels and tyres equipped with RDC sensors.

Possible cause:

1 or 2 RDC sensors have failed or a system error has occurred.

- Have the fault rectified by a specialist workshop, preferably an authorised BMW Motorrad dealer.

## Battery for tyre pressure sensor weak

– with tyre pressure control (RDC)<sup>OE</sup>

 General warning light shows yellow.

 RDC sensor battery weak. Function limited. Have it checked by a specialist workshop.

### NOTICE

This error message shows briefly only after the Pre-Ride-Check completes. ◀

Possible cause:

The integral battery in the tyre-pressure sensor has lost a significant proportion of its original capacity. There is no assurance of how long the tyre pressure control system can remain operational.

- Seek the advice of a specialist workshop, preferably an authorised BMW Motorrad dealer.

## Drop sensor defective

 Drop sensor faulty. Have it checked by a specialist workshop.

Possible cause:

The drop sensor is not available.

- Seek the advice of a specialist workshop, preferably an authorised BMW Motorrad dealer.

## Emergency call function restricted

– with intelligent emergency call<sup>OE</sup>

 Intell. emerg. call failure. Have it checked by a specialist workshop.

Possible cause:

The emergency call cannot be made automatically or via BMW.

- Find information on operating the intelligent emergency call from page (▣▣▣ 69).
- Seek the advice of a specialist workshop, preferably an authorised BMW Motorrad dealer.

### Side stand monitoring is faulty



Side stand monitoring faulty. Onward journey possible. Engine stop. when stationary! Have checked by workshop.

Possible cause:

The side-stand switch or its wiring are damaged.

- Seek the advice of a specialist workshop, preferably an authorised BMW Motorrad dealer.

### ABS self-diagnosis not completed



ABS telltale and warning light flashes.

Possible cause:



ABS self-diagnosis not completed

The ABS function is not available, because self-diagnosis did not complete. (The motorcycle has to reach a defined minimum speed for the wheel speed sensors to be checked: 5 km/h)

- Pull away slowly. Bear in mind that the ABS function is not available until self-diagnosis has completed.

### ABS deactivated



ABS indicator and warning light shows.



Off!



ABS deactivated.

Possible cause:

The rider has switched off the ABS system.

- Activating the ABS function (▣▣▣ 77).

### ABS fault



ABS indicator and warning light shows.



Limited ABS availability! Riding at mod. speed pos. Ride carefully to next specialist workshop.

Possible cause:

The ABS control unit has detected a fault. The partially integral function and the Dynamic Brake Control function



have failed. The ABS function has limited availability.

- You can continue to ride. Pay attention to the more detailed information on certain situations that can lead to an ABS fault message (►► 157).
- Have the fault rectified as quickly as possible by a specialist workshop, preferably an authorised BMW Motorrad Retailer.

### ABS failed



ABS indicator and warning light shows.



ABS failure! Riding at mod. speed pos. Ride carefully to next specialist workshop.

Possible cause:

The ABS control unit has detected a fault. The ABS function is not available.

- You can continue to ride. Pay attention to the more detailed information on certain situations that can lead to an ABS fault message (►► 157).
- Have the fault rectified as quickly as possible by a specialist workshop, preferably an authorised BMW Motorrad dealer.

### ABS Pro failed

– with riding modes Pro<sup>OE</sup>



ABS indicator and warning light shows.



ABS Pro failure! Riding at mod. speed pos. Ride carefully to next specialist workshop.

Possible cause:

The ABS Pro control unit has detected a fault. The ABS Pro function is not available. The ABS function is still available.

ABS provides support only for braking in straight-ahead driving.

- You can continue to ride. Bear in mind the more detailed information on certain situations that can lead to an ABS Pro fault message (►► 157).
- Have the fault rectified as quickly as possible by a specialist workshop, preferably an authorised BMW Motorrad dealer.

### ASC/DTC intervention



ASC/DTC indicator and warning light flashes

quickly.

The ASC/DTC has detected a degree of instability at the rear wheel and has intervened to reduce torque. The indicator and warning light flashes longer than the ASC/DTC intervention lasts. This affords the rider visual feedback on control intervention even

after the critical situation has been dealt with.

### ASC/DTC self-diagnosis not completed



ASC/DTC indicator and warning light flashes slowly.

Possible cause:



ASC/DTC self-diagnosis not completed

The ASC/DTC function is not available, because self-diagnosis did not complete. (The motorcycle has to reach a defined minimum speed with the engine running for the wheel-speed sensors to be checked: min 5 km/h)

- Pull away slowly. The ASC/DTC indicator and warning light must go out after a few metres. If the ASC/DTC indicator and warning light continues flashing:

- Seek the advice of a specialist workshop, preferably an authorised BMW Motorrad dealer.

### ASC/DTC switched off



ASC/DTC indicator and warning light comes on.



Off!



Traction control deactivated.

Possible cause:

The rider has switched off the ASC/DTC system.

- Switch on the ASC/DTC function (☛ 79).

### ASC/DTC restricted



ASC/DTC indicator and warning light comes on.



Traction control limited! Riding at mod. speed pos. Ride carefully

to next specialist workshop.

Possible cause:

The ASC/DTC control unit has detected a fault.



### ATTENTION

#### Damaged components

Damage to sensors, for example, which causes malfunctions

- Do not transport any objects underneath the driver or passenger seat.
- Secure the toolkit. ◀
- Do not damage the angular rate sensor.
- Bear in mind that the ASC/DTC function is restricted.
- You can continue to ride. Take note of the more detailed information on situations that can lead to an ASC/DTC fault (☛ 160).
- Have the fault rectified as quickly as possible by a

specialist workshop, preferably an authorised BMW Motorrad Retailer.

### ASC/DTC fault



ASC/DTC indicator and warning light comes on.



Traction control failure! Riding at mod. speed pos. Ride carefully to next specialist workshop.

Possible cause:

The ASC/DTC control unit has detected a fault.



### ATTENTION

#### Damaged components

Damage to sensors, for example, which causes malfunctions

- Do not transport any objects underneath the driver or passenger seat.
- Secure the toolkit. ◀

- Do not damage the angular rate sensor.
- Bear in mind that the ASC/DTC function is not available or the functionality is subject to certain restrictions.
- You can continue to ride. Take note of the more detailed information on situations that can lead to an ASC/DTC fault (▶▶▶ 160).
- Have the fault rectified as quickly as possible by a specialist workshop, preferably an authorised BMW Motorrad Retailer.

### D-ESA fault



General warning light shows yellow.



Spring strut adjustment faulty! Riding at mod. speed pos. Ride carefully to next specialist workshop.

Possible cause:

The D-ESA control unit has detected a fault. The damping and/or spring adjuster may be the cause. In Auto the cause may also be a fault in the riding position equaliser. In this condition, the motorcycle may have too much damping and is uncomfortable to drive, especially on roads in poor condition. Alternatively, the spring preload may be incorrectly adjusted.

- Have the fault rectified as quickly as possible by a specialist workshop, preferably an authorised BMW Motorrad dealer.

### Fuel down to reserve



Fuel reserve reached. Go to a filling station soon.

**WARNING****Irregular engine operation or engine shutdown due to lack of fuel**

Risk of accident, damage to catalytic converter

- Do not run the fuel tank dry. ◀

Possible cause:

The fuel tank contains no more than the reserve quantity of fuel.



Reserve fuel

approx. 4 l

- Refuelling (▶▶▶▶ 149).

**Hill Start Control active**

Green holding symbol is displayed.

Possible cause:

The driver has activated Hill Start Control (▶▶▶▶ 168).

- Switch off Hill Start Control.
- Operate Hill Start Control (▶▶▶▶ 89).

**Hill Start Control automatically deactivated**

Yellow holding symbol flashes.

Possible cause:

Hill Start Control has been automatically deactivated.

- Side stand has been folded out.
  - » Hill Start Control is deactivated when the side stand is folded out.
- Engine has been switched off.
  - » Hill Start Control is deactivated when the engine is switched off.
- Operate Hill Start Control (▶▶▶▶ 89).

**Hill Start Control cannot be activated**

Crossed-out holding symbol is displayed.

Possible cause:

Hill Start Control cannot be activated.

- Retract the side stand.
  - » Hill Start Control functions only when the side stands are folded in.
- Start the engine.
  - » Hill Start Control functions only when the engine is running.

**Gear not trained**

– with shift assistant Pro<sup>OE</sup>



The gear indicator flashes.  
The Pro shift assistant is not available.

Possible cause:

– with shift assistant Pro<sup>OE</sup>

The gearbox sensor is not fully trained.

- Engage neutral gear N and, with the vehicle at a standstill, let the engine run for at least 10 seconds to train the idle gear.
- Engage all gears with clutch actuation and ride at least 10 seconds with the engaged gear.
- » The gear indicator starts to flash when the gearbox sensor has been trained successfully.
- When the gearbox sensor is fully trained, the Pro shift assistant functions as described (▶▶▶ 167).
- If the training process was not successful, have the fault rectified by a specialist workshop, preferably an authorised BMW Motorrad dealer.

## Hazard warning lights system is switched on



Turn signal indicator light flashes green.



Turn signal indicator light flashes green.

Possible cause:

The driver has switched on the hazard warning lights system.

- Operating hazard warning flashers (▶▶▶ 74).

## Service-due indicator



If service is overdue, the due date or the odometer reading at which service was due is accompanied by the 'General' warning light showing yellow.

If the service is overdue, a yellow CC message is displayed. Exclamation marks also draw attention to the displays for service, service appointment and remaining distance in the MY VEHICLE

and SERVICE REQUIREMENTS menu screens.



## NOTICE

If the service-due indicator appears more than a month before the service date, the current date has to be corrected. This situation can occur if the battery was disconnected.◀

## Service due



is displayed in white.

Service due! Have service performed by a specialist workshop.

Possible cause:

Service is due because of the driving performance or the date.

- Have your motorcycle serviced regularly by a specialist workshop, preferably by an authorised BMW Motorrad retailer.

- » The operational and road safety of the motorcycle remain intact.
  - » The motorcycle's value is maintained as best as possible.
- » The operational and road safety of the motorcycle remain intact.
  - » The motorcycle's value is maintained as best as possible.

### Service-due date has passed



General warning light shows yellow.



is displayed in yellow.

Service overdue! Have service performed by a specialist workshop.

Possible cause:

Service is overdue because of the driving performance or the date.

- Have your motorcycle serviced regularly by a specialist workshop, preferably by an authorised BMW Motorrad retailer.

## Operation

Ignition switch/steering lock .....	62	Hill Start Control .....	89
Ignition with Keyless Ride .....	64	Anti-theft alarm (DWA) .....	92
Emergency off switch (kill switch) .....	68	Tyre pressure monitoring (RDC) ....	95
Intelligent emergency call .....	68	Heated handlebar grips .....	95
Lights .....	71	Front and rear seats .....	96
Day run lights .....	72	Stowage compartment .....	99
Hazard warning lights system .....	74		
Turn indicators .....	75		
Antilock Brake System (ABS) .....	76		
Traction control (ASC/DTC) .....	78		
Electronic Suspension Adjustment (D-ESA) .....	79		
Riding mode .....	82		
PRO riding mode .....	85		
Cruise-control system .....	87		

## Ignition switch/steering lock

### Keys

You receive 2 ignition keys. Please consult the information on the electronic immobiliser (EWS) if a key is lost or mislaid (►► 63). Ignition switch/steering lock, fuel filler cap lock and seat lock are all operated with the same key.

If you wish you can arrange to have the cases and the top-case fitted with locks that can be opened with the ignition key as well. Consult a specialist workshop, preferably an authorised BMW Motorrad Retailer.

### Lock the handlebars

- Turn the handlebars all the way to left.

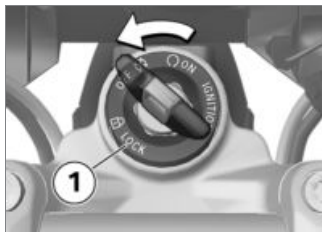

- Turn the key to position **1**, while moving the handlebars slightly.
  - » Ignition, lights and all function circuits switched off.
  - » Handlebars are locked.
  - » Key can be removed.

## Switching on ignition

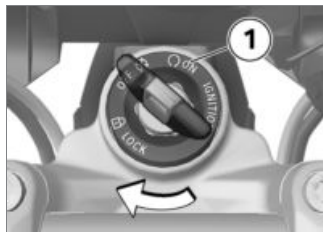

- Insert the key in the ignition switch and turn to position **1**.
  - » Side lights and all function circuits are switched on.
  - » Pre-Ride-Check is performed. (►► 140)
  - » ABS self-diagnosis is in progress. (►► 140)
    - without riding modes Pro<sup>OE</sup>
  - » ASC self-diagnosis is performed. (►► 141)<
  - with riding modes Pro<sup>OE</sup>
  - » DTC self-diagnosis is in progress. (►► 141)<



## Welcome lights

- Switch on the ignition.
  - » The side lights briefly light up.
  - with daytime riding light<sup>OE</sup>
  - » The daytime riding lights briefly light up.◁

## Switching off ignition

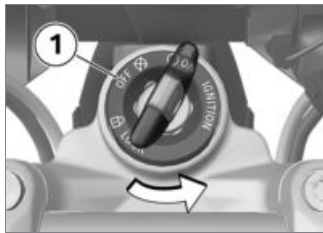

- Turn the ignition key to position **1**.
  - » When the ignition is switched off, the instrument cluster remains switched on for a short time and displays any existing fault messages.
  - » Handlebars not locked.

- » Electrically powered accessories remain operational for a limited period of time.
- » The battery can be recharged via the socket.
- » Key can be removed.
- with LED additional headlight<sup>OA</sup>
  - The LED auxiliary headlights go out soon after the ignition is switched off.◁

## Electronic immobiliser EWS

The electronic design of the motorcycle allows it to access data stored in the ignition key by means of a ring antenna located in the ignition switch/steering lock. The engine control unit will not permit the engine to be started unless the key is identified as “authorised”.

## NOTICE

A spare key attached to the same ring as the ignition key used to start the engine could “irritate” the electronics, in which case the enabling signal for starting is not issued. Always keep the spare key separately from the ignition key.◀

If you lose your key, you can have it barred by your authorised BMW Motorrad dealer. If you wish to do this, you will need to bring all other keys for the motorcycle with you. The engine cannot be started by a barred key, but a key that has been barred can subsequently be reactivated. You can obtain emergency/extra keys only through an authorised BMW Motorrad dealer. The keys are part of an integrated security system, so the dealer is under an

obligation to check the legitimacy of all applications for replacement/extra keys.

## Ignition with Keyless Ride

– with Keyless Ride<sup>OE</sup>

### Keys

#### NOTICE

The telltale light for the radio-operated key flashes while the search for the radio-operated key is in progress.

The telltale light goes out as soon as the radio-operated key or the emergency key is found. The telltale light goes out briefly if the search times out without the radio-operated key or the emergency key being found. ◀

You receive one radio-operated key and one emergency key. Please consult the information on

the electronic immobiliser (EWS) if a key is lost or misplaced (▶▶▶ 63). Ignition, fuel filler cap and anti-theft alarm system all work with the radio-operated key. Seat lock, topcase and cases can be locked and unlocked manually.

#### NOTICE

The vehicle cannot be started if the radio control key is not within range (e.g. key inside one of the cases or the topcase). If the radio-operated key remains out of range the ignition is switched off after about 1.5 minutes to protect the battery. It is advisable to keep the radio-operated key closely on your person (e.g. in a jacket pocket) and to have the emergency key with you as an alternative. ◀

	Range of the Keyless Ride radio-operated key
– with Keyless Ride <sup>OE</sup>	
approx. 1 m ◀	

## Lock the handlebars Requirement

The handlebars are turned towards the left. Radio-operated key is within range.



- Press and hold down button **1**.
- » The steering lock engages with an audible click.

- » Ignition, lights and all function circuits switched off.
- To unlock the steering lock, briefly press button **1**.

## Switching on ignition Requirement

Radio-operated key is within range.

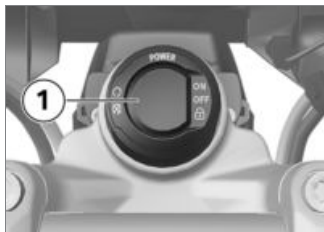

- There are **two** ways of activating the ignition.

### Version 1:

- Briefly press button **1**.
- » Side lights and all function circuits are switched on.

- with daytime riding light<sup>OE</sup>
  - » Daytime riding light is switched on.◁
  - » Pre-Ride-Check is performed. (▣▣▣ 140)
  - » ABS self-diagnosis is in progress. (▣▣▣ 140)
- without riding modes Pro<sup>OE</sup>
  - » ASC self-diagnosis is performed. (▣▣▣ 141)◁
- with riding modes Pro<sup>OE</sup>
  - » DTC self-diagnosis is in progress. (▣▣▣ 141)◁

### Version 2:

- Steering lock is engaged; press and hold down button **1**.
- » The steering lock disengages.
- » Parking lights and all function circuits switched on.
- » Pre-Ride-Check is performed. (▣▣▣ 140)
- » ABS self-diagnosis is in progress. (▣▣▣ 140)

- without riding modes Pro<sup>OE</sup>
  - » ASC self-diagnosis is performed. (▣▣▣ 141)◁
- with riding modes Pro<sup>OE</sup>
  - » DTC self-diagnosis is in progress. (▣▣▣ 141)◁

## Switching off ignition Requirement

Radio-operated key is within range.



- There are **two** ways of deactivating the ignition.

**Version 1:**

- Briefly press button **1**.
- » Light is switched off.
- » Handlebars (steering lock) are not locked.

**Version 2:**

- Turn the handlebars all the way to left.
- Press and hold down button **1**.
- » Light is switched off.
- » The steering lock engages.

**Electronic immobiliser EWS**

The on-board electronics access the data saved in the radio-operated key via a ring aerial in the wireless lock. The ignition is not enabled for starting until the engine control unit has recognised the radio-operated key as "authorised" for your motorcycle.

**NOTICE**

A spare key attached to the same ring as the radio-operated key used to start the engine could 'irritate' the electronics, in which case the enabling signal for starting is not issued.

Always keep the spare key separate from the radio-operated key. ◀

If you mislay a radio-operated key you can have the key in question barred by your authorised BMW Motorrad dealer. In order to have a key barred you must bring along all the other keys belonging to the motorcycle.

The engine cannot be started by a barred radio-operated key, but a radio-operated key that has been barred can subsequently be reactivated.

You can obtain emergency/extra keys only through an author-

ised BMW Motorrad dealer. The radio-operated keys are part of an integrated security system, so the dealer is under an obligation to check the legitimacy of all applications for replacement/extra keys.

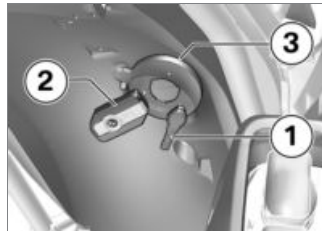
**Battery of the radio-operated key is empty or loss of the radio-operated key**

- Please consult the information on the electronic immobiliser (**EWS**) if a key is lost or mislaid.

- If you happen to lose or mislay the radio-operated key while on a journey, you can start the vehicle with the emergency key.
- If the battery of the radio-operated key is empty, touching the radio-operated key against the rear-wheel cover will start the engine.
- Hold emergency key **1** or radio-operated key with empty battery **2** at the rear-wheel cover level with aerial **3**.



## NOTICE

The emergency key or the radio-operated key with the empty battery must be **in contact with** the rear-wheel cover. ◀

	<p>Time during which the engine has to be started. The unlocking procedure has to be repeated if this time is allowed to expire.</p>
<p>30 s</p>	

- » Pre-ride check is performed.
- Key has been recognised.
- Engine can be started.
- Starting the engine (☰➔ 139).

## Replace the battery of the radio-operated key

If the radio-operated key does not react when you short-press or long-press a button:

- The battery in the radio-operated key is not at full capacity.



Remote key battery weak. Limited central locking function. Change battery.

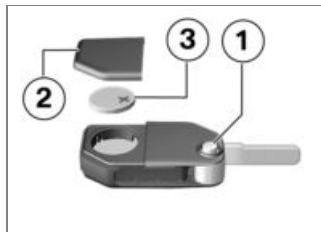

- Press button **1**.
- » Key bit flips out.
- Push up battery cover **2**.
- Remove the battery **3**.
- Dispose of the old battery in accordance with all applicable laws and regulations; do not attempt to dispose of batteries as domestic waste.



## ATTENTION

**Unsuitable or incorrectly inserted batteries**  
Component damage

- Use a battery compliant with the manufacturer's specifications.
- When inserting the battery, always make sure polarity is correct. ◀
- Insert the new battery with the positive terminal up.



Battery type

For Keyless Ride radio-operated key

CR 2032

- Remove the battery **2**.
- » Red LED on the instrument panel flashes.
- » The radio-operated key is ready for use again.

## Emergency off switch (kill switch)

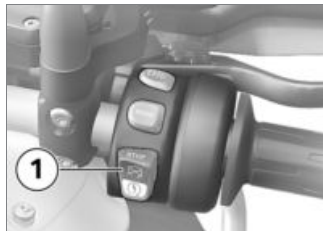

- 1** Emergency off switch (kill switch)



### WARNING

#### Operation of the kill switch while riding

Risk of fall due to rear wheel locking

- Do not operate the kill switch when riding. ◀

The emergency off switch is a kill switch for switching off the engine quickly and easily.

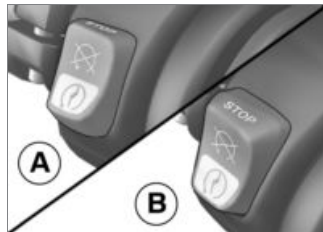

- A** Engine switched off  
**B** Normal operating position (run)

## Intelligent emergency call

- with intelligent emergency call<sup>OE</sup>

## Emergency call via BMW

Press the SOS button in an emergency only.

Even if an emergency call using BMW is not possible, the system may make an emergency call to a public emergency call number. This depends on the respective mobile phone network and the national regulations.

The emergency call is not able to be ensured because of technical reasons due to unfavourable conditions, e.g. in areas where there is no mobile phone reception.

## Language for emergency call

Each vehicle has a language assigned to it depending on the market for which it is intended. The BMW Call Center answers in this language.

### NOTICE

The language for the emergency call can only be changed by the BMW Motorrad partner. The language assigned to the vehicle differs from the display languages that can be selected by the rider in the TFT display. ◀

## Manual emergency call Requirement

An emergency call has occurred. The vehicle is at a standstill. The ignition is switched on.



- Open cover **1**.
- Briefly press SOS button **2**.

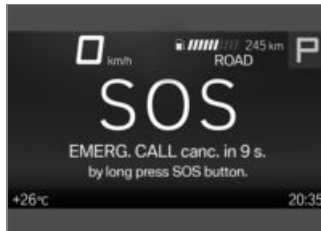

The time until transmission of an emergency call is displayed. During that time, it is possible to cancel the emergency call.

- Operate the emergency-off switch to stop the engine.
- Remove helmet.
- » After expiry of the timer, a voice contact to the BMW Call Center is established.

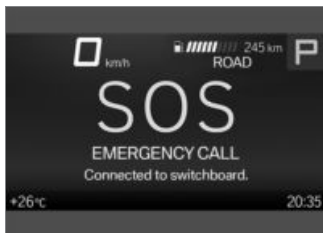

The connection was established.



- Provide information to the emergency services using the microphone **3** and speaker **4**.

### Automatic emergency call

The intelligent emergency call is active after the ignition is switched on and reacts if a fall or crash occurs.

### Emergency call in the event of a light fall

- A minor fall or a crash is detected.
- » An acoustic signal is sounded.

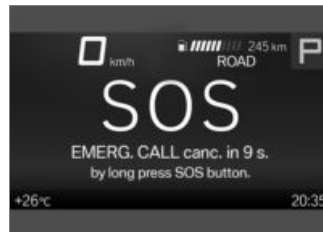

The time until transmission of an emergency call is displayed. During that time, it is possible to cancel the emergency call.

- If possible, remove helmet and stop engine.
- » A voice contact connection to the BMW Call Center is established.



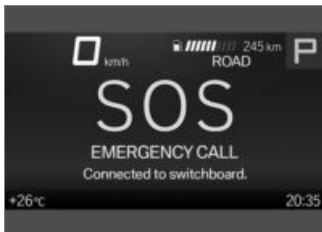

The connection was established.

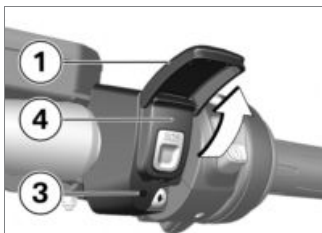

- Open cover **1**.
- Provide information to the emergency services using the microphone **3** and speaker **4**.

## Emergency call in the event of a severe fall

- A severe fall or a crash is detected.
  - » The emergency call is placed automatically without delay.

## Lights

### Low-beam headlight and sidelights

The side lights switch on automatically when the ignition is switched on.



#### NOTICE

The side lights place a strain on the battery. Do not switch the ignition on for longer than absolutely necessary. ◀

The low-beam headlight switches on automatically when the engine is started.

– with daytime riding light<sup>OE</sup>  
In daytime the daytime riding light can be switched on as an alternative to the low-beam headlight.

### High-beam headlight and headlight flasher

- Switching on ignition (▶▶ 62).

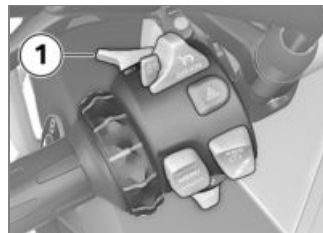

- Push switch **1** forward to switch on the high-beam headlight.
- Pull switch **1** back to operate the headlight flasher.

## Parking lights

- Switching off ignition (☞ 63).



- Immediately after switching off the ignition, push button **1** to the left and hold it in that position until the parking lights come on.
- Switch the ignition on and off again to switch off the parking lights.

## Auxiliary headlights

- with LED additional headlight<sup>OA</sup>

## Requirement

The additional headlights are active only when the low-beam headlight is active.



### NOTICE

The auxiliary headlights have approval as fog lights and their use is permissible in bad weather conditions only. Always comply with the road traffic regulations in force in the country in which the vehicle is used.◀

- Starting the engine (☞ 139).



- Press button **1** to switch on the additional headlights.
- 
 The indicator light for the auxiliary headlight illuminates.
- Press button **1** again to switch off the additional headlights.

## Day run lights

- with daytime riding light<sup>OE</sup>

## Manual daytime riding light

### Requirement

Automatic daytime riding light is switched off.

### WARNING

#### Switching on the daytime riding light in the dark.

Risk of accident

- Do not use the daytime riding light in the dark. ◀

### NOTICE

By comparison with the low-beam headlight, the daytime running light makes the vehicle more visible to oncoming traffic. This improves daytime visibility. ◀

- Starting the engine (➡ 139).
- In the **Settings, Vehicle settings, Lights** menu,

switch off the **Auto. dayt. rid. light** function.



- Press button **1** to switch on the daytime riding light.

 The indicator light for the daytime riding light lights up.

- » The low-beam headlight and the front side lights are switched off.
- In the dark or in tunnels: Press button **1** again to switch off the daytime riding light and switch on the low-beam headlight and front side light.

### NOTICE

If the high-beam headlight is switched on while the daytime riding light is on, the daytime riding light is switched off after approx. 2 seconds and the high-beam headlight, low-beam headlight and front side light are switched on.

If the high beam headlight is switched off again, the daytime running light is not automatically reactivated, but must be switched on again if required. ◀

## Automatic daytime riding light

### NOTICE

The changeover between daytime riding light and low-beam headlight including front side lights can be effected automatically. ◀

**WARNING****The automatic daytime riding light does not replace the personal assessment of the light conditions**

Risk of accident

- Switch off the automatic daytime riding light in poor light conditions. ◀
- In the *Settings, Vehicle settings, Lights* menu, switch on the *Auto. dayt. rid. light* function.



The indicator light for the automatic daytime riding light lights up.

- » If the ambient brightness decreases below a certain value, the low beam headlight is automatically switched on (e. B. in a tunnel). When sufficient ambient brightness is detected, the

daytime riding light is switched back on.



The indicator light for the daytime riding light shows if the daytime riding light is active.

**Manual operation of the light when the automatic system is switched on**

- If you press the button for the daytime riding light the daytime riding light is switched off and the low-beam headlight and front side lights are switched on (e. g. when you ride into a tunnel, and the response of the automatic daytime riding light to the change in ambient brightness is delayed).
- If you press the button again the daytime riding light is re-activated, in other words the daytime riding light is switched on again when ambient light is bright enough.

**Hazard warning lights system****Operating hazard warning flashers**

- Switching on ignition (▶▶▶ 62).

**NOTICE**

The hazard warning flashers place a strain on the battery. Do not use the hazard warning flashers for longer than absolutely necessary. ◀



- Press button **1** to switch on the hazard warning lights system.
- » Ignition can be switched off.
- To switch off the hazard warning lights system, switch on the ignition if necessary and press button **1** again.

## Turn indicators

### Operating the turn indicators

- Switching on ignition (▣▣▣▣➔ 62).



- Press button **1** to the left to switch on the left turn indicator.
- Press button **1** to the right to switch on the right turn indicator.
- Operate button **1** in the centre position to switch off the turn indicator.

## Comfort turn indicator



If button **1** has been pressed to the right or left, the turn indicators are automatically switched off under the following circumstances:

- Speed below 30 km/h: after 50 m distance covered.
- Speed between 30 km/h and 100 km/h: after a speed-dependent distance covered or in case of acceleration.
- Speed over 100 km/h: after flashing five times.

If button **1** is pressed to the right or left slightly longer, the turn in-

dicators only switch off automatically once the speed-dependent distance covered is reached.

## Antilock Brake System (ABS)

### Deactivating the ABS function

- Switching on ignition (➡ 62).



#### NOTICE

You have the option of deactivating the ABS function while the motorcycle is on the move. ◀



- Press and hold button **1** until the ABS indicator and warning light changes its display behaviour.

Immediately after the button **1** is pressed, the system statuses for ASC/DTC and ABS are displayed as ON.

- » First the ASC indicator and warning light changes its display behaviour. Press and hold down button **1** until the ABS indicator and warning light responds. Under these circumstances, there is no

change in the ASC/DTC setting.



ABS indicator and warning light shows.

Possible ABS system status OFF! is displayed.

- Release button **1** after the ABS system status changes over.

The ASC/DTC system status remains unchanged and a new ABS system status OFF! is briefly displayed.



ABS indicator and warning light remains on.

- » The ABS function is switched off.
- » The integral function remains active.
- » Hill Start Control is still activated.
- with riding modes Pro<sup>OE</sup>
- » Hill Start Control Pro is still activated. ◀

- with riding modes Pro<sup>OE</sup>
  - » The function of the Dynamic Brake Control is also switched off when the ABS function is switched off.◁
- See the section entitled "Engineering details" for more information on brake systems with BMW Motorrad Integral ABS:
  - » Partially integral brakes (▶▶▶ 156)
  - » Hill Start Control function (▶▶▶ 168)
- with riding modes Pro<sup>OE</sup>
  - » Dynamic Brake Control function (▶▶▶ 164)◁

## Activating the ABS function



- Press and hold button **1** until the ABS indicator and warning light changes its status. Immediately after the button **1** is pressed, the system statuses for ASC/DC and ABS are displayed as OFF!.

 ABS telltale and warning light goes out; if self-diagnosis has not completed, it starts flashing.

Possible ABS system status ON is displayed.

- Release button **1** once the ABS system status has changed.  ABS indicator and warning light remains off or continues to flash.

The ASC/DC system status remains unchanged and a new ABS system status ON is briefly displayed.

- » The ABS function is switched on.
- You also have the option of switching the ignition off and then on again.



An ABS fault has occurred if the ABS telltale and warning light shows when the motorcycle accelerates to a speed in excess of the minimum stated below after the ignition was switched off and then on again.

min 10 km/h

- with riding modes Pro<sup>OE</sup>
- If the encoding plug is not inserted, you have the alternative of switching the ignition off and back on again.<

## Traction control (ASC/DTC)

### Switch off the ASC/DTC function

- Switching on ignition (➡ 62).



### NOTICE

You have the option of deactivating the ASC/DTC function while the motorcycle is on the move.<



- Press and hold button **1** until the ASC/DTC indicator and warning light changes its display behaviour.

Immediately after button **1** is pressed, ASC/DTC system status **ON** and current ABS system status are displayed.



ASC/DTC indicator and warning light comes on.

Possible ASC/DTC system status **OFF!** is displayed.

- Release button **1** after the ASC/DTC system status changes.

The new ASC/DTC system status **OFF!** is displayed briefly. The ABS system status remains unchanged.



ASC/DTC indicator and warning light remains on.

- » The ASC/DTC function is switched off.



## Switch on the ASC/DTC function



- Press and hold button **1** until the ASC/DTC indicator and warning light changes its display behaviour.

Immediately after button **1** is pressed, ASC/DTC system status **OFF!** and current ABS system status are displayed.

 ASC/DTC indicator and warning light goes out; if self-diagnosis has not been completed, it starts to flash.

Possible ASC system status **ON** is displayed.

- Release button **1** once the status has changed.

 ASC indicator and warning light remains off or continues flashing.

Possible ASC/DTC system status **ON** is displayed.

- » The ASC/DTC function is switched on.
  - without riding modes Pro<sup>OE</sup>
- Alternatively, switch the ignition off and on again.<
- with riding modes Pro<sup>OE</sup>
- If the coding plug is not inserted, you have the alternative of switching the ignition off and then on again.
- See the section entitled "Engineering details" for more in-

formation on traction control (ASC/DTC):

- » How does traction control work? (➡ 159)

## Electronic Suspension Adjustment (D-ESA)

– with Dynamic ESA<sup>OE</sup>

### Dynamic ESA possible settings

The electronic chassis and suspension setting Dynamic ESA is able to adjust your motorcycle automatically to the load. If the spring preload is set to **Auto**, the rider does not have to change the load settings.

See the "Engineering details" section for more information on Dynamic ESA (➡ 161).

### Available damping modes

- For on-road mode: Road and Dynamic
- For off-road mode: Enduro

### Available load settings

- Fixed set minimum spring preload: Min
- Activated riding position equaliser with automatic adjustment of the spring preload: Auto
- Fixed set maximum spring preload: Max



### NOTICE

BMW Motorrad recommends the Auto chassis and suspension setting. ◀

### Viewing suspension settings

- Switching on ignition (➡ 62).



- Press button **1** briefly to view the current setting.

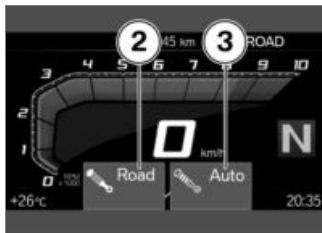

Immediately after pressing the button **1**, the chassis and suspension adjustments for

damping action **2** and spring preload **3** are displayed.

» The setting shows briefly, then disappears automatically.

### Adjusting the chassis and suspension

- Switching on ignition (➡ 62).



- Press button **1** briefly to view the current setting.

To adjust damping:

- Repeatedly press button **1** briefly until the setting you want to use appears on the display.

## NOTICE

You can adjust the damping characteristic while the motorcycle is on the move. ◀



The selection arrow **4** is displayed.

» The selection arrow **4** disappears after the status is changed.

The following settings are available:

- **Road**: damping for comfortable on-road riding

- **Dynamic**: damping action for dynamic on-road riding
- **Enduro**: damping for off-road riding. Only available in **ENDURO** or **ENDURO PRO** riding modes and can also not be adjusted further in these riding modes.

The following message is displayed in the selected riding mode if no setting is possible:  
In **ENDURO** riding mode damp. not adjustable.



To adjust spring preload:

- Starting the engine (▶▶ 139).
- Repeatedly press and hold button **1** until the setting you want to use appears on the display.

## NOTICE

BMW Motorrad recommends the **Auto** setting. **Min** can be used for better ground accessibility and **Max**, for example, for the off-road mode. ◀



## NOTICE

The Min, Auto and Max settings can be chosen only when the vehicle is stationary. ◀

The following message is displayed if no setting is possible:  
Load adjustment only avail. stopped.

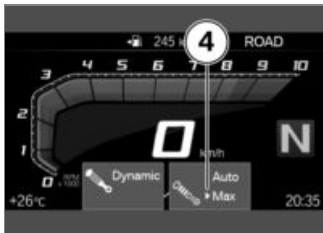

The selection arrow **4** is displayed.

- » The selection arrow **4** disappears after the status is changed.

The following settings are available:

- **Min**: minimum spring preload
- **Auto**: automatic adjustment of the spring preload
- **Max**: maximum spring preload
- » The settings for damping and spring preload shown on the display are automatically accepted if you allow a certain length of time to pass without pressing button **1**.

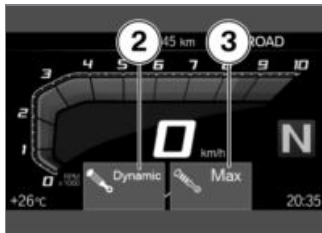

The new chassis and suspension adjustments for damping action **2** and spring preload **3** are briefly displayed.

- If the temperature is very low, take the weight off the motorcycle before increasing spring preload; if applicable, have your passenger dismount.
- » The chassis and suspension settings disappear once adjustment is complete.
- » In **Auto** loading mode, the spring preload is adjusted only once the motorcycle is driven off.

## Riding mode

### Using the riding modes

BMW Motorrad has developed operational scenarios for your motorcycle from which you can select the scenario suitable for your situation:

#### Series

- **RAIN**: Riding on a rain-wet roadway.

– ROAD: Riding on a dry roadway.

– with riding modes Pro<sup>OE</sup>  
**with Pro riding modes**

– DYNAMIC: Dynamic riding on a dry roadway.

– ENDURO Riding off-road with road tyres.

**with Pro riding modes and installed encoding plug**

– DYNAMIC PRO: For dynamic riding on dry roadways while taking into account the settings made by the rider.

– ENDURO PRO: For riding off road with off-road tyres with large tread blocks while taking into account the settings made by the rider.

When an encoding plug is installed, the DYNAMIC PRO and ENDURO PRO riding modes replace DYNAMIC and ENDURO.

The optimum interplay of engine characteristic, ABS control and ASC/DTC is provided for each of these scenarios.

– with Dynamic ESA<sup>OE</sup>

The chassis and suspension adjustment can also be adjusted in the scenario selected.

See the section "Engineering details" for more information on the riding modes (➡ 162).

### Selecting riding mode

- Switching on ignition (➡ 62).



- Press button 1.

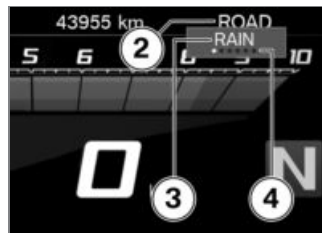

The riding mode currently active 2 is sent to the back and the first selectable riding mode 3 is displayed. The guide 4 displays how many riding modes are available.



### ATTENTION

#### Switching on the off-road mode (ENDURO and ENDURO PRO) in the on-road mode

Crash hazard due to unstable driving conditions during braking and accelerating in the control range of ABS and ASC/DTC

- Switch on the off-road mode (ENDURO and ENDURO PRO) only for riding off road.◀
- Repeatedly press button **1** until the riding mode you want appears on the display.

### NOTICE

With the factory setting, the ABS control for the rear wheel is deactivated when the ENDURO PRO riding mode is active.◀

The following ride modes can be selected:

- RAIN: for riding on a rain-wet road surface.
- ROAD: for riding on a dry roadway.

– with riding modes Pro<sup>OE</sup>

The following riding modes are additionally available for selection:

- DYNAMIC: for dynamic riding on a dry roadway.
- ENDURO: when riding off-road with road tyres.<

– with riding modes Pro<sup>OE</sup>

When an encoding plug is installed, the ENDURO PRO and

DYNAMIC PRO riding modes replace ENDURO and DYNAMIC.

- DYNAMIC PRO: for dynamic riding on dry roadways while taking into account the settings made by the rider.
- ENDURO PRO: for riding off road with off-road tyres with large tread blocks while taking into account the settings made by the rider.<
- » With the motorcycle at a standstill, the selected mode is activated after approximately two seconds.
- » The newly selected riding mode is activated as you ride only when the following preconditions are satisfied:
  - Throttle grip is in the idle position.
  - Brake is not applied.
  - Cruise control is not active.
  - » The mode selected in this way is retained with the engine-

characteristic, ABS, ASC/DTC and Dynamic ESA adaptation settings even after the ignition has been switched off.

## PRO riding mode

– with riding modes Pro<sup>OE</sup>

### Adjustment option

The PRO riding modes can be set individually.

### Setting up PRO riding mode

- Installing encoding plug (▮▮▮ 86).
- Switching on ignition (▮▮▮ 62).
- Call up the **Settings**, **Vehicle settings** menu.
  - » The following PRO riding modes can adapted:
    - ENDURO PRO riding mode
    - DYNAMIC PRO riding mode
- Select and confirm riding mode.

## Enduro Pro adjusting

– with riding modes Pro<sup>OE</sup>

- Setting up PRO riding mode (▮▮▮ 85).

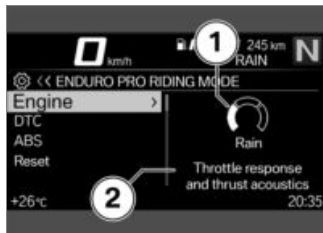

The **Engine** system has been selected. The current setting is displayed as a diagram **1** with explanatory texts relating to the system **2**.

- Select system and confirm.



You can browse through the available settings **3** and the corresponding explanations **4**.

- Set up system.
  - » The **Engine**, **DTC** and **ABS** systems can be set up in the same way.
- The settings can be reset to the factory settings:
- Resetting riding mode settings (▮▮▮ 86).

### Adjusting Dynamic Pro

- Setting up PRO riding mode (▮▮▮ 85).

- Adjust systems in the same way as ENDURO PRO riding mode.

### NOTICE

ABS is only adjustable in the ENDURO PRO riding mode. ◀

## Resetting riding mode settings

- Setting up PRO riding mode (▶▶ 85).
- Select *Reset* and confirm.
  - » The following factory settings apply for ENDURO PRO RIDING MODE:
    - DTC: Enduro Pro
    - ABS: Enduro Pro
    - ENGINE: Road
  - » The following factory settings apply for DYNAMIC PRO RIDING MODE:
    - DTC: Dynamic
    - ENGINE: Dynamic

## Installing encoding plug

- Switching off ignition (▶▶ 63).
- Remove front seat (▶▶ 97).



### ATTENTION

## Dirt and damp penetrating inside open connectors

Malfunctions

- Reinstall the protective cap after removing the coding plug. ◀
- Remove cover cap from plug connection **1**.



- To do this, press in lock **1** and pull off cap.
- Insert encoding plug.
- Switch on the ignition.



The symbol for the encoding plug **1** is displayed. The ENDURO PRO and DYNAMIC PRO riding



modes can be selected and replace the **ENDURO** and **DYNAMIC** riding modes.

- Installing front seat (➡ 98).

## Cruise-control system

– with cruise control<sup>OE</sup>

### Display when adjusting settings (Speed Limit Info not active)



The symbol **1** for cruise control is displayed in the Pure Ride view and the top status line.

### Display when adjusting settings (Speed Limit Info active)



The symbol **1** for cruise control is displayed in the Pure Ride view and the top status line.

### Switching on cruise control

#### Requirement

Cruise control is available only after changing out of the **ENDURO** or **ENDURO PRO** riding modes.



- Slide switch **1** to the right.  
» Button **2** is enabled for operation.

### Saving road speed



- Briefly push button **1** forward.



Adjustment range for speed control

30...210 km/h



Indicator light for cruise control lights up.

- » The motorcycle maintains your current cruising speed and the setting is saved.

### Accelerating

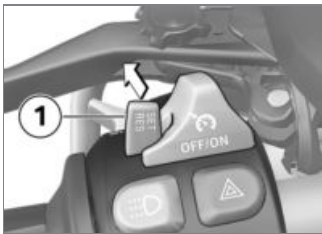

- Briefly push button **1** forward.
- » Speed is increased by approx. 1 km/h each time you push the button.

- Push button **1** forward and hold it in this position.
- » The motorcycle accelerates with infinite variability (no steps)..
- » The current speed is maintained and saved if button **1** is not pushed again.

### Decelerating



- Briefly push button **1** back.
- » Speed is reduced by approx. 1 km/h each time you push the button.
- Push button **1** back and hold it in this position.

- » The motorcycle decelerates with infinite variability (no steps).
- » The current speed is maintained and saved if button **1** is not pushed again.

### Deactivating cruise control

- Brake, pull the clutch lever or turn the throttle twistgrip (close the throttle by turning the twistgrip back past the idle position) to deactivate cruise control.



#### NOTICE

Whenever the Pro shift assistant shifts gears, cruise control is automatically disengaged for safety reasons. ◀



#### NOTICE

For safety reasons, cruise control is deactivated automatically

when the ASC and DTC systems intervene.◀

» Indicator light for cruise control goes out.

## Resuming former cruising speed

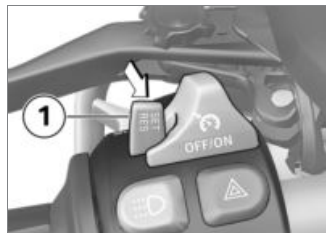

- Briefly push button **1** back to return to the speed saved beforehand.

### NOTICE

Opening the throttle does not deactivate the cruise-control system. If you release the twistgrip the motorcycle will decelerate

only to the cruising speed saved in memory, even though you might have intended slowing to a lower speed.◀



Indicator light for cruise control lights up.

## Switching off cruise control



- Slide switch **1** to the left.
  - » The system is deactivated.
  - » Button **2** is disabled.

## Hill Start Control

### Reading

– with riding modes Pro<sup>OE</sup>

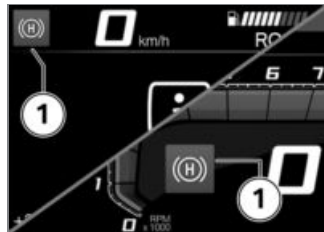

The symbol **1** for drive-off assistant is displayed in the Pure Ride view and the top status line.◀

### Operate Hill Start Control Requirement

The vehicle is at a standstill.

### ATTENTION

**Failure of the drive-off assistant**

Risk of accident

- Secure the vehicle by braking manually.◀

## NOTICE

Hill Start Control is purely a comfort system to facilitate holding the machine and pulling way on uphill gradients and should not be confused with a parking brake.◀

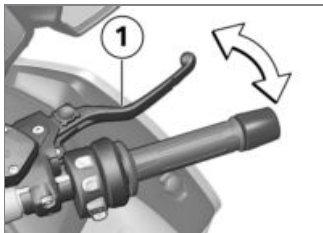

- Operate the brake lever **1** or footbrake lever strongly and release again quickly.

 Green holding symbol is displayed.

» Hill Start Control has been activated.

- To switch off Hill Start Control, operate the brake lever **1** or footbrake lever again.

 The holding symbol disappears.

- Alternatively, ride off in 1st or 2nd gear.

## NOTICE

When riding off, Hill Start Control is automatically deactivated.◀

 Once the brake has been fully released, the holding symbol disappears.

- » Hill Start Control is deactivated.
- See the "Engineering details" section for more information on Hill Start Control:

» Hill Start Control function (▶▶▶ 168)

## Switching Hill Start Control on or off

- Switching on ignition (▶▶▶ 62).
- Call up the `Settings`, `Vehicle settings` menu.
- Switch `Hill Start Control` on or off.

## Operating Hill Start Control Pro

– with riding modes Pro<sup>OE</sup>

## ATTENTION

### Failure of the drive-off assistant

Risk of accident

- Secure the vehicle by braking manually.◀

## NOTICE

The drive-off assistant Hill Start Control Pro is only a comfort system to enable easier riding off on gradients and should not be confused with an electromechanical holding brake. ◀

## NOTICE

The Hill Start Control Pro drive-off assistant should not be used on inclines of over 40 %. ◀

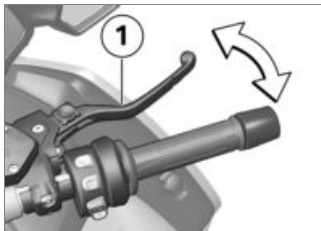

- Operate the brake lever **1** or footbrake lever strongly and release again quickly.
- Alternatively, apply the brake for about one second beyond the vehicle reaching a standstill on an incline of at least 5 %.



Green holding symbol is displayed.

- » Hill Start Control Pro is activated.
- To switch off the Hill Start Control Pro, operate the brake lever **1** or footbrake lever again.

## NOTICE

If Hill Start Control Pro has been deactivated using the brake lever, automatic Hill Start Control is deactivated for the next 4 m. ◀



The holding symbol disappears.

- Alternatively, ride off in 1st or 2nd gear.

## NOTICE

When riding off, Hill Start Control Pro is automatically deactivated. ◀



Once the brake has been fully released, the holding symbol disappears.

- » Hill Start Control Pro is deactivated.
- See the "Engineering details" section for more information on Hill Start Control Pro:

- » Hill Start Control function (▣▣▣ 168)

## Adjusting Hill Start Control Pro

– with riding modes Pro<sup>OE</sup>

- Switching on ignition (▣▣▣ 62).
- Call up the **Settings**, **Vehicle settings** menu.
- Select **Hill Start Control Pro**.
- To switch off Hill Start Control Pro, select **Off**.
- » Hill Start Control Pro is deactivated.
- To switch on manual Hill Start Control Pro, select **Manual**.
- » Hill Start Control Pro can be activated by forcefully operating the handbrake or footbrake lever.
- To switch on automatic Hill Start Control Pro, select **Auto**.
- » Hill Start Control Pro can be activated by forcefully operat-

ing the handbrake or footbrake lever.

- » If the brake is actuated for approximately one second after the vehicle has come to a standstill and the motorcycle is on a gradient of at least 5%, Hill Start Control Pro is automatically activated.
- » The selected setting remains stored even after the ignition is switched off.

## Anti-theft alarm (DWA) Activation

– with anti-theft alarm (DWA)<sup>OE</sup>

- Switching on ignition (▣▣▣ 62).
- Customising anti-theft alarm settings (▣▣▣ 94).
- Switch off the ignition.
- » If the alarm system is activated, then the alarm system will be automatically activated when the ignition is switched off.

- » Activation takes approximately 30 seconds to complete.
  - » Turn indicators flash twice.
  - » Confirmation tone sounds twice (if programmed).
  - » Anti-theft alarm is active.
- with Keyless Ride<sup>OE</sup>

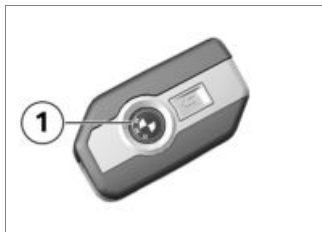

- Switch off the ignition.
- Press button **1** on the radio-operated key twice.
- » Activation takes approximately 30 seconds to complete.
- » Turn indicators flash twice.
- » Confirmation tone sounds twice (if programmed).

» Anti-theft alarm is active.

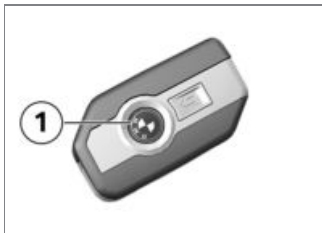

- Press button **1** again on the radio-operated key during the activation phase to deactivate the motion sensor (e.g. to transport the motorcycle by train when the severe movements may activate the alarm).
- » Turn indicators flash three times.
- » Confirmation tone sounds three times (if programmed).
- » Motion sensor has been deactivated.

## Alarm signal

– with anti-theft alarm (DWA)<sup>OE</sup>

A DWA alarm can be triggered by:

- Motion sensor
- Switch-on attempt with an unauthorised vehicle key.
- Disconnection of the DWA anti-theft alarm from the motorcycle's battery (DWA internal battery provides power - alarm tone only, the turn indicators do not flash)

All functions are sustained even if the internal battery of the DWA anti-theft alarm system is flat; the only difference is that an alarm cannot be triggered if the system is disconnected from the motorcycle's battery.

An alarm lasts for approximately 26 seconds. While an alarm is in progress an alarm tone sounds and the turn indicators flash. The type of alarm tone can be set by an authorised BMW Motorrad dealer.

– with Keyless Ride<sup>OE</sup>

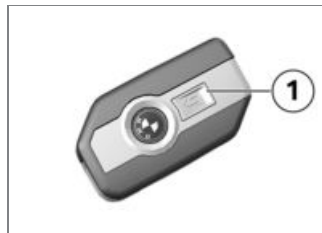

The activated alarm can be aborted at any time by pressing the **1** button on the radio-operated key, without deactivating the anti-theft alarm.

If an alarm was triggered while the motorcycle was unattended, the rider is notified accordingly by an alarm tone sounding once when the ignition is switched on. The DWA LED then indicates the reason for the alarm for one minute.

### Light signals issued by the DWA LED:

- Flashes 1x: Motion sensor 1
- Flashes 2x: Motion sensor 2
- Flashes 3x: Ignition switched on with unauthorised vehicle key
- Flashes 4x: Disconnection of the anti-theft alarm from the motorcycle's battery
- Flashes 5x: Motion sensor 3

### Deactivation

- with anti-theft alarm (DWA)<sup>OE</sup>
  - Kill switch in operating position (run).
  - Switch on the ignition.

- » Turn indicators flash once.
- » Confirmation tone sounds once (if programmed).
- » DWA has been switched off.
- with Keyless Ride<sup>OE</sup>

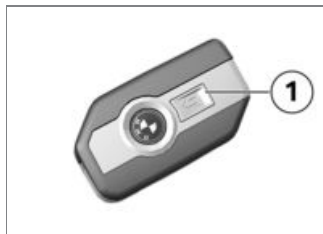

- Press the **1** button on the radio-operated key once.



### NOTICE

The alarm function is reactivated after 30 seconds if "activation after ignition off" has been selected if the alarm function is deactivated using the radio-operated key and the ignition is not then switched on. ◀

- » Turn indicators flash once.
- » Confirmation tone sounds once (if programmed).
- » DWA has been switched off.

### Customising anti-theft alarm settings

- Switching on ignition (▶▶ 62).
- Call up the Settings, Vehicle settings, Alarm system menu.
- » The following settings are available:
  - Adapt warning signal
  - Switch Tilt alarm sensor on or off
  - Switch Arming tone on or off
  - Switch Arm automatically on or off
  - with anti-theft alarm (DWA)<sup>OE</sup>
  - » Possible settings (▶▶ 95)◀



## Possible settings

– with anti-theft alarm (DWA)<sup>OE</sup>

**Warning signal:** set the increasing and decreasing or intermittent alarm tone.

**Tilt alarm sensor:** activate inclination sensor to monitor the inclination of the vehicle. The DWA responds, for example, to wheel theft or being towed away.



### NOTICE

Deactivate the tilt sensor when transporting the vehicle in order to prevent the DWA from tripping. ◀

**Arming tone:** confirmation alarm tone after having activated/deactivated the DWA in addition to flashing turn indicators.

**Arm automatically:** automatic activation of the alarm function when switching off the ignition.

## Tyre pressure monitoring (RDC)

– with riding modes Pro<sup>OE</sup>

### Switching the minimum pressure warning on or off

- The minimum pressure of the tyres can be freely selected. When the minimum pressure is reached, a minimum pressure warning can be displayed.
- Call up the **Settings**, **Vehicle settings**, **RDC** menu.
- Switch **Nom. pressure warning** on or off.

## Heated handlebar grips

– with heated grips<sup>OE</sup>

## Operating the heated handlebar grips



### NOTICE

The heating in the heated handlebar grips can be activated only when the engine is running. ◀



### NOTICE

The increase in power consumption caused by having the heated handlebar grips switched on can drain the battery if you are riding at low engine speeds. If the charge level is low, the heated handlebar grips are switched off to ensure the battery's starting capability. ◀

- Starting the engine (▶▶▶ 139).



- Repeatedly press button **1** until the desired heating level **2** appears in front of the heated grip symbol **3**.

The handlebar grips have two-stage heating.

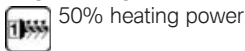

50% heating power



100% heating power

- » Stage 2 is for heating the grips quickly: it is advisable to switch back to stage 1 as soon as the grips are warm.

- » The selected heating stage will be saved if you allow a certain length of time to pass without making further changes.
- To switch off the heated grips, repeatedly press button **1** until the heated grip symbol **3** is hidden.

## Front and rear seats

### Removing rear seat

- Remove front seat (→ 97).

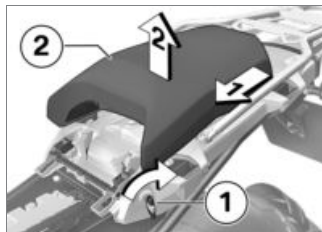

- Turn ignition key **1** clockwise.
- Push rear seat **2** in the forward direction of travel and lift it up to remove

- Place the rear seat, upholstered side down, on a clean surface.

### Installing rear seat

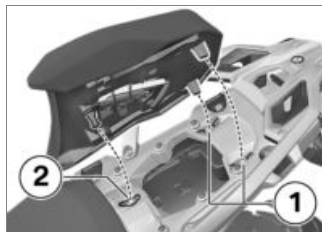

- Centre the rear seat in rear mounts **1** and engage it in front mount **2**.
- Push the rear seat in the direction opposite the forward direction of travel.
- Check that the rear seat is correctly seated.

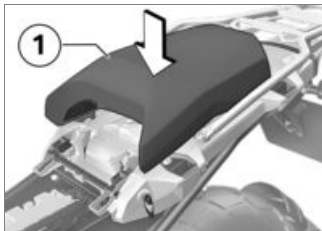

- Firmly press down rear seat **1**.  
» The rear seat engages with an audible click.
- Installing front seat (☞ 98).

## Remove front seat

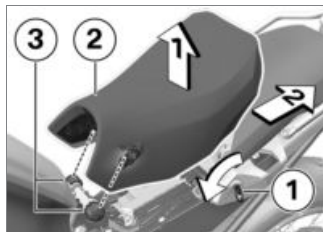

- Turn ignition key **1** counter-clockwise and hold it in this position, while slightly lifting front seat **2** at the rear.
- Work front seat **2** to the rear to disengage it from seat holder **3** and remove.
- Place the front seat, upholstered side down, on a clean surface.

## Adjusting the seat height and seat angle

- Remove front seat (☞ 97).

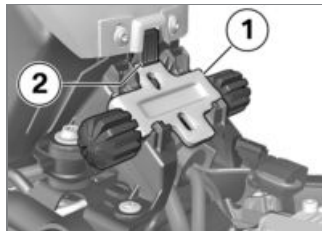

- To remove the front height adjustment **1**, push the locking mechanism **2** forwards and remove the height adjustment in an upwards direction.

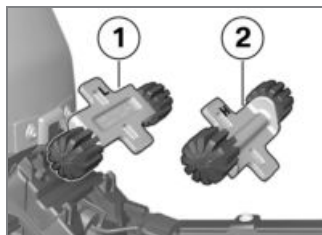

- To adjust the low seat position, install the front height adjust-

ment and align it with **1** (identification L).

- To adjust the high seat position, install the front height adjustment and align it with **2** (identification H).

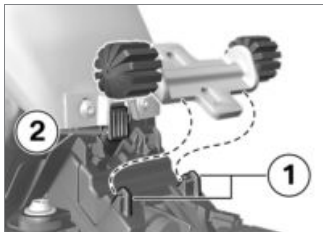

- First push the front height adjustment under the mounting **1** then push it into the locking mechanism **2** until it engages.

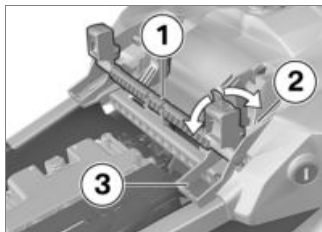

- To adjust the low seat position, swing the rear height adjustment **1** into position **3** (identification L).
- To adjust the high seat position, swing the rear height adjustment **1** into position **2** (identification H).

If the seat angle needs to be adjusted:

- Position the front and rear height adjustment differently.
- Installing front seat (▣ 98).

## Installing front seat

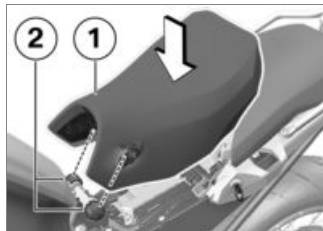

- Engage front seat **1** in seat mounts **2** on left and right and rest it on the motorcycle.
- Applying pressure to the rear of the seat, push the front seat slightly forward and then press the seat firmly down until the latch engages.

## Stowage compartment

### Opening and locking storage compartment

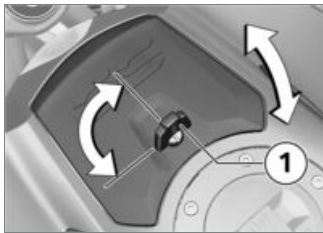

- To open the storage compartment **1**, turn the bow-shaped handle by 90° counter-clockwise and pull upwards.
- To lock the storage compartment **1**, close the storage compartment, turn the bow-shaped handle by 90° clockwise and fold it in the direction of travel onto the storage compartment.



## **TFT display**

General instructions.....	102
Principle .....	103
Pure Ride view.....	109
General settings .....	111
Bluetooth .....	112
My vehicle .....	115
Navigation .....	118
Media.....	120
Phone .....	120
Display software version .....	121
Display licence information.....	121

## General instructions

### Warnings



#### WARNING

#### Using a smartphone during the journey or while the engine is running

Risk of accident

- Always observe the relevant road traffic regulations.
- Do not use the smartphone during the journey (apart from applications that do not require operation, e.g. making telephone calls with the hands-free system).◀



#### WARNING

#### Distraction from the road and loss of control

Operating the integrated information system and communication devices while driving results in a risk of accident

- Operate those systems or devices only when the traffic situation allows for it.
- If necessary, stop and operate the systems or devices when stationary.◀

### Connectivity functions

Connectivity functions include media, telephony and navigation. Connectivity functions can be used if the TFT display is connected to a mobile end device and a helmet (📞▶ 112). For more information on the Connectivity functions go to **[bmw-motorrad.com/connectivity](http://bmw-motorrad.com/connectivity)**



#### NOTICE

If the fuel tank is between the mobile device and the TFT display, the Bluetooth connection may be restricted. BMW Motorrad recommends

storing the device above the fuel tank (e.g. in your jacket pocket).◀



#### NOTICE

Depending on the mobile device, the scope of the Connectivity functions may be restricted.◀

### BMW Motorrad Connected App

The BMW Motorrad Connected App contains usage and vehicle information. For some functions, such as navigation, the app must be installed on the mobile end device and connected to the TFT display. The app is used to start route guidance and adjust the navigation.



#### NOTICE

On some mobile devices, e.g. those with iOS operating systems, the BMW Motorrad Con-



nected App must be opened before use. ◀

## Actuality

The TFT display may be updated after the publication date. Because of this, your motorcycle may differ from the information supplied in the Rider's Manual. For up-to-date information go to [bmw-motorrad.com](http://bmw-motorrad.com)

## Principle Controls

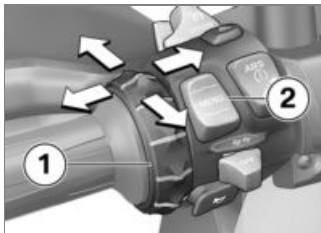

All contents of the display are operated using the multi-controller **1** and the MENU **2** rocker button.

Depending on the context, the following functions are possible.

### Multi-controller functions

#### Turn the multi-controller upwards:

- Move the cursor upwards in lists.
- Adjust settings.
- Increase volume.

#### Turn the multi-controller downwards:

- Move the cursor downwards in lists.
- Adjust settings.
- Decrease volume.

#### Tilt the multi-controller to the left:

- Activate the function in accordance with the operation feedback.
- Activate the function to the left or back.
- Go back to the View menu after settings.
- In the View menu, change up a level.
- In the My Vehicle menu: advance one menu screen.

#### Tilt the multi-controller to the right:

- Activate the function in accordance with the operation feedback.

- Confirm selection.
- Confirm settings.
- Advance a menu step.
- Scroll to the right in lists.
- In the My Vehicle menu: advance one menu screen.

### MENU rocker button functions

#### NOTICE

Instructions given by the navigation system are displayed in a dialogue box if the **Navigation** menu has not been called up. Operation of the MENU rocker button is temporarily restricted. ◀

#### Briefly push MENU up:

- In the View menu, change up a level.
- In the Pure Ride view: change the display for rider info status line.

#### Press and hold MENU up:

- In the View menu: call up Pure Ride view.
- In Pure Ride view: change operating focus to the Navigator.

#### Briefly push MENU down:

- Change down a level.
- No function if the lowest hierarchical level has been reached.

#### Hold MENU down:

- Change back to the last menu after a previous menu change by holding up the MENU rocker button.

### Operating instructions in the main menu

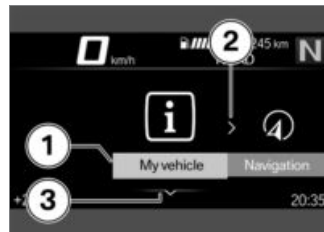

Operating instructions show whether interactions are possible, and which ones.

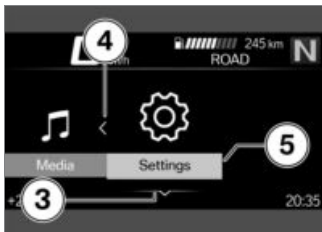

### What the operating instructions mean:

- Operating instruction **1**: the left end has been reached.
- Operating instruction **2**: it is possible to scroll to the right.
- Operating instruction **3**: it is possible to scroll down.
- Operating instruction **4**: it is possible to scroll to the left.
- Operating instruction **5**: the right end has been reached.

### Operating instructions in submenus

In addition to the operating instructions in the main menu, there are additional operating instructions in the submenus.

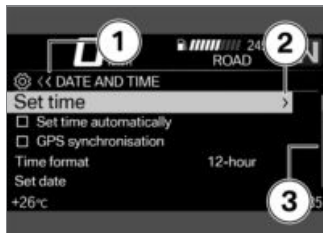

### Meaning of the operating instructions:

- Operating instruction **1**: The current display is located in a hierarchical menu. A submenu level is shown with a symbol. Two symbols indicate two or more submenu levels. The colour of the symbol changes de-

pending on whether you can return to a higher level.

- Operating instruction **2**: An additional submenu level can be called up.
- Operating instruction **3**: There are more entries than can be displayed.

### Display Pure Ride view

- Press and hold rocker button MENU up.

## Switching functions on and off



Some menu items have a check box in front of them. The check box shows whether the function is on or off. Action symbols after the menu items show what will be switched by tilting the multi-controller briefly to the right.

### Examples for switching on and off:

- Symbol **1** shows that the function is switched on.
- Symbol **2** shows that the function is switched off.

- Symbol **3** shows that the function can be switched off.
- Symbol **4** shows that the function can be switched on.

## Call up the menu

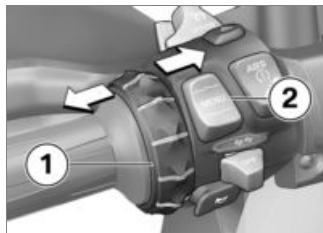

- Display Pure Ride view (105).
- Briefly push button **2** down.

The following menus can be called up:

- My vehicle
- Navigation
- Media
- Telephone
- Settings

- Repeatedly press the multi-controller **1** briefly to the right until the desired menu item is highlighted.
- Briefly push button **2** down.

## NOTICE

The Settings menu can only be called up when the vehicle is stationary. ◀

## Move the cursor in lists

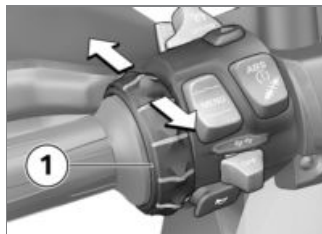

- Call up the menu (106).
- To move the cursor down in lists, turn the multi-controller **1**

down until the desired entry is highlighted.

- To move the cursor up in lists, turn the multi-controller **1** up until the desired entry is highlighted.

## Confirm selection



- Select the desired entry.
- Briefly press the multi-controller **1** to the right.

## Call up the last menu used

- In Pure Ride view: press and hold the MENU rocker button.

- » The last menu used is called up. The last entry highlighted is selected.

## Change of operating focus

- with preparation for navigation system<sup>OE</sup>

If the Navigator is connected, it is possible to switch between operation of the Navigator and the TFT display.

## Changing the operating focus

- with preparation for navigation system<sup>OE</sup>

- Secure the navigation device (► 209).
- Display Pure Ride view (► 105).
- Press and hold rocker button MENU up.
- » Operating focus switches to the Navigator or the TFT display. The active device is

marked on the left in the upper status line. Operator actions affect the currently active device until the operating focus is changed again.

- » Operating navigation system (► 211)

## System status displays

The system status is displayed in the lower area of the menu if a function is switched on or off.

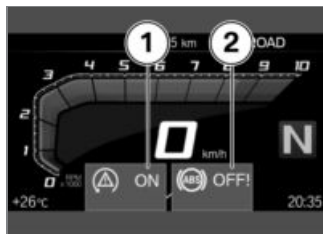

## Examples of what the system statuses mean:

- System status **1**: ASC/DTC function is switched on.

– System status **2**: ABS function is switched off.

## Switches the display for driver info. status line

### Requirement

The vehicle is at a standstill. The Pure Ride view appears on the display.

- Switching on ignition (➡ 62).
  - » All necessary information from the on-board computer for operation on public roads (e.g. TRIP **1**) and trip computer (e.g. TRIP **2**) are available in the TFT display. The information can be displayed in the top status line.
- with tyre pressure control (RDC)<sup>OE</sup>
  - » Information from the tyre pressure control can also be displayed.◀











- Select content of the rider info. status line (➡ 109).



- Press and hold the button **1** to display the Pure Ride view.
- Briefly press button **1** to select the value in the top status line **2**.

The following values can be displayed:

- Odometer *Total*
- Trip distance 1 TRIP 1
- Trip distance 2 TRIP 2
-  Average consumption 1

-  Average consumption 2
-  Riding time 1
-  Riding time 2
-  Break 1
-  Break 2
-  Average speed 1
-  Average speed 2
-  Tyre pressure
-  Fuel gauge.
-  Range

## Select content of the rider info. status line

- Call up the Settings, Display, Status line content menu.
- Switch on the desired displays.
  - » It is possible to switch between the selected displays in the rider info. status line. If no displays are selected, only the range will be displayed.

## Adjust settings



- Select and confirm the desired settings menu.

- Turn the multi-controller **1** downwards until the desired setting is highlighted.
- If there are operating instructions, tilt the multi-controller **1** to the right.
- If there are no operating instructions, tilt the multi-controller **1** to the left.
  - » The setting is saved.

## Switching Speed Limit Info on or off

### Requirement

Vehicle is connected with a compatible mobile end device. The BMW Motorrad Connected app is installed on the mobile end device.

- Speed Limit Info displays the maximum speed currently permitted.
- Call up the Settings, Display menu.

- Switch Speed Limit Info on or off.

## Pure Ride view

### Engine speed display

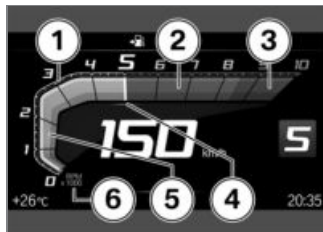

- 1** Scale
- 2** Lower engine speed range
- 3** Upper/red engine speed range
- 4** Needle
- 5** Secondary indicator
- 6** Engine speed display unit: 1000 revolutions per minute

**NOTICE**

The red engine speed range changes depending on the coolant temperature:

The colder the engine, the lower the speed at which the red engine speed range starts.

The warmer the engine, the higher the speed at which the red engine speed range starts.

When the operating temperature is reached, the display of the red engine speed range no longer changes.

The upshift recommendation is dynamically adapted. ◀

**Range**

The range readout **1** indicates how far you can ride with the fuel remaining in the tank. This distance is calculated on the basis of average consumption and the quantity of fuel on board.

- When the motorcycle is propped on its side stand the slight angle of inclination means that the sensor cannot register the fuel level correctly. This is the reason why the range is recalculated only when the side stand is in the retracted position.

- The range is shown together with a warning once the fuel reserve has been reached.
- After a refuelling stop, range is recalculated if the amount of fuel in the tank is greater than the reserve quantity.
- The calculated range is only an approximate figure.

**Recommendation to upshift**

The upshift recommendation **1** signals the economically best point in time for upshift.



## General settings

### Adjust the volume

- Connect rider's and passenger's helmet (▣ 114).
- Increase volume: turn the multi-controller upwards.
- Decrease volume: turn the multi-controller downwards.
- Mute: turn the multi-controller all the way down.

### Setting the date

- Switching on ignition (▣ 62).
- Call up the Settings, System settings, Date and time, Set date menu.
- Adjust Day, Month and Year.
- Confirm setting.

### Set date format

- Call up the Settings, System settings, Date and time, Date format menu.
- Select the desired setting.
- Confirm setting.

### Setting the clock

- Switching on ignition (▣ 62).
- Call up the Settings, System settings, Date and time, Set time menu.
- Adjust Hour and Minute.

### Setting time format

- Call up the Settings, System settings, Date and time, Time format menu.
- Select the desired setting.
- Confirm setting.

### Switching GPS synchronisation on or off

- with preparation for navigation system<sup>OE</sup>
- Call up the Settings, System settings, Date and time menu.
- Switch GPS synchronisation on or off.
  - » When the respective option is activated in the Navigator,

the time from the Navigator is applied.

» Special functions (▣ 213)

### Setting units of measurement

- Call up the Settings, System settings, Units menu.
- The following units of measurement can be set:
- Distance covered
  - Pressure
  - Temperature
  - Speed
  - Consumption

### Setting the language

- Call up the Settings, System settings, Language menu.
- The following languages can be adjusted:
- Chinese
  - German
  - English

- Spanish
- French
- Italian
- Dutch
- Portuguese
- Russian
- Ukrainian
- Polish
- Turkish

## Adjusting brightness

- Call up the `Settings`, `Display`, `Brightness` menu.
- Adjusting display brightness.

## Resetting all settings

- All the settings in the `Settings` menu can be reset to the factory settings.
- Call up the `Settings` menu.
- Select `Reset all` and confirm.

The settings in the following menus are reset:

- `Vehicle settings`
- `System settings`

- `Connections`
- `Display`
- `Information`

» Existing Bluetooth connections are not deleted.

## Bluetooth

### Short-range wireless technology

The Bluetooth function might not be available in certain countries.

Bluetooth is a short-range wireless technology. Bluetooth devices are short-range devices transmitting on the license-free ISM band (Industrial, Scientific, Medical) between 2.402 GHz and 2.480 GHz. They can be operated anywhere in the world without a licence being required. Although Bluetooth is designed to establish and sustain robust connections over short distances, as with every other wireless

technology disruptions are possible. Interference can affect connections or connections can sometimes fail. Particularly when multiple devices operate in a Bluetooth network, with wireless technology of this nature it is not possible to ensure fault-free communications in every situation.

### Possible sources of interference:

- interference zones due to transmission masts and similar.
- devices with non-compliant Bluetooth implementations.
- proximity of other Bluetooth-compatible devices.

### Pairing

Two Bluetooth devices must detect each other before they can create a connection with each other. This process of mutual recognition is known as pairing.



- » If the connection is not established, consult the troubleshooting chart in the section entitled "Technical data". (▣▣▣ 223)
- » Depending on the mobile end device, telephone data is transferred to the vehicle automatically.
- » Telephone data (▣▣▣ 121)
- » If the telephone book is not displayed, consult the troubleshooting chart in the section entitled "Technical data". (▣▣▣ 224)
- » If the Bluetooth connection is not working as expected, consult the troubleshooting chart in the section entitled "Technical data". (▣▣▣ 223)

### Connect rider's and passenger's helmet

- Pairing (▣▣▣ 113).

- Select Rider's helmet or Passenger helm. and confirm.
- Make the helmet's communication system visible.
- Select PAIRING NEW HELMETS OR PAIRING NEW PASS. HELM. and confirm.

Helmets are searched for.



The Bluetooth symbol flashes in the bottom status line during pairing.

Helmets found are displayed.

- Select and confirm helmet.
- » The connection is established and the connection status updated.
- » If the connection is not established, consult the troubleshooting chart in the section entitled "Technical data". (▣▣▣ 223)
- » If the Bluetooth connection is not working as expected, con-

sult the troubleshooting chart in the section entitled "Technical data". (▣▣▣ 223)

### Deleting connections

- Call up the Settings, Connections menu.
- Select Delete connections.
- To delete an individual connection, select the connection and confirm.
- To delete all connections, select Delete all connections and confirm.

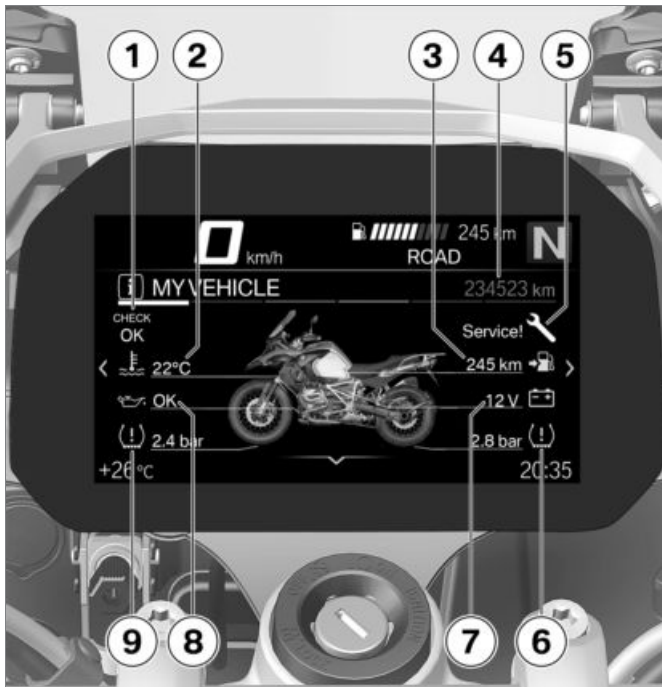

## My vehicle

### Start screen

- 1 Check Control display  
Mode of presentation (➡ 33)
- 2 Coolant temperature (➡ 47)
- 3 Range (➡ 110)
- 4 Total distance travelled
- 5 Service-due indicator (➡ 59)
- 6 Rear tyre pressure (➡ 49)
- 7 On-board voltage (➡ 194)
- 8 Engine oil level (➡ 47)
- 9 Front tyre pressure (➡ 49)

## Operating instructions

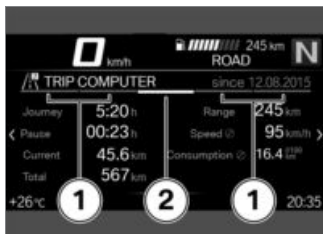

- Operating instruction **1**: tabs which show how far to the left or right can be scrolled.
- Operating instruction **2**: tab which shows the position of the current menu screen.

## Scrolling through menu screens

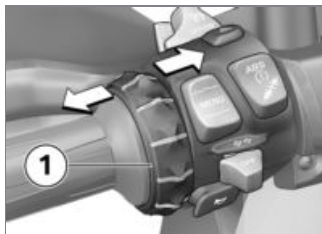

- Call up the *My vehicle* menu.
- To scroll to the right, briefly press Multi-Controller **1** to the right.
- To scroll to the left, briefly press Multi-Controller **1** to the left.

The *My Vehicle* menu contains the following screens:

- *MY VEHICLE*
- Check Control messages (if any)
- *ON-BOARD COMPUTER*
- *TRIP COMPUT.*

- with tyre pressure control (RDC)<sup>OE</sup>
- *TYRE PRESSURE*◀
- *SERVICE REQUIREMENTS*
- For more information on tyre pressure and Check Control messages, see the "Displays" section.

### NOTICE

Check control messages are attached dynamically to the *My Vehicle* menu screen as additional tabs.◀

## On-board computer and trip computer

The *ON-BOARD COMPUTER* and *TRIP COMPUT.* menu screens display vehicle and trip data, such as average values.

## Calling up the on-board computer

- Call up the *My vehicle* menu.

- Scroll to the right until the ON-BOARD COMPUTER menu screen is displayed.

## Resetting on-board computer

- Calling up the on-board computer (▣▣▣▣ 116).
- Press down the MENU rocker button.
- Select `Reset all values` or `Reset individual val.` and confirm.

The following values can be reset:

- Break
- Journey
- Current (TRIP 1)
- Av. spee.
- Av. consump.

## Calling up the trip computer

- Calling up the on-board computer (▣▣▣▣ 116).

- Scroll to the right until the TRIP COMPUT. menu screen is displayed.

## Resetting trip computer

- Calling up the trip computer (▣▣▣▣ 117).
- Press down the MENU rocker button.
- Select `Reset automatically` or `Reset all and confirm`.
- » If `Reset automatically` is selected, the on-board computer is automatically reset if a minimum of six hours have passed and the date has changed since the ignition was switched off.

## Service requirements

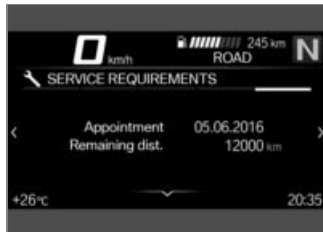

If the time remaining to the next service is less than a month or if the next service is due within 1000 km, a white CC message is displayed.

## Navigation Warnings



### Using a smartphone during the journey or while the engine is running

Risk of accident

- Always observe the relevant road traffic regulations.
- Do not use the smartphone during the journey (apart from applications that do not require operation, e.g. making telephone calls with the hands-free system).◀



### Distraction from the road and loss of control

Operating the integrated information system and communication devices while driving results in a risk of accident

- Operate those systems or devices only when the traffic situation allows for it.
- If necessary, stop and operate the systems or devices when stationary.◀

### Precondition

The vehicle is connected to a compatible mobile end device.

The BMW Motorrad Connected app is installed on the connected mobile end device.



On some mobile devices, e.g. those with iOS operating systems, the BMW Motorrad Connected App must be opened before use.◀

## Entering destination address

- Connect mobile end device (▣▣▣ 113).
- Call up the BMW Motorrad Connected App and start the route guidance.
- Call up the `Navigation` menu in the TFT display.
  - » Active route guidance is displayed.
  - » If the active route guidance is not displayed, consult the troubleshooting chart in the section entitled "Technical data". (▣▣▣ 224)

## Selecting destination from recent destinations

- Call up the `Navigation, Recent destinations` menu.
- Select and confirm destination.
- Select `Start route guidance`.



## Selecting destination from favourites

- The FAVOURITES menu displays all destinations which have been saved as favourites in the BMW Motorrad Connected app. No new favourites can be added using the TFT display.
- Call up the Navigation, Favourites menu.
- Select and confirm destination.
- Select Start guidance.

## Entering special destinations

- Special destinations, such as points of interest, can be displayed on the map.
- Call up the Navigation, POIs menu.

The following locations can be selected:

- At current location
- At destination

- Along the route
  - Select where the special destinations should be looked for. e.g. the following special destination can be selected:
    - Filling station
  - Select and confirm the special destination.
  - Select Start route guidance and confirm.

## Setting route criteria

- Call up the Navigation, Route criteria menu. The following criteria can be selected:
  - Route type
  - Avoid
    - Select desired Route type.
    - Switch desired Avoid on or off.

The number of avoidances activated is displayed in brackets.

## Ending route guidance

- Call up the Navigation, Active route guidance menu.
- Select End route guidance and confirm.

## Switching spoken instructions on or off

- Connect rider's and passenger's helmet (► 114).
- The navigation can be read out by a computer voice. For this purpose, Spoken instructions must be switched on.
- Call up the Navigation, Active route guidance menu.
- Switch Spoken instructions on or off.

## Repeating last spoken instruction

- Call up the Navigation, Active route guidance menu.

- Select **Current instruction** and confirm.

## Media

### Precondition

The vehicle is connected to a compatible mobile end device and helmet.

### Control music playback

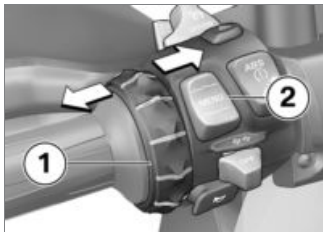

- Call up the **Media** menu.

#### NOTICE

BMW Motorrad recommends setting the volume on the mobile

end device for media and calls to maximum before setting off. ◀

- Adjust the volume (▶▶▶ 111).
- Next track: briefly tilt Multi-Controller **1** to the right.
- Last track or start of the current track: briefly tilt Multi-Controller **1** to the left.
- Fast forward: hold Multi-Controller **1** to the right.
- Rewind: hold Multi-Controller **1** to the left.
- Call up the context menu: press the bottom part of the button **2**.

#### NOTICE

Depending on the mobile device, the scope of the Connectivity functions may be restricted. ◀

- » The following functions can be used in the context menu:
  - Start playback or Pause playback.

- Select the **Now playing**, **All artists**, **All albums** or **All tracks** category for search and playback.
- Select **Playlists**.

You can adjust the following settings in the **Audio options** submenu:

- Switch **Shuffle** on or off.
- Select **Repeat**: **Off**, **One** (current track) or **All**.

## Phone

### Precondition

The vehicle is connected to a compatible mobile end device and helmet.

## Telephone calls

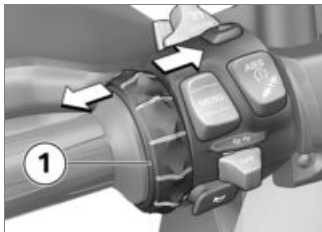

- Call up the **Telephone** menu.
- Accept call: tilt Multi-Controller **1** to the right.
- Reject call: tilt Multi-Controller **1** to the left.
- End the call: tilt Multi-Controller **1** to the left.

## Muting

During active phone calls, the microphone in the helmet can be muted.

## Phone calls with multiple participants

A second call can be accepted while you are on a call. The first phone call is put on hold. The number of active telephone calls is shown in the **Telephone** menu. It is possible to switch between two phone calls.

## Telephone data

Depending on the mobile end device, telephone data is transmitted to the vehicle automatically once pairing is complete (📶 112).

**Phone book:** list of contacts saved on the mobile end device

**Call list:** list of calls with the mobile end device

**Favourites:** list of favourites saved on the mobile end device

## Display software version

- Call up the **Settings, Information, Software version** menu.

## Display licence information

- Call up the **Settings, Information, Licences** menu.



## **Adjustment**

Mirrors .....	124
Headlight .....	125
Windscreen .....	126
Clutch .....	126
Brakes .....	127
Shift mechanism .....	130
Footrests .....	131
Handlebars .....	132
Spring preload .....	132
Damping .....	133

## Mirrors

### Adjusting mirrors



- Turn the mirror to the correct position.

### Adjusting mirror arm

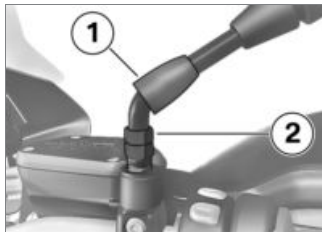

- Push protective cap **1** up over the threaded fastener on the mirror arm.
- Slacken nut **2**.
- Turn the mirror arm to the appropriate position.
- Tighten the nut to the specified tightening torque, while holding the mirror arm to ensure that it does not move out of position.



Mirror (locknut) to adapter

22 Nm (Left-hand thread)

- Push the protective cap over the threaded fastener.

### Adjusting mirrors

- with Option 719 Milled Part Set Classic<sup>OE</sup>
- or
- with Option 719 Milled Part Set Storm<sup>OE</sup>
- or
- with HP milled part package<sup>OE</sup>



### NOTICE

A small and a large angle screwdriver is supplied with the vehicle for adjusting the mirror arm. ◀

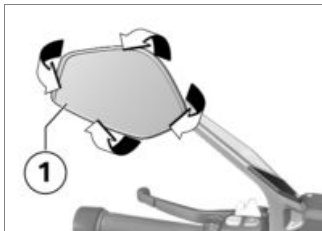

- Turn the mirror **1** to the correct position.

### Adjusting mirror arm

– with Option 719 Milled Part Set Classic<sup>OE</sup>

or

– with Option 719 Milled Part Set Storm<sup>OE</sup>

or

– with HP milled part package<sup>OE</sup>

#### NOTICE

A small and a large angle screwdriver is supplied with the vehicle for adjusting the mirror arm. ◀

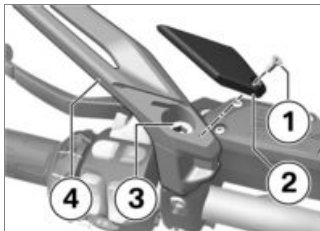

- Remove bolt **1** and cover **2**.
- Loosen adjusting screw **3** and turn the mirror arm **4** to the desired position.
- Tighten adjusting screw **3**, while holding the mirror arm.
- Attach cover **2** and fit bolt **1**.



Mirror on handlebars

25 Nm

## Headlight

### Headlight beam throw and spring preload

Headlight beam throw is generally kept constant when spring preload is adjusted to suit load. Spring preload adjustment might not suffice only if the motorcycle is very heavily loaded. Under these circumstances, headlight beam throw has to be adjusted to suit the weight carried by the motorcycle.



#### NOTICE

If there are doubts about the correct headlight beam throw, have the setting checked by a specialist workshop, preferably an authorised BMW Motorrad dealer. ◀

## Adjusting headlight beam throw

### Requirement

If, for a high load, the adjustment of the spring pre-load is no longer sufficient not to dazzle oncoming traffic:

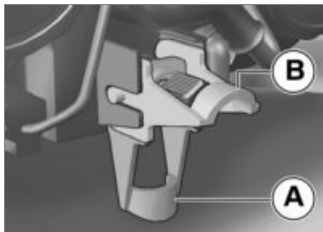

- The headlight beam-throw is adjusted via a bell crank.
- **A** neutral position
- **B** position if payload is high

## Windscreen

### Adjust windscreen



**WARNING**

### Adjusting the windscreen while riding

Risk of falling

- Do not attempt to adjust the windscreen unless the motorcycle is at a standstill. ◀

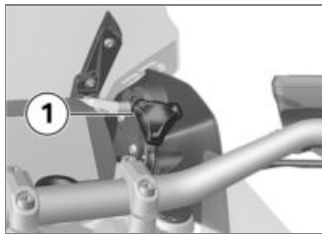

- Turn adjuster knob **1** clockwise to lower the windscreen.
- Turn adjuster knob **1** counter-clockwise to raise the windscreen.

## Clutch

### Adjust the clutch lever



**WARNING**

### Adjusting the clutch lever while riding

Risk of accident

- Adjust the clutch lever only when the motorcycle is at a standstill. ◀

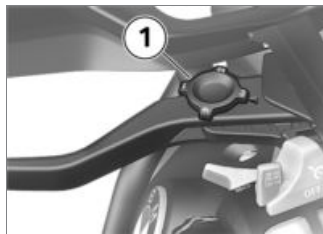

- Turn adjuster knob **1** to the desired position.



## NOTICE

The adjuster is easier to turn if you push the clutch lever forward.◀

- » Four settings are possible:
- Position 1: smallest distance between handlebar grip and clutch lever
- Position 4: largest distance between handlebar grip and clutch lever

- with Option 719 Milled Part Set Classic<sup>OE</sup>
- or
- with Option 719 Milled Part Set Storm<sup>OE</sup>
- or
- with HP milled part package<sup>OE</sup>

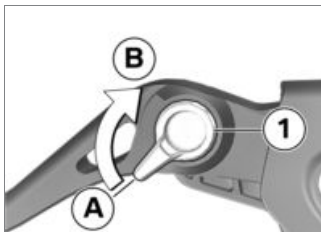

- Turn the adjustment lever **1** into the desired position.
- » Adjustment options:
- From position **A**: narrowest span between handlebar grip and clutch lever.
- In 5 steps in direction of position **B** for enlarging the dis-

tance between handlebar grip and clutch lever.◀

## Brakes

### Adjust the handbrake lever

#### WARNING

#### Adjusting the brake lever while riding

Risk of accident

- Do not attempt to adjust the brake lever unless the motorcycle is at a standstill.◀

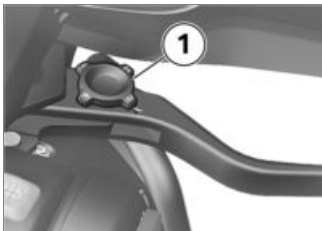

- Turn adjuster knob **1** to the desired position.

#### NOTICE

The adjuster is easier to turn if you push the brake lever forward. ◀

- » Four settings are possible:
  - Position 1: smallest distance between handlebar grip and brake lever
  - Position 4: largest distance between handlebar grip and brake lever

- with Option 719 Milled Part Set Classic<sup>OE</sup>
- or
- with Option 719 Milled Part Set Storm<sup>OE</sup>
- or
- with HP milled part package<sup>OE</sup>

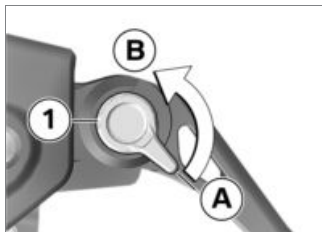

- Turn the adjustment lever **1** into the desired position.
  - » Adjustment options:
    - From position **A**: narrowest span between handlebar grip and handbrake lever.
    - In 5 steps in direction of position **B** for enlarging the dis-

tance between handlebar grip and handbrake lever. ◀

### Adjusting footbrake lever

- Make sure the ground is level and firm and place the motorcycle on its stand.

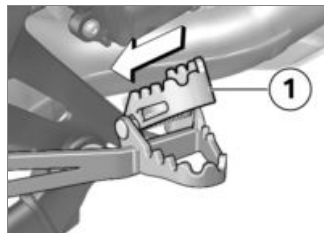

- Unlatch footplate **1** of the footrest by pushing it to the left.

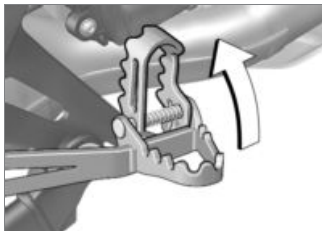

- Swing the footplate up until it latches in position for riding in the seated position.

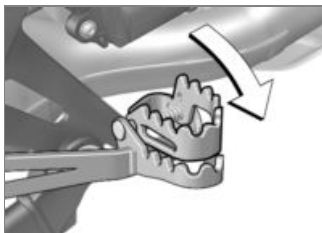

- Swing the footplate down until it latches in position for riding in the standing position.

## Adjust footbrake lever peg

- with Option 719 Milled Part Set Classic<sup>OE</sup>
- or
- with Option 719 Milled Part Set Storm<sup>OE</sup>
- or
- with HP milled part package<sup>OE</sup>

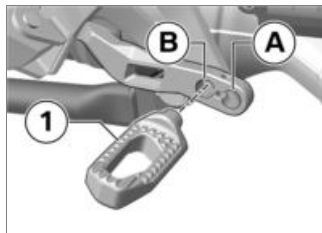

- Foot distance and height to peg **1** can be adjusted by turning through 180° and installation in position **A** or **B**.
- Remove the bolt **1**.

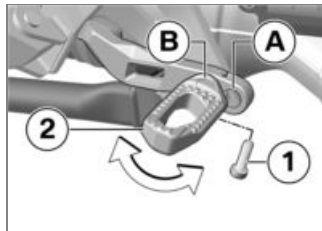

- Clean the threads.
- Install peg **2** in desired position **A** or **B**.
- Turn the peg **2** in the desired position.
- Fit **new** bolt **1**.



Peg to footbrake lever

Thread-locking compound:  
Micro-encapsulated

10 Nm

## Shift mechanism

### Adjusting shift lever

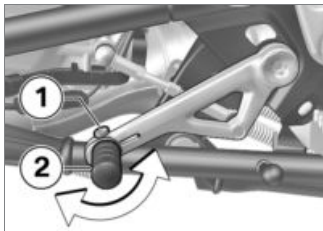

- Slacken screw **1**.
- Turn peg **2** to the desired position.

#### NOTICE

A peg that has been set too high or too low can lead to problems when shifting gear. Check the position of the peg if you experience shifting problems. ◀

- Tighten screw **1** to the specified tightening torque.



Peg (clamp) to shift lever

8 Nm

### Adjusting gearshift lever peg

- with Option 719 Milled Part Set Classic<sup>OE</sup>
- or
- with Option 719 Milled Part Set Storm<sup>OE</sup>
- or
- with HP milled part package<sup>OE</sup>

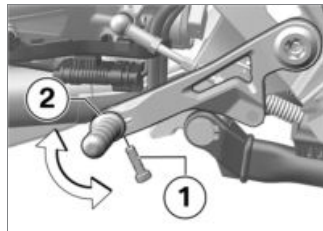

- Foot distance and height to peg **2** can be adjusted by turning to different positions.
- Remove the bolt **1**.

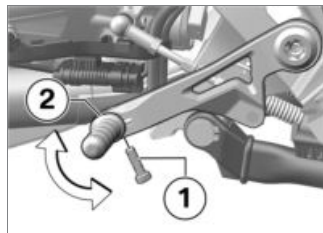

- Clean the threads.

- Turn the peg **2** in the desired position.
- Fit **new bolt 1**.

 Peg to gearshift lever

Thread-locking compound:  
Micro-encapsulated

10 Nm

## Footrests

- with Option 719 Milled Part Set Classic<sup>OE</sup>
- or
- with Option 719 Milled Part Set Storm<sup>OE</sup>
- or
- with HP milled part package<sup>OE</sup>

## Adjusting footrests

- The footrest is adjusted on the right and left in the same way.

- The position of the footrest must be set identically on the right and on the left.

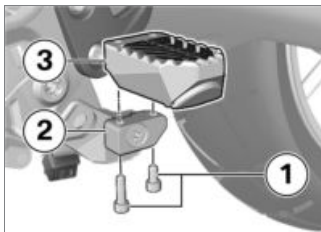

- Remove screws **1**.
- Remove footrest **3** from clamping block **2**.

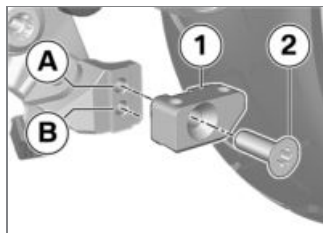

- Remove bolt **2**.
- Remove clamping block **1**.

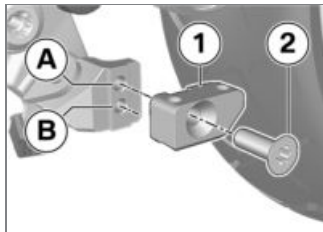

- Install clamping block **1** in required position **A** or **B** and tighten bolt **2**.



Clamping block on  
footrest hinge

20 Nm

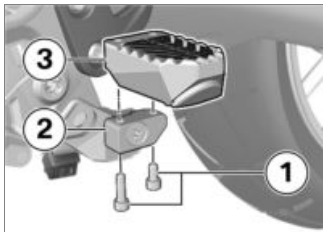

- Position footrest **3** on clamping block **2**.
- Install screws **1**.



Footrest on clamping  
block

10 Nm

- Remove and refit the footrest on the other side in the same way.

## Handlebars

### Adjustable handlebars

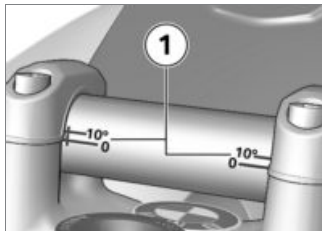

The inclination of the handlebars are adjustable in the ranges of mark **1**.

Have the handlebars adjusted by a specialist workshop, preferably an authorised BMW Motorrad Retailer.

### Spring preload

#### Adjustment

– without Dynamic ESA<sup>OE</sup>

It is essential to set the spring preload of the rear suspension to suit the load carried by the motorcycle. Increase the spring preload when the vehicle is heavily loaded and reduce the spring preload accordingly when the vehicle is lightly loaded.

### Adjusting spring preload for rear wheel

- Make sure the ground is level and firm and place the motorcycle on its stand.



**! WARNING**

**Spring preload setting and spring-strut damping setting not matched.**

Impaired handling.

- Adjust spring-strut damping to suit spring preload.◀

**! WARNING**

**Adjusting spring preload while riding.**

Risk of accident

- Do not attempt to adjust spring preload unless the motorcycle is at a standstill.◀
- If you want to increase spring preload, turn knob **1** in the direction indicated by the HIGH arrow.
- If you want to reduce spring preload, turn knob **1** in the direction indicated by the LOW arrow.



Basic setting of spring preload, rear

– without Dynamic ESA<sup>OE</sup>

Turn the knob as far as it will go in the LOW direction. (One-up without luggage)

Turn the adjuster knob as far as it will go in the LOW direction, then 15 turns in the HIGH direction. (One-up with luggage)



Basic setting of spring preload, rear

Turn the adjuster knob as far as it will go in the LOW direction, then 30 turns in the HIGH direction. (Two-up with luggage)◀

**Damping**

– without Dynamic ESA<sup>OE</sup>

**Setting**

Damping must be adapted to suit the surface on which the motorcycle is ridden and to suit spring preload.

- An uneven surface requires softer damping than a smooth surface.
- An increase in spring preload requires firmer damping, a reduction in spring preload requires softer damping.

## Adjust the damping for rear wheel

- Make sure the ground is level and firm and place the motorcycle on its stand.
- Work on the left-hand side of the vehicle when adjusting the damping.



- If you want to increase damping, turn adjusting screw **1** clockwise.
- If you want to reduce damping, turn adjusting screw **1** counter-clockwise.

 Basic setting of rear-suspension damping characteristic

Turn the adjuster knob as far as it will go in the clockwise direction, then back it off 8 clicks in the counter-clockwise direction. (One-up without luggage)

Turn the adjuster knob as far as it will go in the clockwise direction, then back it off 4 clicks in the counter-clockwise direction. (One-up with luggage)

Turn the adjuster knob as far as it will go in the clockwise direction, then back it off 4 clicks in the counter-clockwise direction. (Two-up with luggage)



## **Riding**

Safety information .....	136
Comply with checklist.....	138
Always before riding off: .....	139
At every third refuelling stop .....	139
Starting .....	139
Running in .....	142
Off-road use .....	143
Shifting gear .....	144
Brakes .....	145
Parking your motorcycle .....	147
Refuelling .....	148
Securing motorcycle for transportation .....	152

## Safety information

### Rider's equipment

Do not ride without the correct clothing! Always wear:

- Helmet
- Motorcycling jacket and trousers
- Gloves
- Boots

This applies even to short journeys, and to every season of the year. Your authorised BMW Motorrad dealer will be glad to advise you on the correct clothing for every purpose.

### Restricted angle of heel

A motorcycle with lowered suspension has less ground clearance and cannot corner at angles of heel as extreme as those achievable by a counterpart motorcycle with standard-height suspension.



### WARNING

**When a motorcycle with lowered suspension is cornering, certain components can come into contact with the surface at a bank angle less than that to which the rider is accustomed.**

Risk of falling

- Carefully try out the limits of the motorcycle's bank angle and adapt your style of riding accordingly.◀

Test your motorcycle's angle of heel in situations that do not involve risk. When riding over kerbs and similar obstacles, bear in mind that your motorcycle's ground clearance is limited.

Lowering the motorcycle's suspension shortens suspension travel (see the section entitled "Technical Data"). Ride comfort might be restricted as a result.

Be sure to adjust spring preload accordingly, particularly for riding two-up.

### Loading



### WARNING

**Handling adversely affected by overloading and imbalanced loads**

Risk of falling

- Do not exceed the permissible gross weight and be sure to comply with the instructions on loading.◀
- Adjusting spring preload setting and damping to the total weight.
- Ensure that the case volumes on the left and right are equal.
- Make sure that the weight is uniformly distributed between right and left.

- Pack heavy items at the bottom and toward the inboard side.
  - Note the maximum permissible payload and the speed limit for riding with cases fitted, as stated on the label inside the case (see also the section entitled "Accessories").
  - Note the maximum permissible payload and the speed limit for riding with topcase fitted, as stated on the label inside the case (see also the section entitled "Accessories").
- with tank bag<sup>OA</sup>
- Note the maximum permissible payload of the tank rucksack.



Payload of tank rucksack

max 5 kg◀

## Speed

If you ride at high speed, always bear in mind that various boundary conditions can adversely affect the handling of your motorcycle:

- Settings of the spring-strut and shock-absorber system
- Imbalanced load
- Loose clothing
- Insufficient tyre pressure
- Poor tyre tread
- Etc.

## Maximum speed with knobby tyres or winter tyres

**! DANGER**

**Maximum speed of the motorcycle is higher than the permissible maximum rated speed of the tyres**

Risk of accident due to tyre damage at high speed

- Comply with the tyre-specific speed restrictions.◀

Always bear the maximum permissible speed of the tyres in mind when riding a motorcycle fitted with knobby tyres or winter tyres.

Affix a label stating the maximum permissible speed to the instrument panel in the rider's field of vision.

## Risk of poisoning

Exhaust fumes contain carbon monoxide, which is colourless and odourless but highly toxic.

**! WARNING**

**Exhaust gases adversely affecting health**

Risk of asphyxiation

- Do not inhale exhaust fumes.
- Do not run the engine in an enclosed space.◀

## Risk of burn injury



### CAUTION

#### Engine and exhaust system become very hot when the vehicle is in use

Risk of burn injury

- When you park the vehicle make sure that no-one and no objects can come into contact with the hot engine and exhaust system.◀

## Catalytic converter

If misfiring causes unburned fuel to enter the catalytic converter, there is a danger of overheating and damage.

The following guidelines must be observed:

- Do not run the fuel tank dry.
- Do not attempt to start or run the engine with a spark-plug cap disconnected.

- Stop the engine immediately if it misfires.
- Use only unleaded fuel.
- Comply with all specified maintenance intervals.



### ATTENTION

#### Unburned fuel in catalytic converter

Damage to catalytic converter

- Note the points listed for protection of the catalytic converter.◀

## Risk of overheating



### ATTENTION

#### Engine running for prolonged period with vehicle at standstill

Overheating due to insufficient cooling; in extreme cases vehicle fire

- Do not allow the engine to idle unnecessarily.
- Ride away immediately after starting the engine.◀

## Tampering



### ATTENTION

#### Tampering with the motorcycle (e.g. engine management ECU, throttle valves, clutch)

Damage to the affected parts, failure of safety-relevant functions, voiding of warranty

- Do not tamper with the vehicle in any way that could result in tuned performance.◀

## Comply with checklist

- At regular intervals, use the checklist below to check your motorcycle.

## Always before riding off:

- Check operation of the brake system.
- Check operation of the lights and signalling equipment.
- Checking clutch function (➡ 180).
- Checking tyre tread depth (➡ 182).
- Checking tyre pressure (➡ 181).
- Check that cases and luggage are securely held in place.

## At every third refuelling stop

- Checking engine oil level (➡ 174).
- Checking front brake pad thickness (➡ 176).
- Check the rear brake pad thickness (➡ 177).

- Checking brake-fluid level, front brakes (➡ 178).
- Checking the brake-fluid level, rear brakes (➡ 179).
- Check coolant level (➡ 180).

## Starting

### Starting the engine

- Switch on the ignition.
  - » Pre-Ride-Check is performed. (➡ 140)
  - » ABS self-diagnosis is in progress. (➡ 140)
    - without riding modes Pro<sup>OE</sup>
    - » ASC self-diagnosis is performed. (➡ 141)◀
  - with riding modes Pro<sup>OE</sup>
    - » DTC self-diagnosis is in progress. (➡ 141)◀
- Select neutral or, if a gear is engaged, pull the clutch lever.



### NOTICE

You cannot start the motorcycle with the side stand extended and

a gear engaged. The engine will switch itself off if you start it with the gearbox in neutral and then engage a gear before retracting the side stand.◀

- For a cold engine start and low temperatures: pull clutch.



- Press the starter button 1.



### NOTICE

The start attempt is automatically interrupted if battery voltage is too low. Recharge the battery before you start the engine, or

use jump leads and a donor battery to start.

See the subsection on jump starting in "Maintenance" for more details. ◀

- » The engine starts.
- » If the engine refuses to start, consult the troubleshooting chart in the section entitled "Technical data". (▶▶▶ 222)

## Pre-Ride-Check

When the ignition is switched on, the instrument cluster runs a test of the indicator and warning lights. This test is known as the "Pre-Ride-Check". The test is aborted if you start the engine before it completes.

### Phase 1

All indicator and warning lights are switched on.

After a longer vehicle standstill period, an animation is displayed when the system starts up.

### Phase 2

The 'General' warning light changes from red to yellow.

### Phase 3

All the indicator and warning lights switched on in the initial phase are switched off in reverse sequence.

The malfunction indicator lamp only goes out after 15 seconds.

If one of the indicator and warning lights did not switch on:

- Have the fault rectified as quickly as possible by a specialist workshop, preferably an authorised BMW Motorrad Retailer.

## ABS self-diagnosis

BMW Motorrad Integral ABS performs self-diagnosis to ensure its operability. Self-diagnosis is performed automatically when you switch on the ignition. Ride the vehicle a few metres at speeds over 5 km/h to check the wheel speed sensors.

### Phase 1

- » Test of the diagnosable system components with the vehicle at a standstill.



ABS telltale and warning light flashes.

### Phase 2

- » Test of the wheel-speed sensors as the vehicle pulls away from rest.



ABS telltale and warning light flashes.

## ABS self-diagnosis completed

» The ABS indicator and warning light goes out.

- Check all the indicator and warning lights.

After the ABS self-diagnosis completes, an indicator showing an ABS fault will appear.

- You can continue to ride. Bear in mind that neither the ABS function nor the integral braking function is available.
- Have the fault rectified as quickly as possible by a specialist workshop, preferably an authorised BMW Motorrad dealer.

## ASC self-diagnosis

– without riding modes Pro<sup>OE</sup>

BMW Motorrad ASC performs self-diagnosis to ensure its operability. Self-diagnosis is per-

formed automatically when you switch on the ignition.

### Phase 1

» Test of the diagnosable system components with the vehicle at a standstill.



ASC indicator and warning light flashing slowly.

### Phase 2

» Test of the diagnosis-capable system components while the motorcycle is on the move (speed at least 5 km/h).



ASC indicator and warning light flashing slowly.

## ASC self-diagnosis completed

» The ASC telltale and warning light goes out.

- Check all the indicator and warning lights.

After completion of ASC self-diagnosis, an indicator showing an ASC fault is displayed:

- You can continue to ride. Bear in mind that the ASC function is not available.
- Have the fault rectified as quickly as possible by a specialist workshop, preferably an authorised BMW Motorrad dealer.

## DTC self-diagnosis

– with riding modes Pro<sup>OE</sup>

BMW Motorrad DTC performs self-diagnosis to ensure its operability. Self-diagnosis is performed automatically when you switch on the ignition.

### Phase 1

» Test of the diagnosis-compatible system components with the vehicle at a standstill.

 DTC indicator and warning light flashes slowly.

### Phase 2

» Pullaway test of the system components with diagnostic capability.

 DTC indicator and warning light flashes slowly.

### DTC self-diagnosis completed

» The DTC symbol no longer shows.

- Check all the indicator and warning lights.



DTC self-diagnosis not completed

The DTC function is not available, because self-diagnosis did not complete. (The motorcycle has to reach a defined minimum speed with the engine running for the wheel-speed sensors to be checked: min 5 km/h)

If an indicator showing an DTC fault appears when DTC self-diagnosis completes:

- You can continue to ride. Bear in mind that the DTC function is not available or the functionality might be subject to certain restrictions.
- Have the fault rectified as quickly as possible by a specialist workshop, preferably an authorised BMW Motorrad dealer.

## Running in Engine

- Until the first running-in check, vary the throttle opening and engine-speed range frequently; avoid riding at constant engine rpm for prolonged periods.
- Try to do most of your riding during this initial period on twisting, fairly hilly roads.
- Comply with the rpm limits for running in.



Running-in speeds

<5000 min<sup>-1</sup> (Odometer reading 0...1000 km)

No full load (Odometer reading 0...1000 km)

- Note the mileage after which the running-in check should be carried out.





Mileage until the running-in check

500...1200 km

## Brake pads

New brake pads have to bed down before they can achieve their optimum friction levels. You can compensate for this initial reduction in braking efficiency by exerting greater pressure on the levers.

### WARNING

#### New brake pads

Longer stopping distance, risk of accident

- Apply the brakes in good time.◀

## Tyres

New tyres have a smooth surface. This must be roughened by riding in a restrained manner at various heel angles until the tyres are run in. This running in procedure is essential if the tyres are to achieve maximum grip.

### WARNING

#### New tyres losing grip on wet roads and at extreme bank angles

Risk of accident

- Ride carefully and avoid extremely sharp inclines.◀

## Off-road use

### After off-roading

BMW Motorrad recommends checking the following after riding the motorcycle off-road:

## Tyre pressure

### WARNING

#### Lower tyre pressure for off-roading in operation on smooth roads

Risk of accident due to impaired driving characteristics.

- Always check that the tyre pressures are correct.◀

## Brakes

### WARNING

#### Driving on unpaved or dirt roads

Delayed braking efficiency due to soiled brake disks and brake pads.

- Brake early until the brakes are clean.◀

**ATTENTION****Riding on unsurfaced or dirty roads**

Increased brake pad wear

- Check the thickness of the brake pads more frequently and replace the brake pads in good time. ◀

**Spring preload and shock-absorber settings****WARNING****Changed values for spring preload and spring strut damping for off-roading**

Impaired driving characteristics on paved roads

- Before leaving the off-road terrain, set the correct spring preload and shock absorption. ◀

**Rims**

BMW Motorrad recommends checking the rims for damage after off-roading.

**Air filter element****ATTENTION****Dirty air filter element**

Engine damage

- If you ride in dusty terrain check the air filter element for clogging at shorter intervals; clean or replace as necessary. ◀

Operation in very dusty conditions (desert, steppes, or the like) necessitates the use of air filter elements specially designed for conditions of this nature.

**Shifting gear**

– with shift assistant Pro<sup>OE</sup>

**Shift assistant Pro Requirement**

The shift assistant assists upshifts and downshifts without the rider having to pull the clutch or close the throttle. This is not an automatic-shift system. The rider is the most important part of the system and decides when to shift gears.

**NOTICE**

See the section entitled "Engineering details" for more information on the Pro shift assistant. ◀

**NOTICE**

Whenever the Pro shift assistant shifts down, cruise control is automatically disengaged for safety reasons. ◀

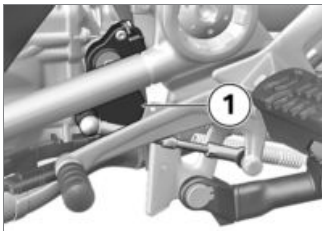

- You select the gear in the usual way by means of the foot-operated shift lever.
- » The sensor **1** on the gearshift shaft registers the gearshift request and triggers shift assistance.
- » When riding at a steady speed in a low gear at high engine rpm, an attempt to shift gear without pulling the clutch can cause a severe load-change reaction. BMW Motorrad recommends disengaging the clutch for shifts in these circumstances. It is advisable to avoid using the Pro Gear Shift

Assistant at engine speeds close to the limits at which the governor cuts in to limit engine rpm.

- » Shift assistance is not available in the following situations:
  - With clutch lever pulled.
  - Shift lever not in its initial position.
  - Upshifts with the throttle valve closed (coasting overrun) and when decelerating.
  - When shifting down with the throttle valve open or when accelerating.
- After a gear change, the shift lever has to be fully released before another gearshift with the Pro Gear Shift Assistant can take place.

## Brakes

### How can stopping distance be minimised?

Each time the brakes are applied, a load distribution shift takes place with the load shifting forward from the rear to the front wheel. The sharper the motorcycle decelerates, the more load is shifted to the front wheel. The higher the wheel load, the more braking force can be transmitted without the wheel locking.

To optimise stopping distance, apply the front brakes rapidly and keep on increasing the force you apply to the brake lever. This makes the best possible use of the dynamic increase in load at the front wheel. Remember to pull the clutch at the same time. In the "panic braking situations" that are trained so frequently braking force is applied as rapidly as possible and with the

rider's full force applied to the brake levers; under these circumstances the dynamic shift in load distribution cannot keep pace with the increase in deceleration and the tyres cannot transmit the full braking force to the surface of the road.

BMW Motorrad Integral ABS prevents the front wheel from locking up.

### Panic braking

If the vehicle decelerates sharply above 50 km/h, the brake light will flash rapidly to warn road users behind the vehicle.

If the vehicle decelerates to below 15 km/h, the hazard warning lights come on. When the speed increases to above 20 km/h, the hazard warning lights are switched off again automatically.

## Descending mountain passes



### Braking only with the rear brake on mountain descents

Brake fade, destruction of the brakes due to overheating

- Use both front and rear brakes, and make use of the engine's braking effect as well. ◀

### Wet and dirty brakes

Wetness and dirt on the brake discs and the brake pads diminish braking efficiency.

Delayed braking action or poor braking efficiency must be reckoned with in the following situations:

- Riding in the rain or through puddles of water.
- After the vehicle has been washed.

- Riding on salted or gritted roads.
- After work has been carried on the brakes, due to traces of oil or grease.
- Riding on dirt-covered surfaces or off-road.



### Wetness and dirt result in diminished braking efficiency

Risk of accident

- Apply the brakes lightly while riding to remove wetness and dirt, or dismount and clean the brakes.
- Think ahead and brake in good time until full braking efficiency is restored. ◀

### ABS Pro

- with ABS Pro<sup>OE</sup>

## Physical limits applicable to motorcycling

### **WARNING**

#### **Braking when cornering**

Risk of crash despite ABS Pro

- Invariably, it remains the rider's responsibility to adapt riding style to riding conditions.
- Do not take risks that would negate the additional safety offered by this system.◀

ABS Pro and the assisting function of the Dynamic Brake Control are available in all riding modes except Enduro PRO.

#### **Possibility of a fall not precluded**

Although ABS Pro and Dynamic Brake Control provide the rider with valuable assistance and constitute a huge advance in safety for braking with

the motorcycle banked for cornering, they cannot under any circumstances be considered as redefining the physical limits that apply to motorcycling. It is still possible for these limits to be overshoot due to misjudgement or rider error. In extreme cases this can result in a crash.

#### **Use on public roads**

ABS Pro and Dynamic Brake Control help make the motorcycle even safer for riding on public roads. When the brakes are applied because of an unforeseen hazard when the motorcycle is banked for cornering, within the physical limits that apply to motorcycling the system prevents the wheels from locking and skidding away. During emergency braking, Dynamic Brake Control increases the braking effect and intervenes when the throttle grip

is accidentally actuated during the braking process.

### **NOTICE**

ABS Pro was not developed to enhance individual braking performance with the motorcycle banked into corners.◀

## **Parking your motorcycle**

### **Side stand**

- Switch off the engine.

### **ATTENTION**

#### **Poor ground underneath the stand**

Risk of damage to parts if vehicle topples

- Always check that the ground under the stand is level and firm.◀

 **ATTENTION**

### Additional weight placing strain on the side stand

Risk of damage to parts if vehicle topples

- Do not sit or lean on the vehicle while it is propped on the side stand. ◀
- Extend the side stand and prop the motorcycle on the stand.
- Turn the handlebars all the way to left.
- On a gradient, the motorcycle should always face uphill; select 1st gear.

### Centre stand

- Switch off the engine.

 **ATTENTION**

### Poor ground underneath the stand

Risk of damage to parts if vehicle topples

- Always check that the ground under the stand is level and firm. ◀

 **ATTENTION**

### Centre stand folds in due to sharp movements

Risk of damage to parts if vehicle topples

- Do not lean or sit on the vehicle with the centre stand extended. ◀
- Extend the centre stand and lift the motorcycle onto the stand.
- On a gradient, the motorcycle should always face uphill; select 1st gear.

## Refuelling

### Fuel grade

#### Requirement

To ensure optimal fuel consumption, fuel should be sulphur-free or as low-sulphur as possible.

 **ATTENTION**

### Engine operation with leaded fuel

Damage to catalytic converter

- Do not attempt to run the vehicle on leaded fuel or fuel with metallic additives (e.g. manganese or iron). ◀
- Observe the maximum ethanol content of the fuel.



Recommended fuel grade



Super unleaded (maximum 15% ethanol, E15)



95 ROZ/RON  
90 AKI



Alternative fuel grade

**E5**

Normal unleaded  
(with power loss)

**E10**

(maximum 15 % ethanol,  
E15)  
91 ROZ/RON  
87 AKI

» Pay attention to the following symbols in the fuel filler cap and on the fuel pump:

**E5**

**E10**

» After refuelling with fuels of poor-quality, sporadic knocking noises may be perceptible.

## Refuelling



**WARNING**

**Fuel is highly flammable**

Risk of fire and explosion

- Do not smoke. Never bring a naked flame near the fuel tank.◀



**WARNING**

**Escape of fuel due to heat-induced expansion if fuel tank is overfilled**

Risk of falling

- Do not overfill the fuel tank.◀



**ATTENTION**

**Wetting of plastic surfaces by fuel**

Damage to the surfaces (surfaces become unsightly or dull)

- Clean plastic surfaces immediately after contact with fuel.◀
- Make sure the ground is level and firm and place the motorcycle on its centre stand.

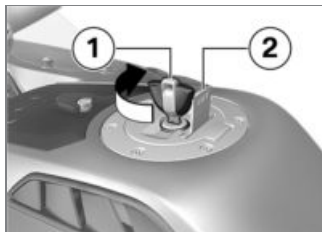

- Open the protective cap **2**.
- Unlock the fuel tank cap by turning the ignition key **1** clockwise and open up.



- Refuel with fuel up to the lower edge of the filler neck.

 **NOTICE**

When refuelling after running on reserve, make sure that you top up the tank to a level above reserve, so that the new level is detected and the fuel reserve indicator light is switched off. ◀

 **NOTICE**

The "usable fuel capacity" specified in the technical data is the quantity that the fuel tank could hold if refilled after it had been run dry and the engine had cut out due to a lack of fuel. ◀



Usable fuel capacity

approx. 30 l



Reserve fuel

approx. 4 l

- Press the fuel tank cap down firmly to close.
- Remove the key and close the protective cap.

## Refuelling

– with Keyless Ride<sup>OE</sup>

### Requirement

The steering lock is disengaged.



## WARNING

### Fuel is highly flammable

Risk of fire and explosion

- Do not smoke. Never bring a naked flame near the fuel tank. ◀



## WARNING

### Escape of fuel due to heat-induced expansion if fuel tank is overfilled

Risk of falling

- Do not overfill the fuel tank. ◀



## ATTENTION

### Wetting of plastic surfaces by fuel

Damage to the surfaces (surfaces become unsightly or dull)

- Clean plastic surfaces immediately after contact with fuel. ◀
- Make sure the ground is level and firm and place the motorcycle on its centre stand.
  - with Keyless Ride<sup>OE</sup>
  - Switching off ignition (➡ 65).



## NOTICE

The fuel filler cap can be opened within the defined waiting time after the ignition has been switched off, without the radio-operated key being within range. ◀





Waiting time for opening  
fuel filler cap

2 min

- » There are **two variant ways** of opening the fuel filler cap:
  - Within the waiting time.
  - After the waiting time has expired.

### Version 1

– with Keyless Ride<sup>OE</sup>

### Requirement

Within the waiting time



- Slowly pull tab **1** on the fuel filler cap up.
  - » Fuel filler cap unlocks.
- Fully open the fuel filler cap.

### Version 2

– with Keyless Ride<sup>OE</sup>

### Requirement

After the waiting time has expired

- Bring the radio-operated key into range.
- Slowly pull tab **1** up.
  - » The telltale light for the radio-operated key flashes while the

search for the radio-operated key is in progress.

- Again slowly pull up tab **1** of the fuel filler cap.
  - » Fuel filler cap unlocks.
- Fully open the fuel filler cap.



- Refuel with fuel of the grade stated above; do not fill the tank past the bottom edge of the filler neck.



### NOTICE

When refuelling after running on reserve, make sure that you top up the tank to a level above reserve, so that the new level is

detected and the fuel reserve indicator light is switched off.◀



## NOTICE

The "usable fuel capacity" specified in the technical data is the quantity that the fuel tank could hold if refilled after it had been run dry and the engine had cut out due to a lack of fuel.◀



Usable fuel capacity

approx. 30 l



Reserve fuel

approx. 4 l

- Press down firmly on the filler cap of the fuel tank.
- » The fuel filler cap engages with an audible click.

- » The fuel filler cap locks automatically when the waiting time expires.
- » The engaged fuel filler cap locks immediately when you secure the steering lock or switch on the ignition.

## Securing motorcycle for transportation

- Make sure that all components that might come into contact with straps used to secure the motorcycle are adequately protected against scratching. Use adhesive tape or soft cloths, for example, for this purpose.



## ATTENTION

### Vehicle topples to side when being lifted on to stand

Risk of damage to parts if vehicle topples

- Secure the vehicle to prevent it toppling, preferably with the assistance of a second person.◀
- Push the motorcycle onto the transportation flat and hold it in position: do not place it on the side stand or centre stand.

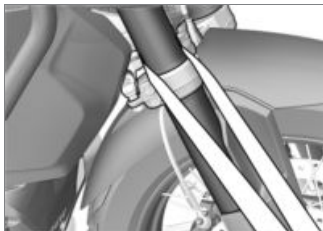

## ATTENTION

### Trapping of components

Component damage

- Do not trap components such as brake lines or cable legs. ◀
- Pass the tensioning straps on left and right through the fork bridge and strap the motorcycle down.



- Secure the tensioning straps behind on both sides on the bracket for the rear footrest and tighten.
- Tension all tensioning straps evenly so that the motorcycle is securely fastened.



## Engineering details

General instructions.....	156
Antilock Brake System (ABS) .....	156
Traction control (ASC/DTC).....	159
Dynamic ESA.....	161
Riding mode .....	162
Dynamic Brake Control .....	164
Tyre pressure control (RDC) .....	165
Shift assistant.....	167
Hill Start Control .....	168
ShiftCam .....	170

## General instructions

To find out more about engineering, go to:

**[bmw-motorrad.com/technology](http://bmw-motorrad.com/technology)**

## Antilock Brake System (ABS)

### Partially integral brakes

Your motorcycle is equipped with partially integral brakes. Both front and rear brakes are applied when you pull the handbrake lever. The footbrake lever acts only on the rear brake.

While the brakes are slowing the motorcycle with ABS actively intervening, the BMW Motorrad Integral ABS adapts braking-force distribution between front and rear brakes to suit the load on the motorcycle.



## ATTENTION

### Attempted burn-out despite Integral braking function

Damage to rear brake and clutch

- Do not burn out tyres. ◀

### How does ABS work?

The amount of braking force that can be transferred to the road depends on factors that include the coefficient of friction of the road surface. Loose stones, ice and snow or a wet road all have much lower coefficients of friction than a clean and dry asphalt surface. The lower the coefficient of friction, the longer the braking distance.

If the rider increases braking pressure to the extent that braking force exceeds the maximum transferable limit, the wheels start to lock and the vehicle loses its directional stability; a fall is imminent. Before this situation oc-

curs the ABS will be activated and the brake pressure adapted to the maximally transferable braking force. The wheels continue to turn and the driving stability is retained irrespective of the road condition.

### What are the effects of surface irregularities?

Humps and surface irregularities can cause the wheels to lose contact temporarily with the road surface; if this happens the braking force that can be transmitted to the road can drop to zero. If the rider brakes in this situation, the ABS has to reduce the brake pressure in order to ensure driving stability when resuming contact with the road. Up to this point, BMW Motorrad Integral ABS assumes an extremely low coefficient of friction (gravel, ice, snow) so that the road wheels turn in every conceivable situ-

ation and so ensure driving stability. As soon as it registers the actual circumstances, the system reacts instantly and adjusts braking force accordingly to achieve optimum braking.

### **What feedback does the rider receive from the BMW Motorrad Integral ABS?**

If the ABS system has to reduce braking force on account of the circumstances described above, vibration is perceptible through the handbrake lever.

When the handbrake lever is pulled, brake pressure is also built up at the rear wheel by the integral function. If the brake pedal is depressed after the handbrake lever is pulled, the brake pressure built up beforehand is perceptible as counter-pressure sooner than is the case when the brake pedal is

depressed either before or at the same time as the brake lever is pulled.

### **Rear wheel lift**

Under very severe and sudden deceleration, however, under certain circumstances it is possible that the BMW Motorrad Integral ABS will be unable to prevent the rear wheel from lifting clear of the ground. If this happens the outcome can be a highside situation in which the motorcycle can flip over.



### **Rear wheel lift due to severe braking**

Risk of falling

- When you brake sharply, bear in mind that ABS control cannot always be relied on to prevent the rear wheel from lifting clear of the ground. ◀

## **What is the design baseline for BMW Motorrad Integral ABS?**

Within the limits imposed by physics, the BMW Motorrad Integral ABS ensures directional stability on any surface. The system is not optimised for special requirements that apply under extreme competitive situations off-road or on the track. The driving behaviour should be adapted to actual driving skills and the road conditions.

### **Special situations**

The speeds of the front and rear wheels are compared as one means of detecting a wheel's incipient tendency to lock. If the system registers implausible values for a lengthy period the ABS function is deactivated for safety reasons and an ABS fault message is issued. Self-dia-

gnosis has to complete before fault messages can be issued. In addition to problems with the BMW Motorrad ABS, exceptional riding conditions can also cause a fault message to be issued:

- Heating up with the motorcycle on the centre stand or an auxiliary stand, engine idling or with a gear engaged.
- Rear wheel locked by the engine brake for a lengthy period, for example while descending on a loose or slippery surface.

If a fault message is issued on account of exceptional riding conditions, you can reactivate the ABS function by switching the ignition off and on again.

## What significance devolves on regular maintenance?

### **WARNING**

#### **Brake system not regularly serviced.**

Risk of accident

- In order to ensure that the ABS is always maintained in optimum condition, it is essential for you to comply strictly with the specified inspection intervals. ◀

#### **Reserves for safety**

The potentially shorter braking distances which BMW Motorrad Integral ABS permits must not be used as an excuse for careless riding. ABS is primarily a means of ensuring a safety margin in genuine emergencies.

### **WARNING**

#### **Braking when cornering**

Risk of accident despite ABS

- Invariably, the rider bears responsibility for assessing road and traffic conditions and adopting his or her style of riding accordingly.
- Do not take risks that would negate the additional margin of safety offered by this system. ◀

#### **Evolution of ABS to ABS Pro**

– with ABS Pro<sup>OE</sup>

Until now, the BMW Motorrad ABS helped ensure a very high degree of safety for braking with the motorcycle upright and travelling in a straight line. Now ABS Pro offers enhanced safety for braking in corners as well. ABS Pro prevents the wheels from locking even under



sharp braking. ABS Pro reduces abrupt changes in steering force, particularly in panic-braking situations, counteracting the vehicle's otherwise natural but undesirable tendency to straighten up.

### ABS intervention

Technically speaking, depending on the riding situation ABS Pro adapts ABS intervention to the motorcycle's bank angle. Signals for rate of roll and rate of yaw and lateral acceleration are used to calculate bank angle.

As the motorcycle is heeled over more and more as it banks into a corner, an increasingly strict limit is imposed on the brake-pressure gradient for the start of brake application. This slows the build-up of brake pressure to a corresponding degree. Additionally, pressure modulation is more

uniform across the range of ABS intervention.

### Advantages for the rider

The advantages of ABS Pro for the rider are sensitive response and high braking and directional stability combined with best-case deceleration of the motorcycle, even when cornering.

### Traction control (ASC/DTC)

#### How does traction control work?

Traction control is available in two versions

- **without** provision for the bank angle: Automatic Stability Control ASC
- ASC is a rudimentary function intended to prevent falls.
- **with** provision for bank angle: Dynamic Traction Control DTC

– DTC regulation is more delicate and more comfortable thanks to the additional bank angle and acceleration information.

Traction control compares the front and rear wheel circumferential velocities. The differential is used to compute slip as a measure of the reserves of stability available at the rear wheel. If slip exceeds a certain limit, the engine management system intervenes and adapts engine torque accordingly.

BMW Motorrad ASC/DTC is designed as an assistant system for the rider and for use on public roads. The extent to which the rider affects ASC/DTC control can be considerable (weight shifts when cornering, items of luggage loose on the motorcycle), especially when the style of riding takes rider and machine

close to the limits imposed by physics.

Activate **Enduro** riding mode for off-roading. This mode delays ASC/DTC intervention slightly in order to permit controlled drifting. The system is not optimised for special requirements that apply under extreme competitive situations off-road or on the track. The BMW Motorrad ASC/DTC can be deactivated in these cases.



## WARNING

### Risky riding

Risk of accident despite ASC/DTC

- Invariably, it remains the rider's responsibility to adapt riding style to riding conditions.
- Do not take risks that would negate the additional safety offered by this system. ◀

## Special situations

In accordance with the laws of physics, the ability to accelerate is restricted more and more as the angle of heel increases. Consequently, there can be a perceptible reduction in acceleration out of very tight bends.

The speeds of the front and rear wheels are compared and DTC, unlike ASC, also takes the bank angle into account in processing data to detect the rear wheel's incipient tendency to spin or slip sideways.

- with riding modes Pro<sup>OE</sup>

If the electronic processor receives values for the bank angle that it considers implausible over a lengthy period, a dummy value is used for the bank angle or the DTC function is switched off.

Under these circumstances the indicator for a DTC fault shows.

Self-diagnosis has to complete before fault messages can be issued.

The BMW Motorrad Traction Control can shut down automatically under the exceptional riding conditions outlined below.

### Exceptional riding conditions:

- Riding for a lengthy period with the front wheel lifted off the ground (wheelie).
- Rear wheel rotating with the vehicle held stationary by applying the front brake (burn-out).
- Heating up with the motorcycle on an auxiliary stand, in neutral or with a gear engaged.

If the encoding plug is not inserted, the DTC is reactivated after a fault has occurred by switching the ignition off and on and then by continuing to drive at minimum speed.



Minimum speed for activation of DTC

min 5 km/h

If the front wheel lifts clear of the ground under severe acceleration, the ASC or DTC reduces engine torque in the RAIN and ROAD riding modes until the front wheel regains contact with the ground.

The ENDURO and ENDURO PRO riding modes are designed for the off-road mode and not suitable for the on-road mode.

In the DTC settings for DYNAMIC, DYNAMIC PRO and ENDURO, the front wheel lift-off detection allows for short wheelies.

In the DTC setting for ENDURO PRO, the front wheel lift-off detection is switched off.

In the RAIN, ROAD, DYNAMIC and ENDURO riding modes, the

DTC setting corresponds to the riding mode.

In the ENDURO PRO and DYNAMIC PRO riding modes, DTC can be set differently (➡ 85).

BMW Motorrad recommends turning the throttle grip back slightly when lifting the front wheel in order to reach a stable driving condition again as soon as possible.

When riding on a slippery surface, never snap the throttle grip fully closed without pulling the clutch at the same time. Engine braking torque can cause the rear wheel to skid, with a corresponding loss of stability. The BMW Motorrad DTC is unable to control a situation of this nature.

## Dynamic ESA

– with Dynamic ESA<sup>OE</sup>

### Riding position equaliser

The electronic chassis and suspension setting Dynamic ESA is able to adjust your motorcycle automatically to the load. If the spring preload is set to Auto, the rider does not have to change the load settings.

When driving off and when riding, the system monitors the suspension on the rear wheel and corrects the spring preload in order to set the riding position correctly. The damping is also adjusted automatically to the load.

Via ride height sensors, Dynamic ESA detects the movements in the chassis and suspension and responds by adjusting the EDC valves. The chassis and suspension will thus

be adapted to the characteristics of the terrain.

Dynamic ESA calibrates itself at regular intervals to ensure the system functions correctly.

## Possible settings

### Damping modes

- Road: Damping action for comfortable on-road riding
- Dynamic: Damping action for dynamic on-road riding
- Enduro: Damping action for off-road mode

### Load settings

- Auto: Active riding position equaliser with automatic adjustment of the spring preload and damping action
- Min: Minimum spring preload
- Max: Maximum spring preload (for off-road use)
- The Min and Max spring preloads can be selected by the rider but not changed. The rid-

ing position equaliser function is inactive when set to Min and Max.

## Riding mode

### Selection

To adjust the motorcycle to the road condition and the desired driving experience, the following riding modes can be selected:

- RAIN
- ROAD (standard mode)
- with riding modes Pro<sup>OE</sup>
- DYNAMIC
- ENDURO

When an encoding plug is installed, the **DYNAMIC PRO** and **ENDURO PRO** riding modes replace **DYNAMIC** and **ENDURO**.

For each of these riding modes there is a calibrated setting for the ABS, ASC and DTC sys-

tems as well as for the throttle response.

– with Dynamic ESA<sup>OE</sup>

The adjustment of the Dynamic ESA also depends on the riding mode selected.

In every riding mode, ABS and/or ASC/DTC can be switched off. The following explanations always refer to the driving safety systems that are switched on.

### Throttle response

- In RAIN and ENDURO riding modes: restrained
- In ROAD and ENDURO PRO riding modes: direct
- In DYNAMIC and DYNAMIC PRO riding modes: dynamic
- In the DYNAMIC PRO and ENDURO PRO riding modes, the throttle response can be

set differently via SETUP (▣▣▣ 82).

## **ABS**

- The rear wheel lift-off detection is activated in all riding modes.
- In RAIN, ROAD, DYNAMIC and DYNAMIC PRO riding modes, the ABS is set to on-road mode.
- In ENDURO riding mode, ABS is set to off-road mode with road tyres.
- with riding modes Pro<sup>OE</sup>
- There is no ABS control at the rear wheel when the footbrake lever is operated in ENDURO PRO riding mode. The ABS has been adjusted to off-road operation using studded tyres.
- In ENDURO PRO riding mode, ABS can be set differently via SETUP (▣▣▣ 82).
- In RAIN, ROAD, DYNAMIC and DYNAMIC PRO riding modes,

ABS Pro is fully available. The tendency of the motorcycle to straighten up when the brakes are applied with the machine banked for cornering is reduced to a minimum.

- In ENDURO riding mode, the assistance of ABS Pro is less than in the ROAD riding mode.
- ABS Pro is not available in ENDURO PRO riding mode.

## **ASC**

- The front wheel lift-off detection is activated in all riding modes.
- ASC is calibrated for on-road operation.
- ASC provides high driving stability in ROAD riding mode and maximum driving stability in RAIN riding mode.

– with riding modes Pro<sup>OE</sup>

## **DTC**

### **Tyres**

- In the DTC settings for RAIN, ROAD and DYNAMIC, DTC is calibrated to on-road mode with road tyres.
- In the DTC setting for ENDURO, DTC is calibrated to off-road mode with road tyres.
- In the DTC setting for ENDURO PRO, DTC is calibrated to off-road mode with lugged tyres.

### **Driving stability**

- In the DTC setting for RAIN, DTC intervenes early enough to achieve maximum driving stability.
- In the DTC setting for ROAD, DTC intervenes later than in the RAIN riding mode. This prevents the rear wheel from spinning whenever possible.

- In the DTC settings for RAIN and ROAD, the front wheel is prevented from lifting.
- In the DTC setting for DYNAMIC, DTC intervenes later than in the DTC setting for ROAD, meaning that the motorcycle may drift slightly when coming out of the corner or do short wheelies.
- In the DTC setting for ENDURO, DTC intervenes even later and is set to off-road mode so that longer drifts and short wheelies are possible when exiting corners.
- In the DTC setting for ENDURO PRO, DTC control assumes that studded tyres are used when off road. The front wheel lift-off detection is switched off, so that wheelies of any length and angle are possible. In extreme cases, the vehicle can rollover backwards!

In the RAIN, ROAD, DYNAMIC and ENDURO riding modes, the DTC setting corresponds to the riding mode.

In the ENDURO PRO and DYNAMIC PRO riding modes, DTC can be set differently (►► 85).

### Mode changes

The riding mode can be changed while the vehicle is stationary with the ignition on. It is possible to change it while driving under the following conditions:

- No drive torque on the rear wheel.
- No brake pressure in the brake system.

The following steps must be taken to change the riding mode:

- Close the throttle twistgrip.
- Release the brake levers.
- Deactivate the cruise control.

The desired riding mode is initially preselected. The mode change does not take place until the systems in question are all in the appropriate state.

The selection menu does not disappear from the display until the mode change has taken place.

### Dynamic Brake Control

- with riding modes Pro<sup>OE</sup>

### Dynamic Brake Control function



#### NOTICE

The Dynamic Brake Control function is active in all riding modes. It can only be deactivated in the RACE PRO riding modes by individually adjusting the ABS. ◀

The Dynamic Brake Control function assists the rider during emergency braking.

### **Detection of emergency braking**

- Emergency braking is detected when the front brake is actuated quickly and forcefully.

### **Behaviour during emergency braking**

- If emergency braking is initiated at a speed above 10 km/h, the Dynamic Brake Control takes effect in addition to the ABS function.
- If partial braking at high brake pressure gradients is initiated, the Dynamic Brake Control increases the integral brake pressure on the rear wheel. The stopping distance shortens and controlled braking is possible.

### **Behaviour during accidental actuation of the throttle grip**

- If, during emergency braking, the throttle grip is accidentally actuated (grip position > 5 %), the actual braking effect caused by the Dynamic Brake Control is guaranteed by closing the gas. The effect of emergency braking is guaranteed.
- If, during the intervention of the Dynamic Brake Control, the gas is closed (throttle grip position < 5 %), the engine torque requested by the ABS brake system is restored.
- If emergency braking finishes and the throttle grip is still actuated, the Dynamic Brake Control will reduce the engine torque to the driver's choice in a controlled manner.



### **NOTICE**

The function of the Dynamic Brake Control is switched off at the same time as the ABS is switched off. ◀

### **Tyre pressure control (RDC)**

- with tyre pressure control (RDC)<sup>OE</sup>

### **Function**

A sensor integrated into each tyre measures the air temperature and the air pressure inside the tyre and transmits this information to the control unit. The sensors are fitted with a centrifugal-force tripswitch which allows the measured values to be transmitted after the minimum speed is exceeded the first time.



Minimum speed for transmission of the RDC measured values:

min 30 km/h

The display shows -- for each tyre until the tyre-pressure signal is received for the first time. The sensors continue to transmit the measured-value signals for some time after the vehicle comes to a stop.



Transmission duration of the measured values after vehicle standstill:

min 15 min

An error message is issued if wheels without sensors are fitted to a vehicle equipped with an RDC control unit.

## Tyre pressure ranges

The RDC control unit distinguishes between three tyre pressure ranges matched to the vehicle:

- Filling pressure within the permissible tolerance
- Filling pressure in the limit range of the permissible tolerance
- Filling pressure outside permitted tolerance

## Temperature compensation

Tyre pressure is a temperature-sensitive variable: pressure increases as tyre-air temperature rises and decreases as tyre-air temperature drops. Tyre-air temperature depends on ambient temperature as well as on the style of riding and the duration of the ride.



The tyre pressures are shown in the TFT display as temperature compensated and always refer to the following tyre air temperature:

20 °C

The air lines available to the public in petrol stations and motorway service areas have gauges that do not compensate for temperature; the reading shown by a gauge of this nature is the temperature-dependent tyre-air pressure. As a result, the values displayed there usually do not correspond to the values displayed in the TFT display.

## Pressure adaptation

Compare the RDC value on the TFT display with the value in the table on the back cover of the Rider's Manual. Then use the air-line gauge at a service station



to compensate for the difference between the RDC reading and the value in the table.

 Example
According to the rider's manual, the tyre pressure should be the following value:
2.5 bar
The following display is shown in the TFT display:
2.3 bar
Missing:
0.2 bar
The tester on the filling station shows:
2.4 bar
The tyre pressure must be increased to the following value to reach the correct tyre pressure:

 Example
2.6 bar

## Shift assistant

- with riding modes Pro<sup>OE</sup>

### Shift assistant Pro

Your vehicle is equipped with a Pro shift assistant, a system originally developed for racing and now adapted for touring. It permits upshifts and downshifts without declutching or closing the throttle in virtually all load and rpm ranges.

### Advantages

- 70-80 % of all gearshifts on a trip can be done without using the clutch.
- Less relative movement between rider and passenger

because the shift pauses are shorter.

- It is not necessary to close the throttle valve when shifting under acceleration.
- When braking and downshifting (throttle valve closed), engine speed is adjusted by blipping the throttle.
- Shift time is shorter than a gearshift with clutch actuation.

In order for the system to identify a gearshift request, the rider has to move the gearshift lever from its idle position in the desired direction against the spring force through a certain "over-travel" at ordinary speed or rapidly and keep the gearshift lever in this position until the gearshift is completed. It is not necessary to increase the force applied to the shift lever while shifting is in progress. Once the gearshift has completed the shift lever has to

be fully released before another gearshift with the Pro shift assistant can take place. When shifting gears with the Pro shift assistant, the rider has to keep load state (throttle grip position) constant before and during the gearshift. A change in the position of the throttle grip during a gearshift can cause the function to abort and/or lead to a missed shift. The Pro shift assistant provides no assistance for the gearshift if the rider declutches.

### Downshifting

- Downshifting is assisted until maximum rpm for the target gear to be selected is reached. This prevents overrevving.



Maximum engine speed

max 9000 min<sup>-1</sup>

### Upshifting

- Upshifting is only possible when the current speed is higher than the respective release threshold of the next higher gear.
- This prevents the engine from dropping below idle speed.



Idle speed

1050 min<sup>-1</sup> (Engine at regular operating temperature)



Release thresholds

1st gear

min 1350 min<sup>-1</sup>

2nd gear

min 1400 min<sup>-1</sup>

3rd gear

min 1450 min<sup>-1</sup>

4th gear



Release thresholds

min 1500 min<sup>-1</sup>

5th gear

min 1550 min<sup>-1</sup>

6th gear

min 1600 min<sup>-1</sup>

## Hill Start Control

### Hill Start Control function

Hill Start Control assistant prevents the motorcycle from rolling backwards uncontrolled on gradients by intervening specifically with the ABS brake system without the driver having to constantly operate the brake lever. Pressure in the rear brake system is built up when Hill Start Control is activated in order to keep the motorcycle stationary on an incline.

The brake pressure in the brake system is dependent on the gradient.

### **Effect of an incline on brake pressure and drive-off behaviour**

- If the motorcycle is stopped on a gentle incline, only low brake pressure is built up. In this case, the brakes are quickly released when driving off. The motorcycle can be moved off more gently. It is not necessary to turn the throttle grip again.
- If the motorcycle is stopped on a steep incline, high brake pressure is built up. In this case, the brakes take longer to release when driving off. More torque is required for driving off which also requires the rider to turn the throttle grip again.

### **Behaviour when the motorcycle rolls or slips**

- If the motorcycle rolls when Hill Start Control is activated, the brake pressure is increased.
- If the rear wheel slips, the brake is released again after approx. 1 m. This prevents, for example, slipping due to a blocked rear wheel.

### **Releasing brake when stopping the engine or timeout**

Hill Start Control is deactivated when the engine is stopped using the emergency-off switch, when the side stand is folded out or after timeout (10 minutes). In addition to the indicator and warning lights, the rider should be made aware that Hill Start Control has been deactivated by the following behaviour:

### **Brake warning jolt**

- The brake is released briefly and reactivated immediately.
- This creates a jolt which the rider feels.
- The ABS brake system with partially integral function sets a speed of approx. 1-2 km/h.
- The rider must brake the motorcycle manually.
- After two minutes, or when the brake is actuated, Hill Start Control is completely deactivated.



### **NOTICE**

The holding pressure is released immediately without a brake warning jolt as soon as the ignition is switched off. ◀

## ShiftCam

### Functional principle of ShiftCam

The vehicle features BMW Shift-Cam technology for varying valve timing and valve lift on the intake side. The heart of this technology is a one-piece shifting intake camshaft that has two lobes for each valve: a partial-load cam and a full-load cam. The partial-load cam is fine-tuned for consumption optimisation and engine smoothness. As well as adapting valve timing, the partial-load cam also reduces intake-valve lift. With the partial-load cams activated, moreover, the lobes for the cylinder's left and right intake valves produce staggered valve lift and offset angles of rotation. Consequently the two intake valves open at very slightly different times and the distance to which they open

also differs. The advantage: The fuel/air mixture flowing into the combustion chamber is swirled more thoroughly and combusted effectively - so all in all the fuel is utilised more efficiently and engine operation is perceptibly smoother. The full-load cam is designed for optimised engine power and it maximises intake valve lift. The intake camshaft is shifted axially to vary valve timing and valve lift. The pins of an electromechanical actuator engage a shift gate on the intake camshaft. This permits load-dependent and speed-dependent actuation of the intake valves and, consequently, a no-compromises combination of performance and low fuel consumption.

## Maintenance

General instructions.....	172
Tool kit .....	172
Service tool kit.....	173
Front-wheel stand .....	173
Engine oil .....	174
Brake system .....	176
Clutch .....	180
Coolant .....	180
Tyres .....	181
Rims and tyres.....	182
Wheels .....	182
Air filter .....	189
Lighting.....	191
Jump-starting.....	193
Battery.....	194

Fuses .....	198
Diagnostic connector .....	200

## General instructions

The "Maintenance" chapter describes straightforward procedures for checking and replacing certain wear parts.

Special tightening torques are listed as applicable. The tightening torques for the threaded fasteners on your vehicle are listed in the section entitled "Technical data".

You will find information on more extensive maintenance and repair work in the Repair Manual on DVD for your vehicle, which is available from your authorised BMW Motorrad Retailer.

Some of the work calls for special tools and a thorough knowledge of the technology involved. If you are in doubt, consult a specialist workshop, preferably your authorised BMW Motorrad Retailer.

## Tool kit

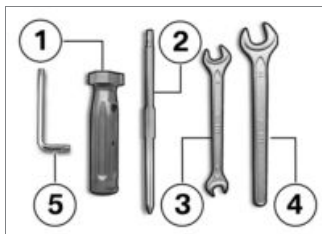

- 1** Screwdriver handle
  - Use with screwdriver insert.
  - Topping up the engine oil (➡ 175).
- 2** Reversible screwdriver blade
  - Phillips PH1 and Torx T25
  - Removing bulbs for front and rear turn indicators (➡ 191).
  - Removing battery cover (➡ 196).
  - Top up coolant (➡ 181).

- 3** Open-ended spanner
  - Width across flats 8/10
  - Removing battery (➡ 196).
- 4** Open-ended spanner
  - Width across flats 14
  - Adjusting mirror arm (➡ 124).
- 5** Torx wrench, T30
  - Adjusting the lower gear-shift lever.

## Service tool kit

– with service toolkit<sup>OA</sup>

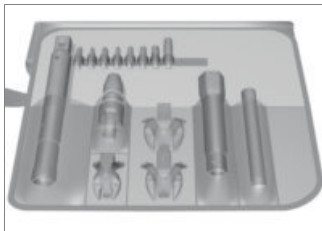

BMW Motorrad has put together a service tool set suitable for your motorcycle for more advanced service operations (e.g. removing and refitting the wheels). This tool set is available from your authorised BMW Motorrad Retailer.

## Front-wheel stand

### Installing the front-wheel stand

#### ATTENTION

#### Use of the BMW Motorrad front wheel stand without accompanying use of centre stand or auxiliary stand

Risk of damage to parts if vehicle topples

- Place the motorcycle on its centre stand or another auxiliary stand before lifting the front wheel with the BMW Motorrad front-wheel stand.◀
- Make sure the ground is level and firm and place the motorcycle on its centre stand.
- Use basic stand with front-wheel adapter. The basic stand and its accessory components are available from your

BMW Motorrad authorised dealer.

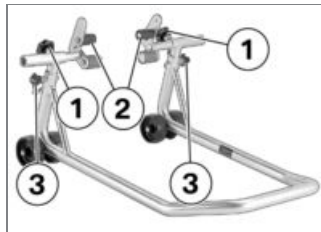

- Undo bolts **1**.
- Push the two adapters **2** apart until the front forks fit between them.
- Use retaining pins **3** to set the front-wheel stand to the desired height.
- Centre the front-wheel stand relative to the front wheel and push it against the front axle.

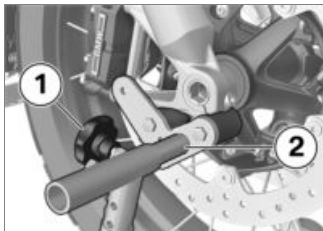

- Align the two adapters **2** so that the front forks are securely seated.
- Tightening **1** bolts.

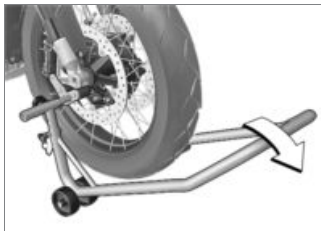

### ATTENTION

#### **Centre stand retracts if motorcycle is lifted too high**

Risk of damage to parts if vehicle topples

- When raising the vehicle, make sure that the centre stand remains on the ground.◀
- Apply uniform pressure to push the front-wheel stand down and raise the motorcycle.

## Engine oil

### Checking engine oil level

#### NOTICE

Incorrect interpretation of the oil capacity is possible because the oil level is temperature-dependent.◀

- Make sure the ground is level and firm and place the motorcycle (at operating temperature) on its centre stand.
  - with Style HPO<sup>OE</sup>
- Make sure the engine is at operating temperature and hold the motorcycle upright.◀
- Let engine idle until the fan turns on.
- Switch off the engine when it is at operating temperature.
- Wait five minutes for the oil to drain into the oil pan.



## NOTICE

To protect the environment, BMW Motorrad recommends occasionally checking the engine oil after a journey of at least 50 km. ◀

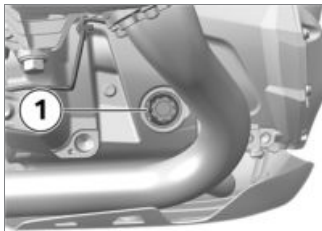

- Check the oil level in the display **1**.

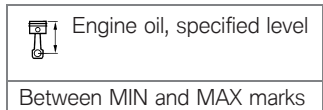

If the oil level is below the MIN mark:

- Topping up the engine oil (► 175).

If the oil level is above the MAX mark:

- Have the oil level corrected by a specialist workshop, preferably an authorised BMW Motorrad dealer.

## Topping up the engine oil

- Place the motorcycle on its stand on firm, even ground.

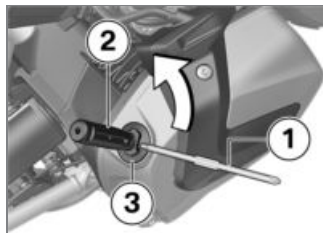

- Wipe the area around the oil filler opening clean.
- Insert Torx end of reversible screwdriver insert **1** into screwdriver handle **2** (toolkit) for additional leverage.
- Engage this tool in cap **3** of the oil filler opening and turn anti-clockwise to remove.
- Checking engine oil level (► 174).

**ATTENTION****Use of insufficient engine oil or too much engine oil**

Engine damage

- Always make sure that the oil level is correct. ◀
- Top up the engine oil to the specified level.



Engine oil, quantity for topping up

max 0.8 l (Difference between MIN and MAX)

- Checking engine oil level (▶▶ 174).
- Install cap **3** of the oil filler opening.

**Brake system****Checking function of brakes**

- Pull the front brake lever.

» The pressure point must be clearly perceptible.

- Press the footbrake lever.

» The pressure point must be clearly perceptible.

If pressure points are not clearly perceptible:

**ATTENTION****Work on brake system not in compliance with correct procedure**

Risk to operational reliability of the brake system

- Have all work on the brake system undertaken by trained and qualified specialists. ◀
- Have the brakes checked by a specialist workshop, preferably an authorised BMW Motorrad dealer.

**Checking front brake pad thickness**

- Place the motorcycle on its stand on firm, even ground.



- Visually inspect the left and right brake pads to ascertain their thickness. Viewing direction: between wheel and front suspension toward brake pads **1**.

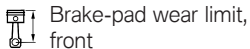

Brake-pad wear limit,  
front

1.0 mm (Friction pad only,  
without backing plate. The  
wear indicators (grooves) must  
be clearly visible.)

If the wear indicating marks are  
no longer clearly visible:

## **WARNING**

### **Brake-pad thickness less than permissible minimum**

Diminished braking effect, dam-  
age to the brakes

- In order to ensure the dependability of the brake system, do not permit the brake pads to wear past the minimum permissible thickness.◀
- Have the brake pads replaced by a specialist workshop, preferably an authorised BMW Motorrad Retailer.

### **Check the rear brake pad thickness**

- Make sure the ground is level and firm and place the motorcycle on its stand.



- Visually inspect the brake pads to ascertain their thickness. Viewing direction: between spray guard and rear wheel toward brake pads **1**.



 Brake-pad wear limit,  
rear

1.0 mm (Friction pad only,  
without backing plate.)

If the wear limit has been  
reached:

### **WARNING**

#### **Brake-pad thickness less than permissible minimum**

Diminished braking effect, dam-  
age to the brakes

- In order to ensure the depend-  
ability of the brake system, do  
not permit the brake pads to

wear past the minimum per-  
missible thickness. ◀

- Have the brake pads replaced  
by a specialist workshop,  
preferably an authorised  
BMW Motorrad dealer.

### **Checking brake-fluid level, front brakes**

#### **WARNING**

#### **Not enough brake fluid in brake fluid tank**

Considerably reduced braking  
power due to air in the brake  
system

- Adjust the riding mode imme-  
diately until the fault is rectified.
- Check the brake-fluid level at  
regular intervals. ◀
- Make sure the ground is level  
and firm and place the motor-  
cycle on its centre stand.

- Move the handlebars to the  
straight-ahead position.



- Check the brake fluid level in  
front reservoir **1**.

#### **NOTICE**

Wear of the brake pads causes  
the brake fluid level in the reser-  
voir to sink. ◀



Brake fluid level, front

Brake fluid, DOT4

It is impermissible for the brake fluid level to drop below the MIN mark. (Brake-fluid reservoir horizontal, motorcycle upright)

If the brake fluid level drops below the permitted level:

- Have the defect rectified as quickly as possible by a specialist workshop, preferably an authorised BMW Motorrad dealer.

## Checking the brake-fluid level, rear brakes

### WARNING

#### Not enough brake fluid in brake fluid tank

Considerably reduced braking power due to air in the brake system

- Adjust the riding mode immediately until the fault is rectified.
- Check the brake-fluid level at regular intervals. ◀
- Make sure the ground is level and firm and place the motorcycle on its centre stand.



- Check the brake fluid level in rear reservoir **1**.



### NOTICE

Wear of the brake pads causes the brake fluid level in the reservoir to sink. ◀



Brake fluid level, rear

Brake fluid, DOT4

It is impermissible for the brake fluid level to drop below the MIN mark. (Brake-fluid reservoir horizontal, motorcycle upright)

If the brake fluid level drops below the permitted level:

- Have the defect rectified as quickly as possible by a specialist workshop, preferably an authorised BMW Motorrad dealer.

## Clutch

### Checking clutch function

- Pull the clutch lever.
    - » The pressure point must be clearly perceptible.
- If the pressure point is not clearly perceptible:
- Have the clutch checked by a specialist workshop, preferably an authorised BMW Motorrad dealer.

## Coolant

### Check coolant level



**CAUTION**

### Working on hot cooling system

Risk of burn injury

- Always allow the cooling system to cool down before starting work. ◀

- Place the motorcycle on its stand on firm, even ground.



- Check the coolant level in expansion tank **1**.
- If the coolant drops below the permitted level:
- Top up the coolant.

## Top up coolant



- Remove bolt **1** and lid **2**.



- Open cap **1** of the coolant expansion tank **2** and top up the coolant to the specified level.
- Check coolant level (☞ 180).

- Close the cap of the coolant expansion tank.



- Position the lid **1**.
- Fit bolt **2**.

## Tyres

### Checking tyre pressure

**! WARNING**

#### Incorrect tyre pressure

Impaired handling characteristics of the motorcycle, shorter useful tyre life

- Always check that the tyre pressures are correct. ◀

**! WARNING**

#### Tendency of valve inserts installed vertically to open by themselves at high riding speeds

Sudden loss of tyre pressure

- Install valve caps fitted with rubber sealing rings and tighten firmly. ◀
- Make sure the ground is level and firm and place the motorcycle on its stand.
- Check tyre pressures against the data below.

 Tyre pressure, front

2.5 bar (tyre cold)

 Tyre pressure, rear

2.9 bar (tyre cold)

If tyre pressure is too low:

- Correct tyre pressure.

## Rims and tyres

### Checking rims

- Make sure the ground is level and firm and place the motorcycle on its stand.
- Visually inspect the rims for defects.
- Have any damaged rims inspected by a specialist workshop and replaced if necessary, preferably by an authorised BMW Motorrad dealer.

### Checking tyre tread depth



#### WARNING

#### Riding with badly worn tyres

Risk of accident due to impaired handling

- If applicable, have the tyres changed in good time before

they wear to the minimum tread depth permitted by law. ◀

- Make sure the ground is level and firm and place the motorcycle on its stand.
- Measure the tyre tread depth in the main tread grooves with wear marks.



#### NOTICE

Wear indicators are built into the main profile grooves on each tyre. The tyre is worn out when the tyre tread has worn down to the level of the marks. The locations of the marks are indicated on the edge of the tyre, e.g. by the letters TI, TWI or by an arrow. ◀

If the tyre tread is worn to minimum:

- Replace tyre or tyres, as applicable.

## Check spokes

- Make sure the ground is level and firm and place the motorcycle on its stand.
- Draw the handle of a screwdriver or a similar instrument across the spokes and listen to the notes of the individual spokes.

If the notes vary:

- Have the spokes checked by a specialist workshop, preferably an authorised BMW Motorrad dealer.

## Wheels

### Effect of wheel size on chassis and suspension control systems

Wheel size is very important as a parameter for the chassis and suspension control systems ABS and ASC. In particular, the diameter and the width of a vehicle's wheels are pro-



grammed into the control unit and are fundamental to all calculations. Any change in these influencing variables, caused for example by a switch to wheels other than those installed ex-works, can have serious effects on the performance of the control systems.

The sensor rings are essential for correct road-speed calculation, and they too must match the motorcycle's control systems and consequently cannot be changed.

If you decide that you would like to fit non-standard wheels to your motorcycle, it is very important to consult a specialist workshop beforehand, preferably an authorised BMW Motorrad dealer. In some cases, the data programmed into the control units can be changed to suit the new wheel sizes.

## RDC label

- with tyre pressure control (RDC)<sup>OE</sup>

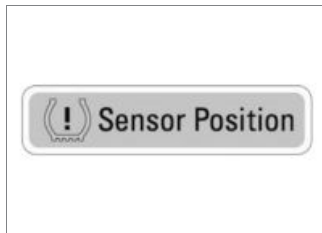

## ATTENTION

### **Tyre removal not in compliance with correct procedure**

Damage to RDC sensors

- Be sure to explain to the specialist workshop or authorised BMW Motorrad dealer that the wheel is fitted with an RDC sensor.◀

If the motorcycle is equipped with RDC, each wheel rim bears

an adhesive label indicating the position of the RDC sensor. When changing the tyre, take care not to damage the RDC sensor. Be sure to draw the attention of the authorised BMW Motorrad dealer or specialist workshop to the fact that the wheel is fitted with an RDC sensor.

## **Removing front wheel**

- Make sure the ground is level and firm and place the motorcycle on its centre stand.

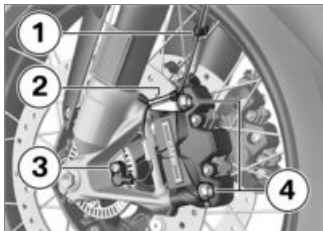

- Disengage the cable for the wheel speed sensor from holding clips **1** and **2**.
- Remove bolt **3** and remove the wheel speed sensor from its bore.
- Mask off the parts of the wheel rim that could be scratched in the process of removing the brake calipers.



### ATTENTION

#### Unwanted inward movement of the brake pads

Component damage on attempt to install the brake caliper or be-

cause brake pads have to be forced apart

- Do not operate the brakes with a brake caliper not correctly secured. ◀
- Remove mounting bolts **4** of the left and right brake calipers.

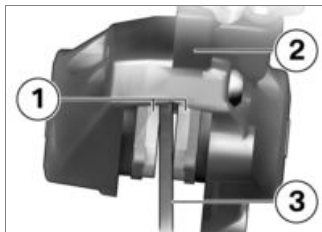

- Force the brake pads **1** slightly apart by rotational movement of the brake caliper **2** against brake disc **3**.
- Carefully pull the brake calipers back and out until clear of the brake discs.

- Lift the front of the motorcycle until the front wheel is clear of the ground, preferably using a BMW Motorrad front-wheel stand.
- Installing the front-wheel stand (▶▶ 173).



- Undo right axle clamping screw **1**.

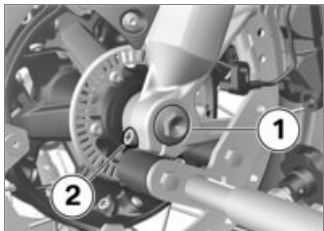

- Remove the bolt **1**.
- Undo left axle clamping screw **2**.
- Press quick-release axle slightly toward the inside, so as to be better able to grip it on the right-hand side.

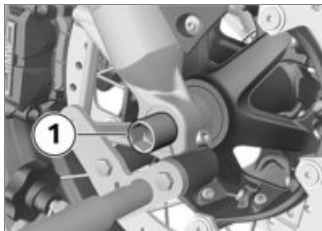

- Withdraw quick-release axle **1**, support the front wheel when doing this.
- Set down front wheel and roll forwards out of the front suspension.

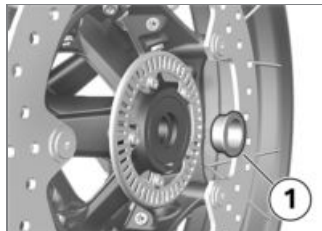

- Remove spacer bush **1** from the wheel hub.

## Installing front wheel

### **WARNING**

#### **Use of a non-standard wheel**

Malfunctions during ABS and ASC/DTC intervention

- See the information on the effect of wheel size on the ABS and ASC/DTC systems at the start of this chapter.◀

## ATTENTION

### Tightening threaded fasteners to incorrect tightening torque

Damage, or threaded fasteners work loose

- Always have the security of the fasteners checked by a specialist workshop, preferably an authorised BMW Motorrad dealer. ◀

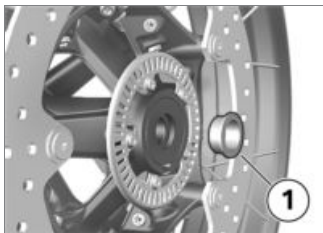

- Insert spacer bush **1** into the wheel hub on the left-hand side.

## ATTENTION

### Front wheel installed wrong way round

Risk of accident

- Note direction-of-rotation arrows on tyre or rim. ◀
- Roll the front wheel into position between the front suspension.

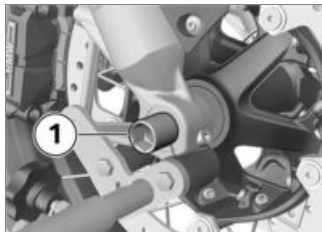

- Lift front wheel and install quick-release axle **1**.
- Remove front-wheel stand and firmly compress front forks

several times. Do not operate handbrake lever.

- Installing the front-wheel stand (▶▶ 173).

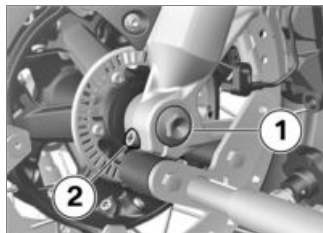

- Install bolt **1** and tighten to specified torque. Counter-hold quick-release axle on the right-hand side.



Quick-release axle in the telescopic forks

30 Nm

- Tighten left axle clamping screw **2** to specified torque.

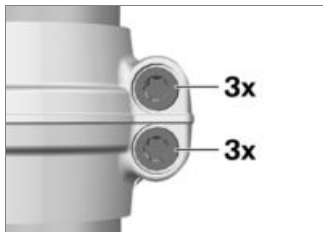

 Fork bridge, lower, to slider tube

Tightening sequence: Tighten screws six times in alternate sequence

19 Nm



- Tighten right axle clamping screw **1** to specified torque.

 Clamping screw for quick-release axle in telescopic fork

19 Nm

- Remove the front-wheel stand.
- Position left and right brake calipers on the brake discs.

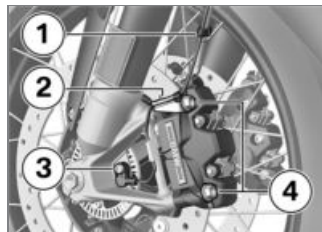

- Install mounting bolts **4** on left and right and tighten to specified torque.

 Brake caliper to telescopic fork

38 Nm

- Remove the adhesive tape from the wheel rim.

## WARNING

### Brake pads not lying against the brake disc

Risk of accident due to delayed braking effect.

- Before driving, check that the brakes respond without delay. ◀
- Operate the brake several times until the brake pads are bedded.
- Insert the cable for the wheel speed sensor into holding clips **1** and **2**.
- Insert the wheel speed sensor into the bore hole and install bolt **3**.

 Wheel-speed sensor to fork leg

Joining compound: Micro-encapsulated or medium-strength thread-locking compound



Wheel-speed sensor to fork leg

8 Nm

## Removing rear wheel

- Make sure the ground is level and firm and place the motorcycle on its centre stand.
- Engage first gear.

## CAUTION

### Hot exhaust system

Risk of burn injury

- Do not touch a hot exhaust system. ◀
- Allow rear silencer to cool down.

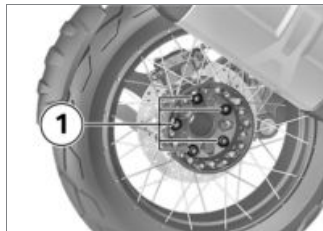

- Remove bolts **1** from the rear wheel, while supporting the wheel.
- Roll the rear wheel out toward the rear.

## Installing the rear wheel

## WARNING

### Use of a non-standard wheel

Malfunctions during ABS and ASC/DTC intervention

- See the information on the effect of wheel size on the ABS and ASC/DTC systems at the start of this chapter. ◀



## ATTENTION

### Tightening threaded fasteners to incorrect tightening torque

Damage, or threaded fasteners work loose

- Always have the security of the fasteners checked by a specialist workshop, preferably an authorised BMW Motorrad dealer. ◀
- Seat the rear wheel on the rear-wheel adapter.

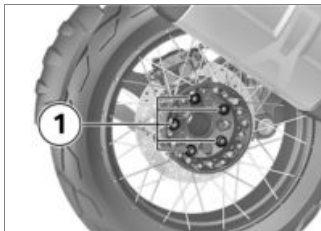

## WARNING

### Mixed installation of wheel studs for spoked wheel and cast wheel

Risk of accident

- Use only wheel studs with the same, approved length code.
- Do not lubricate the wheel studs. ◀
- Install wheel bolts **1** and tighten to specified torque.



Rear wheel to wheel flange

Tightening sequence: tighten in diagonally opposite sequence

60 Nm

## Air filter

### Replacing air-filter element

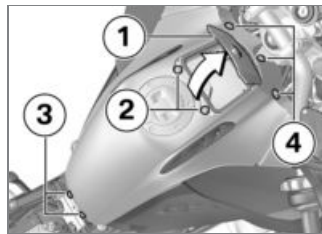

- Remove front seat (→ 97).
- Open the storage compartment cover **1**.

- Remove the screws **2, 3** and **4**.
- Remove the tank cover.



- Remove the screws **1**.
- Remove the air filter body cover.

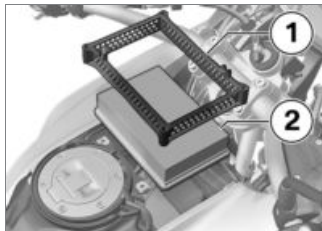

- Remove the frame **1**.
- Remove the air filter insert **2**.

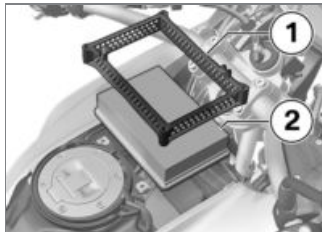

- Remove frame **1** and air filter element **2**.
- Insert new air filter element **2** and frame **1**.

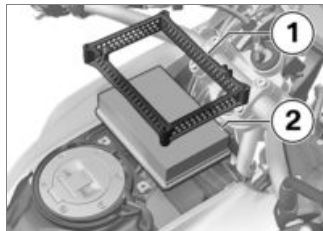

- Clean the air filter insert **2** or replace if necessary.
- Insert the air filter insert **2** and frame **1**.

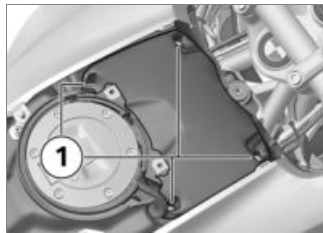

- Place the air filter body cover.
- Install screws **1**.



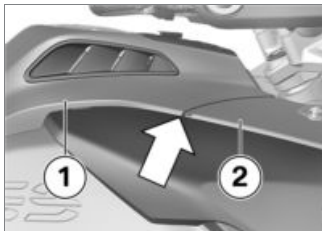

- Position the tank cover **1**; when fitting it make sure that the guide (**arrow**) is below the front-wheel cover above **2**.

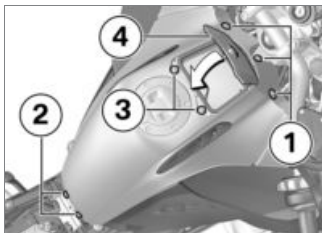

- Install screws **1**, **2** and **3**.

- Open the storage compartment cover **4**.
- Installing front seat (→ 98).

## Lighting

### Replacing bulbs for front and rear turn indicators

- without LED flashing turn indicator<sup>OE</sup>
- Place the motorcycle on its stand on firm, even ground.
- Switch off the ignition.



- Remove the bolt **1**.



- Pull the glass out of the reflector housing at the threaded-fastener side.

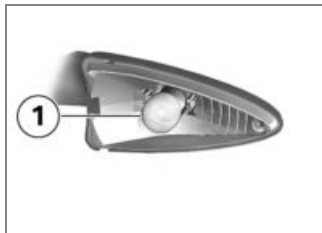

- Remove bulb **1** by turning anti-clockwise from the mirror housing.◁

- Replace the defective bulb.

 Bulbs for flashing turn indicators, front

RY10W / 12 V / 10 W

– with LED flashing turn indicator<sup>OE</sup>

LED<

 Bulbs for flashing turn indicators, rear

RY10W / 12 V / 10 W

– with LED flashing turn indicator<sup>OE</sup>

LED<

- Use a clean, dry cloth to hold the new bulb in order to keep the glass free of foreign matter.

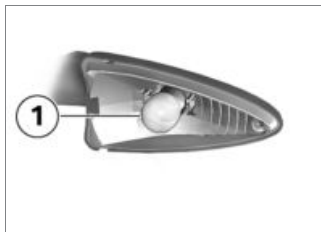

- Turn bulb **1** clockwise to install it in the mirror housing.



- Working from the inboard side, insert the glass into the mirror housing and close the housing.



- Install screw **1**.

### Replace LED flashing turn indicators

– with LED flashing turn indicator<sup>OE</sup>

- LED flashing turn indicators can only be replaced as a complete unit. Consult a specialist workshop, preferably an authorised BMW Motorrad dealer.

## Replacing LED rear light

The LED rear light can be replaced only as a complete unit.

- Consult a specialist workshop, preferably an authorised BMW Motorrad dealer.

## Replacing the LED headlight

- LED headlights can only be replaced as a complete unit. Consult a specialist workshop, preferably an authorised BMW Motorrad Retailer.

## Replacing LED auxiliary headlights

– with LED additional headlight<sup>OA</sup>

The LED auxiliary headlights can only be replaced as a unit; it is not possible to replace individual LEDs.

Consult a specialist workshop, preferably an authorised BMW Motorrad dealer.

## Jump-starting



### ATTENTION

#### Excessive current flowing when the motorcycle is jump-started

Wiring smoulders/ignites or damage to the on-board electronics

- If the motorcycle has to be jump-started connect the leads to the battery terminals; never attempt to jump-start the engine by connecting leads to the on-board socket. ◀



### ATTENTION

#### Contact between crocodile clips of jump leads and vehicle

Risk of short-circuit

- Use jump leads fitted with fully insulated crocodile clips at both ends. ◀



### ATTENTION

#### Jump-starting with a voltage greater than 12 V

Damage to the on-board electronics

- Make sure that the battery of the donor vehicle has a voltage rating of 12 V. ◀
- Place the motorcycle on its stand on firm, even ground.
- Removing battery cover (▶▶ 196).
- When jump-starting the engine, do not disconnect the battery from the on-board electrical system.

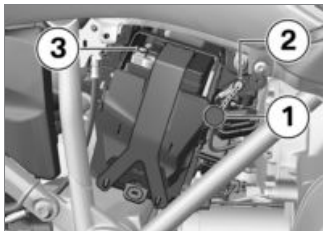

- Remove the protective cap **1**.
- Use the red jump lead to connect the positive battery connection point **2** of the drained battery to the positive terminal of the donor battery.
- Then connect one end of the black jump lead to the negative terminal of the donor battery, and the other end to the negative terminal **3** of the drained battery.
- Run the engine of the donor vehicle during jump-starting.
- Start the engine of the vehicle with the discharged battery in the usual way; if the en-

gine does not start, wait a few minutes before repeating the attempt in order to protect the starter motor and the donor battery.

- Allow both engines to idle for a few minutes before disconnecting the jump leads.
- Disconnect the jump lead from the negative terminals first, then disconnect the second lead from the positive terminals.



#### NOTICE

Do not use proprietary start-assist sprays or other products to start the engine.◀

- Install the protective cap.
- Fitting battery cover (▮▶ 198).

## Battery

### Maintenance instructions

Correct upkeep, recharging and storage will prolong the life of the battery and are essential if warranty claims are to be considered.

Compliance with the points below is important in order to maximise battery life:

- Keep the surface of the battery clean and dry.
- Do not open the battery.
- Do not top up with water.
- Be sure to read and comply with the instructions for charging the battery on the following pages.
- Do not turn the battery upside down.

## **ATTENTION**

### **On-board electronics (e.g. clock) draining connected battery**

Battery is deep-discharged; this voids the guarantee

- Connect a float charger to the battery if the motorcycle is to remain out of use for more than four weeks. ◀

## **NOTICE**

BMW Motorrad has developed a float charger specially designed for compatibility with the electronics of your motorcycle. Using this charger, you can keep the battery charged during long periods of disuse, without having to disconnect the battery from the motorcycle's on-board systems. You can obtain additional information from your authorised BMW Motorrad dealer. ◀

### **Charge battery when connected**

## **ATTENTION**

### **Charging the battery that is connected to the vehicle via the battery terminals**

Damage to the on-board electronics

- Disconnect the battery at the battery terminals before charging. ◀

## **ATTENTION**

### **Recharging a fully discharged battery via the power socket or extra socket**

Damage to the vehicle electronics

- If a battery has discharged to the extent that it is completely flat (battery voltage less than 12 V, indicator lights and multifunction display remain off when the ignition is switched

on) always charge the **disconnected** battery with the charger connected directly to the battery terminals. ◀

## **ATTENTION**

### **Unsuitable chargers connected to a socket**

Damage to charger and vehicle electronics

- Use suitable BMW chargers. The suitable charger is available from your authorised BMW Motorrad dealer. ◀
- Charge via the charging socket, with the battery connected to the motorcycle's on-board electrical system.

## **NOTICE**

The motorcycle's on-board electronics know when the battery is fully charged. The on-board socket is switched off when this happens. ◀

- Comply with the operating instructions of the charger.

### NOTICE

If you are unable to charge the battery through the on-board socket, you may be using a charger that is not compatible with your motorcycle's electronics. In this case, directly charge the battery at the terminals of the battery that has been disconnected from the vehicle. ◀

### Charging battery when disconnected

- Charge the battery using a suitable charger.
- Comply with the operating instructions of the charger.
- Once the battery is fully charged, disconnect the charger's terminal clips from the battery terminals.

### NOTICE

The battery has to be recharged at regular intervals in the course of a lengthy period of disuse. See the instructions for caring for your battery. Always fully recharge the battery before restoring it to use. ◀

### Removing battery

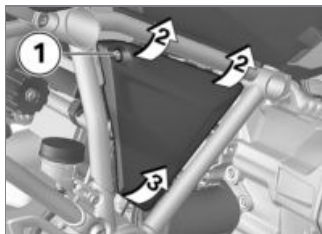

- Switch off the ignition.
- Remove screw **1**.
- Each battery cover slightly forward at the top at positions **2**.

- In order not to damage the battery cover or the mount, work the battery cover up at position **3** to remove.

- with anti-theft alarm (DWA)<sup>OE</sup>
- If applicable, switch off the anti-theft alarm. ◀

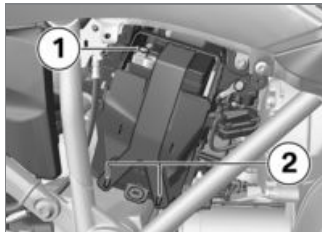

- Disconnect battery earth lead **1** and disengage rubber strap **2**.



- Pull retaining panel in position **1** outwards and remove in an upward direction.
- Slightly lift the battery and ease it clear of the holder until the battery positive terminal is accessible.

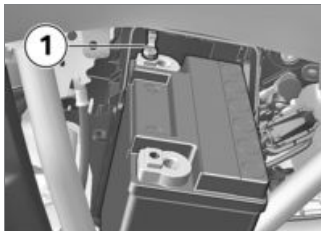

- Disconnect battery negative lead **1** and remove the battery.



- Secure battery positive lead **1**.
- Push battery into the mounting.

## Installing battery

### NOTICE

The fuse for the alternator regulator can blow if the 12 V battery is installed incorrectly or if the terminals are swapped (e.g. when using a starting aid).◀

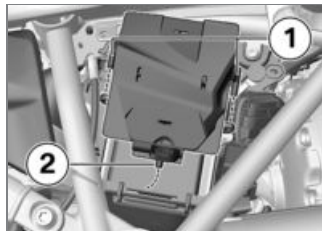

- First insert retaining plate into the mountings **1** and then push under the battery in position **2**.



- Secure battery negative lead **1**.
- Secure the battery with rubber strap **2**.

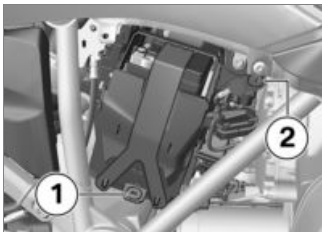

- Position the battery cover in the mounting **1** and press it into the mounting **2**.



- Install screw **1**.
- Setting the clock (☞ 111).
- Setting the date (☞ 111).

## Fuses

### Replace fuses

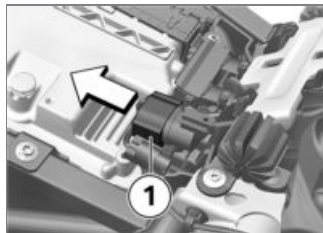

- Switch off the ignition.
- Remove front seat (☞ 97).
- Pull off connector **1**.



### ATTENTION

#### Jumpering of blown fuses

Risk of short-circuit and fire

- Never attempt to jumper a blown fuse.
- Always replace a defective fuse with a new fuse of the same amperage.◀



- Replace faulty fuse in accordance with the fuse allocation diagram.



## NOTICE

If fuse defects recur frequently have the electric circuits checked by a specialist workshop, preferably an authorised BMW Motorrad dealer. ◀

- Install plug **1**.
- Installing front seat (► 98).

## Fuse assignment

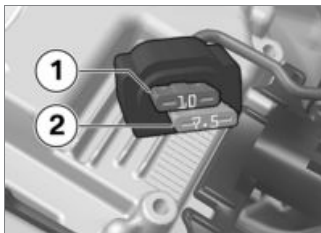

- |          |  |
|----------|--|
| <b>1</b> | 10 A<br>Instrument panel<br>Anti-theft alarm (DWA)<br>Ignition switch<br>Diagnostic socket |
| <b>2</b> | 7.5 A<br>Multifunction switch, left<br>Tyre pressure monitoring (RDC)                      |

## Fuse for the alternator regulator

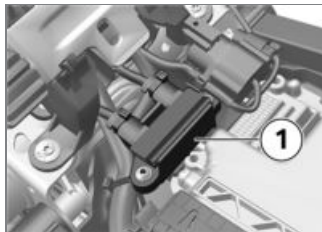

- |          |                              |
|----------|------------------------------|
| <b>1</b> | 50 A<br>Alternator regulator |
|----------|------------------------------|

## Diagnostic connector

### Disengaging diagnostic connector

#### CAUTION

#### Incorrect procedure followed when loosening the diagnostic connector for the on-board diagnosis

Motorcycle experiences malfunctions

- Only have the diagnostic connector loosened by a specialist workshop or other authorised persons during your next BMW Service appointment.
- Have the work performed by appropriately trained staff.
- Refer to the vehicle manufacturer specifications.◀
- Removing battery cover (▶▶ 196).



- Press the hook **1** and pull the diagnostic connector **2** out upwards.

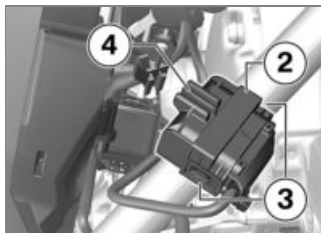

- Press the latches **3** on both sides.

- Disengage diagnostic connector **2** from holder **4**.
- » The interface to the diagnosis and information system can be connected to diagnostic connector **2**.

#### Securing the diagnostic connector

- Disconnect the interface for the diagnosis and information system.

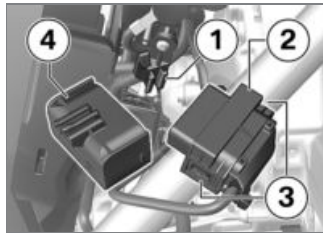

- Seat diagnostic connector **2** in bracket **4**.
- » The locks **3** engage on both sides.

- Seat the bracket **4** on the mounting **1**.



- Make sure the hook **5** has engaged.
- Fitting battery cover (▶▶▶ 198).



## **Accessories**

General instructions.....	204
Power sockets .....	204
Cases.....	205
Topcase .....	207
Navigation system .....	209

## General instructions

### CAUTION

#### Use of other-make products

Safety risk

- BMW Motorrad cannot examine or test each product of outside origin to ensure that it can be used on or in connection with BMW vehicles without constituting a safety hazard. Country-specific official authorisation does not suffice as assurance. Tests conducted by these instances cannot make provision for all operating conditions experienced by BMW vehicles and, consequently, they are not sufficient in some circumstances.
- Use only parts and accessories approved by BMW for your vehicle. ◀

The components and accessory products have been thoroughly

checked by BMW for safety, function and suitability. BMW therefore takes responsibility for the products. BMW does not accept liability for unauthorised parts and accessory products of any kind.

Legal provisions must be taken into account when any changes are made. Please refer to the road traffic licensing regulations (in Germany StVZO) for your country.

Your BMW Motorrad Retailer offers you qualified advice when choosing original BMW components, accessories and other products.

To find out more about accessories, go to:

**[bmw-motorrad.com/equipment](http://bmw-motorrad.com/equipment)**

## Power sockets

### Connection of electrical devices

- You can start using electrical devices connected to the motorcycle's sockets only when the ignition is switched on.

### Cable routing

- The cables from the power sockets to the auxiliary devices must be routed in such a way that they do not impede the rider.
- The cable routing should not restrict the steering angle or obstruct handling.
- The cables must not be trapped.

### Automatic shutdown

- The sockets will be automatically switched off during the start procedure.

- The power supply to the sockets is switched off no more than 15 minutes after the ignition is switched off, in order to prevent overloading of the on-board electrics. Low-wattage electrical accessories might not be recognised by the vehicle's electronics. In such cases, power sockets are switched off very shortly after the ignition is turned off.
- If the battery charge state is too low to maintain the motorcycle's start capability, the power sockets are switched off.
- The power sockets are also switched off when the maximum load capability as stated in the technical data is exceeded.

## Cases

- with aluminium case<sup>OA</sup>

### Open cases

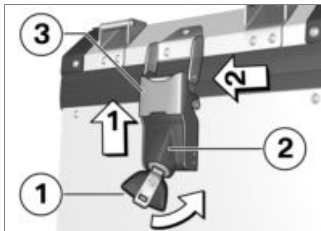

- Turn key **1** counter-clockwise.

### NOTICE

The case lid can be opened at either the left or the right latch. ◀

- Push lock housing **2** upwards in order to release the catch **3**.
- Pull the latch **3** to one side and open the lid.

### Closing cases

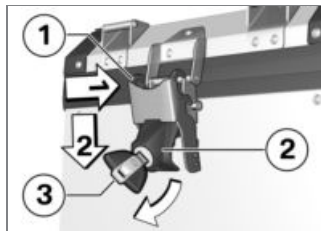

- Close the case lid.
- Set the latch **1** on the lid.
- Push lock housing **2** down, making sure that the latch toggle grips firmly in the lid.
- To lock the lock, turn key **3** clockwise and remove it.

### Remove case lid

- Open cases (▣ 205).



- Disengage retainer **1**.
- Close the case lid.
- Open the second catch of the case lid.
- Remove the case lid.

### Install case lid

- Place the case lid on the case.
- Close one latch of the case lid.
- Using the locked side as a hinge, open the case lid.



- Engage retainer **1**.
- Close the case lid.
- Close the second latch of the case lid.

### Removing cases

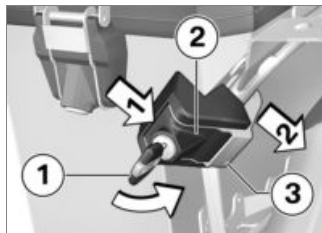

- Turn key **1** counter-clockwise.

- Push lock housing **2** to one side in order to release the catch **3**.
- Push the latch **3** to one side while holding the case.
- Pull the case forward as far as it will go and then to the side to remove.

### Install cases

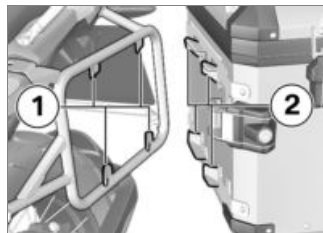

- Set the case on the case carrier and push it to the rear in such a way that mounts on case carrier **1** and on case **2** engage each other.



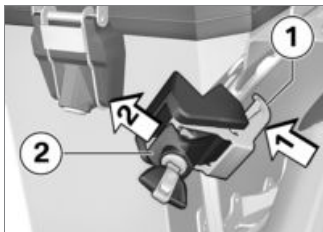



- Place the latch **1** on the case holder while holding the case.
- Push lock housing **2** to the side, making sure that the latch toggle grips firmly on the carrier.
- Turn the key clockwise and remove.

## Maximum payload and maximum speed

Note the maximum permissible payload and the speed limit for riding with cases fitted, as stated on the label inside the case.

Contact your authorised BMW Motorrad Retailer if you

cannot find your combination of vehicle and cases on the label. The values for the combination described here are as follows:

	Maximum permissible speed for riding with aluminium cases fitted to the motorcycle
	max 180 km/h
	Payload per aluminium case
	max 10 kg

## Topcase

– with aluminium topcase<sup>OA</sup>

## Opening topcase

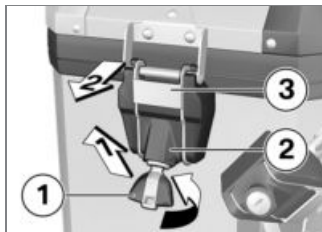

- Turn key **1** counter-clockwise.
- Push lock housing **2** upwards in order to release the catch **3**.
- Pull the latch **3** backwards and open the lid.

## Closing topcase

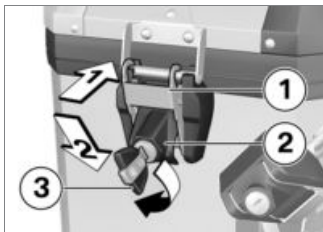

- Close the topcase lid.
- Set the latch **1** on the lid.
- Push lock housing **2** down, making sure that the latch toggle grips firmly in the lid.
- To lock the lock, turn key **3** clockwise and remove it.

## Removing the topcase

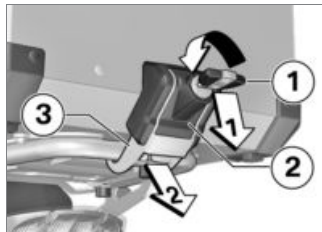

- Turn key **1** counter-clockwise.
- Push lock housing **2** downwards in order to release the catch **3**.
- Pull the latch **3** backwards.
- Pull the topcase to the rear and then lift it up to remove.

## Installing topcase

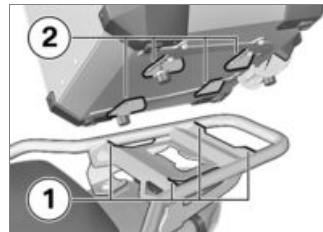

- Set the topcase on the topcase rack and push it forward in such a way that mounts on topcase rack **1** and on topcase **2** engage each other.

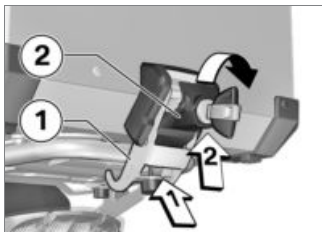



- Set the latch **1** on the topcase carrier.
- Push lock housing **2** up, making sure that the latch toggle grips firmly on the carrier.
- To secure the lock, turn the key clockwise and remove.

## Maximum payload and maximum speed

Note the maximum permissible payload and the speed limit for riding with topcase fitted, as stated on the label inside the topcase.

Contact your authorised BMW Motorrad dealer if you

cannot find your combination of vehicle and topcase on the label. The values for the combination described here are as follows:

	Maximum permissible speed for riding with aluminium topcase fitted to the motorcycle
	max 180 km/h
	Payload of aluminium topcase
	max 5 kg

## Navigation system

- with preparation for navigation system<sup>OE</sup>

## Securing navigation device



### NOTICE

Navigation preparation is suitable from BMW Motorrad Navigator IV. ◀



### NOTICE

The latching system of the Mount Cradle is not designed to protect against theft. Always remove the navigation system and stow it away safely as soon as you finish your ride. ◀

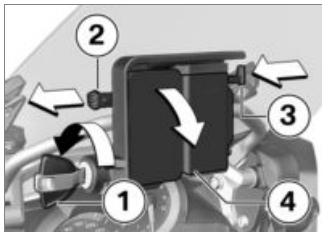

- Turn ignition key **1** counter-clockwise.
- Pull retainer **2** to the **left**.
- Press in lock **3**.
- » The Mount Cradle is released and cover **4** can be pivoted forward and removed.

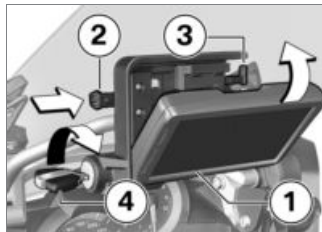

- Insert navigation device **1** at bottom and pivot it toward the rear.
- » The navigation device engages with an audible click.
- Push retainer **2** fully to the **right**.
- » Lock **3** is engaged.
- Turn ignition key **4** clockwise.
- » The navigation device is secured and the ignition key can be removed.

## Removing navigation device and installing cover



### ATTENTION

#### Dust and dirt on the Mount Cradle contacts

Damaged contacts

- Always reinstall the cover as soon as you finish your ride. ◀

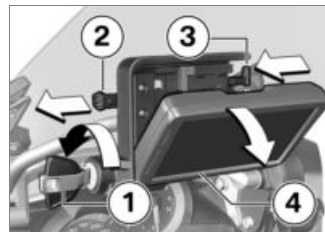

- Turn vehicle key **1** counter-clockwise.
- Pull retainer **2** fully to the **left**.
- » Lock **3** is disengaged.
- Push lock **3** fully to the **left**.

- » Navigation device **4** is unlocked.
- Tilt navigation device **4** and work it downward to remove.

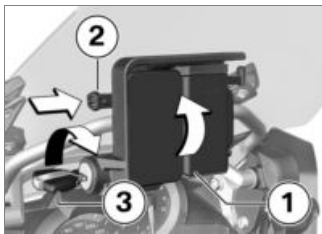

- Insert cover **1** at bottom and pivot it up.
- » The cover engages with an audible click.
- Push retainer **2** to the **right**.
- Turn vehicle key **3** clockwise.
- » Cover **1** is secured.

## Operating navigation system

### NOTICE

The description below is based on the BMW Motorrad Navigator V and the BMW Motorrad Navigator VI. The BMW Motorrad Navigator IV does not support all the options described here.◀

### NOTICE

Only the latest version of the BMW Motorrad communication system is supported. A software update of the BMW Motorrad communication system may be necessary. If this is the case, consult your authorised BMW Motorrad dealer.◀

If the BMW Motorrad Navigator is installed and the operating focus is switched to the Navigator ( 107), some of its functions

can be operated directly from the handlebars.

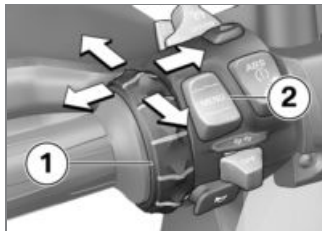

The navigation system is operated using the Multi-Controller **1** and the rocker button MENU **2**.

### Turn the Multi-Controller 1 up and down

In the compass and Medioplayer page: increase or decrease the volume of a Bluetooth-connected BMW Motorrad communication system.

In the BMW special menu: select menu item.

### **Tilt Multi-Controller 1 briefly to the left and right**

Switch between the main pages of the Navigator:

- Map view
- Compass
- Mediaplayer
- BMW special menu
- My Motorcycle page

### **Long tilt Multi-Controller 1 to the left and right**

Activate certain functions on the Navigator display. An arrow to the right or to the left above the corresponding button area on the display indicates a function that can be activated in this way.



Long-push to the right to activate this function.



Long-push to the left to activate this function.

### **Press rocker button MENU 2 down**

Switch operating focus to Pure Ride view.

In detail, the following functions can be controlled:

#### **Map view**

- Turn up: Zoom in.
- Turn down: Zoom out.

#### **Compass page**

- Turning increases or decreases the volume of a BMW Motorrad communication system connected via Bluetooth.

#### **BMW special menu**

- Speak: Repeat most recent navigation announcement.
- Waypoint: Save current location as a favourite.
- Home: Starts navigation to home address (greyed if no

home address has been defined).

- Mute: Switch automatic navigation announcements off or on (off: a crossed-out lips symbol appears in the top line of the display). "Speak" will still activate navigation announcements. All other acoustic outputs remain switched on.
- Switch off display: Deactivate the display.
- Dial home number: Dials the home phone number saved in the Navigator (not shown unless a communication system and a telephone are connected).
- Diversion: Activates the diversion function (not shown unless a route is active).
- Skip: Skips the next waypoint (not shown unless the route has waypoints).

## My Motorcycle

- Turn: Changes the number of data shown.
- Touch a data field on the display to open the menu for selecting data.
- The values available for selection depend on the optional extras installed on the vehicle.

## Medioplayer

- Push to the left and hold: Play preceding track.
- Push to the right and hold: Play next track.
- Turning increases or decreases the volume of a BMW Motorrad communication system connected via Bluetooth.

### NOTICE

The Medioplayer function is only available when a Bluetooth device complying with the A2DP

standard is used, for example a BMW Motorrad communication system. ◀

## Warnings and status messages



Warning and status messages from the motorcycle are indicated by a symbol **1** appearing at the top left in the map view.

### NOTICE

If a BMW Motorrad communication system is connected, warnings are accompanied by an acoustic signal. ◀

If there are two or more active warnings the number appears below the warning triangle.

Touching the warning triangle when more than one warning is active opens a list of all the warnings.

Additional information appears as soon as a message is selected.

### NOTICE

Detailed information cannot be displayed for all warnings. ◀

## Special functions

Integration of the BMW Motorrad Navigator can result in deviations from the descriptions in the operating instructions for the Navigator.

### Fuel reserve warning

The settings for the fuel gauge are not available as the reserve warning is transmitted from the vehicle to the Navigator. Touch

the message when it is active to view the locations of the nearest filling stations.

### **Date and time display**

The Navigator sends the time and date to the motorcycle. To accept the time in the TFT display, the GPS synchronisation function must also be activated in the menu *Settings, System settings, Date and time*.

### **Security settings**

The BMW Motorrad Navigator V and the BMW Motorrad Navigator VI can be secured against unauthorised use with a four-digit PIN (Garmin Lock). If this function is activated while the Navigator is installed in the vehicle and the ignition is switched on, you will be asked whether you want to add this vehicle to the list of secured vehicles. If you answer

"Yes" at this prompt, the Navigator saves the VIN of this vehicle in its internal memory.

A maximum of five VINs can be saved in this way.

It is then no longer necessary to enter the PIN when the Navigator is switched on by ignition ON on any of these vehicles.

If the Navigator is removed from the vehicle while switched on, a security prompt is issued asking for the PIN to be entered.

### **Screen brightness**

In the installed condition, the screen brightness is specified by the motorcycle. Manual input is not necessary.

Automatic setting can be switched off in the display settings for the Navigator if desired.



## Care

Care products .....	216
Washing the vehicle .....	216
Cleaning easily damaged components.....	217
Care of paintwork .....	218
Vehicle preservation .....	218
Laying up the motorcycle .....	219
Restoring motorcycle to use .....	219

## Care products

BMW Motorrad recommends that you use the cleaning and care products you can obtain from your authorised BMW Motorrad Retailer. The substances in BMW Care Products have been tested in laboratories and in practice; they provide optimised care and protection for the materials used in your vehicle.

### ATTENTION

#### Use of unsuitable cleaning and care products

Damage to vehicle parts

- Do not use solvents such as cellulose thinners, cold cleaners, fuel or the like, and do not use cleaning products that contain alcohol. ◀

### ATTENTION

#### Use of strongly acidic or strongly alkaline cleaning agents

Damage to vehicle parts

- Dilute in accordance with the dilution ratio stated on the packaging of the cleaning agent.
- Do not use strongly acidic or strongly alkaline cleaning agents. ◀

#### Washing the vehicle

BMW Motorrad recommends that you use BMW insect remover to soften and wash off insects and stubborn dirt on painted parts prior to washing the vehicle.

To prevent stains, do not wash the vehicle immediately after it has been exposed to strong sun-

light and do not wash it in the sun.

Make sure that the vehicle is washed frequently, especially during the winter months.

To remove road salt, clean the motorcycle with cold water immediately after every trip.

### WARNING

#### Wet brake discs and brake pads after vehicle wash, after riding through water and in rainy conditions

Diminished braking effect, risk of accident

- Apply the brakes in good time to allow the friction and heat to dry the brake discs and brake pads. ◀

### ATTENTION

#### Effect of road salt intensified by warm water

Corrosion

- Use only cold water to wash off road salt.◀



## ATTENTION

### Damage due to high water pressure from high pressure cleaners or steam cleaners

Corrosion or short circuit, damage to labels, seals, hydraulic brake system, electrical system and the motorcycle seat

- Exercise restraint when using a steam jet or high pressure cleaning equipment.◀



## NOTICE

Aluminium cases and topcases do not have a surface coating. Care in accordance with the instructions set out below will help ensure the best possible appearance:

Remove road salt and corrosive deposits by cleaning with cold

water immediately after every trip.◀

## Cleaning easily damaged components

### Plastics



## ATTENTION

### Use of unsuitable cleaning agents

Damage to plastic surfaces

- Do not use cleaning agents that contain alcohol, solvents or abrasives.
- Do not use insect-remover pads or cleaning pads with hard, scouring surfaces.◀

### Body panels

Clean trim panel components with water and BMW Motorrad solvent cleaner.

## Plastic windscreens and headlight lenses

Remove dirt and insects with a soft sponge and generous amounts of water.



## NOTICE

Soften stubborn dirt and insects by covering the affected areas with a wet cloth.◀



Clean with water and sponge only.



Do not use any chemical cleaning agents.

## TFT display

Clean the TFT display with warm water and washing-up liquid. Then dry it with a clean cloth, e.g. a paper towel.

## Chrome

Carefully clean chrome sections with a generous amount of water and motorcycle cleaner from the care series BMW Motorrad Care Products. This applies especially where road salt has been in use. For an additional treatment, use BMW Motorrad metal polish.

## Radiator

Clean the radiator regularly to prevent overheating of the engine due to inadequate cooling. For example, use a garden hose with low water pressure.



### ATTENTION

#### Bending of radiator fins

Damage to radiator fins

- Take care not to bend the radiator fins when cleaning.◀

## Rubber

Treat rubber components with water or BMW rubber-care products.



### ATTENTION

#### Application of silicone sprays to rubber seals

Damage to the rubber seals

- Do not use silicone sprays or care products that contain silicon.◀

## Care of paintwork

The long-term effects of materials that are damaging to paint can be prevented by regular vehicle washes, particularly if your vehicle is ridden in areas susceptible to high levels of air pollution or natural contamination, for example tree resin or pollen. Particularly aggressive materials, however, should be removed immediately, otherwise changes

to or discolouration of the paint can result. These include, for example, spilled fuel, oil, grease, brake fluid or bird excrement. For this, we recommend BMW Motorrad solvent cleaner followed by BMW Motorrad gloss polish for preservation. Contamination of the paint surface can be seen particularly clearly after a vehicle wash. These areas should be cleaned immediately using benzine or spirit, applied with a clean cloth or cotton pad. BMW Motorrad recommends that tar spots be removed using BMW tar remover. The paint should then be preserved in these areas.

## Vehicle preservation

If water no longer rolls off the paint, the paint must be preserved.

For paint preservation, BMW Motorrad recommends

the use of BMW Motorrad gloss polish or agents containing carnauba wax or synthetic wax.

## Laying up the motorcycle

- Clean the motorcycle.
- Fill the motorcycle's fuel tank with fuel.
- Removing battery (▶▶▶ 196).
- Spray the brake and clutch lever pivots and the main and side stand pivots with a suitable lubricant.
- Coat bright metal and chrome-plated parts with an acid-free grease (e.g. Vaseline).
- Stand the motorcycle in a dry room in such a way that there is no load on either wheel (preferably using the front-wheel and rear-wheel stands from BMW Motorrad).

## Restoring motorcycle to use

- Remove the protective wax coating.
- Clean the motorcycle.
- Installing battery (▶▶▶ 197).
- Comply with checklist (▶▶▶ 138).



## Technical data

Troubleshooting chart .....	222
Screw connections .....	225
Fuel.....	228
Engine oil .....	229
Engine .....	229
Clutch .....	230
Transmission .....	231
Rear-wheel drive.....	231
Frame .....	232
Chassis and suspension .....	232
Brakes .....	233
Wheels and tyres .....	234
Electrical system.....	236
Anti-theft alarm .....	237
Dimensions .....	238

Weights.....	240
Riding specifications .....	240

## Troubleshooting chart

The engine does not start.

Possible cause	Rectification
Kill switch activated	Set emergency-off switch (kill switch) to operating position.
Side stand extended and gear engaged	Retract the side stand.
Gear engaged and clutch not disengaged	Select neutral or pull the clutch lever.
No fuel in tank	Refuelling (▮▮▮▶ 149).
Battery flat	Charge battery when connected (▮▶▶ 195).
Overheating protection for starter motor has been activated. Starter motor can only be operated for a limited period of time.	Allow the starter motor to cool down for approx. 1 minute before using it again.



The Bluetooth connection is not established.

### Possible cause

The steps required for pairing were not carried out.

The communication system was not connected automatically despite successful pairing.

Too many Bluetooth devices are saved on the helmet.

There are other vehicles with Bluetooth-capable devices in the vicinity.

### Rectification

Check the necessary steps for pairing in the operating instructions for the communication system.

Switch off the helmet's communication system and reconnect it after a minute or two.

All pairing entries on the helmet are deleted (see the communication system operating instructions).

Avoid simultaneously pairing with more vehicles.

Bluetooth connection is interrupted.

### Possible cause

The Bluetooth connection to the mobile end device is interrupted.

The Bluetooth connection to the helmet is interrupted.

The volume in the helmet cannot be adjusted.

### Rectification

Switch off energy saving mode.

Switch off the helmet's communication system and reconnect it after a minute or two.

Switch off the helmet's communication system and reconnect it after a minute or two.

The telephone book is not displayed in the TFT display.

**Possible cause**

The phone book was not transmitted to the vehicle.

**Rectification**

When pairing the mobile end device, confirm transmission of the phone data (►► 121).

Active route guidance is not displayed in the TFT display.

**Possible cause**

Navigation from the BMW Motorrad Connected App was not transmitted.

**Rectification**

The BMW Motorrad Connected App is opened on the connected mobile end device prior to departure.

The route guidance cannot be started.

Secure the mobile device's data connection and check the map data on the mobile end device.





## Screw connections

Front wheel	Value	Valid
<b>Quick-release axle in the telescopic forks</b>		
M12 x 20	30 Nm	
<b>Fork bridge, lower, to slider tube</b>		
M8 x 35	<b>Tightening sequence: Tighten screws six times in alternate sequence</b>	
	19 Nm	
<b>Brake caliper on telescopic fork</b>		
M10 x 65	38 Nm	
<b>Wheel-speed sensor to fork leg</b>		
M6 x 16 Micro-encapsulated or medium-strength thread-locking compound	8 Nm	

<b>Rear wheel</b>	<b>Value</b>	<b>Valid</b>
<b>Rear wheel to wheel flange</b>		
M10 x 1.25 x 40	<b>Tightening sequence: tighten in diagonally opposite sequence</b>	
	60 Nm	
<b>Mirrors</b>	<b>Value</b>	<b>Valid</b>
<b>Mirror (locknut) to adapter</b>		
M10 x 1.25	Left-hand thread, 22 Nm	
<b>Adapter to clamping block</b>		
M10 x 14	25 Nm	
<b>Gearshift lever</b>	<b>Value</b>	<b>Valid</b>
<b>Peg to gearshift lever</b>		
M6 x 20 Micro-encapsulated	10 Nm	
<b>Footbrake lever</b>	<b>Value</b>	<b>Valid</b>
<b>Peg to footbrake lever</b>		
M6 x 20 Micro-encapsulated	10 Nm	

Footrests	Value	Valid
<b>Clamping block on footrest hinge</b>		
M8 x 25	20 Nm	
<b>Footrest on clamping block</b>		
M6 x 20 / M6 x 12	10 Nm	
Handlebars	Value	Valid
<b>Clamping block (handlebar clamp) to fork bridge</b>		
M8 x 35	<b>Tightening sequence: in the forward direction of travel, tighten until seated</b>	
	19 Nm	

## Fuel

Recommended fuel grade	 Super unleaded (maximum 15% ethanol, E15)  95 ROZ/RON 90 AKI
Alternative fuel grade	 Normal unleaded (with power loss) (maximum 15 % ethanol, E15)  91 ROZ/RON 87 AKI
Usable fuel capacity	approx. 30 l
Reserve fuel	approx. 4 l
Fuel consumption	4.75 l/100 km, following world-wide harmonised motorcycle test cycle (WMTC)
CO <sub>2</sub> emission	110 g/km, following world-wide harmonised motorcycle test cycle (WMTC)
– with power reduction <sup>OE</sup>	113 g/km, following world-wide harmonised motorcycle test cycle (WMTC)
Exhaust emissions standard	EU 4

## Engine oil

Engine oil, capacity	max 4 l, with filter change
Specification	SAE 5W-40, API SL / JASO MA2, Additives (e.g. molybdenum-based) are not permissible because they can attack coated components of the engine, BMW Motorrad recommends BMW Motorrad ADVANTEC Ultimate oil.
Engine oil, quantity for topping up	max 0.8 l, Difference between MIN and MAX

**BMW recommends** **ADVANTEC**  
ORIGINAL BMW ENGINE OIL

## Engine

Location of engine number	Crankcase, bottom right, below starter motor
Engine type	A74B12M
Engine design	Air/liquid-cooled, two-cylinder four-stroke opposed-twin engine with two overlying, spur-gear-driven camshafts, a counterbalance shaft and BMW ShiftCam variable intake camshaft control
Displacement	1254 cm <sup>3</sup>
Cylinder bore	102.5 mm
Piston stroke	76 mm

Compression ratio	12.5:1
Nominal output	100 kW, at engine speed: 7750 min <sup>-1</sup>
– with power reduction <sup>OE</sup>	79 kW, at engine speed: 7750 min <sup>-1</sup>
Torque	143 Nm, at engine speed: 6250 min <sup>-1</sup>
– with power reduction <sup>OE</sup>	140 Nm, at engine speed: 5000 min <sup>-1</sup>
Maximum engine speed	max 9000 min <sup>-1</sup>
Idle speed	1050 min <sup>-1</sup> , Engine at regular operating temperature

## Clutch

Clutch type	Multiplate oil-bath clutch, anti-hopping
-------------	--



## Transmission

Gearbox type	Claw-shift 6-speed gearbox with helical gearing
Gearbox transmission ratios	1.000 (60:60 teeth), Primary transmission ratio 1.650 (33:20 teeth), Transmission input ratio 2.438 (39:16 teeth), 1st gear 1.714 (36:21 teeth), 2nd gear 1.296 (35:27 teeth), 3rd gear 1.059 (36:34 teeth), 4th gear 0.943 (33:35 teeth), 5th gear 0.848 (28:33 teeth), 6th gear 1.061 (35:33 teeth), Transmission output ratio

## Rear-wheel drive

Type of final drive	Shaft drive with bevel gears
Type of rear suspension	Cast aluminium single swinging arm featuring BMW Motorrad Paralever
Gear ratio of final drive	2.91 (32/11 teeth)
Rear axle differential oil	SAE 70W-80 / Hypoid Axle G3

## Frame

Frame type	Tubular steel frame with supporting drive unit, steel pipe rear frames
Type plate location	Frame, front left at steering head bearing
Position of the Vehicle Identification Number	Frame, front right on steering head

## Chassis and suspension

### Front wheel

Type of front suspension	BMW Telelever, with anti-dive top fork bridge, trailing arm mounted on engine and telescopic forks, central spring strut supported by trailing arm and frame
Design of front wheel suspension	Central shock absorber with helical spring
– with Dynamic ESA <sup>OE</sup>	Central shock absorber complete with torsion spring and header tank, electrically adjustable decompression and compression-stage damping
Spring travel, front	210 mm, at wheel

## Rear wheel

Type of rear suspension	Cast aluminium single swinging arm featuring BMW Motorrad Paralever
Type of rear suspension	Central spring strut with coil spring, adjustable rebound stage damping and spring preload
– with Dynamic ESA <sup>OE</sup>	Central spring strut with coil spring and reservoir, electrically adjustable rebound-.stage and compression-stage damping, electrically adjustable spring preload
Spring travel at rear wheel	220 mm

## Brakes

### Front wheel

Type of front brake	Hydraulically operated twin disc brake with 4-piston radial brake calipers and floating brake discs
Brake-pad material, front	Sintered metal
Brake disc thickness, front	min 4 mm, Wear limit
Play of brake controls (Front brake)	1.6...2.1 mm, On the piston

**Rear wheel**

Type of rear brake	Hydraulically actuated disc brake with 2-piston floating caliper and fixed disc
Brake-pad material, rear	Sintered metal
Brake disc thickness, rear	min 4.5 mm, Wear limit
Blow-by clearance of the footbrake lever	1...1.5 mm, between the frame and the footbrake lever

**Wheels and tyres**

Recommended tyre sets	An overview of currently approved tyres is available from your authorised BMW Motorrad Retailer or on the Internet at <a href="http://bmw-motorrad.com">bmw-motorrad.com</a> .
Speed category, front/rear tyres	V, required at least: 240 km/h

**Front wheel**

Front wheel type	Cross-spoked wheel
Front wheel rim size	3.0" x 19"
Tyre designation, front	120/70 - R19
Load index, front tyre	min. 60
Permissible wheel load, front	max 190 kg
Permissible front-wheel imbalance	max 5 g

**Rear wheel**

Rear-wheel type	Cross-spoked wheel
Rear wheel rim size	4.50" x 17"
Tyre designation, rear	170/60 - R17
Load index, rear tyre	min. 72
Permissible wheel load, rear	max 320 kg
Permissible rear-wheel imbalance	max 45 g

**Tyre pressures**

Tyre pressure, front	2.5 bar, tyre cold
Tyre pressure, rear	2.9 bar, tyre cold

## Electrical system

Electrical rating of on-board sockets	max 5 A, total for all sockets
Fuse carrier 1	10 A, Slot 1: Instrument cluster, anti-theft alarm (DWA), ignition lock, diagnostic socket 7.5 A, Slot 2: Left multifunction switch, tyre pressure monitoring (RDC)
Fuse holder	50 A, Fuse 1: Voltage regulator

### Battery

Battery type	AGM battery (Absorbent Glass Mat)
– with HP battery <sup>OE</sup>	Lithium ion battery
Battery rated voltage	12 V
– with HP battery <sup>OE</sup>	12 V
Battery rated capacity	12 Ah
– with HP battery <sup>OE</sup>	10 Ah

### Spark plugs

Spark plugs, manufacturer and designation	NGK LMAR8AI-10
---	----------------

### Lighting

Bulb for high-beam headlight	LED
Bulbs for the low-beam headlight	LED
Bulb for parking light	LED

Bulb for tail light/brake light	LED
Bulbs for flashing turn indicators, front	RY10W / 12 V / 10 W
– with LED flashing turn indicator <sup>OE</sup>	LED
Bulbs for flashing turn indicators, rear	RY10W / 12 V / 10 W
– with LED flashing turn indicator <sup>OE</sup>	LED

## Anti-theft alarm

Activation time on arming	approx. 30 s
Alarm duration	approx. 26 s
Battery type	CR 123 A

## Dimensions

Length of motorcycle	2270 mm, over spray guard
Height of motorcycle	1460...1520 mm, over windscreen at DIN unladen weight
– with Style HP <sup>OE</sup>	1450...1510 mm, over windscreen at DIN unladen weight
– with Style HP <sup>OE</sup> – with two-up riding package <sup>OE</sup>	1460...1520 mm, over windscreen at DIN unladen weight
– with low-slung <sup>OE</sup>	1415...1475 mm, over windscreen at DIN unladen weight
Width of motorcycle	952 mm, with mirrors 980 mm, with hand protector
Front-seat height	890...910 mm, without rider at unladen weight
– with Style HP <sup>OE</sup>	880 mm, without rider at DIN unladen weight
– with Style HP <sup>OE</sup> – with Rallye seat <sup>OA</sup>	900 mm, without rider at DIN unladen weight
– with Style HP <sup>OE</sup> – with two-up riding package <sup>OE</sup>	890...910 mm, without rider at DIN unladen weight
– with low-slung <sup>OE</sup>	840...860 mm, without rider at DIN unladen weight



<ul style="list-style-type: none"> <li>– with low-slung<sup>OE</sup></li> <li>– with seat, black<sup>OE</sup></li> </ul>	820...840 mm, without rider at DIN unladen weight
Rider's inside-leg arc, heel to heel	1950...1990 mm, without rider at unladen weight
<ul style="list-style-type: none"> <li>– with Style HP<sup>OE</sup></li> <li>– with seat, low<sup>OA</sup></li> </ul>	1920 mm, without rider at unladen weight
<ul style="list-style-type: none"> <li>– with Style HP<sup>OE</sup></li> <li>– with Rallye seat<sup>OA</sup></li> </ul>	1960 mm, without rider at unladen weight
<ul style="list-style-type: none"> <li>– with Style HP<sup>OE</sup></li> <li>– with two-up riding package<sup>OE</sup></li> </ul>	1950...1990 mm, without rider at unladen weight
<ul style="list-style-type: none"> <li>– with low-slung<sup>OE</sup></li> </ul>	1850...1890 mm, without rider at unladen weight
<ul style="list-style-type: none"> <li>– with low-slung<sup>OE</sup></li> <li>– with seat, black<sup>OE</sup></li> </ul>	1810...1850 mm, without rider at unladen weight

## Weights

Vehicle kerb weight	268 kg, DIN unladen weight, ready for road 90 % load of fuel, without OE
Permissible gross weight	485 kg
Maximum payload	217 kg

## Riding specifications

Top speed	>200 km/h
– with aluminium case <sup>OA</sup>	180 km/h
– with aluminium topcase <sup>OA</sup>	180 km/h

## Service

BMW Motorrad Service .....	242
BMW Motorrad Service history ....	242
BMW Motorrad Mobility services .....	243
Maintenance work .....	243
BMW Service .....	243
Maintenance schedule .....	247
Maintenance confirmations .....	248
Service confirmations .....	262

## BMW Motorrad Service

BMW Motorrad has an extensive network of dealerships in place to look after you and your motorcycle in more than 100 countries. Authorised BMW Motorrad dealerships have the technical information and the technical know-how to carry out reliably all maintenance and repair work on your BMW.

You can locate your nearest authorised BMW Motorrad dealership by visiting our website:

**[bmw-motorrad.com](http://bmw-motorrad.com)**



### WARNING

#### **Maintenance and repair work not in compliance with correct procedure**

Risk of accident due to consequential damage

- BMW Motorrad recommends having work of this nature carried out on the vehicle by a

specialist workshop, preferably an authorised BMW Motorrad dealer. ◀

In order to help ensure that your BMW is always in optimum condition, BMW Motorrad recommends compliance with the maintenance intervals specified for your motorcycle. Have all maintenance and repair work that is carried out confirmed in the "Service" chapter in this manual. For generous treatment of claims submitted after the warranty period has expired, evidence of regular maintenance is essential.

Your authorised BMW Motorrad dealer can provide information on BMW services and the work undertaken as part of each service.

## BMW Motorrad Service history

### Entries

Maintenance work that has been carried out is entered in the proof of maintenance. The entries are like a Service Booklet and provide proof of regular maintenance.

If an entry is made in the electronic service booklet of the vehicle, service-relevant data is saved in the central IT systems of BMW AG, Munich.

If there is a change in vehicle owner, the data saved in the electronic service booklet can also be viewed by the new vehicle owner. A BMW Motorrad Retailer or a specialist workshop can also view data that is stored in the electronic service booklet.

## Objection

The vehicle owner can object to entries being made by the BMW Motorrad Retailer or a specialist workshop in the electronic service booklet along with the corresponding storage of data in the vehicle and transfer of data to the vehicle manufacturer for the period of time that they are the vehicle owner. In this instance, no entry is made in the electronic service booklet of the vehicle.

## BMW Motorrad Mobility services

As owner of a new BMW motorcycle, in circumstances in which assistance is required you can benefit from the protection afforded by the various BMW Motorrad mobility services (e.g. Mobile Service, breakdown service, vehicle recovery service).

Your authorised BMW Motorrad dealer will be happy provide information about the mobility services available to you.

## Maintenance work

### BMW Pre-delivery Check

Your authorised BMW Motorrad dealer conducts the BMW pre-delivery check before handing over the vehicle to you.

### BMW Running-in Check

The BMW running-in check has to be performed when the motorcycle has covered between 500 km and 1200 km.

## BMW Service

The BMW Service is carried out once a year. The scope of the service depends on the age of the vehicle and the mileage ridden. Your BMW Motorrad Retailer will confirm the service that

has been carried out for you and will enter the deadline for the next service.

For riders with a high mileage it may be necessary to have a service before the specified deadline. In this case, a corresponding maximum mileage is entered in the service confirmation. If this mileage is reached before the next service deadline, the service must be brought forward.

The Service Interval Indicator in the TFT display reminds you about one month or 1000 km in advance when the time for a service is approaching, on the basis of the programmed values.

To find out more about service, go to:

**[bmw-motorrad.com/service](http://bmw-motorrad.com/service)**

The scope of maintenance work required for your vehicle can be found in the following maintenance schedule:







## Maintenance schedule

- 1** BMW running-in check (including oil change)
- 2** BMW Service standard scope
- 3** Engine-oil change, with filter
- 4** Oil change in bevel gears rear
- 5** Check valve clearance
- 6** Replace all spark plugs
- 7** Replace air filter element
- 8** Check or replace air-filter element
- 9** Change brake fluid, entire system
  - a annually or every 10000 km (whichever comes first)
  - b every 2 years or every 20000 km (whichever comes first)
  - c if vehicle is used off-road, annually or every 10,000 km (whichever comes first)
  - d for the first time after one year, then every two years

## Maintenance confirmations

### BMW Service standard scope

The repair tasks in the BMW Service standard scope are listed below. The actual scope of maintenance work applicable for your vehicle may vary.

- Performing vehicle test with BMW Motorrad diagnostic system
- Visual inspection of clutch system
- Visual inspection of the brake lines, brake hoses and connections
- Check front brake pads and brake discs for wear
- Checking the brake fluid level of the front wheel brake
- Check rear brake pads and brake disc for wear
- Checking brake-fluid level, rear brakes
- Check coolant level
- Check the side stand's ease of movement
- Check the centre stand's ease of movement
- Check tyre pressure and tread depth
- Check the tension of the spokes, retighten if necessary
- Check lights and signalling system
- Function test, engine start suppression
- Final inspection and check for road safety
- Set service date and remaining distance with BMW Motorrad diagnosis system
- Check state of charge of the battery
- Confirm BMW service in on-board literature

## **BMW pre-delivery check**

carried out

at \_\_\_\_\_

\_\_\_\_\_  
Stamp, signature

## **BMW Running-in Check**

carried out

at \_\_\_\_\_

at km \_\_\_\_\_

Next service

at the latest

at \_\_\_\_\_

or, when reached earlier

at km \_\_\_\_\_

\_\_\_\_\_  
Stamp, signature

**BMW Service**

carried out

at \_\_\_\_\_

at km \_\_\_\_\_

Next service

at the latest

at \_\_\_\_\_

or, when reached earlier

at km \_\_\_\_\_

Work performed

BMW Service

Yes

No

Oil change, engine, with filter

Oil change in rear bevel gears

Checking valve clearance

Renewing all spark plugs

Renewing air cleaner insert

Checking or replacing air filter element  
(for maintenance)

Change brake fluid in entire system

Notes

-----

-----

-----

-----

-----

-----

-----

-----

\_\_\_\_\_

Stamp, signature

**BMW Service**

carried out

at \_\_\_\_\_

at km \_\_\_\_\_

Next service

at the latest

at \_\_\_\_\_

or, when reached earlier

at km \_\_\_\_\_

\_\_\_\_\_  
Stamp, signature

Work performed

BMW Service

Oil change, engine, with filter

Oil change in rear bevel gears

Checking valve clearance

Renewing all spark plugs

Renewing air cleaner insert

Checking or replacing air filter element

(for maintenance)

Change brake fluid in entire system

Yes      No

Notes

-----  
-----  
-----  
-----  
-----  
-----  
-----  
-----

**BMW Service**

carried out

at \_\_\_\_\_

at km \_\_\_\_\_

Next service

at the latest

at \_\_\_\_\_

or, when reached earlier

at km \_\_\_\_\_

Work performed

BMW Service

Yes

No

Oil change, engine, with filter

Oil change in rear bevel gears

Checking valve clearance

Renewing all spark plugs

Renewing air cleaner insert

Checking or replacing air filter element  
(for maintenance)

Change brake fluid in entire system

Notes

-----

-----

-----

-----

-----

-----

-----

-----

\_\_\_\_\_  
Stamp, signature

**BMW Service**

carried out

at \_\_\_\_\_

at km \_\_\_\_\_

Next service

at the latest

at \_\_\_\_\_

or, when reached earlier

at km \_\_\_\_\_

\_\_\_\_\_  
Stamp, signature

Work performed

BMW Service

Oil change, engine, with filter

Oil change in rear bevel gears

Checking valve clearance

Renewing all spark plugs

Renewing air cleaner insert

Checking or replacing air filter element

(for maintenance)

Change brake fluid in entire system

Yes      No

Notes

-----  
-----  
-----  
-----  
-----  
-----  
-----  
-----

**BMW Service**

carried out

at \_\_\_\_\_

at km \_\_\_\_\_

Next service

at the latest

at \_\_\_\_\_

or, when reached earlier

at km \_\_\_\_\_

Work performed

BMW Service

Yes

No

Oil change, engine, with filter

Oil change in rear bevel gears

Checking valve clearance

Renewing all spark plugs

Renewing air cleaner insert

Checking or replacing air filter element  
(for maintenance)

Change brake fluid in entire system

Notes

-----

-----

-----

-----

-----

-----

-----

-----

\_\_\_\_\_

Stamp, signature



**BMW Service**

carried out

at \_\_\_\_\_

at km \_\_\_\_\_

Next service

at the latest

at \_\_\_\_\_

or, when reached earlier

at km \_\_\_\_\_

\_\_\_\_\_  
Stamp, signature

Work performed

BMW Service

Oil change, engine, with filter

Oil change in rear bevel gears

Checking valve clearance

Renewing all spark plugs

Renewing air cleaner insert

Checking or replacing air filter element

(for maintenance)

Change brake fluid in entire system

Yes      No

Notes

-----  
-----  
-----  
-----  
-----  
-----  
-----  
-----

**BMW Service**

carried out

at \_\_\_\_\_

at km \_\_\_\_\_

Next service

at the latest

at \_\_\_\_\_

or, when reached earlier

at km \_\_\_\_\_

Work performed

BMW Service

Oil change, engine, with filter

Oil change in rear bevel gears

Checking valve clearance

Renewing all spark plugs

Renewing air cleaner insert

Checking or replacing air filter element  
(for maintenance)

Change brake fluid in entire system

Yes

No

Notes

-----

-----

-----

-----

-----

-----

-----

-----

\_\_\_\_\_  
Stamp, signature

**BMW Service**

carried out

at \_\_\_\_\_

at km \_\_\_\_\_

Next service

at the latest

at \_\_\_\_\_

or, when reached earlier

at km \_\_\_\_\_

\_\_\_\_\_  
Stamp, signature

Work performed

BMW Service

Oil change, engine, with filter

Oil change in rear bevel gears

Checking valve clearance

Renewing all spark plugs

Renewing air cleaner insert

Checking or replacing air filter element

(for maintenance)

Change brake fluid in entire system

Yes      No

Notes

-----  
-----  
-----  
-----  
-----  
-----  
-----  
-----  
-----

**BMW Service**

carried out

at \_\_\_\_\_

at km \_\_\_\_\_

Next service

at the latest

at \_\_\_\_\_

or, when reached earlier

at km \_\_\_\_\_

Work performed

BMW Service

Yes

No

Oil change, engine, with filter

Oil change in rear bevel gears

Checking valve clearance

Renewing all spark plugs

Renewing air cleaner insert

Checking or replacing air filter element  
(for maintenance)

Change brake fluid in entire system

Notes

-----

-----

-----

-----

-----

-----

-----

-----

\_\_\_\_\_  
Stamp, signature

**BMW Service**

carried out

at \_\_\_\_\_

at km \_\_\_\_\_

Next service

at the latest

at \_\_\_\_\_

or, when reached earlier

at km \_\_\_\_\_

\_\_\_\_\_  
Stamp, signature

Work performed

BMW Service

Oil change, engine, with filter

Oil change in rear bevel gears

Checking valve clearance

Renewing all spark plugs

Renewing air cleaner insert

Checking or replacing air filter element

(for maintenance)

Change brake fluid in entire system

Yes      No

Notes

-----  
-----  
-----  
-----  
-----  
-----  
-----  
-----

**BMW Service**

carried out

at \_\_\_\_\_

at km \_\_\_\_\_

Next service

at the latest

at \_\_\_\_\_

or, when reached earlier

at km \_\_\_\_\_

Work performed

BMW Service

Yes

No

Oil change, engine, with filter

Oil change in rear bevel gears

Checking valve clearance

Renewing all spark plugs

Renewing air cleaner insert

Checking or replacing air filter element  
(for maintenance)

Change brake fluid in entire system

Notes

-----

-----

-----

-----

-----

-----

-----

-----

\_\_\_\_\_  
Stamp, signature

**BMW Service**

carried out

at \_\_\_\_\_

at km \_\_\_\_\_

Next service

at the latest

at \_\_\_\_\_

or, when reached earlier

at km \_\_\_\_\_

\_\_\_\_\_  
Stamp, signature

## Work performed

BMW Service

Yes

No

Oil change, engine, with filter

Oil change in rear bevel gears

Checking valve clearance

Renewing all spark plugs

Renewing air cleaner insert

Checking or replacing air filter element  
(for maintenance)

Change brake fluid in entire system

## Notes

-----

-----

-----

-----

-----

-----

-----

-----









## Appendix

Certificate for electronic immobiliser .....	266
Certificate for Keyless Ride .....	268
Certificate for tyre pressure control (RDC) .....	270
Certificate for TFT instrument cluster .....	271

## FCC Approval

### Ring aerial in the ignition switch



To verify the authorization of the ignition key, the electronic immobilizer exchanges information with the ignition key via the ring aerial.

This device complies with Part 15 of the FCC rules. Operation is subject to the following two conditions:

- (1) This device may not cause harmful interference, and
- (2) this device must accept any interference received, including interference that may cause undesired operation.



Any changes or modifications not expressly approved by the party responsible for compliance could void the user's authority to operate the equipment. ◀

## Approbation de la FCC

### Antenne annulaire présente dans le commutateur d'allumage



Pour vérifier l'autorisation de la clé de contact, le système d'immobilisation électronique échange des

informations avec la clé de contact via l'antenne annulaire.

Le présent dispositif est conforme à la partie 15 des règles de la FCC. Son utilisation est soumise aux deux conditions suivantes :

- (1) Le dispositif ne doit pas produire d'interférences nuisibles, et
- (2) le dispositif doit pouvoir accepter toutes les interférences extérieures, y compris celles qui pourraient provoquer une activation inopportune.



Toute modification qui n'aurait pas été approuvée expressément par l'organisme responsable de l'homologation peut annuler l'autorisation accordée à l'utilisateur pour utiliser le dispositif. ◀

## Certifications

---

### BMW Keyless Ride ID Device



#### USA, Canada

Product name: BMW Keyless Ride ID Device  
FCC ID: YGOHUF5750  
IC: 4008C-HUF5750

#### Canada:

Operation is subject to the following two conditions:

- (1) This device may not cause harmful interference, and
- (2) this device must accept any interference received, including interference that may cause undesired operation.

#### USA:

This device complies with Part 15 of the FCC rules. Operation is subject to the following two conditions:

- (1) This device may not cause harmful interference, and
- (2) this device must accept any interference received, including interference that may cause undesired operation.



Any changes or modifications not expressly approved by the party responsible for compliance could void the user's authority to operate the equipment.

# Declaration Of Conformity

---

We declare under our responsibility that the product

## **BMW Keyless Ride ID Device (Model: HUF5750)**

complies with the appropriate essential requirements of the article 3 of the R&TIE and the other relevant provisions, when used for its intended purpose. Applied Standards:

1. Health and safety requirements contained in article 3 (1) a)
  - EN 60950-1:2006+A11:2009+A1:2010+A12:2011; Information technology equipment- Safety
2. Protection requirements with respect to electromagnetic compatibility article 3 (1) b)
  - EN 301 489-1 (V1.9.2, 09/2011), Electromagnetic compatibility and radio spectrum matters (ERM); Electromagnetic compatibility (EMC) standard for radio equipment and services; Part 1: Common technical requirements
  - EN 301 489-3 (V1.4.1, 08/2002) Electromagnetic compatibility and radio spectrum matters (ERM); Electromagnetic compatibility (EMC) standard for radio equipment and services; Part 3: Specific conditions for short range devices (SRD) operating on frequencies between 9 kHz and 40 GHz
3. Means of the efficient use of the radio frequency spectrum article 3 (2)
  - EN 300 220-1 & -2 (V2.4.1, 05/2012), electromagnetic compatibility and radio spectrum matters (ERM); Short range devices (SRD); Radio equipment to be used in the 25 MHz to 1000 MHz frequency range with power levels ranging up to 500 mW;  
Part 1: Technical characteristics and test methods.  
Part 2: Harmonized EN covering essential requirements under article 3.2 of the R&TIE directive

The product is labeled with the CE marking: 

Velbert, October 15<sup>th</sup>, 2013

---

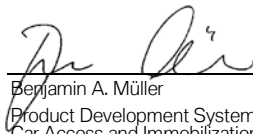

---

Benjamin A. Müller  
Product Development Systems  
Car Access and Immobilization – Electronics  
Huf Hüsbeck & Fürst GmbH & Co. KG  
Steeger Straße 17, D-42551 Velbert

## Certification Tire Pressure Control (TPC)

---

FCC ID: MRXBC54MA4  
IC: 2546A-BC54MA4

FCC ID: MRXBC5A4  
IC: 2546A-BC5A4

This device complies with Part 15 of the FCC Rules and with Industry Canada license-exempt RSS standard(s).

Operation is subject to the following two conditions:

- (1) This device may not cause harmful interference, and
- (2) This device must accept any interference received, including interference that may cause undesired operation.

Le présent appareil est conforme aux CNR d'Industrie Canada applicables aux appareils radio exempts de licence. L'exploitation est autorisée aux deux conditions suivantes:

- (1) l'appareil ne doit pas produire de brouillage, et
- (2) l'utilisateur de l'appareil doit accepter tout brouillage radioélectrique subi, même si le brouillage est susceptible d'en compromettre le fonctionnement.

**WARNING:** Changes or modifications not expressly approved by the party responsible for compliance could void the user's authority to operate the equipment. The term "IC:" before the radio certification number only signifies that Industry Canada technical specifications were met.



# Declaration of Conformity

## Radio equipment TFT instrument cluster

For all Countries without EU

### Technical information

BT operating frq. Range: 2402 – 2480 MHz

BT version: 4.2 (no BTLE)

BT output power: < 4 dBm

WLAN operating frq. Range: 2412 – 2462 MHz

WLAN standards: IEEE 802.11 b/g/n

WLAN output power: < 20 dBm

### Manufacturer and Address

Manufacturer:

Robert Bosch Car Multimedia GmbH

Adress: Robert Bosch Str. 200,

31139 Hildesheim, GERMANY

### Turkey

Robert Bosch Car Multimedia GmbH, ICC6.5in

tipi telsiz sisteminin 2014/53/EU

nolu yönetmeliğe uygun olduğunu beyan eder.

AB Uygunluk Beyanı'nın tam metni, aşağıdaki

internet adresinden görülebilir: [http://cert.bosch-](http://cert.bosch-carmultimedia.net)

[carmultimedia.net](http://cert.bosch-carmultimedia.net)

### Brazil

Este equipamento opera em caráter secundário,

isto é, não tem direito a proteção contra

interferência prejudicial, mesmo de estações do

mesmo tipo, e não pode causar interferência a

sistemas operando em caráter primário.

## **Canada**

This device complies with Industry Canada's licence-exempt RSSs and part 15 of the FCC Rules. Operation is subject to the following two conditions:

(1) this device may not cause interference, and  
(2) this device must accept any interference, including interference that may cause undesired operation of the device.

Changes or modifications not expressly approved by the party responsible for compliance could void the user's authority to operate the equipment.

Le présent appareil est conforme aux CNR d'Industrie Canada applicables aux appareils radio exempts de licence. L'exploitation est autorisée aux deux conditions suivantes : (1) l'appareil ne doit pas produire de brouillage, et (2) l'appareil doit accepter tout brouillage radioélectrique subi, même si le brouillage est susceptible d'en compromettre le fonctionnement.

## **Mexico**

La operación de este equipo está sujeta a las siguientes dos condiciones:

(1) es posible que este equipo o dispositivo no cause interferencia perjudicial y  
(2) este equipo o dispositivo debe aceptar cualquier interferencia, incluyendo la que pueda causar su operación no deseada.

## **Taiwan, Republic of**

根據 NCC 低功率電波輻射性電機管理辦法 規定：  
第十二條

經型式認證合格之低功率射頻電機，非經許可，公司、商號或使用者均不得擅自變更頻率、加大功率或變更原設計之特性及功能。

### 第十四條

低功率射頻電機之使用不得影響飛航安全及干擾合法通信；經發現有干擾現象時，應立即停用，並改善至無干擾時方得繼續使用。

前項合法通信，

指依電信法規定作業之無線電通信。

低功率射頻電機須忍受合法通信或工業、科學及醫療用電波輻射性電機設備之干擾。

## **Thailand**

เครื่องโทรคมนาคมและอุปกรณ์นี้

มีความสอดคล้องตามข้อกำหนดของ กทช.

(This telecommunication equipments is in compliance with NTC requirements)

## **United States (USA)**

This device complies with Industry Canada's licence-exempt RSSs and part 15 of the FCC Rules. Operation is subject to the following two conditions:

(1) this device may not cause interference, and  
(2) this device must accept any interference, including interference that may cause undesired operation of the device.

Changes or modifications not expressly approved by the party responsible for compliance could void the user's authority to operate the equipment.

Le présent appareil est conforme aux CNR d'Industrie Canada applicables aux appareils radio exempts de licence. L'exploitation est autorisée aux deux conditions suivantes : (1) l'appareil ne doit pas produire de brouillage, et (2) l'appareil doit accepter tout brouillage radioélectrique subi, même si le brouillage est susceptible d'en compromettre le fonctionnement.

## **Korea**

적합성평가에 관한 고시

R-CMM-RBR-ICC651N

상호 : Robert Bosch Car Multimedia

GmbH 모델명 : ICC6.5in

기자재명칭 : 특정소출력 무선기기

(무선데이터통신시스템용 무선기기)

제조사 및 제조국가 : Robert Bosch Car

Multimedia GmbH / 포르투갈

제조년월 : 제조년월로 표기

이 기기는 업무용 환경에서 사용할 목적으로 적합성평가를 받은 기기로서 가정용 환경에서 사용하는 경우 전파간섭의 우려가 있습니다.

- A**  
Abbreviations and symbols, 6  
ABS  
  Control, 23  
  Engineering details, 156  
  operate, 76  
  Self-diagnosis, 140  
  Status indicators, 54  
Accessories  
  General instructions, 204  
Actuality, 8  
Air filter  
  Position on the motorcycle, 21  
  Replace insert, 189  
Ambient temperature  
  Outside temperature  
    warning, 43  
  Reading, 43  
Anti-theft alarm  
  Indicator light, 26  
  operate, 92  
  Technical data, 237  
  Warning, 46
- ASC  
  Control, 23  
  Engineering details, 159  
  Indicator and warning light , 55  
  operate, 78  
  Self-diagnosis, 141
- B**  
Battery  
  Charge battery when  
    connected, 195  
  Charging battery when  
    disconnected, 196  
  Indicator light for vehicle  
    voltage, 44  
    install, 197  
  Maintenance instructions, 194  
  Removal, 196  
  Technical data, 236  
Bluetooth, 112  
  Pairing, 112
- Brake fluid  
  Checking fluid level, front, 178  
  Checking fluid level, rear, 179  
  Reservoir, front, 21  
  Reservoir, rear, 21  
Brake pads  
  Checking front, 176  
  Checking rear, 177  
  Running in, 143  
Brakes  
  ABS Pro in detail, 158  
  ABS Pro depending on riding  
    mode, 146  
  Adjust hand lever, 127  
  Adjusting footbrake lever, 129  
  Checking function, 176  
  Dynamic Brake Control  
    depending on riding mode, 146  
  Safety information, 145  
  Technical data, 233
- C**  
Care  
  Chrome, 218  
  Paintwork preservation, 218

- Cases
  - operate, 205
- Check control
  - Dialogue, 33
  - Reading, 33
- Checklist, 138
- Clock
  - adjust, 111
- Clutch
  - Adjust hand lever, 126
  - Checking function, 180
  - Technical data, 230
- Coding plug
  - install, 86
- Coolant
  - Checking fill level, 180
  - Indicator light for excess temperature, 47
  - Topping up, 181
- Cruise-control system
  - operate, 87
- D**
- Damping
  - Adjuster, rear, 19
- Daytime riding lights
  - Automatic daytime riding light, 73
  - Manual daytime riding light, 73
- D-ESA
  - Control, 23
  - operate, 79
- Diagnostic connector
  - Loosen, 200
  - secure, 200
- Dimensions
  - Technical data, 238
- DTC
  - Engineering details, 159
  - Indicator and warning light , 55
  - operate, 78
  - Self-diagnosis, 141
- Dynamic Brake Control, 164
  - Engineering details, 164
- E**
- Electrics
  - Technical data, 236
- Emergency call
  - Automatically in the event of a light fall, 70
  - Automatically in the event of a severe fall, 71
  - Information, 12
  - Language, 69
  - manual, 69
  - operate, 69
- Emergency off switch (kill switch), 25
  - Operation, 68
- Emissions warning light, 48
- Engine
  - Indicator light for engine control, 49
  - Indicator light for engine electronics, 48
  - Malfunction indicator lamp, 48
  - starting, 139
  - Technical data, 229
- Engine oil
  - Checking fill level, 174
  - Electronic oil-level check, 47
  - Filler neck, 21

- Fill-level indicator, 21
- Indicator light for engine oil level, 47
- Technical data, 229
- Topping up, 175
- Equipment, 7
- F**
- Frame
  - Technical data, 232
- Front-wheel stand
  - install, 173
- Fuel
  - Filler neck, 19
  - Fuel grade, 148
  - Refuelling, 149
  - refuelling with Keyless Ride, 150, 151
  - Technical data, 228
- Fuel reserve
  - Range, 110
  - Warning, 57
- Fuses
  - Replacing, 198

- G**
- General views
  - Indicator and warning lights, 28
  - Instrument panel, 26
  - Left multifunction switch, 23
  - Left side of vehicle, 19
  - My vehicle, 115
  - My Vehicle, 115
  - Right multifunction switch, 25
  - Right side of vehicle, 21
  - TFT display, 30, 32
  - Underneath the seat, 22

- H**
- Handlebars
  - adjust, 132
- Hazard warning flashers
  - Control, 23, 25
  - operate, 74
- Headlight
  - Beam throw, 125
- Headlight courtesy delay
  - feature, 62
- Heated handlebar grips
  - Control, 25
  - operate, 95

- Hill Start Control, 89, 168
  - cannot be activated, 58
  - Engineering details, 168
  - Indicator and warning lights, 58
  - operate, 89
  - switching on/off, 90
- Hill Start Control Pro
  - adjust, 92
  - Engineering details, 168
  - operate, 90
- Horn, 23

- I**
- Ignition
  - switching off, 63
  - switching on, 62
- Immobiliser
  - Emergency key, 66
  - Reserve key, 63
- Instrument panel
  - Ambient-light brightness sensor, 26
  - Overview, 26

- J**
- Jump-start, 193

## **K**

### Keyless Ride

- Battery of the radio-operated key is empty or loss of the radio-operated key, 66
- Electronic immobiliser EWS, 66
- Fuel filler cap, unlocking, 150, 151
- Lock the handlebars, 64
- Switching off ignition, 65
- Switching on ignition, 65
- Warning, 43, 44

### Keys, 62, 64

## **L**

### Lighting

- Replacing LED auxiliary headlights, 193
- Replacing rear light, 193
- Replacing the LED headlight, 193
- Technical data, 236
- Turn indicators, 191
- Warning for faulty bulb, 45

## Lights

- Automatic daytime riding light, 73
  - Control, 23
  - Headlight flasher, operating, 71
  - High-beam headlight, operating, 71
  - Low-beam headlight, 71
  - Manual daytime riding light, 73
  - Operating additional headlights, 72
  - Parking lights, 72
  - Side light, 71
- ### Lowered suspension
- Restrictions, 136
- ### Luggage
- Instructions for loading, 136

## **M**

### Maintenance

- Maintenance schedule, 247
- Maintenance confirmations, 248
- Maintenance intervals, 243

### Media

- operate, 120

## Menu

- Call up, 106

### Mirrors

- adjust, 124
- Adjusting mirror arm, 125
- Adjusting mirrors, 124

### Mobility services, 243

### Motorcycle

- Care, 215
- Cleaning, 215
- Lashing, 152
- Laying up, 219
- Parking, 147

### Multifunction switch

- General view, left side, 23
- General view, right side, 25

## **N**

### Navigation

- operate, 118

## **O**

### Off-roading, 143

### On-board computer, 115

### On-board voltage

- Warning, 44

Operating focus  
change, 107

**P**

Pairing, 112

Parking, 147

Parking light, 72

Phone

operate, 120

Power socket

Notes on use, 204

Position on the vehicle, 21

Pre-Ride-Check, 140

Pure Ride

Overview, 30

**R**

RDC

Adhesive label for rim, 183

Engineering details, 165

Warnings, 50

Rear-wheel drive

Technical data, 231

Refuelling, 149

Fuel grade, 148

with Keyless Ride, 150, 151

Remote control

Replacing battery, 67

Rev. counter, 26

Engine speed display, 109

Rider info status line

adjust, 108, 109

Rider's Manual

Position on the vehicle, 22

Riding mode

adjust, 82

Control, 25

Engineering details, 162

Setting PRO riding mode, 85

Riding specifications

Technical data, 240

Running gear

Technical data, 232

Running in, 142

**S**

Safety instructions

for brakes, 145

For riding, 136

Seat

Position of the height  
adjustment, 22

Seats

Adjusting the seat height, 97

Lock, 19

Removing and installing, 96

Service, 242

Service history, 242

Service-due indicator, 59

Shift assistant

Engineering details, 167

Gear not trained, 58

Riding, 144

Shift lever

adjust, 130

ShiftCam, 170

Engineering details, 170

Shifting gear

Recommendation to  
upshift, 110

Spark plugs

Technical data, 236

Speed Limit Info

Switching on or off, 109

Speedometer, 26



Spring preload  
adjust, 132  
Adjuster, rear, 21

Starting, 139  
Control, 25

Steering lock  
Locking, 62

## T

Technical data  
Anti-theft alarm, 237  
Battery, 236  
Brakes, 233  
Bulbs, 236  
Chassis and suspension, 232  
Clutch, 230  
Dimensions, 238  
Electrical system, 236  
Engine, 229  
Engine oil, 229  
Frame, 232  
Fuel, 228  
General instructions, 7  
Rear-wheel drive, 231  
Riding specifications, 240

Spark plugs, 236  
Standards, 7  
Transmission, 231  
Weights, 240  
Wheels and tyres, 234

Telltale lights, 26  
Overview, 28

TFT display, 26  
Control, 23  
operate, 106, 107, 108  
Overview, 30, 32  
Select display, 103

Threaded fasteners, 225

Toolkit  
Position on the vehicle, 22

Topcase  
operate, 207

Torques, 225

Traction control  
ASC, 159  
DTC, 159

Transmission  
Technical data, 231

Troubleshooting chart, 222

Turn indicators  
Control, 23  
Control, right, 25  
operate, 75

Type plate  
Position on the vehicle, 21

Tyre pressure monitoring RDC  
Reading, 49

Tyres  
Check filling pressure, 181  
Check tread depth, 182  
Checking tread depth, 182  
Pressures, 235  
Running in, 143  
Table of tyre pressures, 22  
Technical data, 234  
Top speed, 137

## V

Value  
Reading, 33

Vehicle  
Put into operation, 219

Vehicle Identification Number  
Position on the vehicle, 21

**W**

Warning lights, 26

Overview, 28

**Warnings**

ABS, 54

Anti-theft alarm, 46

ASC, 55

Bulb faulty, 45

Coolant temperature, 47

DTC, 55

Engine control unit, 49

Engine electronics, 48

Engine oil level, 47

Fuel reserve, 57

Gear not trained, 58

Hill Start Control, 58

Malfunction indicator lamp, 48

Mode of presentation, 33

My vehicle, 115

My Vehicle, 115

On-board voltage, 44

Outside temperature

warning, 43

RDC, 50

Warnings, overview, 36

**Weights**

Payload table, 22

Technical data, 240

**Wheels**

Change of size, 182

Check spokes, 182

Check wheel rims, 182

Checking rims, 182

Installing front wheel, 185

Installing the rear wheel, 188

Removing front wheel, 183

Technical data, 234

**Windscreen**

adjust, 126

Adjusting element, 21



Details described or illustrated in this booklet may differ from the vehicle's actual specification as purchased, the accessories fitted or the national-market specification. No claims will be entertained as a result of such discrepancies.

Dimensions, weights, fuel consumption and performance data are quoted to the customary tolerances.

The right to modify designs, equipment and accessories is reserved.

Errors and omissions excepted.

© 2019 Bayerische Motoren Werke Aktiengesellschaft  
80788 Munich, Germany  
Not to be reproduced by any means whatsoever, wholly or in part, without the written permission of BMW Motorrad, After Sales.

Original rider's manual, printed in Germany.

