


Description of symbols



Refers to a section within a chapter that contains important information and safety notes  that should always be observed.



Indicates that the section is continued on the next page.



Indicates the end of a section.



Indicates situations in which the vehicle must be stopped as quickly as possible.



The symbol indicates a registered trademark. However, the absence of this symbol does not constitute a waiver of the rights concerning any term.



Symbols like these refer you to warnings within the same section or on a given page. They draw your attention to possible risks of accident or injury and explain how they can be avoided.

Cross reference to potential risks of damage to property in the same section or on the page specified.



DANGER

Texts with this symbol indicate dangerous situations which will lead to fatal or severe injuries if you do not observe the warning.



WARNING

Texts with this symbol indicate dangerous situations which could lead to fatal or severe injuries if you do not observe the warning.



CAUTION

Texts with this symbol indicate dangerous situations which could lead to slight or severe injuries if you do not observe the warning.



NOTICE

Texts with this symbol indicate situations which could cause vehicle damage if you do not observe the warning.



Texts with this symbol contain additional information on the protection of the environment.



Texts with this symbol contain additional information.

Thank you for choosing Volkswagen

By purchasing this Volkswagen, you have become the owner of a vehicle fitted with the most up-to-date technology and a multitude of convenience functions for your use and enjoyment.

Before using your vehicle for the first time, please read and observe the information in this owner's manual. It will quickly help you to become familiar with your vehicle and all of its functions as well as making you aware of dangers to yourself and others and of how these dangers can be avoided.

If you have any further questions about your vehicle, or if you think that the vehicle wallet has not covered everything, please get in touch with your Volkswagen dealership. They will always be happy to deal with your questions, suggestions or problems.

We hope you enjoy driving your new vehicle. Happy motoring.

Volkswagen AG



DANGER

Please observe important safety notes on the front passenger front airbag → *Basic information on fitting and using child seats* .

About this owner's manual

- This owner's manual is valid for all models and versions of the Polo.
- An [alphabetical index](#) is included at the end of this manual.
- A [list of abbreviations](#) at the end of the manual explains the abbreviations used.
- [Directions and positions](#) such as left, right, front and rear are normally relative to the vehicle's direction of travel, unless otherwise indicated.
- [Illustrations](#) help with orientation and should be regarded as a general guide.
- This owner's manual was written for left-hand drive vehicles. In [right-hand drive vehicles](#) the controls may sometimes be different to those displayed in illustrations or described in the text → [Overview of the driver side](#) .
- Any technical changes that may be made to the vehicle after publication of this booklet are contained in a [supplement](#) that is included with the vehicle wallet.

All equipment and models are described without indicating whether the equipment is optional or specific to the model type. This means that your vehicle may not have some of the equipment described, or it may only be available in certain markets. The scope of equipment fitted in your vehicle can be found in the sales documentation and you can contact your Volkswagen dealership for further information.

All data in this owner's manual correspond to the information available at the time of going to print. Because the vehicle is constantly being developed and further improved, there may be differences between your vehicle and the data in this owner's manual. No discrepancy in data, illustrations or descriptions shall form the basis for any legal claim.

Please ensure that the complete vehicle wallet is always in the vehicle if you lend or sell the vehicle to someone else.

Standard booklets in the vehicle wallet:

- Service schedule
- Owner's manual

Additional booklets in the vehicle wallet (optional):

- Supplements
- Radio/navigation system
- Provision for a mobile telephone
- *Other supplements*

Overview of the vehicle

Exterior views

Side view

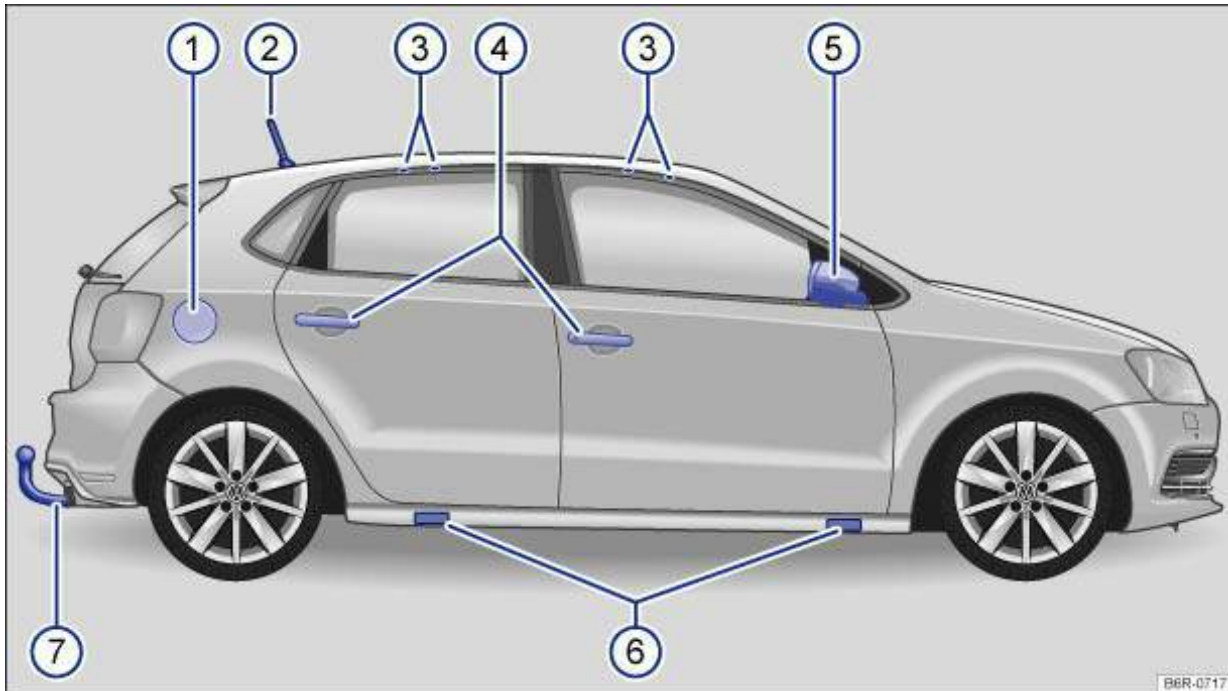


Fig. 1 Overview of the right side of the vehicle. Positions ③, ④, ⑤ and ⑥ are also at the same position on the left side of the vehicle

Key to → Fig. 1:

- ① Tank flap → *Filling the tank*
- ② Roof aerial → *Consumer information*
- ③ Attachment points for the mounts → *Roof carrier*
- ④ Door release lever → *Central locking system* → *Manual opening and closing*
- ⑤ Exterior mirrors → *Mirrors*
- ⑥ Jacking points → *Changing a wheel*
- ⑦ Towing bracket → *Towing a trailer*

Front view

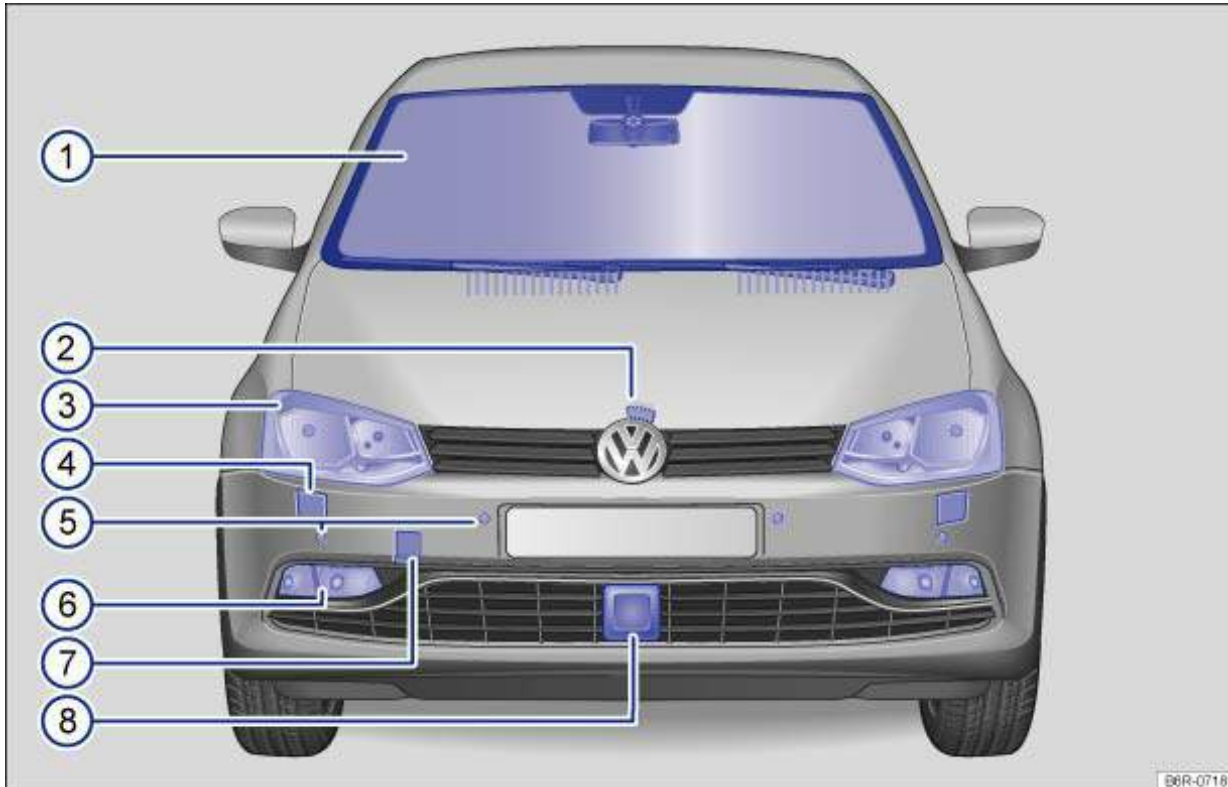


Fig. 2 Overview of the front of the vehicle

Key to → Fig. 2:

- ① Windscreen with:
 - Windscreen wipers → *Windscreen wipers and washer*
 - Interior mirror → *Mirrors*
 - Rain/light sensor on the mirror base → *Windscreen wipers and washer*
 - Automatic headlight control → *Lights*
- ② Bonnet release lever → *Preparation for working in the engine compartment*
- ③ Headlights (on both left and right) → *Lights* → *Changing a bulb*
- ④ Headlight washer system (on both left and right) → *Windscreen wipers and washer*
- ⑤ Front ParkPilot sensors (on both left and right) → *ParkPilot*
- ⑥ Fog lights and static cornering light (on both left and right) → *Lights* → *Changing a bulb*
- ⑦ Mounting for the front towing eye behind a cover → *Tow-starting and towing*
- ⑧ Radar sensor for:
 - Adaptive Cruise Control (ACC) → *Adaptive Cruise Control (ACC)*
 - Area monitoring system (Front Assist) → *Area monitoring system (Front Assist)*

Rear view

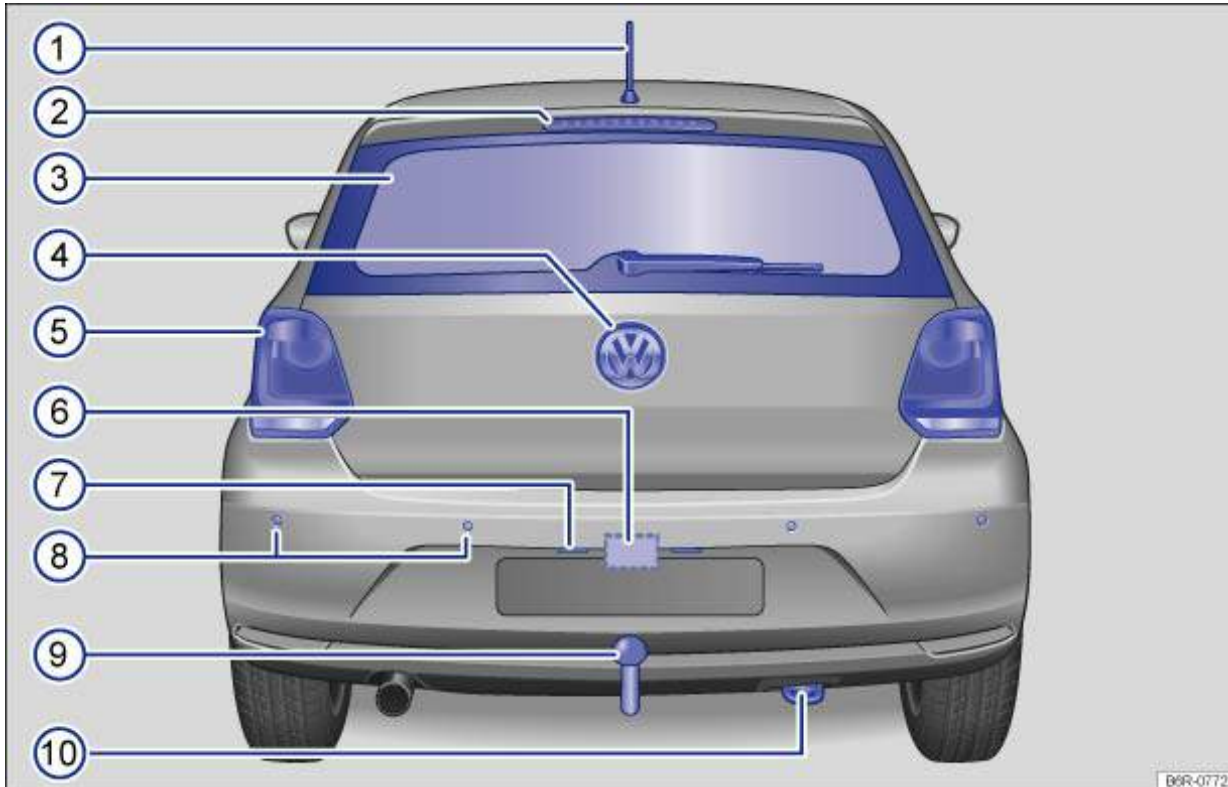


Fig. 3 Overview of the rear of the vehicle

Key to → Fig. 3:

- ① Roof aerial → *Consumer information*
- ② High-mounted brake light
- ③ Rear window with:
 - Rear wiper → *Windscreen wipers and washer* → *Caring for and cleaning the vehicle exterior*
 - Rear window heating → *Heating, ventilating, cooling*
 - Window aerial → *Consumer information*
- ④ Volkswagen badge, used for opening the tailgate → *Tailgate*
- ⑤ Rear lights (on both left and right) → *Lights* → *Changing a bulb*
- ⑥ Reversing camera settings → *Reversing camera (Rear View)*
- ⑦ Number plate lighting (on both left and right) → *Changing a bulb*
- ⑧ Rear ParkPilot sensors (on both left and right) → *ParkPilot*
- ⑨ Towing bracket → *Towing a trailer*
- ⑩ Mounting for the rear towing eye behind a cover → *Tow-starting and towing*

Vehicle interior

Overview of the driver door

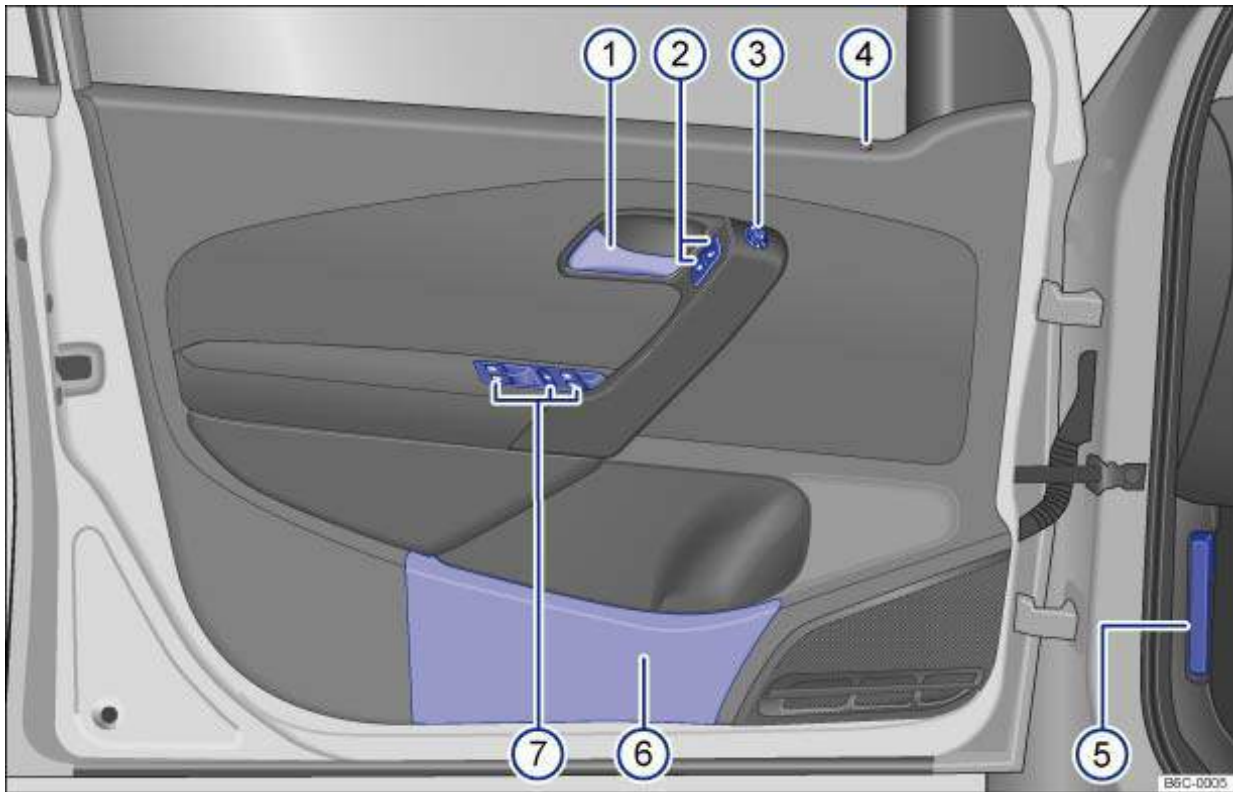








Fig. 4 Overview of the controls in the driver door (left-hand drive vehicles). The controls are mirrored in right-hand drive vehicles

Key to → Fig. 4:

- ① Door release lever → *Doors*
- ② Central locking button for locking and unlocking the vehicle  -  → *Central locking system*
- ③ Switch for adjusting the exterior mirrors: → *Mirrors*
 - Exterior mirror setting **L - 0 - R**
 - Exterior mirror heating 
 - Folding in the exterior mirrors 
- ④ Central locking system indicator lamp → *Central locking system*
- ⑤ Release lever for the bonnet → *Preparation for working in the engine compartment*
- ⑥ Stowage compartment with drink holder → *Stowage areas*
- ⑦ Buttons for operating the electric windows: → *Electric windows*
 - Electric windows 
 - Safety button for the rear electric windows 

Overview of the driver side

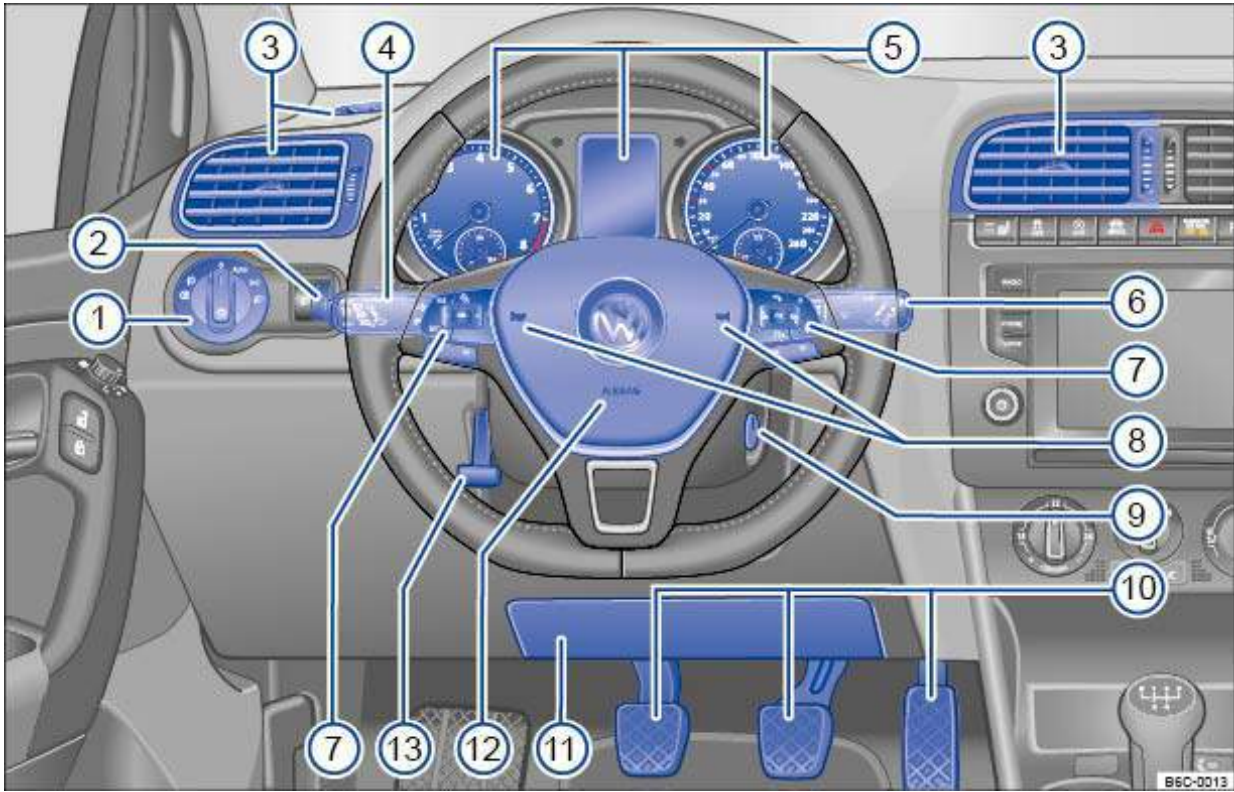


Fig. 5 Overview of the driver side (left-hand drive vehicles)

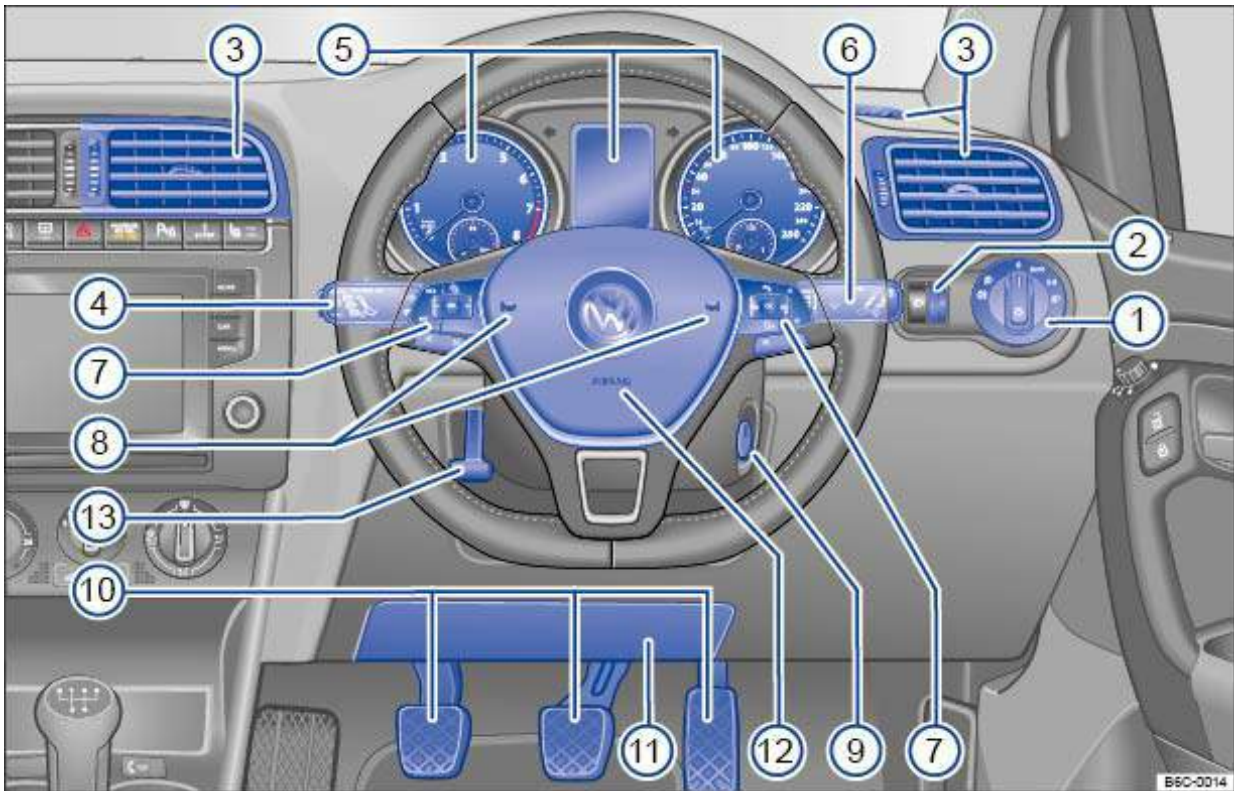













Fig. 6 Overview of the driver side (right-hand drive vehicles)

Key to → Fig. 5 and → Fig. 6:






- 1 Light switch  → *Lights*
- Daytime running lights or daytime headlights **0**
 - Automatic headlight control **AUTO**
 - Side light and dipped beam headlights , 
 - Fog lights , 

- 2 Headlight range control  → *Lights*

- 3 Vent  → *Heating, ventilating, cooling*

- 4 Lever → *Lights*
- For main beam headlights 
 - For dipped beam headlights 
 - For headlight flasher  1x
 - For turn signal 
 - For parking lights 
 - With buttons for operating the cruise control system (CCS) **ON - CANCEL - OFF**, **RES / + - SET / -** → *Cruise Control System (CCS)* .

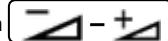
- 5 Instrument cluster:
- Instruments → *Instruments*
 - Display → *Instruments*
 - Warning and indicator lamps → *Warning and indicator lamps*




- 6 Lever for windscreen wipers and washers → *Windscreen wipers and washer*
- Windscreen wiper **HIGH - LOW**
 - Interval wipe for the windscreen **INT**
 - Length of intervals or sensitivity of the rain/light sensor 
 - Windscreen wiper switched off **OFF**
 - Flick wipe 1x
 - Windscreen wipers 
 - Wash and wipe system for the windscreen 
 - Rear wiper 
 - Wash and wipe system for the rear window 


- Control lever with buttons for operating the Volkswagen information system and the infotainment system **TRIP** , **OK / RESET** → *Volkswagen information system* → *Infotainment system*


- 7 Controls on the multifunction steering wheel → *Volkswagen information system*
- Buttons for operating the cruise control system (CCS) **RES** , **SET** ,  , **--CNL--+** → *Cruise Control System (CCS)*

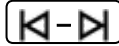
- Buttons for operating the Adaptive Cruise Control (ACC) **RES**, **SET**, ,  → *Adaptive Cruise Control (ACC)*

- Volume setting for the radio, navigation announcements or a telephone conversation 

- Buttons for operating the Volkswagen information system , , 

- Opening the main telephone menu or accepting a telephone call 

- Activating voice commands 

- Audio, navigation 

- 8** Horn (works only when the ignition is switched on)
- 9** Ignition lock → *Starting and stopping the engine*
- 10** Pedals → *Changing gear*
- 11** Fuse box cover → *Fuses*
- 12** Driver front airbag → *Airbag system*
- 13** Lever for adjusting the steering column → *Adjusting the seat position*

Overview of the centre console

Upper section of the centre console

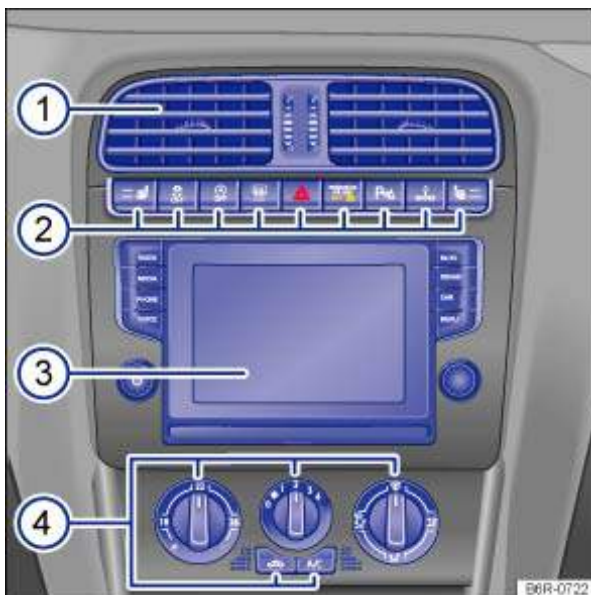












Fig. 7 Overview of the upper section of the centre console

Key to → Fig. 7:

- 1** Vent  → *Heating, ventilating, cooling*

2 Row of switches¹⁾ with buttons for:

- Seat heating left and right  /  → *Seat functions*
- Traction control system (TCS)  → *Braking, stopping and parking*
- Electronic stabilisation program (ESC)  → *Braking, stopping and parking*
- Electronic stabilisation program sport mode (ESC Sport)  → *Braking, stopping and parking*
- Start/stop system  → *Pull-away assist systems*
- Rear window heating  → *Heating, ventilating, cooling*
- Hazard warning lights  → *In an emergency*
- Indicator lamp for the front passenger front airbag switch-off function → *Airbag system*
- ParkPilot  → *ParkPilot*
- Sport Select suspension  → *Sport Select suspension*

3 Infotainment system (factory-fitted)

- Operating display → *Infotainment system*
- Radio ⇒ Booklet*Radio*,
- Navigation system ⇒ Booklet*Navigation system*,

4 Controls²⁾ for:

- Heating and fresh air system → *Heating, ventilating, cooling*
- Air conditioning system (manual) → *Heating, ventilating, cooling*
- Climatronic → *Heating, ventilating, cooling*

¹⁾ Depending on the vehicle equipment level, there could be a card holder instead of 3 buttons → *Stowage areas* .

²⁾ The symbols may differ between models.

Lower section of the centre console

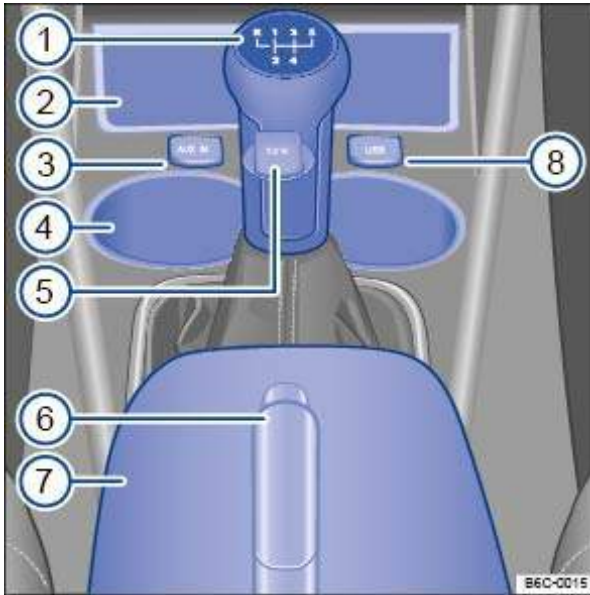



Fig. 8 Overview of the lower section of the centre console

Key to → Fig. 8:

- ① Lever for:
 - Manual gearbox → *Changing gear*
 - Automatic gearbox → *Changing gear*
- ② Stowage compartment in the front centre console → *Stowage areas*
- ③ AUX-IN socket ⇒ BookletRadio, or ⇒ BookletNavigation system,
- ④ Drink holder → *Drink holder*
- ⑤ 12-volt socket → *Socket*
- ⑥ Handbrake lever → *Braking, stopping and parking*
- ⑦ Stowage compartment in the centre armrest → *Stowage areas*
- ⑧ USB socket  ⇒ Bookletradio, or ⇒ Bookletnavigation system,

Overview of the front passenger side

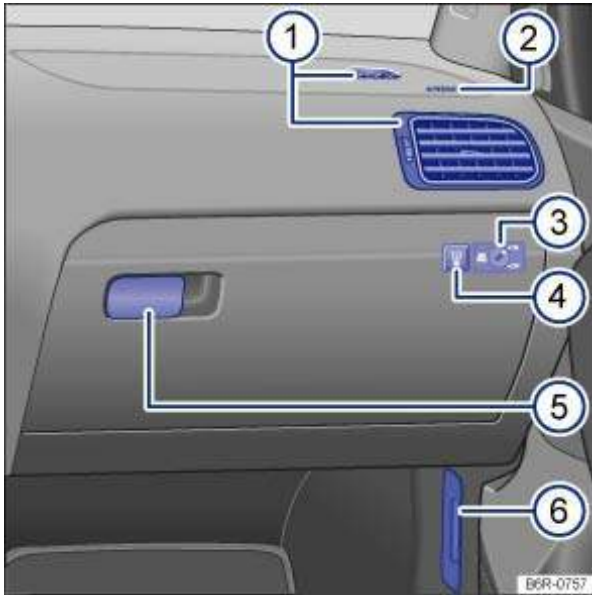


Fig. 9 Overview of the front passenger side (left-hand drive vehicles). The controls are mirrored in right-hand drive vehicles

Key to → Fig. 9:

- 1 Vent ◀-|||▶ → Heating, ventilating, cooling
- 2 Location of front passenger front airbag in the dash panel → Airbag system
- 3 Key-operated switch in the stowage compartment for switching off the front passenger front airbag → Airbag system
- 4 In the stowage compartment: button for Tyre Pressure Loss Indicator (T), SET → Tyre monitoring system
- 5 Opening lever for the stowage compartment → Stowage areas
- 6 Stowage compartment for high-visibility waistcoat → Stowage areas

Symbols in the roof

Symbol	Meaning
	Interior lights and reading lights → Lights
	Electric panorama sliding/tilting glass roof → Electric panorama sliding/tilting glass roof

Instrument cluster

Warning and indicator lamps




























The warning and indicator lamps indicate various warnings → ⚠, faults → ! or certain functions. Some warning and indicator lamps light up when the ignition is switched on and should go out once the engine is running or the vehicle is in motion.

























Depending on the vehicle's equipment level, additional text messages could appear in the display on the instrument cluster to provide further information or to ask you to perform certain tasks → Instruments .

Depending on the vehicle equipment level, symbols may be displayed in the instrument cluster instead of warning lamps.

Signal tones are given when some warning or indicator lamps light up.

For details on indicator lamps which light up in the light switch see Chapter Lighting → [Lights](#) .

Symbol	Meaning → 	See
	 Do not drive on! When this message appears, the door(s), tailgate or bonnet are open or not closed properly.	→ Instruments
	Central warning lamp. Observe the additional information on the instrument cluster display.	–
	 Do not drive on! Handbrake is applied.	→ Braking, stopping and parking
	 Do not drive on! Brake fluid level too low or fault in the brake system.	
	Flashing:  Do not drive on! Coolant level too low, coolant temperature too high, or coolant system is faulty.	→ Coolant
	Flashing:  Do not drive on! Engine oil pressure too low.	→ Engine oil
	Electromechanical steering not functioning.	→ Steering
	Brake or take avoiding action! Collision warning from the area monitoring system (Front Assist).	→ Area monitoring system (Front Assist)
	Driver or front passenger seat belt not fastened.	→ Seat belts
	Depress the brake pedal.	Changing gear → Changing gear ACC → Adaptive Cruise Control (ACC)
	Fault in the alternator.	→ Vehicle battery
	Dual clutch gearbox DSG® overheated.	→ Changing gear
	Central warning lamp. Observe the additional information on the instrument cluster display.	–
	Brake pads worn.	Infotainment system → Infotainment system Brakes → Braking, stopping and parking
	Lit up: ESC fault or switched off for system-related reasons. OR: together with ABS indicator lamp  : ABS faulty. OR: the vehicle battery has been reconnected.	
	Flashing: ESC/TCS is taking corrective action.	
	TCS switched off manually. OR: ESC switched off manually. OR: ESC switched on manually.	
	ABS faulty or not functioning.	
	Vehicle lighting not working partially or completely.	→ Changing a bulb
	Rear fog light switched on.	→ Lights
	Lit up or flashing: catalytic converter fault.	

	Lit up: glow period for a diesel engine.	Starting the engine → <i>Starting and stopping the engine</i> Engine management, exhaust gas purification → <i>Engine management system and exhaust purification system</i>
	Flashing: fault in engine management system (diesel engine).	
EPC	Engine management system fault (Electronic Power Control).	
	Diesel particulate filter has become saturated with soot.	
	Lit up: steering reduced or the vehicle battery has been disconnected and then reconnected.	→ <i>Steering</i>
	Flashing: steering column is twisted or is not unlocked/locked.	
	Tyre pressure too low or Tyre Pressure Loss Indicator faulty.	→ <i>Tyre monitoring system</i>
	Windscreen washer fluid level too low.	→ <i>Windscreen wipers and washer</i>
	Fuel tank almost empty.	→ <i>Filling the tank</i>
	Water in fuel in vehicles with a diesel engine.	
	Lit up: engine oil level too low.	→ <i>Engine oil</i>
	Flashing: engine oil system fault.	
	Fault in airbag and belt tensioner system.	→ <i>Airbag system</i>
OFF 	Front passenger front airbag switched off (PASSENGER AIR BAG OFF ).	
ON 	Front passenger front airbag switched on (PASSENGER AIR BAG ON ).	
	Adaptive Cruise Control (ACC) currently not available.	→ <i>Adaptive Cruise Control (ACC)</i>
	Fault in Sport Select suspension.	→ <i>Sport Select suspension</i>
	Gearbox fault.	→ <i>Changing gear</i>
	Hazard warning lights switched on.	→ <i>In an emergency</i>
	Turn signal, left or right.	→ <i>Lights</i>
	Trailer turn signal.	
	Lit up: depress the brake pedal.	Starting the engine → <i>Starting and stopping the engine</i> Changing gear → <i>Changing gear</i> Brakes → <i>Braking, stopping and parking</i>
	Flashing: the lock button in the selector lever is not engaged.	
	The cruise control system (CCS) is switched on.	→ <i>Cruise Control System (CCS)</i>
	Adaptive Cruise Control (ACC) is active.	→ <i>Adaptive Cruise Control (ACC)</i>
	Main beam is switched on or the headlight flasher is being operated.	→ <i>Lights</i>
	ACC is active. No vehicle has been detected ahead.	→ <i>Adaptive Cruise Control (ACC)</i>
	When displayed in white: ACC active. Vehicle detected ahead.	
	When displayed in grey: ACC not active. System switched on, does not regulate.	
	Lit up: service alert / service due.	→ <i>Instruments</i>

	Flashing: fault in automatic gearbox.	→ <i>Changing gear</i>
	The start/stop system is not available. Automatic engine switch-off is active.	→ <i>Pull-away assist systems</i>
	Start/stop system not available. OR: the engine was started automatically.	
	The engine is starting.	
	A mobile telephone is connected via Bluetooth to the factory-fitted provision for mobile telephone.	⇒ Booklet <i>Provision for mobile telephone,</i>
	Mobile telephone battery charge level. Only for factory-fitted provision for mobile telephone.	
	The outside temperature is below +4°C (+39°F).	→ <i>Instruments</i>
	Note about information in the vehicle wallet.	–

WARNING

Failure to observe illuminated warning lamps and text messages can lead to your vehicle breaking down in traffic, and can cause accident and serious injury.

- Never ignore any illuminated warning lamps or text messages.
- Stop the vehicle as soon as possible and when safe to do so.
- Stop the vehicle at a safe distance away from moving traffic and make sure that no part of the exhaust system can come into contact with any inflammable material underneath the vehicle, e.g. dry grass or fuel.
- Any broken-down vehicle poses an increased accident risk, both for you and for other road users. If the situation requires, switch on the hazard warning lights and set up the warning triangle as a warning to other road users.
- Before opening the bonnet, switch off the engine and allow it to cool down sufficiently.
- The engine compartment of any motor vehicle is a dangerous area. Serious injuries can be sustained here → *Preparation for working in the engine compartment* .

NOTICE

Failure to observe illuminated indicator lamps and text messages can lead to your vehicle being damaged.

Instruments

Introduction

This chapter contains information on the following subjects:

- *Instrument overview*
- *Displays*
- *Service interval display*

Additional information and warnings:

- Warning and indicator lamps → *Warning and indicator lamps*
- Volkswagen information system → *Volkswagen information system*
- Infotainment system → *Infotainment system*

- Selected gear display (for vehicles with an automatic gearbox) → *Changing gear*
- Information on service intervals ⇒ Booklet *Service schedule*,

⚠ WARNING

Accidents and injuries can occur if the driver is distracted.

- Never press the buttons on the instrument cluster while the vehicle is in motion.

Instrument overview



Fig. 10 Instrument cluster in the dash panel (variant 1)




Fig. 11 Instrument cluster in the dash panel (variant 2)

📖 First read and observe the introductory information and safety warnings → ⚠ *Introduction*

Descriptions of the instruments → Fig. 10 or → Fig. 11:

① **Rev. counter** (running engine speed in revolutions x 1,000 per minute). The start of the red zone on the dial indicates the maximum engine speed that may be used in each gear when the engine is warm and after it has been run in properly. You should change up a gear or move the selector lever to D (or lift your foot off the accelerator) before the needle reaches the red zone → ⚠.

② **Displays** → *Displays* .

- 3 Speedometer
- 4 Setting button for the clock → *Time* ¹⁾.
- 5 Reset button for the trip recorder display (trip).
- Press the **0.0 / SET** button to reset to 0.
- 6 Coolant temperature display  → *Coolant* .
- 7 Fuel gauge → *Filling the tank* .

NOTICE

- When the engine is cold, avoid high engine speeds, driving at full throttle and overloading the engine.
- The needle on the rev counter should only briefly point into the red area, as engine damage may otherwise be incurred.



Changing up a gear early will help to save fuel and minimise engine noise.



The fuel gauge is located in the lower field of the display → [Fig. 10](#) or in the speedometer → [Fig. 11](#) .

¹⁾ In some versions of the vehicle, it may be possible to adjust the clock settings using the **Settings** menu on the instrument cluster display → [Volkswagen information system](#) .

Displays

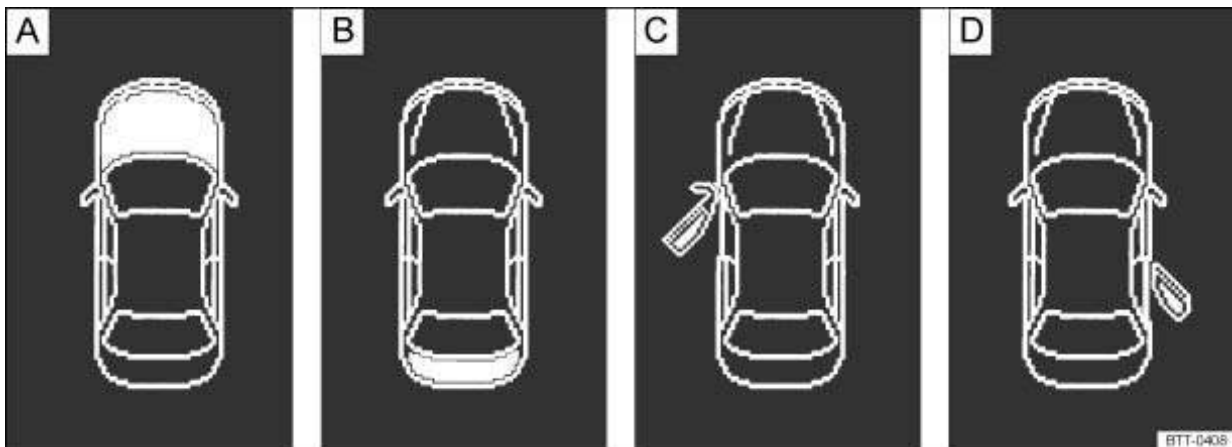


Fig. 12 A: bonnet open, B: tailgate open, C: front left door open, D: right rear door open (only in four-door vehicles)



First read and observe the introductory information and safety warnings →  [Introduction](#)

When the outside temperature is low, the display in the instrument cluster may take slightly longer to appear than it does when the outside temperatures is higher.

Depending on the vehicle equipment level, a variety of information can be displayed in the instrument cluster → [Fig. 10](#) or → [Fig. 11](#) :

- Open doors, bonnet and tailgate → [Fig. 12](#)
- Warning and information messages

- Mileage displays
- Time
- Radio and navigation information → Booklet*Radio*, or → Booklet*Navigation system*,
- Telephone information → Booklet*Navigation system*, or → Booklet*Radio/navigation system*,
- Outside temperature
- Compass display
- Selector lever positions → *Changing gear*
- Gear change indicator → *Changing gear*
- Driving data display (multifunction display (MFD)) and menus for various settings → *Volkswagen information system*
- Service interval display → *Service interval display*
- Speed warning for winter tyres
- Start/stop system status display → *Pull-away assist systems*
- Status display for active cylinder management (ACT®) → *Driving with respect for the environment*
- Engine code
- Fuel gauge → *Filling the tank*

Open doors, bonnet and tailgate

The instrument cluster display indicates if any doors, or the bonnet or tailgate, are open once the vehicle has been unlocked, and while the vehicle is in motion. In some cases, a signal tone is also given. Different instrument cluster designs will have different displays.


Key to → Fig. 12		See
A	Do not drive on! The bonnet is open or not properly closed.	→ <i>Preparation for working in the engine compartment</i>
B	Do not drive on! Tailgate open or not properly closed.	→ <i>Tailgate</i>
C, D	Do not drive on! The vehicle door is open or not properly closed.	→ <i>Doors</i>

Warning and information messages

The system checks certain components and functions in the vehicle when the ignition is switched on or while the vehicle is in motion. Functional faults are indicated by red and yellow warning symbols with information messages on the instrument cluster display → *Warning and indicator lamps* . An acoustic warning is also given in certain cases. Different instrument cluster designs will have different displays.

In addition, a list of current malfunctions can be opened manually. To do so, choose **Vehicle status** or **Vehicle** in the selection menu → *Volkswagen information system* .

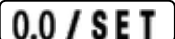
Type of message	Symbol colour	Explanation
Priority 1 warning message.	Red	The symbol flashes or lights up (sometimes together with a signal tone). Do not drive on! Danger → ! Check the fault and correct the cause. Seek expert assistance if necessary.
		The symbol flashes or lights up (sometimes together with a signal tone).

Priority 2 warning message.	Yellow	Your vehicle could be damaged or break down if there is a fault or if service fluids are running low →  . Check the fault as soon as possible. Seek expert assistance if necessary.
Information message.	–	Information about various procedures within the vehicle.

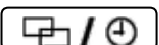
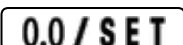
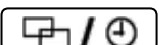
Mileage displays

The *odometer* registers the total distance travelled by the car.

The *trip recorder (trip)* shows the distance travelled since the trip recorder was last reset. The final digit shows distances of 100 m.

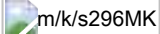

- Press button  in the instrument cluster → [Instrument overview](#) briefly to reset the trip recorder to 0.

Time

- Press the  button to mark either the hours or minutes display → [Fig. 10 ④](#) or → [Fig. 11 ④](#) .
- Press the  button to set the time → [Fig. 10 ⑤](#) or → [Fig. 11 ⑤](#) . Press and hold to scroll through quickly.
- Press the  button again to finish setting the clock.

You can also set the time in the infotainment system using the  button and the  and  function buttons → [Menu and system settings \(SETUP\)](#) .

Outside temperature display

If the outside temperature is lower than approx. +4 °C (+39 °F), an acoustic signal in the form of a gong will sound to inform the driver, and a snowflake symbol will appear in addition to the outside temperature display . This symbol flashes and then remains constantly lit until the outside temperature rises above +6°C (+43°F) → .

When the vehicle is stationary or travelling at very low speeds, the temperature displayed may be slightly higher than the actual outside temperature as a result of the heat radiated from the engine.

The measuring range lies between -45 °C (-49 °F) and +76 °C (+169 °F).

Compass display

When the ignition and navigation system are switched on, the instrument cluster display shows the current direction of travel.

Selector lever positions (automatic gearbox)



The gear selected is displayed on the side of the selector lever and can also be displayed in the instrument cluster. In **D** or **S**, or in Tiptronic mode, the display may show which gear has been selected → [Changing gear](#) .

Gear-change indicator

While the vehicle is in motion, the instrument cluster may show which gear should be selected to reduce fuel consumption → [Changing gear](#) .

Second speed display (mph or km/h)



In addition to the tachometer display, the speed can also be displayed in another unit of measurement (mph or km/h) while you are driving.

Settings for the second speed display can be made and adjusted in the infotainment system using the  and the function buttons , **Units** and **Speed** → [Menu and system settings \(SETUP\)](#) .

It is not possible to switch off the second speedometer display in those countries where the law stipulates that the display cannot be deactivated.

Speed warning for winter tyres

A display in the instrument cluster indicates when the set maximum speed has been exceeded → [Volkswagen information system](#) .

Speed warning settings can be made and adjusted in the infotainment system using the  button and the  and **Tyres** function buttons → [Menu and system settings \(SETUP\)](#) .

Start/stop system status display

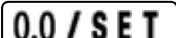
The instrument cluster display shows information about the current status → [Pull-away assist systems](#) .

Status display for active cylinder management (ACT®)

Depending on equipment levels, some vehicles will indicate the current number of active cylinders in the instrument cluster display, e.g. **2 cylinder mode**.

For this purpose, the menu option **Current fuel consumption**, **Average consumption** or **Range** must be selected in the menu **MFI** → [Volkswagen information system](#) .

Engine code

Press and hold button  in the instrument cluster → [Instrument overview](#) for at least 15 seconds to view the vehicle's engine code (EC) in the display. The ignition should be switched on but the engine should not be running.



WARNING

Failure to observe illuminated warning lamps and text messages can lead to your vehicle breaking down in traffic, and can cause accident and serious injury.

- Never ignore any illuminated warning lamps or text messages.
- Stop the vehicle as soon as possible and when safe to do so.
- Any broken-down vehicle poses an increased accident risk, both for you and for other road users. If the situation requires, switch on the hazard warning lights and set up the warning triangle as a warning to other road users.
- Stop the vehicle at a safe distance away from moving traffic and make sure that no part of the exhaust system can come into contact with any inflammable material underneath the vehicle, e.g. dry grass or fuel.

⚠ WARNING

Streets and bridges can also be iced over at outside temperatures above zero degrees.

- The snowflake symbol indicates that there is a risk of black ice.
- There may be black ice on the roads even when outside temperatures are above +4°C (+39°F), even when no snowflake symbol is displayed.
- You should never rely solely on the outside temperature display!

ⓘ NOTICE

Failure to observe illuminated indicator lamps and text messages can lead to your vehicle being damaged.



Different instrument clusters are available, which means that the versions and displays may vary. In displays without warning or information texts, faults are indicated exclusively by the indicator lamps.



Depending on the vehicle equipment level, some settings and displays may also appear in the infotainment system.



If several warning reports are detected, the symbols will appear for several seconds, one after another. The symbols will continue to appear until the faults are rectified.



If warning messages about malfunctions are displayed when the ignition is switched on, it may not be possible to adjust some settings as described, or the information display may appear differently. If this is the case, take the vehicle to a qualified workshop to have the malfunction rectified.

Service interval display

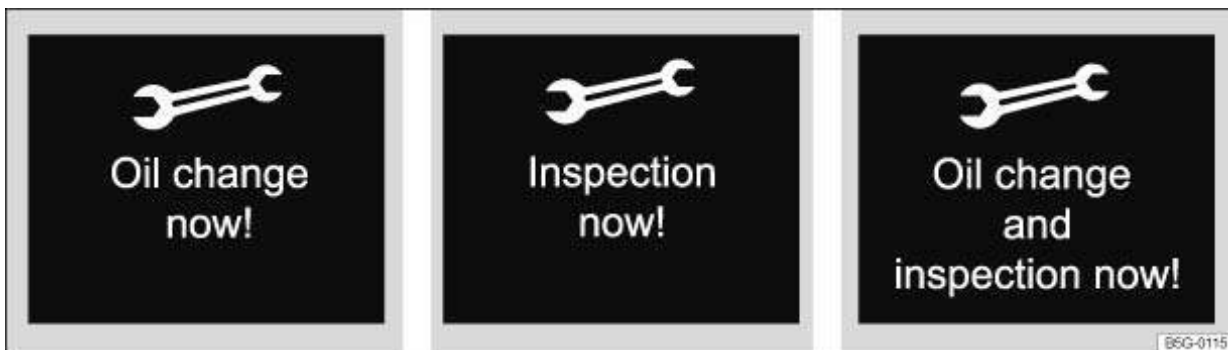


Fig. 13 Schematic diagram: examples of displays in instrument cluster when a service is due

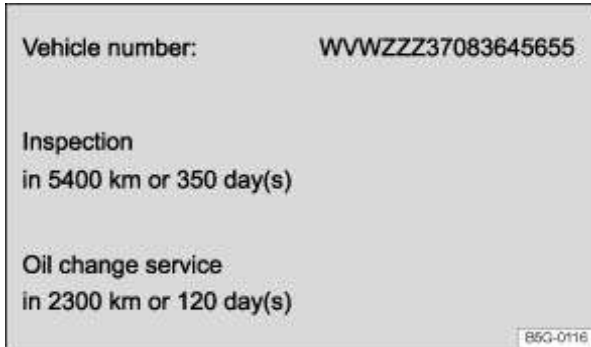


Fig. 14 An example of the service information shown in the infotainment system



First read and observe the introductory information and safety warnings →  [Introduction](#)

The service displays are shown on the instrument cluster → [Fig. 13](#) and in the infotainment system → [Fig. 14](#).

Versions and displays can vary as different versions of the instrument cluster and of the infotainment system are available.

Service schedules at Volkswagen are divided into two categories, oil change service and inspections. The service interval display provides information on the next service which includes an oil change and on the next scheduled inspection. Scheduled services can also be found in the service schedule.

In vehicles with **fixed oil change service**, services take place at predefined intervals.


The service intervals are calculated on an individual basis in vehicles with **flexible oil change service**. Advances in technology have brought about a considerable reduction in servicing requirements. An oil change service must only be carried out when required by the vehicle. The individual conditions in which the vehicle is used, as the driver's personal driving style, are taken into account. The service reminder is displayed 30 days before the service is due. The distance is rounded to the nearest 100 km; the remaining time is rounded to full days.

Service alert

If an oil change service or inspection is due soon, a service alert will appear the next time the ignition is switched on.

The number of kilometres or amount of time shown correspond to the maximum number of kilometres or maximum time that can still be driven before the next service.

Service event

For a **scheduled oil change** or a **scheduled inspection** a signal tone will be given when the ignition is switched on and the spanner symbol  will be displayed for several seconds on the instrument cluster display. One of the following displays will also appear → [Fig. 13](#):

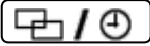
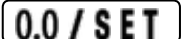
Inspection now!

Oil change now!




Oil change and inspection now!

Accessing a service message

You can access the current service schedule when the ignition is switched on, the engine is not running, and the vehicle is stationary:

- Press button  in the instrument cluster → [Instrument overview](#) until the word **Service** appears in the display.
- Release the button and wait for approx. 2 seconds or press .

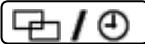
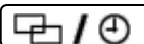

- The number of kilometres or amount of time until the next oil change service is shown in the display, followed by the same information for the next inspection.

Service information → *Fig. 14* can also be displayed in the infotainment system by pressing the  button and the  and  function buttons → *Menu and system settings (SETUP)* .

An **overdue service** is indicated by a minus sign in front of the mileage or trip reading.

Resetting oil change service

If the oil change service was not performed by a Volkswagen workshop, it can be reset as follows:

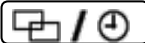
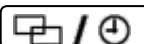
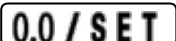
- Switch off the ignition.
- Press and hold down the  button in the instrument cluster → *Instrument overview* .
- Restart the ignition.
- Release the  button.
- Confirm the query in the instrument cluster with the  button.


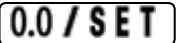
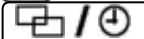
Do **not** reset the display between service intervals. This can lead to incorrect information being displayed.


If you manually reset the service interval display while flexible oil change service is valid, fixed oil change service will be activated. The service interval will no longer be calculated on an individual basis ⇒ *Booklet Service schedule*, .

Resetting inspection

If the inspection was not performed by a Volkswagen workshop, it can be reset as follows:

- Switch off the ignition.
- Press and hold down the  button in the instrument cluster → *Instrument overview* .
- Restart the ignition.
- Release the  button and press it again.
- Confirm the query in the instrument cluster with the  button.

 The service message will go out after a few seconds once the engine is running or by pressing the  /  → *Instrument overview* button.

 If the vehicle battery is disconnected for long periods in a vehicle with flexible oil change service, the system will not be able to calculate the time when the next service is due. The service displays could then display incorrect information. If this is the case then please observe the maximum service intervals shown in ⇒ *Booklet Service schedule*, .

Volkswagen information system

Introduction

This chapter contains information on the following subjects:

- *Overview of the menu structure*
- *Using the selection menu in the instrument cluster*

→ [Selection menu](#)

→ [Driving data](#)

→ [menu](#)

When the ignition is switched on, the various display functions can be accessed via the selection menu, e.g. the driving data display (multifunction display (MFD)).

There are no buttons on the windscreen wiper lever in vehicles equipped with a multifunction steering wheel. The multifunction display is controlled using the buttons on the multifunction steering wheel only.

The scope of the menus and information shown on the instrument cluster display depends on the vehicle electronics and the vehicle equipment level.

Qualified workshops can program and modify other functions depending on the vehicle equipment level. Volkswagen recommends using a Volkswagen dealership for this purpose.

Some menu options can only be called up when the vehicle is stationary.

If any priority 1 warning reports are being displayed, you will be unable to access any menus or information displays. A few warning messages can be confirmed and hidden by pressing the **OK/RESET** button on the windscreen wiper lever or the **OK** button on the multifunction steering wheel.

Additional information and warnings:

- Infotainment system → [Infotainment system](#)
- Driver assist systems → [Driver assist systems](#)
- Radio or navigation system ⇒ Booklet *Radio*, or ⇒ Booklet *Navigation system*,
- Provision for mobile telephones ⇒ Booklet *Provision for a mobile telephone*,



WARNING

Accidents and injuries can occur if the driver is distracted.

- Never open the menus on the instrument cluster display while the vehicle is in motion.



After starting the engine with a discharged vehicle battery, or after the battery has been changed, system settings (time, date, personal convenience settings and programming) may have been changed or deleted. Check and correct the settings as necessary once the vehicle battery has been sufficiently charged.

Overview of the menu structure



First read and observe the introductory information and safety warnings →  [Introduction](#)

The following menu structure shows how the Volkswagen information system menus on the instrument cluster display are structured. The size and layout of the Volkswagen information system menu depends on the vehicle electronics and the level of vehicle equipment.

- **Driving data** → [Driving data](#)
 - Since start
 - Since refuel

- Long-term
- Speed warning function
- Digital speed
- Range
- Convenience consumers
- **Driver assist systems** → *Selection menu*
 - Front Assist on/off
 - Adaptive Cruise Control (ACC)
- **Navigation** ⇒ Booklet*Navigation system,*
- **Audio** ⇒ Booklet*Radio,* or ⇒ Booklet*Navigation system,*
- **Telephone** ⇒ Booklet*Provision for mobile telephone,* , ⇒ Booklet*Navigation system,* / ⇒ Booklet*Radio/navigation system,*
- **Vehicle status** → *Selection menu*

Using the selection menu in the instrument cluster



Fig. 15 Vehicles without a multifunction steering wheel: button ① on the windscreen wiper lever for confirming menu points, and rocker switch ② for changing menus and information displays







Fig. 16 Right-hand side of the multifunction steering wheel: controls for using the menus and information displays in the instrument cluster






First read and observe the introductory information and safety warnings →  *Introduction*

Opening the selection menu and selecting the menu or information display



- Switch on ignition.

- If a message or vehicle pictogram is displayed, press button → [Fig. 15 ①](#) on the windscreen wiper level or the  button on the multifunction steering wheel → [Fig. 16](#). You may need to press the button several times.
- *Operation using the windscreen wiper lever:* to display the selection menu → [Selection menu](#) or to return to the selection menu from another menu or information display, press and hold the rocker switch → [Fig. 15 ②](#) until the selection menu is displayed. To browse through the selection menu, press the rocker switch up or down.
- *Operation using the multifunction steering wheel:* to display and browse through the selection menu, press  or  → [Fig. 16](#).
- To open the menu or information display shown in the selection menu, press → [Fig. 15 ①](#) on the windscreen wiper lever, press the  button on the multifunction steering wheel → [Fig. 16](#), or wait until the menu or information display opens automatically after a few seconds.

Adjusting settings in menus

- In the displayed menu, press the rocker switch → [Fig. 15 ②](#) on the windscreen wiper lever up or down, or press the arrow buttons  or  on the multifunction steering wheel → [Fig. 16](#) until the required menu option is selected. A frame appears around the selected option.
- Press button → [Fig. 15 ①](#) on the windscreen wiper lever or press the  button on the multifunction steering wheel → [Fig. 16](#) to make the required change. A tick indicates that the particular system or function is active.

Returning to the selection menu

- *Using the menu:* in the menu, select the **Back** menu option to leave the menu.
- *Using the multifunction steering wheel:* press the  or  button → [Fig. 16](#).



If warning messages about malfunctions are displayed when the ignition is switched on, it may not be possible to adjust some settings as described, or the information display may appear differently. If this is the case, take the vehicle to a qualified workshop to have the malfunction rectified.

Selection menu



First read and observe the introductory information and safety warnings →  [Introduction](#)

Menu	Function	See
Driving data	Information and settings for the multifunction display (MFD). Display of current warning or information messages and other system components depending on the equipment level.	→ Driving data , → Menu and system settings (SETUP)
Assist systems	Information and settings for the driver assist systems.	→ Assist systems menu , → Menu and system settings (SETUP)
Navigation	Information displays from active navigation system: Turning arrows and proximity bars are displayed if you use active route guidance. The design is similar to the symbols used in the infotainment system. The direction of travel (compass function) and the name of the road being used are displayed if the route guidance option is not active.	⇒ BookletNavigation system ,
Audio	Station display in radio mode. Display of station list in radio mode. Track display in media mode.	⇒ BookletRadio , / ⇒ BookletNavigation system ,

Telephone	Display telephone information. Using the telephone.	⇒ Booklet <i>Provision for a mobile telephone</i> , ⇒ Booklet <i>Navigation system, I</i> ⇒ Booklet <i>Radio/navigation system</i> ,
Vehicle status / Vehicle	Display and storage of current warning or information texts. The menu option only appears if warning and information texts are available.	→ <i>Instruments</i> , → <i>Menu and system settings (SETUP)</i>

Driving data



First read and observe the introductory information and safety warnings → *Introduction*

The multifunction display (MFD) shows a variety of travel and fuel consumption data. MFA is called up from the selection menu → *Using the selection menu in the instrument cluster* .

Switching between displays

- *Vehicles without a multifunction steering wheel:* press the rocker switch **TRIP** on the windscreen wiper lever → *Fig. 15*.
- *Vehicles with a multifunction steering wheel:* press the or button → *Fig. 16*.

Driving data recorder

The MFD is fitted with 3 automatic recorders:

- **Since start**
- **Since refuel**
- **Long-term**

The currently selected memory is shown in the display.


Press the **OK/RESET** button on the windscreen wiper lever or press the **OK** button on the multifunction steering wheel to switch between recorders when the ignition is switched on and the recorder is displayed.

Display	Function
Since start	Display and storage of gathered driving and consumption values from the time the ignition is switched on until it is switched off. If the journey is continued within approximately 2 hours of the ignition being switched off, the new values are also taken into account. The memory will automatically be deleted if the journey is interrupted for more than 2 hours.
Since refuel	Display and storage of the collected driving and consumption values. The memory is deleted automatically when the vehicle is refuelled.
Long-term	The memory collects journey data for any number of individual journeys up to a total of 19 hours and 59 minutes or 99 hours and 59 minutes journey time or 1,999.9 km or 9,999.9 km distance travelled. If one of these maximum limits ^{a)} is exceeded, the memory is automatically deleted and reset to 0.

Deleting the driving data recorder manually

- Select the memory that you wish to delete.
- Press and hold the **OK/RESET** button on the windscreen wiper lever, or the **OK** button on the multifunction steering wheel, for approximately 2 seconds.



Personal selection of displays

You can set which MFD display should appear in the instrument cluster using the **CAR** button and the  and **Multifunction display** function buttons in the infotainment system → *Menu and system settings (SETUP)* .

Examples of display

Display	Function
Consumption	The current fuel consumption is displayed in litres/100 km while the vehicle is in motion, and in litres/hour while the vehicle is stationary.
Av. consumption	The average fuel consumption will be shown after a distance of approximately 300 metres has been travelled. The display will show dashes until this point. The displayed value is updated approximately every second.
Range	Approximate calculation of the distance in km that can still be travelled with the current fuel level under the current driving conditions. One factor used for calculating this figure is the current level of fuel consumption.
Travel time	Driving time in hours (h) and minutes (min) that has elapsed since the ignition was switched on.
Distance	The distance travelled in km since the ignition was switched on.
Av. speed	The average speed will be shown after a distance of approximately 100 metres has been travelled. The display will show dashes until this point. The displayed values will be updated approximately every 5 seconds.
Digital speed display	Current vehicle speed displayed digitally.
Speed warning — km/h or Warning at — mph	If the saved speed (within the range of 30 km/h (18 mph) and 250 km/h (155 mph)) is exceeded, a signal tone will be given, along with a visible warning if required.
Oil temp.	Current temperature of the engine oil displayed digitally.
Coolant	Current coolant temperature displayed digitally.

Saving a speed for the speed warning

- Select display **warning at — km/h** or **Warning at — mph**.
- Press the **OK/RESET** button on the windscreen wiper lever, or the **OK** button on the multifunction steering wheel to save the current speed and activate the warning system.
- If necessary, use the **TRIP** rocker switch on the windscreen wiper lever, or the  or  buttons on the multifunction steering wheel, within approximately 5 seconds to set the desired speed. Then press the **OK/RESET** or **OK** button again, or wait a few seconds. The speed is now saved and the warning is activated.
- *To deactivate*, press the **OK/RESET** or **OK** button. The stored speed will be deleted.

a) Changes depending on the instrument cluster version.

Assist systems menu



First read and observe the introductory information and safety warnings →  *Introduction*

Menu

Function

Front Assist	Switches the area monitoring system on or off → <i>Area monitoring system (Front Assist)</i> .
ACC	Adaptive cruise control display → <i>Adaptive Cruise Control (ACC)</i> .

Infotainment system

Menu and system settings (SETUP)

Introduction

This chapter contains information on the following subjects:

- *Vehicle settings menu*
- *Think Blue. Trainer.*


Additional information and warnings:

- Instruments → *Instruments*
- Volkswagen information system → *Volkswagen information system*
- Central locking system → *Central locking system*
- Electric windows → *Electric windows*
- Lights → *Lights*
- Windscreen wipers/washer → *Windscreen wipers and washer*
- Mirrors → *Mirrors*
- Brake support systems → *Braking, stopping and parking*
- Driving with respect for the environment → *Driving with respect for the environment*
- Driver assist systems → *Driver assist systems*
- Wheels and tyres → *Wheels and tyres*
- ⇒ Booklet*Radio* , or ⇒ Booklet*Navigation system*,

General information on operating the unit

The following section contains information on the settings that can be adjusted in the **Vehicle settings** menu. Basic information on operating the infotainment system and on warning and safety instructions are contained in a separate manual ⇒ Booklet*Radio*, or ⇒ Booklet*Navigation system*, .

Systems settings and display of vehicle information

After pressing the  infotainment button you can touch the corresponding function button to display information or adjust settings, e.g. you can check the current status of the start/stop system → *Pull-away assist systems* in the **Vehicle status** menu.

- Vehicle settings (setup) → *Vehicle settings menu* .
- Radio station selection.
- Active media.
- Vehicle status.
- Driving data.
- Convenience consumers.

WARNING

Accidents and injuries can occur if the driver is distracted. Operating the navigation system can distract you from the road.

- Always drive carefully and responsibly.





After starting the engine with a discharged vehicle battery, or after the battery has been changed, system settings (time, date, personal convenience settings and programming) may have been changed or deleted. Check and correct the settings as necessary once the vehicle battery has been sufficiently charged.

Vehicle settings menu




First read and observe the introductory information and safety warnings →  [Introduction](#)

Opening the Vehicle settings menu

- Switch on ignition.
- Switch on infotainment system if necessary.
- Press the  infotainment button.
- Touch the  function button to open the **Vehicle settings** menu.
- Touch the corresponding function button to open additional menus in the **Vehicle settings** menu, or to adjust settings in the menu points.

If the checkbox in the function button is ticked , the respective function is switched on.

Changes made in settings menus are automatically applied immediately after entry.

Touching the  function button takes you back to the previous menu.

Menu overview

The following menu overview is an example of the infotainment system menu structure. The size and layout of the Volkswagen information system menu depends on the vehicle electronics and the level of vehicle equipment.

Menu	Submenu	Settings options	Further information
ESC system	-	The following systems can be activated or deactivated: – Traction control system (TCS), – Electronic stabilisation programme (ESC), – Electronic stabilisation program sport mode (ESC Sport).	→ <i>Braking, stopping and parking</i>
Tyres	Tyre Pressure Loss Indicator	Store the tyre pressures (SET).	→ <i>Tyre monitoring system</i>
	Winter tyres	Activation or deactivation of the speed warning. Setting the speed warning value.	→ <i>Wheels and tyres</i>
	ACC (Adaptive Cruise Control)	Activation or deactivation of the last selected distance. Setting the time interval to the vehicle in front (distance setting).	→ <i>Adaptive Cruise Control (ACC)</i>

Driver assistance	Front Assist (area monitoring system)	The following systems can be activated or deactivated: – Area monitoring system, – Advance warning, – Distance warning display.	→ <i>Area monitoring system (Front Assist)</i>
	Driver Alert System	Activation or deactivation of the Driver Alert System.	→ <i>Driver Alert System (recommendation for rest breaks)</i>
Parking/manoeuvring,	ParkPilot	Activation or deactivation of automatic activation of the ParkPilot. The following functions can be set: – Front and rear volume, – Front and rear tone, – Audio volume reduction.	→ <i>ParkPilot</i>
Lights	Light Assist	The following systems can be activated or deactivated: – Automatic dipped headlights (when raining), – Lane change flash. The following functions can be set: – Switch-on time for automatic headlight control, – Travel mode (right-hand or left-hand drive).	→ <i>Lights</i>
	Interior lighting	Setting the instrument and switch lighting	
	Coming Home/Leaving Home function	The following functions can be set: – Duration that the Coming Home function is switched on, – Duration that the Leaving Home function is switched on,	
Mirror and wipers	Mirrors	Activating and deactivating the folding-in function when parking.	→ <i>Mirrors</i>
	Wipers	The following systems can be activated or deactivated: – Automatic wipe function when raining, – Rear window wipers in reverse gear.	→ <i>Windscreen wipers and washer</i>
Opening/closing	Central locking	Setting door unlocking. Activation or deactivation of automatic locking.	→ <i>Central locking system</i>
Instrument cluster	–	The following systems can be activated or deactivated: – Current fuel consumption, – Average fuel consumption, – Top-up volume, – Convenience consumers, – Eco tips, – Travel time, – Distance, – Average speed, – Digital speed display, – Speed warning function, – Oil temperature. The following data can be reset: – Driving data since start, – Driving data long-term.	→ <i>Volkswagen information system</i>
		The following functions can be set: – Clock time source (manual, GPS), – Time,	

Time and date	-	<ul style="list-style-type: none"> - Time format (12h, 24h), - Set summer time automatically, - Time zone, - Date, - Date format. 	-
Units	-	<p>The following functions can be set:</p> <ul style="list-style-type: none"> - Distance, - Speed, - Temperature, - Volumes, - Consumption, - Pressure. 	-
Service	-	<p>The following data are displayed:</p> <ul style="list-style-type: none"> - Vehicle identification number, - Date of next inspection, - Date of next oil change service. 	→ <i>Instruments</i>
Factory settings	-	<p>The following settings can be reset:</p> <ul style="list-style-type: none"> - All settings, - Driver assistance, - Parking/manoeuvring, - Lights, - Mirror and wipers, - Opening/closing, - Multifunction display. 	-

Think Blue. Trainer.



Fig. 17 Infotainment system screen: overview of Think Blue. Trainer.

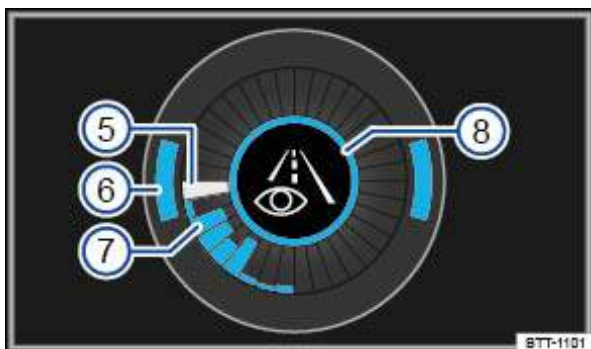






Fig. 18 Infotainment system screen: driving style display.



First read and observe the introductory information and safety warnings → ⚠ *Introduction*

The Think Blue. Trainer. informs the driver of their driving style. Information about driving style is evaluated and displayed only when driving forwards.

Display/function button: meaning

	Blue Score: driving style display (44/100).
①	Shows driving efficiency from 0 to 100. The higher the value, the more efficient your driving style is. Touch the display to receive detailed information. The last 30 minutes of driving since the start of the journey are displayed as statistics. If you have not yet been driving for 30 minutes, the values of the previous journey are shown in grey.
	Evaluation of efficient driving
②	Driving efficiency is shown on the display ② via various elements.
	l/100 km: Average fuel consumption (5.1).
③	Shows the average fuel consumption. The value refers to the distance travelled since the start of the journey. Touch the display to receive detailed information. The last 30 minutes of driving since the start of the journey are displayed as statistics. If you have not yet been driving for 30 minutes, the values of the previous journey are shown in grey.
	Think Blue. : Further tips for saving fuel.
④	Tips on fuel-efficient driving can be selected via the Think Blue. function button.
	White segment for the current time.
⑤	Shows the position of the value currently evaluated.
	Arc to illustrate acceleration.
⑥	Acceleration is shown via the position of the arc ⑥ in the outer ring. At a constant speed, the arc stays in the middle. When accelerating or braking, the arc moves upwards or downwards accordingly.
	Segments for displaying efficient driving style.
⑦	Recent driving efficiency is shown as in the centre ring, and is updated clockwise approximately every five seconds. The larger the blue area in the segments, the more efficient your driving style is.
	Various symbols can be displayed in the inner ring which report on your current driving style.
	 : thinking ahead when driving.
⑧	 : gear change indicator.
	 : current speed is adversely affecting fuel consumption.
	 : ecological driving style.

The blue colouring is an indication of an efficient and consistent driving style. If the edges of the displays ① and ③ are coloured blue, your driving style is highly efficient. The edges of the displays are coloured grey if your driving style is inefficient.

Selecting Think Blue. Trainer.

When the vehicle is stationary, press the **CAR** button in the infotainment system.

Press the **View** function button and select **Think Blue. Trainer.**



WARNING

Do not allow the images shown on the infotainment system screen to distract you from the traffic around you.

- Always pay close attention to what is happening around the vehicle.

Before the journey

Before setting off

Driving tips

Introduction

This chapter contains information on the following subjects:

- *Preparing for a journey and driving safely*
- *Driving abroad*
- *Driving through water on roads*

An engine and transmission guard may prove useful, depending on the conditions in which the vehicle is to be driven. An engine and transmission guard can reduce the risk of damage to the vehicle's underbody and engine oil sump, for example when driving over kerbs, driveways or unsurfaced roads. If you wish to have one fitted, Volkswagen recommends contacting your Volkswagen dealership.

Additional information and warnings:



- Sitting correctly and safely → *Sitting correctly and safely*
- Transporting → *Transporting items*
- Starting the engine, changing gear and parking the vehicle → *Starting the engine, changing gear and parking*
- Driving with respect for the environment → *Driving with respect for the environment*
- Consumer information → *Consumer information*

WARNING


Driving under the influence of alcohol, drugs, medication or narcotics can cause serious accidents and fatal injuries.






- Alcohol, drugs, medication and narcotics can severely impair perception, reaction times and driving safety. This could cause you to lose control of the vehicle.

Preparing for a journey and driving safely

 First read and observe the introductory information and safety warnings →  *Introduction*

Checklist

Observe the following information both before and during every journey to ensure your own safety, and the safety of all passengers and other road users →  :

-  Check that all lights and turn signals are working properly.
-  Check the tyre pressure Wheels and tyres Tyres see Wheels and tyres_3 and fuel level Filling the tank Filling the tank .
-  Make sure that you have a good, clear view through all of the windows.
-  Air intake to the engine must not be obstructed, and the engine must not be covered with any kind of insulating materials .
-  Secure any objects and luggage in the stowage compartments, the luggage compartment or on the roof Transporting items Transporting items .

- ✓ Make sure that you are able to operate the pedals freely at all times.
- ✓ Secure any children travelling in the vehicle in a restraint system suitable for their weight and size Child seats Child seat ISOFIX see Child seat Top tether see Child seat .
- ✓ Adjust the front seats, head restraints and mirrors properly in accordance with the size of the occupants Adjusting the seat position Sitting .
- ✓ Wear shoes that provide good grip for your feet when using the pedals.
- ✓ The floor mat in the footwell on the driver side must leave the pedal area free and must be securely fastened.
- ✓ Assume a correct sitting position before setting off and maintain this position while driving. This also applies to all passengers Adjusting the seat position Sitting .
- ✓ Fasten your seat belt correctly before setting off and keep it properly fastened throughout the journey. This also applies to all passengers Seat belts Seat belts .
- ✓ Each vehicle occupant must sit in a seat of their own and must have their own seat belt.
- ✓ Never drive if your driving ability is impaired, e.g. by medication, alcohol or drugs.
- ✓ Do not allow yourself to be distracted from the traffic, e.g. by passengers, telephone calls, opening menus and making adjustments to settings.
- ✓ Always adapt your speed and driving style to suit visibility, weather, road and traffic conditions.
- ✓ Observe traffic regulations and speed limits.
- ✓ When travelling long distances, stop and take a break regularly – at least every 2 hours.
- ✓ Secure animals in the vehicle using a system that is suitable for their weight and size.



WARNING

Always observe current traffic regulations and speed limits, and think ahead when driving. Correct interpretation of a driving situation can make the difference between reaching your destination safely and having an accident with serious injuries.



Regular servicing of your vehicle not only maintains its value, it also ensures that your vehicle remains roadworthy and in working order.

Servicing work should therefore be carried out in accordance with the service schedule. Some work may have to be carried out before the due date of the next service if the vehicle is subjected to severe operating conditions. Severe operating conditions are, for example, frequent stop and go driving, frequent driving with a trailer and driving in areas with high levels of dust. Further information can be obtained from your Volkswagen dealership or qualified workshop.

Driving abroad



First read and observe the introductory information and safety warnings →  [Introduction](#)

Checklist

In some countries, special safety standards and emissions-related legislation apply that may differ from the construction of the vehicle, Volkswagen recommends that you visit your Volkswagen dealership before travelling abroad to find out about any legal requirements and the following issues at your destination:

- ✓ Does the vehicle need any technical modifications for driving abroad, e.g. masking or switching the headlights over?
- ✓ Are the necessary tools, diagnostic equipment and spare parts available for service and repair work?
- ✓ Are there any Volkswagen dealerships in the destination country?
- ✓ For petrol engines: is unleaded petrol with the correct octane number available?

- ✓ For diesel engines: is diesel with a low sulphur level available?
- ✓ Are the correct engine oil (Engine oil Engine oil Engine compartment Engine oil_3 Oil see Engine oil_3) and other service fluids that comply with Volkswagen specifications available in the destination country?
- ✓ Will the factory-fitted navigation system work with the navigation data available in the destination country?
- ✓ Are special tyres necessary for travelling in the destination country?


NOTICE

Volkswagen is not responsible for any vehicle damage caused by low-quality fuel, inadequate servicing work or lack of Genuine Parts.

Driving through water on roads

 First read and observe the introductory information and safety warnings →  [Introduction](#)

Please follow these rules to help prevent damage to your vehicle when driving through water, for example if the road is flooded:

- Check the depth of the water before driving through it. The water level must be **no higher** than the lower edge of the vehicle body → .
- Do not drive faster than walking speed.
- Never stop the vehicle, reverse or switch off the engine while in water.
- Oncoming vehicles create waves that could increase the water level for your vehicle to such an extent that it is not safe to drive through the water.
- When driving through water, always switch start/stop system off manually → [Pull-away assist systems](#) .

WARNING

After driving through water, mud, slush etc., the brakes may react slowly and the braking distance will be increased as the brake discs and pads will be wet, or possibly iced up in winter.

- You can dry and de-ice the brakes by performing careful braking manoeuvres. Make sure that you do not endanger any other road users or violate any legal regulations when doing so.
- Avoid abrupt and sudden braking manoeuvres directly after driving through water.

NOTICE

- If you drive through water, parts of the vehicle, such as the engine, drive train, running gear and vehicle electrics, could sustain severe damage.
- Never drive through salt water as salt can cause corrosion. Rinse all components that have been exposed to salt water immediately with fresh water.

Technical data

Introduction

This chapter contains information on the following subjects:

- [Vehicle identification data](#)
- [Engine data](#)
- [Dimensions](#)

→ *Performance figures*

The vehicle data sticker in the service schedule or the vehicle registration documents show which engine is installed in your vehicle.

All data in the official vehicle documents take precedence over these data. All the information provided in this manual applies to the basic model. The figures may be different if additional equipment is fitted, for different models, for special vehicles and for other countries.

Additional information and warnings:

- Transporting → *Transporting items*
- Driving with respect for the environment → *Driving with respect for the environment*
- Fuel → *Fuel*
- Engine oil → *Engine oil*
- Engine coolant → *Coolant*
- Wheels and tyres → *Wheels and tyres*
- Consumer information → *Consumer information*

⚠ WARNING

Ignoring or exceeding the values given for the weights, payloads, vehicle dimensions and maximum speed could lead to accidents and serious injuries.

Vehicle identification data

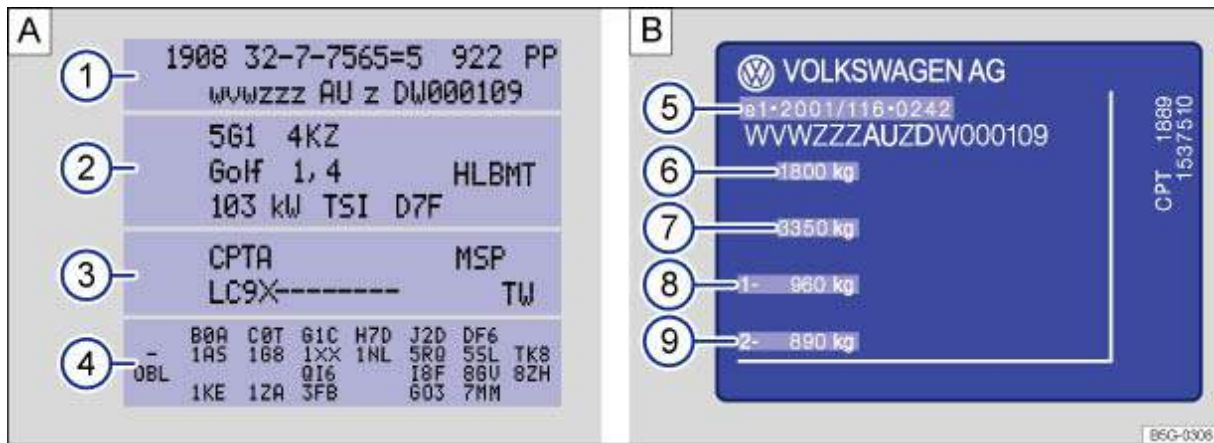


Fig. 19 A: vehicle data sticker: example shows a vehicle with engine code CPTA ③. B: type plate

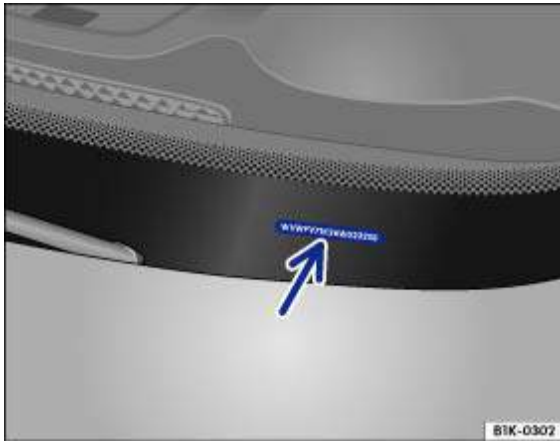






Fig. 20 Vehicle identification number

 **First read and observe the introductory information and safety warnings** →  *Introduction*

Vehicle identification number (VIN)

The vehicle identification number can be read from outside the vehicle through a viewer in the windscreen → *Fig. 20* (arrow). The viewer is located in the lower corner of the windscreen. The vehicle identification number is also stamped on the right water drain channel. The water drainage channel is located between the suspension turret and wing. You have to open the bonnet  to gain access to the vehicle identification number → *Preparation for working in the engine compartment* .

The vehicle identification number can be displayed in the infotainment system using the **CAR** button and the  and **Service** function buttons → *Menu and system settings (SETUP)* .

Vehicle data sticker

The vehicle data sticker → *Fig. 19 A* is in the spare wheel well area in the luggage compartment. It contains the following data:

- 1 Vehicle identification number (chassis number)
- 2 Vehicle type, engine power, gearbox type
- 3 Engine and gearbox code, paint number, interior equipment. In the example, the engine code is CPTA → *Fig. 19*.
- 4 Optional extras, PR numbers

These vehicle data are also contained in the service schedule.

Type plate

The type plate → *Fig. 19 B* can be seen on the lower part of the door pillar when the door is open. Vehicles for certain export countries do not have a type plate.


The type plate contains the following data:

- 5 Permission
- 6 Gross vehicle weight rating
- 7 Gross combination weight (vehicle plus trailer)

8 Gross axle weight rating, front

9 Gross axle weight rating, rear

Engine data

 **First read and observe the introductory information and safety warnings** →  *Introduction*

For reasons of vehicle registration and vehicle taxation, the power output and performance of some engines may vary in some countries from the information given in this booklet.

Petrol engines

Engine power	Injection technology	EC	Maximum torque	Cylinders Capacity
44 kW at 5,000 – 6,000 rpm		CHYA	95 Nm at 3,000 – 4,300 rpm	3 cylinders, 999 ccm
55 kW at 6,200 rpm		CHYB		
66 kW at 4,400 – 5,400 rpm	TSI®	CJZC	160 Nm at 1,400 – 3,500 rpm	4 cylinders, 1,197 ccm
81 kW at 4,600 – 5,600 rpm	TSI®	CJZD	175 Nm at 1,400 – 4,000 rpm	

Diesel engines

Engine power	Injection technology	EC	Maximum torque	Cylinders, Capacity
55 kW at 3,000 – 3,750 rpm	TDI®	CYZB	210 Nm at 1,500 – 2,000 rpm	3 cylinders, 1,422 ccm
		CUSA		
66 kW at 3500 rpm	TDI®	CUSB	230 Nm at 1,500 – 2,500 rpm	

Dimensions

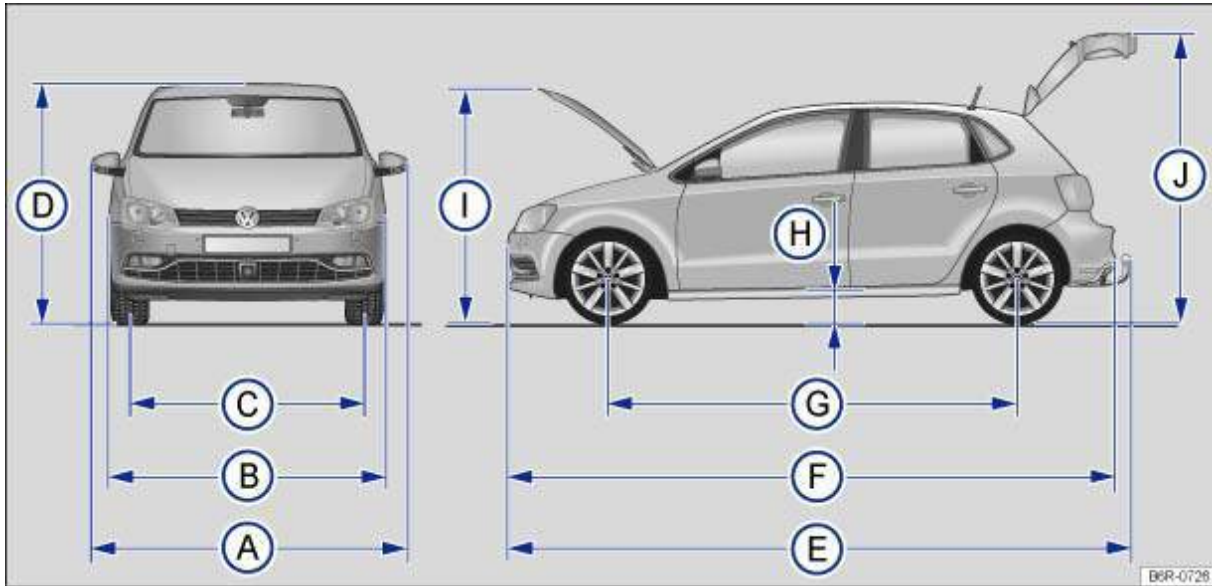


Fig. 21 Dimensions



First read and observe the introductory information and safety warnings → Introduction

The data in the table apply to the most basic German model.

The specified values can vary due to different tyre and wheel sizes, if additional equipment is fitted, for different model versions, for retrofitted accessories, and for special vehicles. They can also vary in vehicles that have been manufactured for other countries.

Key to → Fig. 21:		Polo	Polo BlueMotion	Cross Polo
Ⓐ	Width (from one exterior mirror to the other)	1,901 mm		
Ⓑ	Width	1,682 mm		1,698 mm
Ⓒ	Front track	1,441 mm – 1,465 mm	1,453 mm – 1,457 mm	1,438 mm – 1,460 mm
	Rear track	1,434 mm – 1,456 mm	1,446 mm – 1,450 mm	1,436 mm – 1,459 mm
Ⓓ	Height to the upper edge of the roof at kerb weight ^{a)}	1,453 mm	1,456 mm	1,474 mm
	Height at kerb weight ^{a)} with navigation aerial	1,461 mm	1,463 mm	1,480 mm
	Height to the upper edge of the roof at kerb weight ^{a)}	–	–	1,488 mm
Ⓔ	Length with fitted towing bracket (when factory-fitted)	4,064 mm – 4,074 mm	4,064 mm	4,077 mm
Ⓕ	Length (from bumper to bumper)	3,972 mm – 4,010 mm	3,970 mm	3,987 mm
Ⓖ	Wheelbase	2,456 mm	2,455 mm	2,459 mm
Ⓖ	Ground clearance when drive-ready ^{b)} between the axles	143 mm	145 mm	175 mm
Ⓘ	Height with open bonnet and kerb weight ^{a)}	1,759 mm	1,762 mm	1,783 mm
⓵	Height with open tailgate at kerb weight ^{a)}	2,000 mm	2,003 mm	2,019 mm
	Turning circle diameter	Approx. 10.6 m		

**NOTICE**

- Take care when driving in car parks with protruding kerbstones or bollards. Objects that protrude from the ground can damage the bumper and other components when parking the vehicle.
- Drive carefully through dips in the road, over driveways, ramps, kerbstones and other objects. Low-lying vehicle components such as the bumper, spoiler and parts of the running gear, engine or exhaust system could be damaged.

a) Kerb weight without driver, without payload.

b) Kerb weight with driver (75 kg) and service fluids.

Performance figures



First read and observe the introductory information and safety warnings → [Introduction](#)

For reasons of vehicle registration and vehicle taxation, the power output and performance of some engines may vary in some countries from the information given in this booklet.

Petrol engines

Engine power	EC	Gearbox type	Maximum speed
44 kW	CHYA	MG5	161 km/h ^{a)}
55 kW	CHYB		173 km/h ^{a)}
66 kW	CJZC		184 km/h ^{b)}
81 kW	CJZD	MG6	196 km/h ^{b)}

Diesel engines

Engine power	EC	Gearbox type	Maximum speed
55 kW	CYZB	MG5	173 km/h
	CUSA		
66 kW	CUSB	DSG [®] 7	184 km/h
			- ^{c)}



When the performance figures were measured, the vehicle was not fitted with any equipment that could reduce performance, e.g. a roof carrier or mud flaps.

a) Maximum speed is reached in 5th gear.

b) Maximum speed is reached in 4th gear.

c) Figures were not available at time of publication.

Opening and closing

Vehicle key set

Introduction

This chapter contains information on the following subjects:

- *Vehicle key*
- *Indicator lamp in the vehicle key*
- *Replacing the battery*
- *Synchronising the vehicle key*

Additional information and warnings:

- Settings in the Volkswagen information system → *Volkswagen information system*
- Central locking system → *Central locking system*
- Starting and stopping the engine → *Starting and stopping the engine*
- Consumer information → *Consumer information*
- Manual opening and closing → *Manual opening and closing*

DANGER

Swallowing batteries with a diameter of 20 mm, or other button cells, can result in severe or even fatal injuries within a very short period of time.

- Always keep the vehicle key, key ring with batteries, spare batteries, round cells and other batteries that are larger than 20 mm out of the reach of children.
- Call for medical help immediately you suspect that someone has swallowed a battery.

WARNING

Careless or unsupervised use of the vehicle key can lead to accidents or injuries.

- Always take all vehicle keys with you every time you leave the vehicle. Children or third parties could lock the doors and tailgate, start the engine or switch on the ignition and thus operate electrical equipment, such as the electric windows.
- Never leave children or people requiring assistance alone in the vehicle. They could become trapped in the vehicle in an emergency and may not be able to get themselves to safety. For example, locked vehicles may be subjected to very high or very low temperatures, according to season. This can cause serious injuries and illness or fatalities, especially for small children.
- Never remove the vehicle key from the ignition lock when the vehicle is in motion. The steering lock may be activated and you will no longer be able to steer the vehicle.

Vehicle key



Fig. 22 Vehicle key

First read and observe the introductory information and safety warnings →  [Introduction](#)

Vehicle key


The key can be used to lock and unlock the car from a distance → [Central locking system](#) .


The remote control transmitter and the battery are integrated in the key. The receiver is located in the vehicle interior. The remote control range is several metres around the vehicle when the battery is fully charged.

If the vehicle cannot be opened and closed using the vehicle key, the vehicle key will have to be re-synchronised → [Synchronising the vehicle key](#) , or the battery in the key replaced → [Replacing the battery](#) .

Several vehicle keys can be used.

Opening and closing the key bit

Press button → [Fig. 22](#)  to release the key bit and open it.

To *fold in*, press button  and simultaneously fold in the key bit until it clicks into place.

Replacement key

You will need to quote the vehicle chassis number when ordering a replacement key or additional remote control keys.

Each new key contains a microchip which must be encoded with the data for the vehicle's electronic immobilizer. The vehicle key will not work if it is not fitted with a microchip, or if the microchip has not been encoded. The same goes for keys that have been cut to fit the vehicle.

New keys or replacement keys are available from Volkswagen dealerships or from qualified workshops and authorised key services that are qualified to manufacture these vehicle keys.

New and replacement vehicle keys must be synchronised before use. Go to a qualified workshop.

**NOTICE**

Every vehicle key contains electronic components. Protect the key from damage, moisture and excessive vibration.



Press the buttons on the key only if the corresponding function is actually needed. Pressing a button when the function is not required could lead to the vehicle being unlocked unintentionally or the alarm going off. This also applies even when you are not within the effective range.



The function of the vehicle key can be affected temporarily if there is more than one transmitter in the direct vicinity working on the same frequency (e.g. a two-way radio or mobile telephone).



Obstacles between the key and the vehicle, bad weather conditions and weak batteries can reduce the range of the remote control.



If the buttons on the vehicle key → [Fig. 22](#) or one of the central locking buttons → [Central locking system](#) are pressed repeatedly within a short period of time, the central locking system will switch off briefly to prevent overloading. The vehicle will then be unlocked. Lock the vehicle if necessary.

Indicator lamp in the vehicle key



Fig. 23 Indicator lamp in the vehicle key

 **First read and observe the introductory information and safety warnings** →  *Introduction*

If a button on the vehicle key is pressed briefly, the indicator lamp → Fig. 23 (arrow) flashes once. The lamp will flash several times if the button is pressed and held, e.g. convenience opening.

If the indicator lamp in the key does not light up when a button is pressed, the battery in the key should be replaced → *Replacing the battery* .

Replacing the battery

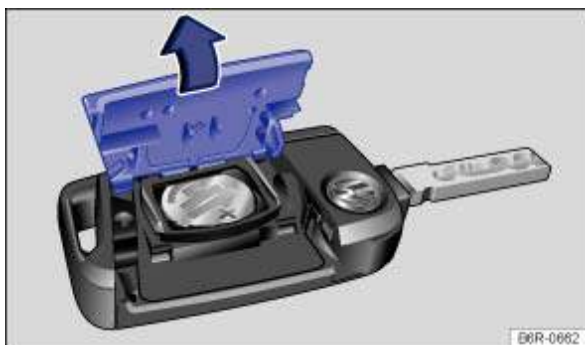


Fig. 24 Vehicle key: opening the battery compartment

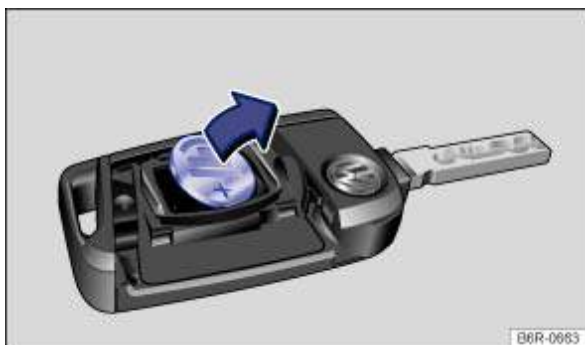






Fig. 25 Vehicle key: removing the battery

 **First read and observe the introductory information and safety warnings** →  *Introduction*

Volkswagen recommends having the battery changed at a Volkswagen dealership or by a qualified workshop.

The battery is located on the rear side of the vehicle key underneath a cover.

Replacing the battery

- Fold out the key bit of the vehicle key → *Opening and closing the key bit* .
- Pull up the cover on the rear side of the vehicle key → *Fig. 24* in the direction of the arrow → .
- Using a suitable thin object, lever the battery out of the battery compartment → *Fig. 25*.
- Insert the new battery as shown → *Fig. 25* and push it into the battery compartment against the direction of the arrow → .
- Fit the cover as shown → *Fig. 24* and push it onto the vehicle key housing against the direction shown by the arrow until it engages.

NOTICE

- **The vehicle key can be damaged if the battery is not changed properly.**
- **Unsuitable batteries can damage the vehicle key. Replace discharged batteries only with new batteries of the same voltage rating, size and specification.**
- **Make sure that the battery is fitted the right way round.**



Dispose of discharged batteries in accordance with regulations governing the protection of the environment.





The battery in the vehicle key may contain perchlorate. Please comply with any legal requirements and regulations when handling and disposing of these batteries.

Synchronising the vehicle key



First read and observe the introductory information and safety warnings →  *Introduction*

It may no longer be possible to lock or unlock the vehicle with the remote control if the  button is pressed repeatedly outside of the effective range of the vehicle key. If this is the case, the vehicle key should be re-synchronised as follows:

- Fold out the key bit of the vehicle key → *Opening and closing the key bit* .
- Press the  button on the vehicle key. Remain standing close to the vehicle.
- Unlock the vehicle with the key bit within one minute. The synchronisation process is complete.
- Fold in the key bit of the vehicle key.

Central locking system

Introduction

This chapter contains information on the following subjects:

- *Indicator lamp*
- *Description of the central locking system*
- *Locking and unlocking the vehicle from the outside*
- *Locking and unlocking the vehicle from the inside*
- *SAFELOCK mechanism*
- *Anti-theft alarm*
- *Interior monitoring system and anti-tow alarm*

The central locking system will only work correctly when all doors and the tailgate are properly closed. The vehicle *cannot* be locked with the key if the driver door is open.

If the vehicle is unlocked and not used for a long time (e.g. in your own garage) the vehicle battery could discharge or the engine may not start.

Additional information and warnings:

- Exterior views → [Exterior views](#)
- Infotainment system → [Infotainment system](#)
- Vehicle key set → [Vehicle key set](#)
- Doors → [Doors](#)
- Tailgate → [Tailgate](#)
- Electric windows → [Electric windows](#)
- Electric panorama sliding/tilting roof → [Electric panorama sliding/tilting glass roof](#)
- Mirrors → [Mirrors](#)
- Towing a trailer → [Towing a trailer](#)
- Cleaning and caring for the vehicle exterior → [Caring for and cleaning the vehicle exterior](#)
- Manual opening and closing → [Manual opening and closing](#)

**WARNING**

Improper use of the central locking system could lead to serious injury.

- The central locking system locks all doors. Locking the vehicle from the inside can prevent accidental opening of the doors and unauthorised persons from entering the vehicle. However, locked doors can delay assistance to passengers inside the vehicle in the event of an accident or emergency.
- Never leave children or people requiring assistance alone in the vehicle. All doors can be locked from the inside using the central locking button. This may mean that people lock themselves in the vehicle. People locked in the vehicle may be subjected to very high or very low temperatures.
- Temperatures inside a locked vehicle may reach extremes of heat or cold, according to season. This can cause serious injuries and illness or fatalities, especially to small children.
- Never leave anyone inside a locked vehicle. People in the vehicle could become trapped in an emergency and may not be able to get themselves to safety.

Indicator lamp

First read and observe the introductory information and safety warnings →  [Introduction](#)

The central locking system indicator lamp is located in the driver door → [Vehicle interior](#) .

Depending on the vehicle equipment level, the vehicle may have an anti-theft alarm and a SAFELOCK mechanism → [SAFELOCK mechanism](#) .

After locking the vehicle	Meaning	
	Without anti-theft alarm	With anti-theft alarm and SAFELOCK mechanism
A red LED flashes for approximately 2 seconds, firstly at short intervals and then more slowly.	Vehicle is locked.	Vehicle is locked and SAFELOCK is activated.
A red LED flashes for approximately 2 seconds and then goes out. The light starts to flash again after approximately 30 seconds.	–	Vehicle is locked and SAFELOCK is deactivated.
A red LED flashes for approximately 2 seconds in short		

intervals. The lamp will then light up without interruption for approximately 30 seconds.

Fault in the locking system. Go to a qualified workshop.

Fault in the locking system. Go to a qualified workshop.

NOTICE

Failure to observe the illuminated indicator lamps could lead to the vehicle being damaged.




Description of the central locking system



First read and observe the introductory information and safety warnings →  [Introduction](#)


The central locking system enables you to lock or unlock all the doors, the tailgate and tank flap from one central point:

- From outside the vehicle with the vehicle key → [Locking and unlocking the vehicle from the outside](#) .
- From inside the vehicle with the central locking button → [Locking and unlocking the vehicle from the inside](#) .

Certain central locking functions can be activated or deactivated in the infotainment system using the  button and the  and  function buttons → [Menu and system settings \(SETUP\)](#) , or the vehicle can be taken to a qualified workshop.

The doors, the tailgate and the tank flap can be locked or unlocked manually if the vehicle key or central locking system fails → [Manual opening and closing](#) .

Automatic locking (Auto Lock)

The vehicle may lock itself automatically at speeds of approximately 15 km/h (10 mph) and above → [Menu and system settings \(SETUP\)](#) . The indicator lamp  in the central locking button will light up yellow when the vehicle is locked → [Fig. 28](#) .

Automatic unlocking (Auto Unlock)

In some cases, the vehicle automatically unlocks all doors and the tailgate. This will happen in any of the following situations → [Menu and system settings \(SETUP\)](#) .

- The vehicle is at a standstill and the vehicle key has been removed.
- *In vehicles with an automatic gearbox:* the selector lever is in position **P** and the ignition has been switched off.
- In an accident, when airbags have triggered → [Manual opening and closing](#) .

Automatic unlocking gives emergency response crew access to the vehicle.



If the buttons on the vehicle key → [Fig. 26](#) or → [Fig. 27](#) or one of the central locking buttons → [Fig. 28](#) are pressed repeatedly within a short period of time, the central locking system will switch off briefly to prevent overloading. The vehicle is then unlocked for approximately 30 seconds. If the doors or the tailgate are not opened during this time the vehicle will lock again automatically.

Locking and unlocking the vehicle from the outside

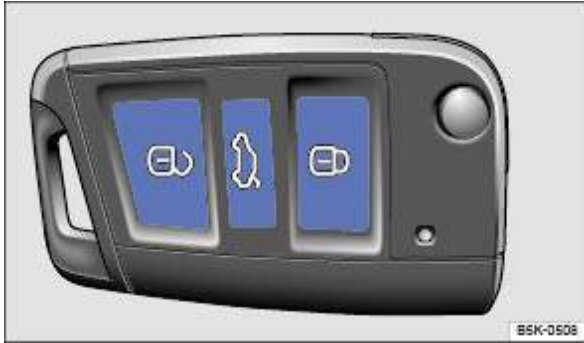


Fig. 26 Buttons on the vehicle key

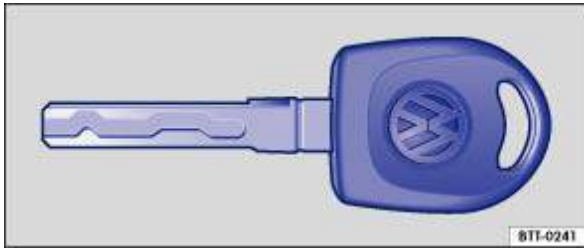





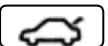



Fig. 27 Mechanical vehicle key

 First read and observe the introductory information and safety warnings →  [Introduction](#)

Function	Buttons to be used in the vehicle key → Fig. 26	Action to be followed with key in the lock cylinder → Fig. 26 or → Fig. 27
Unlocking the vehicle.	Press the  button. Press and hold for convenience opening.	Insert the vehicle key in the driver door lock cylinder and turn anticlockwise . Turn and hold for convenience opening.
Locking the vehicle.	Press the  button. Press and hold for convenience closing. In vehicles with a SAFELOCK mechanism, press the  button <i>once</i> to lock the vehicle using the SAFELOCK mechanism → SAFELOCK mechanism . Press the  button <i>twice</i> to lock the vehicle without the SAFELOCK mechanism.	Insert the vehicle key in the driver door lock cylinder and turn clockwise . Turn and hold for convenience closing.
Unlocking the tailgate.	Press the  button → Tailgate .	Insert the vehicle key in the driver door lock cylinder and turn anticlockwise .

Please note: depending on the central locking function that has been set in the infotainment system, all of the doors and the tailgate may only be unlocked when the  button is pressed twice → [Menu and system settings \(SETUP\)](#) .

The vehicle key will lock or unlock the vehicle only when the battery has enough power and the key is located within a few metres of the vehicle.

- When the vehicle is locked, all turn signals will flash *once* as confirmation.
- When the vehicle is unlocked, all turn signals will flash *twice* as confirmation.

If the turn signals *do not* flash as confirmation when the vehicle has been locked, at least one of the doors or the tailgate is not closed.

The vehicle cannot be locked using the vehicle key if the driver door is still open. The vehicle will lock again automatically within a few seconds of being unlocked if you do not open one of the doors or the tailgate. This function prevents the vehicle from remaining unlocked if the unlocking button is pressed by mistake.

Convenience opening and closing

- See: Electric windows – Functions → [Electric windows](#) .
- See: Function of the electric panorama sliding/tilting roof → [Electric panorama sliding/tilting glass roof](#) .



Depending on the mirror function set in the infotainment system, the exterior mirrors fold out again when the vehicle is unlocked using the



button → [Mirrors](#) .

Locking and unlocking the vehicle from the inside



Fig. 28 In the driver door: central locking button



First read and observe the introductory information and safety warnings → [Introduction](#)

Press the → Fig. 28 button:



Unlocks the vehicle.



Locks the vehicle.

The central locking button functions with the ignition switched on or off only when *all* doors are closed.

If the vehicle has been locked with the vehicle key, the central locking button does not work.

Please note the following when using the central locking button to lock the vehicle:

- The indicator lamp in the → Fig. 28 button lights up yellow when all doors are closed and locked.
- *In vehicles with SAFELOCK mechanism:* the SAFELOCK mechanism is **not** activated → [SAFELOCK mechanism](#) .
- The anti-theft alarm will **not** be activated.
- It is not possible to open the doors or tailgate from the *outside*, for instance when stopped at traffic lights.
- The doors can be unlocked and opened from the inside by pulling the door release handle. The indicator lamp in all doors switches off. You may have to pull the door release lever more than once. The unopened doors and tailgate remain locked and cannot be opened from the outside.

In some cases, the vehicle automatically unlocks all doors and the tailgate → [Menu and system settings \(SETUP\)](#) when:

- The button is pressed → Fig. 28.
- The vehicle comes to a standstill and the vehicle key is removed.
- A vehicle door is opened depending on the menu settings in the infotainment system → [Menu and system settings \(SETUP\)](#) .

SAFELOCK mechanism



First read and observe the introductory information and safety warnings → [Introduction](#)

Depending on the vehicle equipment level, the vehicle may have a SAFELOCK mechanism and an anti-theft alarm → [Anti-theft alarm](#) .

The SAFELOCK mechanism deactivates the door opening levers if the vehicle has been locked. This makes it more difficult to break into the vehicle. The doors can no longer be opened from the inside → .

Function	Action
Locking the vehicle and activating the SAFELOCK mechanism.	Press the button on the vehicle key <i>once</i> → Locking and unlocking the vehicle from the outside .
Locking the vehicle without activating the SAFELOCK mechanism.	Press the button on the vehicle key <i>twice</i> → Locking and unlocking the vehicle from the outside .
	Press the central locking button in the driver door <i>once</i> → Locking and unlocking the vehicle from the inside .
	Press the button for switching off the interior monitor and the anti-tow alarm <i>once</i> → Interior monitoring system and anti-tow alarm .

Depending on the vehicle equipment level, when the ignition is switched off, the instrument cluster display may inform you about the activated SAFELOCK mechanism (**SAFELOCK**).

Deactivating the SAFELOCK mechanism

The SAFELOCK mechanism can be deactivated in one of the following ways:

- Press the button on the vehicle key *twice*.
- Before locking the vehicle, press the button for switching off the interior monitor and anti-tow alarm *once* → [Interior monitoring system and anti-tow alarm](#) .
- Switch on the ignition.

The following applies when the SAFELOCK mechanism is deactivated:

- The vehicle can be unlocked and opened from the inside using the door release lever.
- The anti-theft alarm is active.
- The interior monitoring system and anti-tow alarm are deactivated.



WARNING

Take care when using the SAFELOCK mechanism to avoid accidents or injuries.

- **Never leave anybody in the vehicle if the vehicle has been locked using the vehicle key. The doors can no longer be opened from the inside once the SAFELOCK mechanism is activated.**
- **Locked doors make it more difficult for emergency service personnel to gain access to the vehicle and provide assistance when needed. In an emergency, people locked inside the vehicle would not be able to leave the vehicle by unlocking the doors.**

Anti-theft alarm



First read and observe the introductory information and safety warnings →  [Introduction](#)

Depending on the vehicle equipment level, the vehicle may have an anti-theft alarm and a SAFELOCK mechanism → [SAFELOCK mechanism](#) .

The anti-theft alarm makes it more difficult to break into the vehicle or steal it.

The anti-theft alarm is activated automatically when the vehicle is locked using the vehicle key.

When does the system trigger an alarm?

The anti-theft alarm will sound an acoustic alarm for approximately 30 seconds and trigger a visible warning for up to 5 minutes if any of the following unauthorised actions are performed while the vehicle is locked:

- *In vehicles with an open lock cylinder:* a door unlocked mechanically with the vehicle key is opened and the ignition is not switched on within approximately 15 seconds.
- *In vehicles with a covered lock cylinder:* a door unlocked mechanically with the vehicle key is opened.
- A door is opened.
- The bonnet is opened.
- The tailgate is opened.
- The ignition is switched on using an invalid key.
- The vehicle battery is disconnected.
- There is movement inside the vehicle (in vehicles with interior monitoring) → [Interior monitoring system and anti-tow alarm](#) .
- The vehicle is towed (vehicles with anti-tow alarm) → [Interior monitoring system and anti-tow alarm](#) .
- The vehicle is lifted (vehicles with anti-tow alarm) → [Interior monitoring system and anti-tow alarm](#) .
- The vehicle is transported on a car ferry or by rail (vehicles with anti-tow alarm or interior monitoring) → [Interior monitoring system and anti-tow alarm](#) .
- A trailer that is connected to the anti-theft alarm system is removed → [Towing a trailer](#) .

Switching off the alarm

Unlock the vehicle using the release button on the vehicle key or switch on the ignition using a valid vehicle key.



The alarm will be triggered again if a person gains access to the same or a different secured zone after the alarm has been switched off.

For example, if the tailgate is opened after a door had been opened.



The anti-theft alarm will **not** be activated if the vehicle is locked from the inside using the central locking button  .



If you unlock the driver door mechanically using the vehicle key, only the driver door is unlocked, and not the whole vehicle. The SAFELOCK mechanism on all doors is not deactivated and the central locking button is not activated until you switch on the ignition (however the doors will not be unlocked).



The anti-theft alarm will not function correctly if the vehicle battery is weak or discharged.

[Interior monitoring system and anti-tow alarm](#)



Fig. 29 Next to the driver seat: button for switching off the interior monitoring system and anti-tow alarm



Fig. 30 In the roof console: sensors for the interior monitoring system (arrows)





First read and observe the introductory information and safety warnings →  [Introduction](#)

The interior monitoring system will trigger an alarm if movement is detected inside the vehicle when the vehicle is locked.


The anti-tow alarm will be triggered if the vehicle is lifted.


Switching on the interior monitoring system and anti-tow alarm

Lock the vehicle using the vehicle key. When the anti-theft alarm is switched on, the interior monitoring system and the anti-tow alarm are also active.

When interior monitoring and the anti-tow alarm have been deactivated by pressing the  button → [Fig. 29](#), these functions can be reactivated by pressing the  button again. The yellow indicator lamp goes out.

Switching off the interior monitoring system and anti-tow alarm

The orientation lighting in the button  must be lit up when switching the systems off → [Fig. 29](#). To switch the orientation lighting on, remove the vehicle key from the ignition lock and open the driver door.

- Press the  button → [Fig. 29](#). A yellow indicator lamp will light up in the button until the vehicle is locked.
- Close all doors and the tailgate.
- Lock the vehicle using the vehicle key. The interior monitoring system and anti-towing alarm are switched off until the next time the vehicle is locked.

The interior monitoring system and anti-tow alarm should therefore be switched off before the vehicle is locked in any of the following, or similar, situations:

- If any people or animals are to remain inside the vehicle for a short period.
- If the vehicle is to be loaded onto another vehicle.
- If the vehicle is being transported (e.g. on a ferry).
- If the vehicle is going to be towed with one axle off the ground.
- If the vehicle is to be parked in a two-storey garage.
- If the vehicle is to be parked in a car wash.

Risk of false alarm

Interior monitoring can only work properly if the vehicle is completely closed. Comply with legal regulations. A false alarm can be triggered in any of the following circumstances:

- If one or more windows are fully or partly open.
- If the electric panorama sliding/tilting roof is fully or partly open.
- If lightweight items such as loose pieces of paper or items hung from the interior mirror (e.g. air-fresheners) are left in the vehicle.
- If a mobile telephone that is left in the vehicle vibrates.
- If the vehicle is being transported (e.g. on a ferry).
- If the vehicle is being parked in a two-storey garage.
- If the vehicle is in a car wash.



If doors or the tailgate are still open when the anti-theft alarm is activated, only the anti-theft alarm is activated. Interior monitoring and the anti-tow alarm are not activated until all doors and the tailgate are closed.



The SAFELOCK mechanism is deactivated when the interior monitor and anti-tow alarm are switched off → [SAFELOCK mechanism](#) .

Doors

Introduction

This chapter contains information on the following subjects:

- [Warning lamp](#)
- [Childproof lock](#)

Additional information and warnings:

- Exterior views → [Exterior views](#)
- Vehicle key set → [Vehicle key set](#)
- Central locking system → [Central locking system](#)
- Manual opening and closing → [Manual opening and closing](#)

⚠ WARNING

Any door that is not properly closed could open suddenly while the vehicle is in motion. This could lead to severe injuries.

- Stop as soon as possible and close the door.
- Make sure that the door is closed properly and that the lock has engaged. The closed door must be flush with the surrounding body panels.
- Doors should only be opened or closed when you are sure there is no-one in their path.



⚠ WARNING

Any door being held open by the door arrester could close unexpectedly in strong winds or if the vehicle is on a slope. This could lead to injuries.


- Always keep a good grip on the handle when opening and closing doors.

Warning lamp

 First read and observe the introductory information and safety warnings →  [Introduction](#)

Lit up	Possible cause	Action
	At least one vehicle door is opened or not properly closed.	 Do not drive on! Open the appropriate vehicle door and then close it again.

Several warning and indicator lamps will light up briefly as a functional check when the ignition is switched on. They will go out after a few seconds.

A warning lamp  appears in the instrument cluster display if a door is open or not properly closed.

Childproof lock

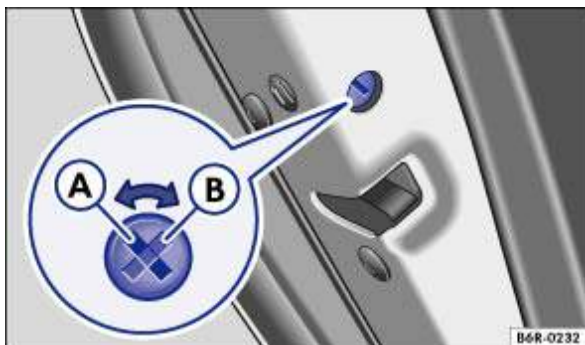


Fig. 31 In the left rear door: childproof lock (A) switched off, (B) switched on

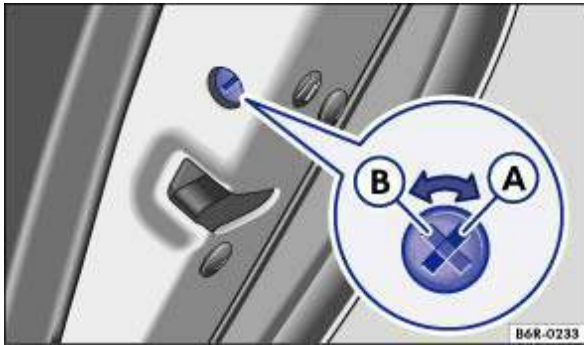


Fig. 32 In the right rear door: childproof lock (A) switched off, (B) switched on



First read and observe the introductory information and safety warnings →  [Introduction](#)

The childproof lock prevents the rear doors from being opened from the inside, e.g. so that children cannot open the doors accidentally while the vehicle is in motion. When the childproof lock is activated the door can only be opened from the outside.

Switching the childproof lock on and off

- Unlock the vehicle and open the appropriate rear door.
- Fold the key bit out of the vehicle key → [Vehicle key set](#) .
- Use the key bit to turn the slot to the required position.

Slot position → [Fig. 31](#) or → [Fig. 32](#):



Childproof lock is switched off.



Childproof lock is switched on.



WARNING

When the childproof lock is activated, the door cannot be opened from the inside.

- Never leave children or people requiring assistance alone in the vehicle when the doors are locked. This may mean that these people lock themselves in the vehicle. They could become trapped in the vehicle in an emergency and may not be able to get themselves to safety. People locked in the vehicle may be subjected to very high or very low temperatures.
- Temperatures inside a locked vehicle may reach extremes of heat or cold, according to season. This can cause serious injuries and illness or fatalities, especially to small children.

Tailgate



Introduction

This chapter contains information on the following subjects:

- [Warning lamp](#)
- [Opening the tailgate](#)
- [Closing the tailgate](#)

Additional information and warnings:

- Exterior views → [Exterior views](#)
- Central locking system → [Central locking system](#)

- Transporting → [Driving tips](#)
- Manual opening and closing → [Manual opening and closing](#)

WARNING

Incorrect and unsupervised unlocking, opening or closing of the tailgate can cause accidents and serious injuries.

- Therefore the tailgate should only be opened or closed when you are sure there is no-one in its path.
- Never close the tailgate by pushing it down with your hand on the window. The rear window could shatter and cause injuries.
- After closing the tailgate, check to make sure that it is closed and locked correctly so that it does not open while the vehicle is in motion. The closed tailgate must be flush with the surrounding body panels.
- Always keep the tailgate closed while the vehicle is in motion so that no toxic exhaust fumes can enter the vehicle interior.
- Never open the tailgate if there is a load attached to it, e.g. a rack or luggage carrier. It may also not possible to open the tailgate if there are objects attached to it, e.g. bicycles. The additional load might cause the open tailgate to close by itself. Support the tailgate as necessary or remove the load from the surface.
- Close and lock the tailgate and all vehicle doors when the vehicle is not in use. Make sure there is no-one left in the vehicle.
- Never leave children playing unattended in or around the vehicle, especially when the tailgate is open. Children could climb into the luggage compartment and shut the tailgate, thereby trapping themselves inside. Temperatures inside a locked vehicle may reach extremes of heat or cold, according to season. This can cause serious injuries and illness or fatalities, especially to small children.

NOTICE

Before opening the tailgate, please check that there is enough space to open and close the tailgate, e.g. when towing a trailer or when in a garage.



NOTICE

Never use the gas-filled strut or the rear spoiler (depending on the equipment level of the vehicle) to fix or hold a load. This could result in damage preventing closure of the tailgate, or could even lead to the rear spoiler being ripped off.


Warning lamp



First read and observe the introductory information and safety warnings →  [Introduction](#)

Lit up	Possible cause	Action
	The tailgate is open or not properly closed.	 Do not drive on! Open the tailgate and close it again.

Several warning and indicator lamps will light up briefly as a functional check when the ignition is switched on. They will go out after a few seconds.

A warning lamp  appears in the instrument cluster display if the tailgate is open or not properly closed.

WARNING

If the tailgate is not properly closed it could open suddenly while the vehicle is in motion. This could lead to severe injuries.

- Stop as soon as possible and close the tailgate.
- After closing the tailgate, always check that it is properly secured.

Opening the tailgate



Fig. 33 In the vehicle key: button for unlocking and opening the tailgate

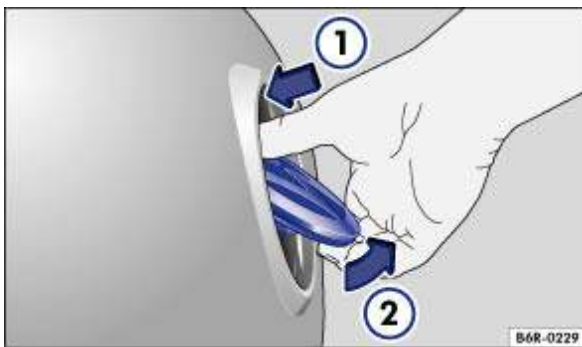





Fig. 34 Opening the tailgate from the outside

 First read and observe the introductory information and safety warnings →  *Introduction*

Before opening the tailgate, always remove any items of luggage that are on the luggage carrier attached to the tailgate → .

Unlocking with the vehicle key

- Press the  button in the vehicle key → Fig. 33 for approximately one second to unlock the tailgate.
- **OR:** press and hold down the  button until the tailgate has opened a few centimetres automatically.
- Open the tailgate using the Volkswagen badge → *Opening with the Volkswagen emblem* .

Opening with the Volkswagen emblem

- Unlock the vehicle or tailgate or open one of the doors.
- Press the top part of the Volkswagen badge with your thumbs → Fig. 34 ① and push out the bottom part with your fingers ②.
- With your hand under the Volkswagen badge, lift up and open the tailgate. Once it reaches a certain angle, the tailgate will open by itself.

**WARNING**

Serious injuries can occur if the tailgate is unlocked or opened incorrectly or without due care and attention.

- It may not always be apparent that the tailgate is unlocked, for example when a loaded luggage carrier is attached to it. If unlocked, the tailgate may open suddenly while the vehicle is in motion.



At outside temperatures lower than around 0°C (+32°F), the opening mechanism cannot always lift the partially opened tailgate automatically. The tailgate then has to be guided further up by hand.

Closing the tailgate

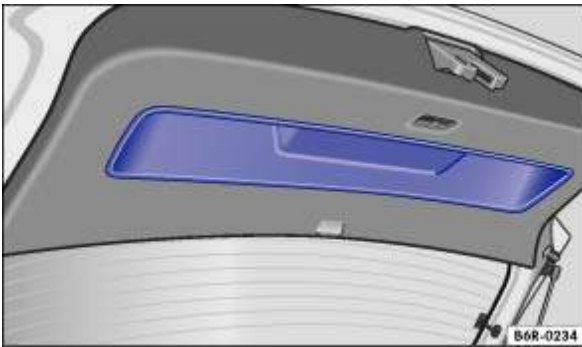


Fig. 35 Open tailgate: handle recesses for closing the tailgate



First read and observe the introductory information and safety warnings →  *Introduction*


Closing the tailgate

- Grip one of the recesses in the interior trim of the tailgate → Fig. 35.
- Pull the tailgate down with some force until it engages in the lock.
- Pull the tailgate to make sure that it is engaged securely.

Locking the tailgate

The vehicle will be locked again if you do not open one of the doors or the tailgate within a few seconds automatically after unlocking the car. This function prevents the vehicle from remaining unlocked if the unlocking button is pressed by mistake.

The tailgate can only be locked when it is properly closed and engaged.

- The tailgate is also locked by the central locking system.
- If the tailgate of a locked vehicle is unlocked using the  button in the vehicle key, it will lock again approximately 20 seconds after it is closed. The anti-theft alarm is activated immediately after it is closed → *Central locking system* .
- If the tailgate is closed but not locked, it will lock automatically once the vehicle reaches a speed of approximately 9 km/h (6 mph).

**WARNING**

Serious injuries can occur if the tailgate is closed incorrectly or without due care and attention.

- Never leave children playing unattended in or around the vehicle, especially when the tailgate is open. Children could climb into the luggage compartment and shut the tailgate, thereby trapping themselves inside. Temperatures inside a locked vehicle may reach extremes of heat or cold, according to season. This could cause serious injuries or illness, or even have fatal consequences.



Before closing the tailgate, check that the vehicle key is not in the luggage compartment.

Electric windows

Introduction

This chapter contains information on the following subjects:

- *Opening or closing the windows electrically*
- *Electric windows – functions*
- *Roll-back function for the electric windows*

Additional information and warnings:

- Volkswagen information system → *Volkswagen information system*
- Infotainment system → *Infotainment system*
- Central locking system → *Central locking system*
- Cleaning and caring for the vehicle exterior → *Caring for and cleaning the vehicle exterior*

**WARNING**

Careless or unsupervised use of the electric windows can cause serious injuries.

- The electric windows should only be opened or closed when you are sure that nobody is in their operating area.
- Never leave children or people requiring assistance alone in the vehicle when the vehicle is locked. The windows can no longer be opened in an emergency.
- Always take all vehicle keys with you every time you leave the vehicle. The windows can still be operated using the buttons several minutes after the ignition has been switched off, provided that the driver door and front passenger door are not opened.
- When transporting children on the rear bench seat, the rear electric windows should always be deactivated using the safety button so that they cannot be opened or closed.

**NOTICE**

During sudden rain showers, water can enter the vehicle interior via open windows and cause damage to the vehicle.

Opening or closing the windows electrically

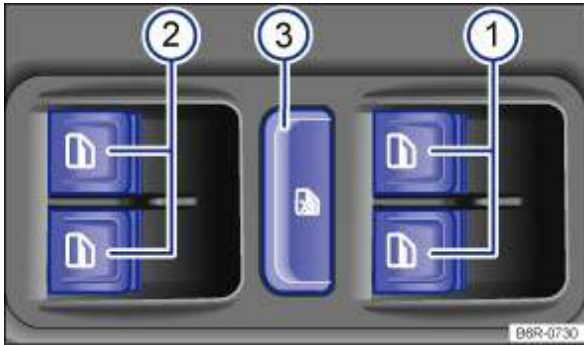


Fig. 36 In the driver door: buttons for the front and rear electric windows with one-touch opening and closing

First read and observe the introductory information and safety warnings → [Introduction](#)

Buttons in the driver door with one-touch opening and closing

Key to → [Fig. 36](#):

- 1** Buttons for the windows in the front doors.
- 2** Buttons for the windows in the rear doors.
- 3** Safety button for switching the electric childproof lock on and off.

Opening and closing windows with one-touch opening and closing

Function	Action
Opening	Press the button.
Closing	Pull the button.
Stopping the one-touch function	Press or pull the button for the appropriate window again.
	The safety switch → Fig. 36 3 deactivates the electric window buttons in the rear doors. The yellow indicator lamp in the button will light up.

The electric windows will only function when the ignition is switched on.

The windows can still be operated using the buttons several minutes after the ignition has been switched off, provided that the driver door and front passenger door are not opened. If the vehicle key is removed from the ignition lock and the driver door is opened, all electric windows can be opened or closed by operating and holding the corresponding window button in the driver door. After a few seconds, convenience opening/closing is started → [Convenience opening and closing](#) .

Electric windows – functions

First read and observe the introductory information and safety warnings → [Introduction](#)

One-touch opening and closing

One-touch opening and closing makes it possible to fully open and close the windows. The individual buttons do not have to be held down to do this.

For one-touch closing: pull the button for the appropriate window up briefly into the second position.

For one-touch opening: press the button for the appropriate window down briefly into the second position.

Stopping the one-touch function: press or pull the button for the appropriate window again.

Restoring one-touch opening and closing

One-touch opening and closing is deactivated if the vehicle battery has been disconnected or discharged while the windows were not fully closed. The function will have to be reset.

- Close all windows and doors.
- Pull up the button for the window and hold it in this position for at least one second.
- Let go of the button then pull it up again and hold it in this position. One-touch opening and closing is now ready for operation.

The one-touch function can be restored for individual windows or for several windows at the same time.

Convenience opening and closing

The windows can be opened and closed from outside the vehicle using the vehicle key:

- Press and hold the locking or unlocking button on the vehicle key. All electric windows will be either opened or closed.
- To interrupt this function, let go of the locking or unlocking button.

During convenience closing, first the windows and then the electric panorama sliding/tilting glass roof.



WARNING

Careless or unsupervised use of the electric windows can cause serious injuries.

- The electric windows should only be opened or closed when you are sure that nobody is in their operating area.
- Never leave children or people requiring assistance alone in the vehicle when the vehicle is locked. The windows can no longer be opened in an emergency.
- Always take all vehicle keys with you every time you leave the vehicle. The windows can still be operated using the buttons several minutes after the ignition has been switched off, provided that the driver door and front passenger door are not opened.
- When transporting children on the rear bench seat, the rear electric windows should always be deactivated using the safety button so that they cannot be opened or closed.




One-touch opening and closing and the roll-back function will not work if there is a fault in the electric windows. Go to a qualified workshop.


Roll-back function for the electric windows



First read and observe the introductory information and safety warnings →  [Introduction](#)

The roll-back function for the electric windows can reduce the risk of injuries when the windows are closing → . If the one-touch closing function for a window does not work because it is stiff or is being obstructed, the window will automatically open again.

- Check to see why the window has not closed.
- Try to close the window again.

- If the window is again prevented from closing within approximately 10 seconds of the first attempt because it is stiff or obstructed, the automatic closing function is switched off for approximately 10 seconds.
- If the window is still obstructed, the window stops at this point. To close the window without the **roll-back function**, press the button again within 10 seconds → .

Closing the window without the roll-back function

- Try to close the window again within approximately 10 seconds by holding the button. **The roll-back function will be deactivated for a small section of the path of the closing window.**
- If the closing procedure takes longer than approximately 10 seconds, the roll-back function will be reactivated. The window will then stop again if it is stiff or meets another obstacle.
- Please go to a qualified workshop if the window still cannot be closed.



WARNING

Closing the electric windows without the roll-back function could lead to severe injuries.

- **Always take care when closing electric windows.**
- **Ensure that nobody obstructs the path of the electric windows, especially if the roll-back function is not active.**
- **The roll-back function does not prevent fingers or other body parts from being pressed against the window frame and sustaining injury.**



The roll-back function is also activated if the windows are closed using the vehicle key for convenience closing → [Convenience opening and closing](#) .

Electric panorama sliding/tilting glass roof

Introduction

This chapter contains information on the following subjects:

- [Opening and closing the electric panorama sliding/tilting glass roof](#)
- [Electric panorama sliding/tilting glass roof – function](#)
- [Roll-back function of the electric panorama sliding/tilting glass roof](#)

Additional information and warnings:

- Infotainment system → [Infotainment system](#)
- Central locking system → [Central locking system](#)
- Roof carrier → [Roof carrier](#)
- Manual opening and closing → [Manual opening and closing](#)

⚠ WARNING

Always take care when using the electric panorama sliding/tilting glass roof; otherwise you could cause accidents or serious injuries.

- The electric panorama sliding/tilting glass roof should only be opened or closed when you are sure that nobody is in its operating area.
- Always take all vehicle keys with you every time you leave the vehicle.
- Never leave children or people requiring assistance alone in the car, particularly if they have access to the vehicle key. Unsupervised use of the vehicle key can result in the vehicle being locked, the engine being started, the ignition being switched on and the electric panorama sliding/tilting glass roof being operated.
- The electric panorama sliding/tilting glass roof can be operated for a short time after the ignition has been switched off, provided the driver door or the front passenger door is not opened.

ⓘ NOTICE

- In cold conditions, remove any ice and snow from the roof of the vehicle before you open or tilt the electric panorama sliding/tilting glass roof to avoid the risk of damage.
- The electric panorama sliding/tilting glass roof should always be closed before you leave the vehicle or if it starts to rain. Any rain entering the vehicle when the electric panorama sliding/tilting glass roof is open could cause considerable damage to the electrical system. This can result in further damage to the vehicle.



If there is a fault in the electric panorama sliding/tilting roof, the roll-back function will not work properly. Go to a qualified workshop



Leaves and other loose objects must be removed from the guide rails of the electric panorama sliding/tilting glass roof at regular intervals, using a vacuum cleaner or by hand.

Opening and closing the electric panorama sliding/tilting glass roof

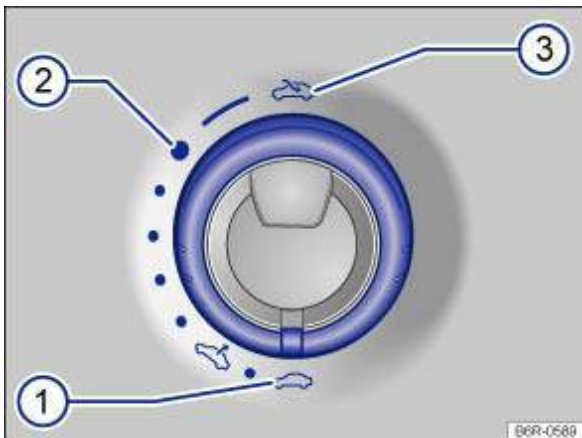


Fig. 37 In the roof: turn the switch to open and close

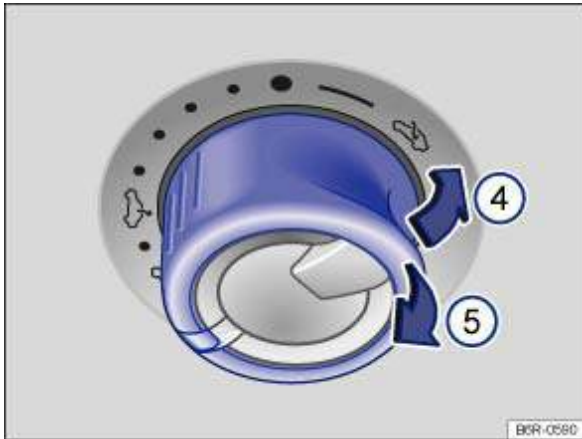


Fig. 38 In the headliner: push the switch to tilt and pull the switch to close



First read and observe the introductory information and safety warnings →  *Introduction*

The rotary switch must be in the basic position ① before the electric panorama sliding/tilting glass roof can be tilted.

Function	→ Fig. 37 and → Fig. 38	Action
Opening sliding roof completely	③	Turn the switch past the position ② and hold down until the glass roof has reached the required position.
Moving sliding roof to convenience position	②	Turn the switch to the required position.
Setting an intermediate position	② to ①	
Closing sliding roof completely	①	
Tilting the tilting roof completely	④	Push the switch back briefly.
Stopping the one-touch function	④ or ⑤	Press or pull the switch again briefly.
Closing fully	⑤	Pull the switch back briefly.

The electric panorama sliding/tilting roof will work only when the ignition has been switched on. The electric panorama sliding/tilting glass roof can be operated for a short time after the ignition has been switched off, provided the driver door or the front passenger door is not opened.

If the closing procedure has been started, it will be interrupted as soon as the ignition is switched off and the switch for the electric panorama sliding and tilting glass roof is activated.

If it is not possible to close the electric panorama sliding/tilting glass roof electrically you will have to close it manually. You will not be able to close the electric panorama sliding/tilting glass roof manually without first removing some vehicle components. Go to a qualified workshop.

Sliding blind

Use the handle at the front near the roof opening to move the sliding blind to the required position.



The convenience position allows sufficient air supply together with low wind noise.

Electric panorama sliding/tilting glass roof – function






First read and observe the introductory information and safety warnings →  *Introduction*

Convenience opening and closing

The electric panorama sliding/tilting glass roof can be opened and closed from the outside with the vehicle key.

- Press and hold the locking or unlocking button on the vehicle key. The electric panorama sliding/tilting roof is tilted or closed.
- Let go of the lock or unlock button to interrupt this function.

During convenience closing, first the windows and then the electric panorama sliding/tilting glass roof.

A variety of settings related to window operation can be made and adjusted using the  button and the  and  function buttons → *Menu and system settings (SETUP)* .



The rotary control of the electric panorama sliding/tilting glass roof remains in the last position selected if the roof is closed from outside the vehicle using convenience closing. It will have to be re-positioned the next time you drive.




In special driving situations, for example, oversteering or understeering, the open electric panorama sliding/tilting glass roof can be automatically closed to a small gap at speeds of approx. 30 km/h (18 mph).

Roll-back function of the electric panorama sliding/tilting glass roof




First read and observe the introductory information and safety warnings →  *Introduction*

The roll-back function can reduce the risk of injury when the electric panorama sliding/tilting glass roof is being closed →  . If the electric panorama sliding/tilting glass roof is not able to close because it is stiff or obstructed, it will automatically open again immediately.

- Check why the electric panorama sliding/tilting glass roof has not closed.
- Try to close the electric panorama sliding/tilting glass roof again.
- If the electric panorama sliding/tilting glass roof is still stiff or obstructed, it stops at this point. Then close the electric panorama sliding/tilting glass roof without the roll-back function

Closing the electric panorama sliding/tilting glass roof without the roll-back function

- Pull the switch → *Fig. 38*  within approximately 5 seconds after the roll-back function has been triggered and hold it in this position until the electric panorama sliding/tilting glass roof is closed completely.
- **The electric panorama sliding/tilting glass roof will then close without the roll-back function.**
- If the electric panorama sliding/tilting glass roof still cannot be closed, go to a qualified workshop.

If you let go of the switch during the closing procedure, the electric panorama sliding/tilting glass roof will open automatically.



WARNING

Closing the electric panorama sliding/tilting glass roof without the roll-back function can cause severe injuries.

- **Always be careful when closing the electric panorama sliding/tilting glass roof.**
- **Ensure that nobody is obstructing the operating area of the electric panorama sliding/tilting glass roof, especially if the roll-back function is not active.**
- **The roll-back function does not prevent fingers or other body parts from being pressed against the roof frame and sustaining injury.**



The roll-back function is also active if the windows and electric panorama sliding/tilting glass roof are closed with the vehicle key

→ *Convenience opening and closing* .

Sitting correctly and safely

Adjusting the seat position

Introduction

This chapter contains information on the following subjects:

- *The dangers of assuming an incorrect sitting position*
- *Correct sitting position*
- *Mechanical controls on the front seats*
- *Adjusting the head restraints*
- *Removing and fitting head restraints*
- *Adjusting the steering wheel position*
- *Centre armrest*

Number of seats

The vehicle has a total of **5** seats: 2 at the front and 3 at the rear. Each seat is equipped with a seat belt.

Additional information and warnings:

- Seat functions → *Seat functions*
- Seat belts → *Seat belts*
- Airbag system → *Airbag system*
- Child seats → *Child seats*
- Cleaning and caring for the interior → *Cleaning and caring for the interior*



WARNING

Assuming an incorrect sitting position in the vehicle can increase the risk of severe or fatal injuries during a sudden driving or braking manoeuvre, in the event of a collision or accident, or if the airbags are triggered.

- All vehicle occupants must assume a correct sitting position before setting off and maintain this position throughout the trip. This also applies to the fastening of seat belts.
- The number of vehicle occupants must never exceed the number of seats with seat belts in the vehicle.
- Always secure children in the vehicle in an authorised restraint system which is suitable for their height and weight → *Airbag system* , → *Child seats* .
- Always keep your feet in the footwell while the vehicle is in motion. Never place your feet on the seat or dash panel, for example, and never ride with your feet out the window. When you are sat like this, the airbag and seat belt cannot provide optimal protection and could actually increase the risk of injury during an accident.

**WARNING**

Always adjust seats, seat belts and head restraints to their correct position before any journey and ensure that all passengers have fastened their seat belt.

- Push the front passenger seat as far back as possible.
- Adjust the driver seat so that there is at least 25 cm between your breastbone and the hub of the steering wheel. If your physical build makes it impossible to fulfil this requirement, you must contact a qualified workshop so they can make any necessary modifications.
- Never travel with the backrest tilted far back. The further back the backrest is tilted, the greater the risk of injury caused by incorrect seat belt routing or an incorrect sitting position.
- Never travel with the backrest tilted far forwards. When a front airbag is triggered it could force the seat backrest backwards and injure vehicle occupants on the back seats.
- Adopt and maintain the greatest possible distance from the steering wheel and dash panel.
- You should always sit upright with your back against the seat backrest with the front seats properly adjusted. Do not position any body part too close where the airbags are fitted.
- The risk of serious injury is increased for passengers on the rear seat if they are not sitting upright because the seat belts are incorrectly positioned.

**WARNING**

Incorrect adjustment of the seats can cause accidents and serious injuries.

- The seats may only be adjusted when the vehicle is stationary, or else the seat could change position unexpectedly while the vehicle is in motion, leading to a loss of control of the vehicle. Furthermore, an incorrect seating position is adopted while adjusting the seat.
- Only adjust the height and tilt of the seat or move it forwards and backwards when the area around the seat is clear.
- There should be no objects in the adjustment area of the front seats.

**WARNING**

Cigarette lighters in the vehicle could be damaged or accidentally lit. This could lead to serious burns and other injuries.

- Before adjusting the seats always make sure that there is no lighter on or near the moveable parts of the seat.
- Before closing stowage areas or compartments always make sure that there is no lighter in the way.
- Never stow lighters in stowage areas or compartments or on other surfaces in the vehicle. Cigarette lighters may self-ignite on high-temperature surfaces, especially in summer.

The dangers of assuming an incorrect sitting position



First read and observe the introductory information and safety warnings →  [Introduction](#)

If the seat belts are not worn or are worn incorrectly, the risk of severe or fatal injuries increases. Seat belts can only provide optimal protection if the seat belt routing is correct. Assuming an incorrect sitting position considerably impairs the level of protection provided by a seat belt. This could lead to severe or even fatal injuries. The risk of severe or fatal injuries is especially increased when a deploying airbag strikes a vehicle occupant who has assumed an incorrect sitting position. The driver is responsible for all occupants transported in the vehicle, especially children.

The following list contains examples of sitting positions that can be dangerous for all vehicle occupants.

Whenever the vehicle is in motion:

- Never stand in the vehicle.
- Never stand on the seats.
- Never kneel on the seats.
- Never tilt the backrest too far to the rear.
- Never lean against the dash panel.
- Never lie on the rear bench seat.
- Never sit on the front edge of a seat.
- Never sit sideways.
- Never lean out of a window.
- Never put your feet out of a window.
- Never put your feet on the dash panel.
- Never place your feet on the seat cushion or seat backrest.
- Never travel in a footwell.
- Never sit on the front armrest.
- Never travel on a seat without wearing the seat belt.
- Never travel in the luggage compartment.

**WARNING**

Every incorrect sitting position in the vehicle increases the risk of severe or fatal injuries in the event of an accident or sudden driving or braking manoeuvre.

- All vehicle occupants must maintain a correct sitting position and wear their seat belt properly while the vehicle is in motion.
- Sitting in an incorrect position, not fastening the seat belt, or being too close to the airbag exposes the occupants to the risk of sustaining critical or fatal injuries, especially if the airbags are triggered and strike an occupant who has assumed an incorrect sitting position.

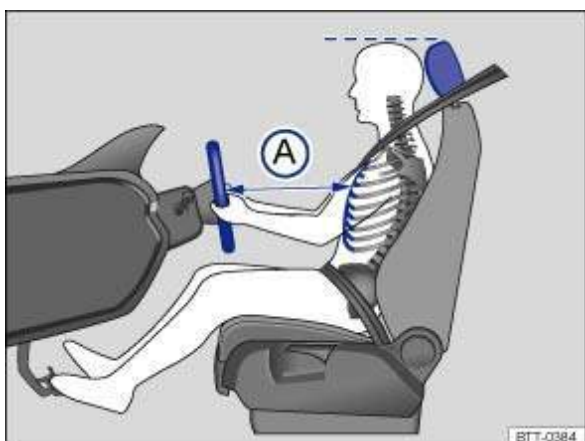
Correct sitting position

Fig. 39 There must be a distance (A) of at least 25 cm between the driver and the steering wheel

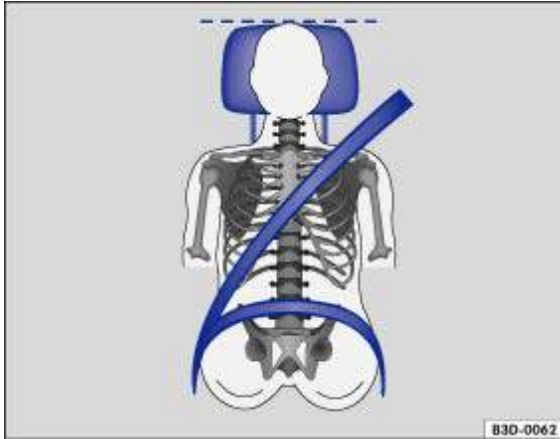


Fig. 40 Correct seat belt routing and head restraint adjustment



First read and observe the introductory information and safety warnings →  *Introduction*

The following details the correct sitting positions for the driver and passengers.

If any vehicle occupants cannot assume a correct sitting position due to their physical build, they should contact a qualified workshop to find out about possible special modifications. The seat belts and airbags can only provide a maximum level of protection if a correct sitting position is assumed. Volkswagen recommends using a Volkswagen dealership for this purpose.

Volkswagen recommends the following seating position for your own safety and to reduce the level of injury in the event of a sudden braking manoeuvre or an accident:

The following applies to all vehicle occupants:

- Adjust the head restraint so that its upper edge is at the same height as the top of the head, but not lower than eye level. Position the back of your head as close to the head restraint as possible → *Fig. 39* and → *Fig. 40*.
- When adjusting for short people, push the head restraint all the way down, even if the head is then underneath the top edge of the head restraint.
- For taller people, push the head restraint up as far as it will go.
- Move the backrest into an upright position so that your back rests fully against it.
- Keep both feet in the footwell while the vehicle is in motion.
- Adjust and fasten seat belts properly → *Seat belts* .

Additional points for the driver:

- Adjust the steering wheel so that the distance → *Fig. 39* ④ between the steering wheel and your breastbone is at least 25 cm and the circumference of the steering wheel can be held at the sides with the arms slightly bent.
- The steering wheel must always point towards the breastbone and not towards the face.
- Adjust the driver seat so that you are able to press the pedals with your knees still slightly bent.
- Adjust the height so that you can reach the highest point of the steering wheel.
- Always leave both feet in the footwell, to help ensure you maintain control of the vehicle at all times.

Additional points for the front passenger:

- Push the front passenger seat as far back as possible so that the airbag can provide maximum protection if it is triggered.

Mechanical controls on the front seats

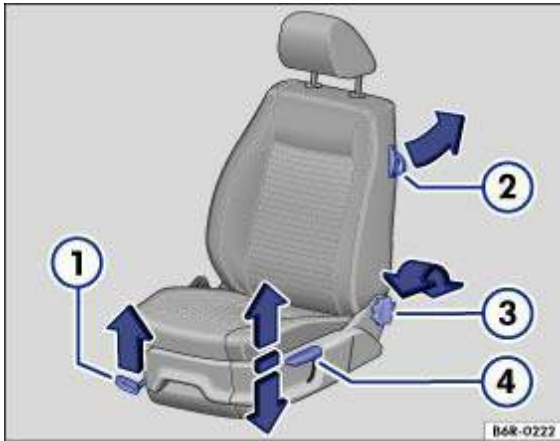


Fig. 41 Front left seat controls with convenient entry function

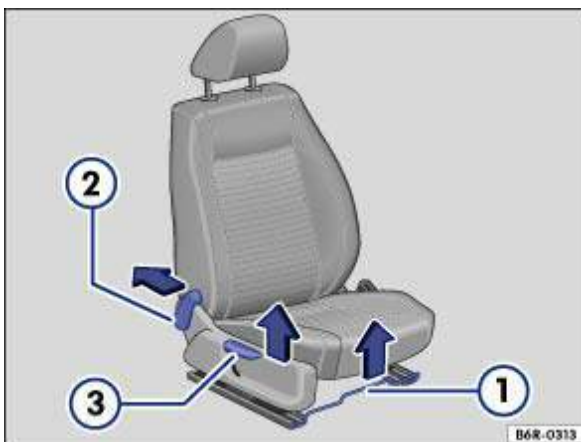




Fig. 42 Front right seat controls without convenient entry function

 First read and observe the introductory information and safety warnings →  [Introduction](#)

Front left seat controls with convenient entry function

The layout of the controls on the front right-hand seat is a mirror image of the layout of the controls on the front left-hand seat.

→ Fig. 41	Function	Action
①	Pushing the front seat forwards or backwards.	Lift the handle and move the front seat. The front seat must engage after you let go of the lever!
②	Folding the seat backrest forwards or backwards (2-door vehicles only).	<i>Folding forwards:</i> pull lever and fold seat backrest forward. If necessary, push the seat forwards at the same time.
		<i>Folding back:</i> pull lever and fold seat backrest back. The backrest must click into place. If necessary, slide the seat back as far as it will go.
③	Adjusting the backrest.	Turn handwheel.
④	Adjusting the seat height.	Move the lever up or down several times as required.

Front right seat controls without convenient entry function.

The control elements are mirrored for the front left-hand seat.

→ Fig. 42	Function	Action

①	Pushing the front seat forwards or backwards.	Pull the bar upwards and move the front seat. The front seat must engage after you let go of the bar!
②	Adjusting the backrest.	Push the lever back and adjust the backrest. The backrest must engage after you let go of the lever → ⚠!
③	Adjusting the seat height.	Pull the lever upwards and adjust the seat height using your body weight. The seat must engage after you let go of the lever!



WARNING

Injuries could be caused if the backrests are folded forwards and backwards carelessly.

- Never fold the seat backrest forwards or backwards while the vehicle is in motion.
- While folding the seat backrest forwards, always ensure that there are no people, animals or objects in its path.
- When folding forwards and backwards, keep all hands, fingers, feet and other body parts away from the seat hinges and seat release mechanism.
- Floor mats or other objects could get caught in the hinges on the seat backrest. The seat backrest might then not engage securely when it is returned to the upright position.
- Passengers (adults and children) must not use seats if the backrest is folded forwards or is not clicked securely into place.
- When being folded back, the seat backrest must be securely locked in the upright position. If the seat backrest is not locked properly it could move suddenly and cause severe injuries.

Adjusting the head restraints

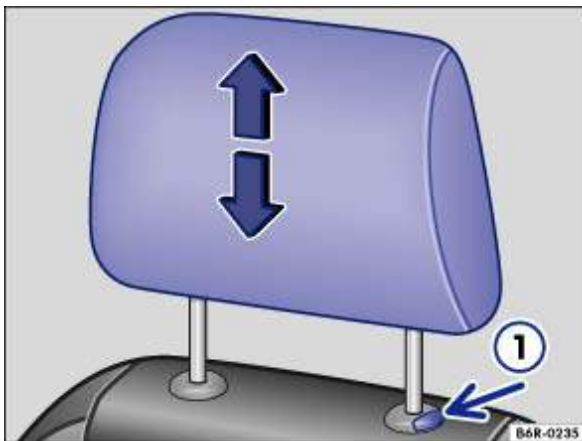


Fig. 43 Adjusting front head restraint

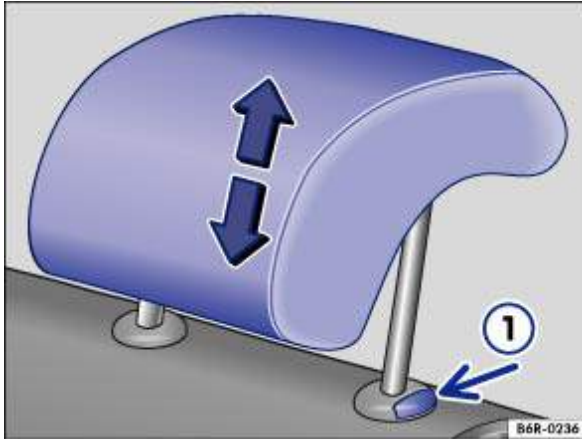





Fig. 44 Adjusting rear head restraint



First read and observe the introductory information and safety warnings →  [Introduction](#)

Every seat is fitted with a head restraint. The centre rear head restraint is designed solely for use with the centre rear seat. This head restraint should therefore not be installed in any of the other positions.

Adjusting the height

- Push the head restraint up in the direction of the arrow or push it down with the button pressed → [Fig. 43](#)  or → [Fig. 44](#)  → .
- The head restraint must click securely into position.

Correct head restraint setting

Adjust the head restraint so that its upper edge is at the same height as the top of the head, but not lower than eye level. Position the back of your head as close to the head restraint as possible.

Head restraint setting for shorter people

Push the head restraint all the way down, even if the head is then underneath the top edge of the head restraint. There may be a small gap between the head restraint and backrest in the lowest position.

Head restraint setting for taller people

Push the head restraint up as far as it will go.



WARNING

Driving without head restraints or with incorrectly adjusted head restraints increases the risk of severe or fatal injuries in the event of an accident or sudden driving or braking manoeuvre.

- If a seat is occupied, the head restraint for that seat must be fitted and adjusted correctly.
- Each vehicle occupant must adjust the head restraint to suit their body size, to help reduce the risk of neck injuries in an accident. As far as possible, the upper edge of the head restraint must be level with the top of the head, but not lower than eye level. Position the back of your head as close to the head restraint as possible.
- Never adjust the head restraint when the vehicle is in motion.


Removing and fitting head restraints



First read and observe the introductory information and safety warnings →  [Introduction](#)

Every seat is fitted with a head restraint. The centre rear head restraint is designed solely for use with the centre rear seat. This head restraint should therefore not be installed in any of the other positions.

Removing the head restraint

- If necessary, unlock the backrests and fold them forwards → [Luggage compartment](#) .
- Push the head restraint all the way up →  .
- Pull the head restraint out while pressing the ① → [Fig. 43](#) or → [Fig. 44](#) button.
- If necessary, push back the backrest and allow to engage securely.

Fitting the head restraint

- If necessary, unlock the backrests and fold them forwards → [Luggage compartment](#) .
- Position the head restraint correctly over the head restraint guides and then insert into the guides of the corresponding seat backrest.
- Press and hold the ① → [Fig. 43](#) or → [Fig. 44](#) button and push down the head restraint.
- If necessary, push back the backrest and allow to engage securely.
- Adjust the head restraint so that a correct sitting position can be assumed → [Adjusting the head restraints](#) .



WARNING

Driving without head restraints or with incorrectly adjusted head restraints increases the risk of severe or fatal injuries in the event of an accident or sudden driving or braking manoeuvre.

- If a seat is occupied, the head restraint for that seat must be fitted and adjusted correctly.
- Head restraints that have been removed should be fitted as soon as possible so that passengers have correct protection.



NOTICE

When removing or fitting head restraints, make sure that they do not hit the roof or other parts of the vehicle. This could damage the headliner or other parts of the vehicle.

Adjusting the steering wheel position

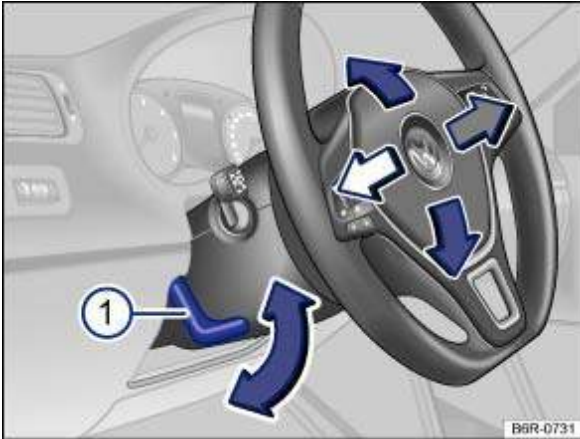



Fig. 45 Adjusting the steering wheel position mechanically

 **First read and observe the introductory information and safety warnings** →  *Introduction*

Adjust the steering wheel position before setting off and only when the vehicle is stationary.

- Push down the lever → *Fig. 45* ① .
- Adjust the steering wheel so that you can hold it on the outside of the ring (at the 9 o'clock and 3 o'clock positions) with both hands and slightly bent arms.
- Push the lever up firmly until it lines up with the steering column →  .



WARNING

Incorrect use of the steering column position adjustment and incorrect adjustment of the steering wheel can cause serious or fatal injuries.

- After adjusting the steering column, always move lever → *Fig. 45* ① up so that it engages securely. This prevents the steering column from moving spontaneously while the vehicle is in motion.
- Never adjust the steering wheel when the vehicle is in motion. If you determine that a readjustment is necessary, stop the vehicle safely and adjust the steering wheel to the correct position.
- The steering wheel must always point towards the chest and not towards the face. This ensures that the driver front airbag provides maximum protection in the event of an accident.
- While driving, always keep both hands on the outside of the steering wheel, at the 9 o'clock and 3 o'clock positions. This reduces the risk of injury if the driver front airbag is triggered.
- Never hold the steering wheel at the 12 o'clock position, or in any other manner, e.g. on the hub of the steering wheel. If the driver airbag is triggered, you could receive severe injuries to the arms, hands and head.

Centre armrest



Fig. 46 Front centre armrest



First read and observe the introductory information and safety warnings →  [Introduction](#)

To *lift*, pull the centre armrest up gradually in the direction of the arrow → [Fig. 46](#).

To *lower*, pull the centre armrest all the way up. Then lower the centre armrest.



WARNING

The centre armrest can obstruct the driver's arm movements. This can cause accidents and severe injuries.

- Always keep the stowage compartments in the centre armrest closed while the vehicle is in motion.
- Never transport an adult or child on the centre armrest. An incorrect seating position can cause serious injury.
- Never place hot drinks or fluids in the drink holders. These can be spilt during a braking or driving manoeuvre.

Seat functions



Introduction

This chapter contains information on the following subjects:

→ [Seat heating](#)

Additional information and warnings:

- Adjusting the seat position → [Adjusting the seat position](#)
- Seat belts → [Seat belts](#)
- Airbag system → [Airbag system](#)
- Child seats → [Child seats](#)
- Exterior mirrors → [Mirrors](#)
- Luggage compartment → [Luggage compartment](#)



WARNING

Incorrect use of the seat functions can cause serious injuries.

- Always assume a correct sitting position before you drive and maintain this position throughout the trip. This also applies to all passengers.
- Keep hands, fingers, feet and other body parts away from the moving parts of the seats.

Seat heating

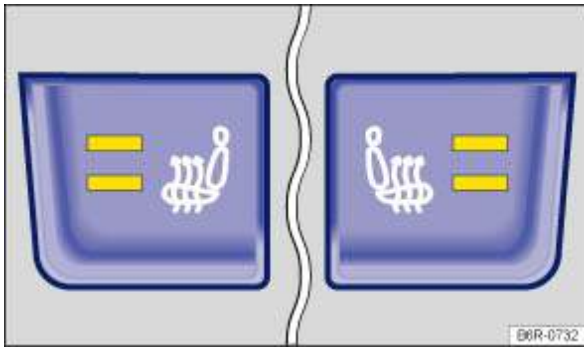


Fig. 47 In upper part of centre console: buttons for the front seat heating






First read and observe the introductory information and safety warnings →  *Introduction*

The seat cushions on the front seats can be heated electrically when the ignition is switched on. In some versions, the backrests may also be heated.

Do not switch on the seat heating if one of the following conditions applies:

- The seat is not in use.
- The seat is fitted with a protective cover.
- A child seat is installed on the seat.
- The seat cushion is damp or wet.
- The interior or exterior temperature is above 25°C (77°F).

Function	Action
Switching on	Press the  button. The seat heating is switched on at maximum level and all indicator lamps in the button are lit up → Fig. 47.
Adjusting the heating output	Press the  button repeatedly until the desired heating level is set.
Switching off	Press the  button until the indicator lamps in the button go out. OR: switch off the ignition.

If the second temperature level has been switched on for more than 15 minutes, it will automatically switch to the first temperature level. Only one indicator lamp will be lit up.



WARNING

Anyone experiencing reduced sensitivity to pain or temperature due to medication, paralysis or chronic illness (e.g. diabetes) could sustain burns on the back, buttocks and legs when using the seat heating. These burns may take a long time to heal or may never heal fully. Please consult a doctor to determine your own level of health.

- Anyone experiencing reduced sensitivity to pain or temperature should never use the seat heating.

**WARNING**

Wet upholstery can cause a fault in the seat heating and increase the risk of burns.

- Make sure that the seat cushion is dry before using the seat heating.
- Do not sit on the seat when wearing damp or wet clothing.
- Do not set any damp or wet objects or items of clothing on the seat.
- Do not spill any liquids on the seat.

**NOTICE**

- To avoid damaging the heating elements, do not kneel on the seat or apply sharp pressure at a single point on the seat cushion and backrest.
- Liquids, sharp objects and insulating materials such as a protective cover or child seat on the seat could damage the seat heating.
- If the system starts to emit a smell, switch the seat heating off immediately and have it checked by a qualified workshop.




The seat heating should be switched off as soon as it is no longer needed. Fuel is otherwise wasted.

Seat belts

Introduction

This chapter contains information on the following subjects:

- *Warning lamp*
- *Frontal collisions and the laws of physics*
- *What happens to vehicle occupants who have not fastened their seat belts*
- *Seat belt protection*
- *Using seat belts*
- *Fastening and unfastening seat belts*
- *Seat belt routing*
- *Belt height adjuster*
- *Automatic belt retractor, belt tensioner, belt tension limiter*
- *Service and disposal of belt tensioners*

Check the condition of all seat belts regularly. If the belt webbing, belt connections, belt retractor or seat belt buckle become damaged, the seat belt in question should be replaced immediately by a qualified workshop → . The qualified workshop must use correct spare parts that are compatible with the vehicle, equipment level and model year. Volkswagen recommends using a Volkswagen dealership for this purpose.

Additional information and warnings:

- Adjusting the seat position → *Adjusting the seat position*
- Airbag system → *Airbag system*
- Child seats → *Child seats*
- Stowage → *Stowage areas*
- Cleaning and caring for the interior → *Cleaning and caring for the interior*
- Accessories, modifications, repairs and renewal of parts → *Accessories, modifications, repairs and renewal of parts*

**WARNING**

Incorrectly fastened or unfastened seat belts increase the risk of severe or fatal injuries. Seat belts will only offer the optimum level of protection when they are fastened and used properly.

- Seat belts are the most effective means of reducing the risk of serious and fatal injuries in the event of an accident. Seat belts must always be fastened properly when the vehicle is in motion to protect the driver and all vehicle occupants.
- Before every trip, each vehicle occupant must adopt the correct sitting position, correctly fasten the seat belt belonging to their seat and keep it fastened properly throughout the trip. This applies to all vehicle occupants and also in urban traffic.
- While the vehicle is in motion, secure all children travelling in the vehicle in a restraint system suitable for their weight and height. They must also wear correctly fastened seat belts → *Child seats* .
- Only start driving when all passengers have correctly fastened their seat belts.
- Only ever insert the latch plate into the buckle of the associated seat, and always ensure that it engages properly. Using a buckle that does not belong to the seat that you are occupying reduces the level of protection and can lead to severe injuries.
- Avoid allowing foreign bodies or liquids to enter the slot for the seat belt buckle. This could prevent the belt buckle and seat belt from working properly.
- Never unfasten the seat belt while the vehicle is in motion.
- Never allow more than one person to share the same seat belt.
- Never travel when children or babies are being carried on somebody's lap and fastened with the same belt.
- Never travel wearing loose, bulky clothing (such as an overcoat over a jacket). This could prevent the seat belts from fitting and functioning properly.

**WARNING**

Damaged seat belts are very dangerous and can cause severe or fatal injuries.

- Never damage the belt by trapping it in the door or in the seat mechanism.
- If the belt webbing or any other part of the seat belt becomes damaged, the seat belt may tear during an accident or sudden braking manoeuvre.
- Have damaged seat belts immediately replaced by new seat belts that have been approved by Volkswagen for the vehicle. Seat belts subjected to stress and stretched during an accident must be replaced by a qualified workshop. Renewal may be necessary even if there is no apparent damage. The belt anchorage should also be checked.
- Never try to repair, modify or remove the seat belts yourself. All repairs to the seat belts, belt retractors and buckles must be carried out by a qualified workshop.

Warning lamp



Fig. 48 Warning lamp in the instrument cluster

First read and observe the introductory information and safety warnings → Introduction

Lights up or flashes	Possible cause	Action
	The driver seat belt and, if the front passenger seat is occupied, the front passenger seat belt are not fastened.	Fasten seat belts.
	OR: there are objects on the front passenger seat.	Remove objects from the front passenger seat and stow them safely.

Several warning and indicator lamps will light up briefly as a functional check when the ignition is switched on. They will go out after a few seconds.

A signal tone will be given for a few seconds if the seat belts are not fastened as the car pulls off and reaches a speed of more than approximately 25 km/h (15 mph), or if the seat belts are unfastened while the vehicle is in motion. The warning lamp → Fig. 48 will also flash.

When the ignition is switched on, the warning lamp will not go out until the driver and front passenger fasten their seat belts.

WARNING

Incorrectly fastened or unfastened seat belts increase the risk of severe or fatal injuries. Seat belts will only offer the optimum level of protection when they are fastened and used properly.

Frontal collisions and the laws of physics



Fig. 49 Unbelted occupants in a vehicle heading for a brick wall

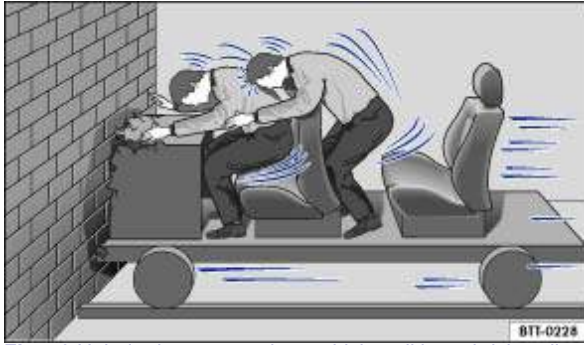


Fig. 50 Unbelted occupants in a vehicle striking a brick wall



First read and observe the introductory information and safety warnings →  *Introduction*

The physical principles involved in a frontal collision are relatively simple. As soon as the vehicle is in motion → *Fig. 49*, both the moving vehicle and its passengers gain kinetic energy.

The higher the vehicle speed and the heavier the weight of the vehicle, the greater the amount of energy that will have to be released in the event of an accident.

However, the most significant factor is the speed of the vehicle. If the speed doubles from approximately 25 km/h (15 mph) to approximately 50 km/h (31 mph), for example, the kinetic energy increases by a factor of four.

The amount of kinetic energy depends on the speed of the vehicle and the weight of the vehicle and passengers. The higher the speed and the heavier the weight, the greater the amount of energy that will be released in the event of an accident.

Passengers not wearing seat belts are not connected to the vehicle. In the event of a frontal collision they will continue to move forwards at the same speed at which the vehicle was travelling before impact, until something stops them. Because the passengers in our example are not restrained by seat belts, the entire amount of kinetic energy will only be released at the point of impact against the wall → *Fig. 50*.

Even at speeds of approximately 30 km/h (19 mph) to approximately 50 km/h (31 mph), the forces acting on bodies in a collision can easily exceed one tonne (1,000 kg). These forces are even greater at higher speeds.

This example applies not only to frontal collisions, but to all accidents and collisions.

What happens to vehicle occupants who have not fastened their seat belts



Fig. 51 An unbelted driver is thrown forwards



Fig. 52 The unbelted rear passenger is thrown forwards, hitting the belted driver



First read and observe the introductory information and safety warnings →  *Introduction*

Many people believe that they can brace their weight with their hands in a minor collision. This is not true.

Even at low speeds, the forces acting on the body in a collision are so great that occupants cannot brace themselves with their arms and hands. In a frontal collision, unbelted vehicle occupants are thrown forward and will make unchecked contact with parts of the vehicle interior, e.g. the steering wheel, dash panel, or windscreen → *Fig. 51*.

The airbag system is not a substitute for the seat belts. When triggered, the airbags only provide additional protection. Airbags are not triggered in all kinds of accidents. Even if the vehicle is equipped with an airbag system, all vehicle occupants, including the driver, must fasten their seat belt and wear it correctly while the vehicle is in motion. This reduces the risk of severe or fatal injuries in the event of an accident – regardless of whether an airbag is fitted for the seat.

Each airbag can only be triggered once. To achieve best possible protection, seat belts must always be worn properly. This also ensures that protection is provided in accidents in which the airbag is not triggered. Any vehicle occupants not wearing a seat belt can be thrown out of the vehicle and sustain more severe or even fatal injuries as a result.

It is also important for the rear seat occupants to wear seat belts properly, as they could otherwise be thrown forwards violently in an accident. Rear passengers who are not wearing seat belts endanger not only themselves and the driver, but also other people in the vehicle → *Fig. 52*.

Seat belt protection



Fig. 53 Driver restrained by a properly positioned seat belt during a sudden braking manoeuvre



First read and observe the introductory information and safety warnings →  *Introduction*

Correctly fastened seat belts can make a major difference. When fastened properly, seat belts hold the vehicle occupants in the correct sitting positions and considerably reduce the kinetic energy in the event of an accident. Seat belts also help to prevent uncontrolled movements which could lead to severe injuries. In addition, wearing seat belts properly reduces the risk of being thrown from the vehicle → *Fig. 53*.

Passengers wearing seat belts correctly benefit greatly from the ability of the belts to reduce the kinetic energy. The front crumple zones and other passive safety features (such as the airbag system) are also designed to reduce kinetic energy. The amount of energy generated will thus decrease, thereby reducing the risk of injury.

The examples describe frontal collisions. Of course, properly worn seat belts substantially reduce the risk of injury in all other types of accidents. This is why seat belts must be fastened before every trip – even if you are only planning to drive a very short distance. Make sure that all passengers are also wearing their seat belts properly.

Accident statistics have shown properly worn seat belts to be an effective means of substantially reducing the risk of injury and improving the chances of survival in a serious accident. Furthermore, properly worn seat belts improve the protection provided by airbags in the event of an accident. This is why wearing a seat belt is a legal requirement in most countries.

Although the vehicle is equipped with airbags, the seat belts must be fastened and worn. For example, the front airbags will only be triggered in certain types of frontal collision. The front airbags will not be triggered during minor frontal collisions, minor side collisions, rear collisions, rolls or accidents in which the airbag trigger threshold in the control unit is not exceeded.

Therefore, always wear your seat belt and make sure that your passengers have fastened their seat belts properly before you drive off.







Using seat belts



First read and observe the introductory information and safety warnings →  [Introduction](#)

Checklist

Using seat belts →  :

-  Check the condition of all seat belts regularly.
-  Keep the seat belts clean.
-  Never let any foreign bodies and liquids get on to the seat belt, the latch plate or into the slot for the seat belt buckle.
-  Do not trap or damage the seat belt and latch plate, for example when closing the door.
-  Never remove, modify or repair the seat belt or any part of the belt fixture system.
-  Always fasten the seat belt correctly before every journey and keep it fastened while the vehicle is in motion.

Twisted seat belt

If it is difficult to remove the seat belt from the belt guide, the seat belt may have become twisted if it was returned too quickly into the side trim:

- Take hold of the latch plate then slowly and carefully pull out the seat belt.
- Untwist the seat belt and guide it back slowly by hand.

Fasten the seat belt even if you are unable to undo the twist. However, the twist should not be in part of the seat belt that comes into direct contact with the body. The twist should be corrected immediately by a qualified workshop.

⚠ WARNING

Using seat belts incorrectly increases the risk of severe or fatal injuries.

- Regularly check to see if the seat belt and its related parts are in perfect condition.
- Always keep the seat belt clean.
- Do not allow the belt webbing to become jammed, damaged or to rub on any sharp edges.
- Always keep the latch plate and slot in the buckle free from foreign bodies and liquids.

Fastening and unfastening seat belts

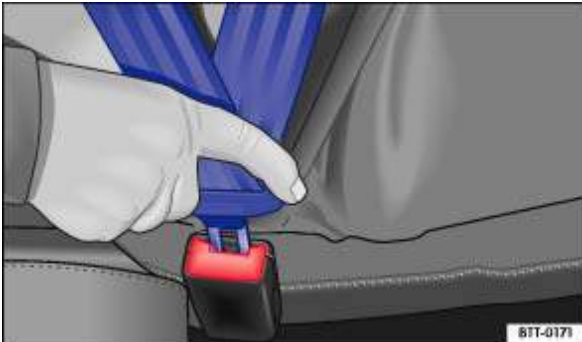


Fig. 54 Inserting the seat belt latch plate into the buckle



Fig. 55 Removing the latch plate from the buckle



First read and observe the introductory information and safety warnings → ⚠ *Introduction*

If worn properly, seat belts hold the vehicle occupants in the correct sitting position during an accident or braking manoeuvre, providing maximum protection → ⚠ .

Fastening the seat belts

Fasten seat belts before every trip.

- Always adjust the front seat and head restraint correctly → *Adjusting the seat position* .
- Engage the rear seat backrests in an upright position → ⚠ .
- Take hold of the latch plate and pull it evenly across your chest and pelvis. Do **not** twist the belt in the process → ⚠ .
- Insert the latch plate securely into the buckle belonging to the occupied seat → *Fig. 54* .
- Pull on the seat belt to ensure that the latch plate is securely locked in the buckle.

Unfastening the seat belts

Unfasten seat belts only when the vehicle is stationary → ⚠.

- Press the red button in the buckle → Fig. 55. The latch plate is released and springs out.
- Guide the belt back by hand so that it rolls up easily, without twisting the seat belt and without damaging the trim.

⚠ WARNING

Incorrect seat belt routing can cause severe or fatal injuries in the event of an accident.

- The seat belts only offer best protection when the backrests are in an upright position and the seat belts have been fastened properly according to the occupant's height.
- Unfastening seat belts while the vehicle is in motion can lead to severe or fatal injuries in the event of an accident or sudden braking manoeuvre.

Seat belt routing

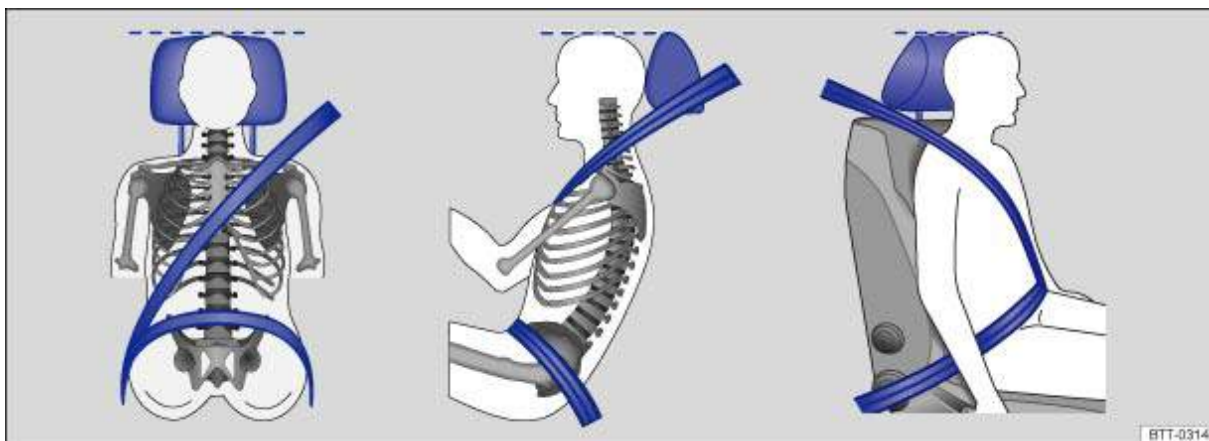


Fig. 56 Correct seat belt routing and head restraint adjustment



Fig. 57 Correct seat belt routing during pregnancy



First read and observe the introductory information and safety warnings → ⚠ Introduction

Seat belts only provide an optimum level of protection during an accident when they are routed correctly. Correct seat belt routing reduces the

risk of severe or fatal injuries. Correct seat belt routing also holds the vehicle occupants in position so that an inflating airbag can offer the maximum level of protection. Therefore you must always fasten your seat belt and ensure that the seat belt routing is correct.

Assuming an incorrect sitting position can cause severe or fatal injuries → [Adjusting the seat position](#) .

Correct seat belt routing

- The shoulder part of the seat belt must always lie on the centre of the shoulder, never across the neck, over or under the arm or behind the back.
- The lap part of the seat belt must always lie across the pelvis, never across the stomach.
- The seat belt must always lie flat and snugly on the body. Tighten the belt if necessary.

For **pregnant women** the seat belt must be positioned evenly over the chest and as low as possible over the pelvis. It must lie flat so that no pressure is exerted on the lower body – this applies in every stage of pregnancy → [Fig. 57](#).

Correct seat belt routing according to height

The following equipment can be used to adjust the seat belt routing:

- Belt height adjuster for the front seats → [Belt height adjuster](#) .
- Height-adjustable front seats → [Adjusting the seat position](#) .



WARNING

Incorrect seat belt routing can cause severe injuries in the event of an accident or a sudden braking or driving manoeuvre.

- The seat belts only offer best protection when the backrests are in an upright position and the seat belts have been fastened properly.
- The seat belt itself or a loose seat belt can cause serious injuries if the seat belt shifts from harder body parts in the direction of softer body parts (e.g. stomach).
- The shoulder part of the seat belt must lie on the centre of the shoulder and never under the arm or across the neck.
- The seat belt must lie flat and snugly on the chest.
- The lap part of the seat belt must lie across the pelvis and never across the stomach. The seat belt must lie flat and snugly on the pelvis. Tighten the belt if necessary.
- For pregnant women, the lap part of the seat belt must be as low as possible over the pelvis and lie flat around the bulge of the belly.
- Do not twist the belt webbing while the seat belt is being worn.
- Never hold the seat belt away from the body by hand.
- The belt webbing should not lie over hard or fragile objects, such as glasses, pens or keys.
- Never use seat belt clips, retaining rings or similar items to alter the seat belt routing.



If a person's physical build prevents them from routing the seat belt properly, contact a qualified workshop to find out about any special modifications so that the seat belts and airbags can provide the optimum level of protection. Volkswagen recommends using a Volkswagen dealership for this purpose.

Belt height adjuster



Fig. 58 Next to the front seats: belt height adjuster



First read and observe the introductory information and safety warnings →  [Introduction](#)

The seat belt height adjusters for the front seats can be used to adjust the position of the seat belt on the shoulder so that it can be fastened properly:

- Push the shoulder belt guide together in the direction of the arrows and hold → [Fig. 58](#).
- Push the shoulder belt guide up or down so that the seat belt lies over the middle of the shoulder → [Seat belt routing](#) .
- Let go of the shoulder belt guide.
- Pull sharply on the seat belt to check whether the shoulder belt guide is engaged securely.



WARNING

Never adjust the seat belt height when the vehicle is in motion.

Automatic belt retractor, belt tensioner, belt tension limiter



First read and observe the introductory information and safety warnings →  [Introduction](#)

The seat belts in the vehicle are part of the vehicle safety concept → [Airbag system](#) and include the following important functions:

Automatic belt retractor

The seat belts on the driver seat and front passenger seat, as well as those on the outer rear seats (and on the middle rear seat, depending on the level of vehicle equipment), are fitted with an automatic belt retractor at the shoulder part of the seat belt. Full freedom of movement is made possible when the shoulder belt is pulled slowly or when the vehicle is travelling at normal speeds. However, if the belt is pulled out quickly or during sudden braking, during travel in mountains or bends and during acceleration, the automatic belt retractor is locked.

Belt tensioners

The seat belts for the front seat occupants are equipped with belt tensioners.

The belt tensioners are activated by sensors during severe frontal, side and rear collisions. They tighten the seat belts against the direction in which they are pulled. Any slack in the seat belt is retracted, which can reduce the passenger's movement forwards or in the direction of the impact. The belt tensioner works together with the airbag system. If the side airbags or the combined curtain airbags are not activated, the belt tensioner will not be activated in the event that the vehicle rolls over.

A fine dust may be produced when the airbags are triggered. This is quite normal and does not mean that there is a fire in the vehicle.

Belt tension limiter

The belt tension limiter reduces the pressure exerted by the seat belt on the body during an accident.



All safety requirements must be observed when the vehicle or components of the system are scrapped. Qualified workshops are familiar with these requirements → *Service and disposal of belt tensioners* .

Service and disposal of belt tensioners



First read and observe the introductory information and safety warnings → *Introduction*

Seat belts may become damaged during any work on the belt tensioners or while removing or refitting any vehicle parts in conjunction with any other repair work. This damage will not always be noticeable. The consequence may be that the belt tensioners could function incorrectly, or not function at all, in the event of an accident.

Regulations must be observed to ensure that the effectiveness of the belt tensioner is not reduced and that removed parts do not cause any injuries or environmental pollution. Qualified workshops are familiar with these requirements.



WARNING

The risk of severe or fatal injuries may be increased if the seat belts, automatic belt retractors and belt tensioners are not used correctly, or if they are repaired by a non-professional. As a result, the belt tensioners may not be triggered when they should, or they may be triggered unexpectedly.

- Any repairs, adjustments or removal and refitting of parts in the belt tensioners or seat belts should always be carried out by a qualified workshop and never by yourself → *Accessories, modifications, repairs and renewal of parts* .
- Belt tensioners and automatic belt retractors cannot be repaired. They must be replaced.



The airbag modules and belt tensioners may contain perchlorate. Please comply with legislation regarding disposal.

Airbag system



Introduction

This chapter contains information on the following subjects:

- *Types of front passenger front airbag system*
- *Indicator lamps*
- *Description and function of the airbags*
- *Front airbags*
- *Switching the front passenger front airbag on and off manually using the key-operated switch*
- *Side airbags*
- *Combined curtain and side airbags*
- *Curtain airbags*

The vehicle is equipped with a front airbag for the driver and front passenger. The front airbags can provide front seat occupants with additional chest and head protection if the seat, seat belts, head restraints and, in the case of the driver, steering wheel are adjusted and used correctly. Airbags are meant only for additional protection. The airbags are not a substitute for seat belts. Seat belts must always be worn, even when the front seats are equipped with front airbags.

Additional information and warnings:

- Driving tips → *Driving tips*

- Central locking system → [Central locking system](#)
- Correct sitting position → [Adjusting the seat position](#)
- Seat belts → [Seat belts](#)
- Child seats → [Child seats](#)
- Cleaning and caring for the interior → [Cleaning and caring for the interior](#)
- Accessories, modifications, repairs and renewal of parts → [Accessories, modifications, repairs and renewal of parts](#)
- Consumer information → [Consumer information](#)



WARNING

Never rely solely on the airbag system for your protection.

- Even if an airbag is triggered, it only offers auxiliary protection.
- The airbag system offers the best level of protection, and reduces the risk of injury, when seat belts are properly worn → [Seat belts](#) .
- Before every trip, each vehicle occupant must adopt the correct sitting position, correctly fasten the seat belt belonging to their seat and keep it fastened properly throughout the trip. This applies to all vehicle occupants and also in urban traffic.



WARNING

The risk of injury increases if there are any objects between the vehicle occupants and the deployment area of the airbag when it is triggered. This will alter the deployment zone of the airbag, or the objects will be flung against the body.

- Never hold any objects in your hand or on your lap while the vehicle is in motion.
- Never transport any objects on the front passenger seat. The objects could enter the deployment zone of the airbag during sudden braking or driving manoeuvres and then be flung dangerously through the vehicle interior if the airbag is activated.
- Vehicle occupants sitting on the front seats and rear outer seats must never carry any people, pets or objects in the deployment zone between themselves and the airbags. Make sure that children and passengers also keep to this rule.



WARNING

The airbag system can only be triggered once. The system will have to be replaced if the airbags have been triggered.

- Airbags that have been triggered, and any affected system parts, must immediately be replaced with new parts that are approved by Volkswagen for the vehicle.
- Repairs and modifications to your vehicle should only be carried out by a qualified workshop. Qualified workshops have the necessary tools, diagnostic equipment, repair information and qualified personnel.
- Never use recycled airbag components or components that have been taken from end-of-life vehicles in your vehicle.
- Never alter any components of the airbag system.

⚠ WARNING

Fine dust or steam may be released when the airbags trigger. This is normal and does not mean that there is a fire in the vehicle.



- The fine dust can cause irritation to the skin and eye membranes and cause breathing difficulties, particularly for people suffering from asthma or people who have (had) other respiratory problems. To help reduce breathing difficulties, get out of the vehicle or open the windows or doors for more fresh air.
- If you come into contact with the dust, you should wash your hands and face with a mild soap and water before eating.
- Do not let the dust get into your eyes or into open wounds.
- If dust has entered your eyes, rinse them with water.

⚠ WARNING




Cleaning agents that contain solvents cause the surface of the airbag modules to become porous. In an accident that triggers the airbag, loose plastic parts can cause serious injury.

- Never clean the dash panel or the airbag covers with cleansers that contain solvents.

Types of front passenger front airbag system

 First read and observe the introductory information and safety warnings →  *Introduction*

Volkswagen offers two different front airbag systems for front passengers:

A	B
<p>Features of the front passenger front airbag that can only be switched off by a qualified workshop.</p>	<p>Features of the front passenger front airbag that can be switched off manually using the key-operated switch → <i>Switching the front passenger front airbag on and off manually using the key-operated switch</i> .</p>
<ul style="list-style-type: none"> – Indicator lamp  in the instrument cluster. – Front passenger front airbag in the dash panel. 	<ul style="list-style-type: none"> – Indicator lamp  in the instrument cluster. – Indicator lamp in top area of the centre console  .PASSENGER AIR BAG. OFF – Key-operated switch in the stowage compartment in the dash panel on the front passenger side. – Front passenger front airbag in the dash panel.
<p>Name: airbag system.</p>	<p>Name: airbag system with front passenger front airbag deactivation.</p>

Indicator lamps



Fig. 59 In the upper section of the centre console: indicator lamp for disabled front passenger front airbag

First read and observe the introductory information and safety warnings → [Introduction](#)

Lit up	Location	Possible cause	Action
	Instrument cluster	Fault in airbag and belt tensioner system.	Go to a qualified workshop to have the system checked immediately.
	Upper section of the centre console	Fault in the airbag system.	Go to a qualified workshop to have the system checked immediately.
		Front passenger front airbag switched off.	Check whether the airbag should stay switched off.

Several warning and indicator lamps will light up briefly as a functional check when the ignition is switched on. They will go out after a few seconds.

If the indicator lamp PASSENGER AIR BAG in the upper part centre console is **not continuously** lit or if it lights up together with the indicator lamp in the instrument cluster when the front passenger front airbag is switched off, there may be a fault in the airbag system →

WARNING

If there is a fault in the airbag system, the airbag may not trigger correctly, may not trigger at all or may trigger unexpectedly. This can cause severe or fatal injuries.

- The airbag system should be checked by a qualified workshop as soon as possible.
- Never fit a child seat to the front passenger seat or remove a child seat that is already fitted. The front passenger front airbag may trigger during an accident in spite of the fault.

NOTICE

To avoid damage to your vehicle, always observe the indicator lamps and associated warning texts.

Description and function of the airbags

First read and observe the introductory information and safety warnings → [Introduction](#)

The airbags can protect vehicle occupants during frontal and side collisions by reducing their movement in the direction of the collision.

When an airbag is triggered, it is inflated by a gas generator. This causes the airbag covers to break, and the airbags inflate forcefully to cover


their deployment zones within milliseconds. Once a vehicle occupant wearing a seat belt starts to sink into the inflated airbag, the gas inside the airbag starts to escape to cushion the occupant and slow down their movement. This can reduce the risk of severe and fatal injuries. A triggered airbag will not always prevent other injuries from occurring, such as swelling, bruising, burning and grazing.

Airbags provide no protection for the arms or lower body.

The most important factors for triggering the airbag are the type of accident, the angle of impact, the vehicle speed and the type of object with which the vehicle collides. Therefore, visible damage to the vehicle does not always mean that the airbag should have been triggered.




Whether or not the airbag triggers is determined by the vehicle deceleration rate caused by the collision and registered by the electronic control unit. If this rate is below the reference value programmed into the control unit, the airbags will not be triggered, even though the vehicle may be badly damaged as a result of the collision. Vehicle damage, repair costs or even the lack of vehicle damage in an accident do not necessarily give an indication of whether an airbag should inflate or not. It is not possible to define a range of vehicle speeds and reference values, since the circumstances will vary considerably between one collision and another. It is therefore impossible to cover every possible kind and angle of impact that would trigger the airbags. Important factors in the triggering of the airbag include the nature (hard or soft) of the object that the vehicle hits, the angle of impact, and the vehicle speed.

Airbags only serve as a supplement to the three-point seat belt in some accident situations when the vehicle braking is sufficient to trigger the airbags. Airbags can only be triggered once and only in certain situations. The seat belts are always there to provide protection in situations in which the airbags are not triggered or have already been triggered. For example, if the vehicle collides with a further vehicle following the initial collision, or is hit by another vehicle.

The airbag system is part of the vehicle's overall passive safety concept. The airbag system can only work effectively when the occupants are wearing their seat belts correctly and have assumed a proper sitting position  → [Adjusting the seat position](#) .

Components of the vehicle safety concept

The following vehicle safety equipment makes up the vehicle's safety concept to reduce the risk of severe and fatal injuries. Some of this equipment may not be fitted in your particular vehicle. It may not be available at all in some countries.

- Optimised seat belts for all seats.
- Belt tensioners for driver and front passenger.
- Belt tension limiter for the driver, front passenger and, if applicable, for the rear outer seats.
- Belt height adjuster for the front seats.
- Warning lamp .
- Front airbags for driver and front passenger.
- Combined curtain and side airbags for the driver and front passenger.
- Curtain airbags on the right and left.
- Airbag indicator lamp .
- PASSENGER AIR BAG **OFF**  Indicator lamp in top area of the centre console.
- Control units and sensors.
- Height-adjustable head restraints optimised for rear impact.
- Adjustable steering column.
- If fitted, ISOFIX anchor points for child seats on the rear outer seats.
- If applicable, securing points for the top tether for child seats.

Situations when the front, side, head or combined curtain and side airbags will not be triggered:

- If the ignition is switched off during a collision.

- If the level of deceleration measured by the control unit is too low during a collision at the front of the vehicle.
- During a minor side collision.
- During rear collisions.
- If the vehicle rolls over.
- If the impact speed in a collision is lower than the reference value specified in the control unit.

Front airbags

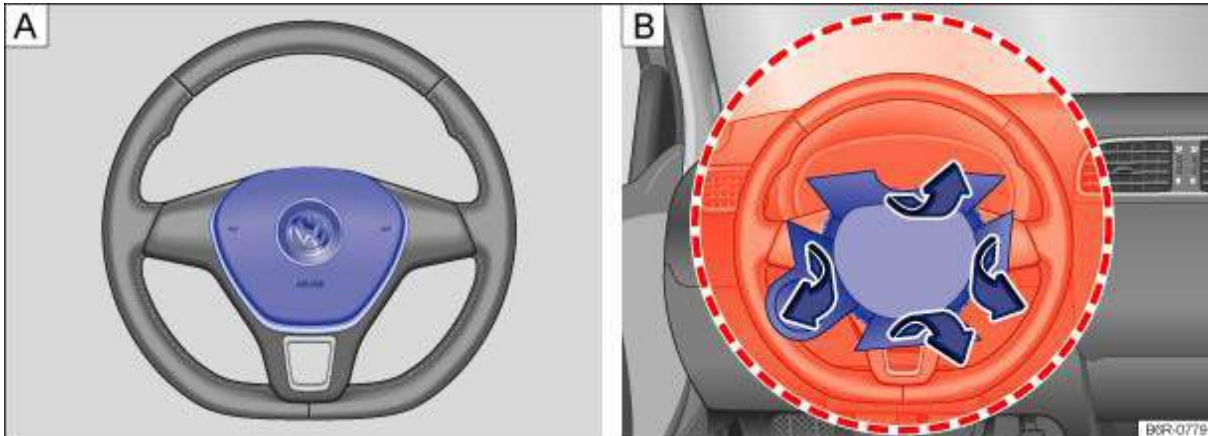


Fig. 60 Location and deployment zone of the driver front airbag

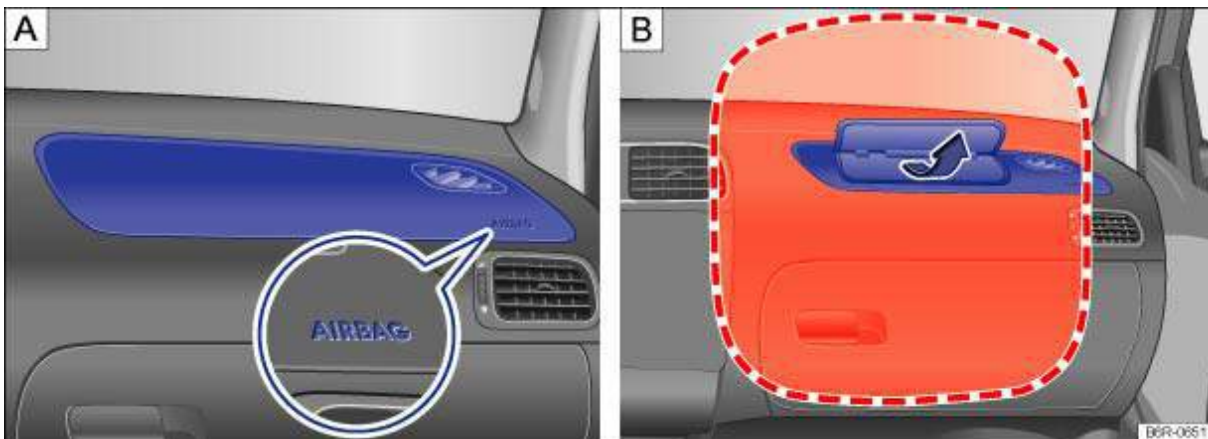



Fig. 61 Location and deployment zone of the front passenger front airbag



First read and observe the introductory information and safety warnings →  *Introduction*

In conjunction with the seat belts, the front airbag system gives the front occupants additional protection for the head and chest in the event of a severe frontal collision. Always keep as far away from the front airbag as possible → *Adjusting the seat position* . This allows the front airbags to inflate fully when triggered, thus providing maximum protection.

The front airbag for the driver is located in the steering wheel → *Fig. 60 A* and the front airbag for the front passenger is located in the dash panel → *Fig. 61 A*. The airbag locations are identified by the text AIRBAG.

The areas inside the red lines → *Fig. 60 B* and → *Fig. 61 B* are covered by the front airbags when triggered (deployment zone). You must never leave or attach any objects in these areas →  . The factory-fitted accessories, such as the base plate for the mobile telephone holder, will not be struck when the driver and front passenger front airbags are triggered.

The airbag covers fold out of the steering wheel → *Fig. 60 B* or dash panel → *Fig. 61 B* when the driver and front passenger airbags deploy.

DANGER

Once triggered, the airbag inflates at high speed.

- Always leave the deployment zones of the front airbags clear.
- Never attach any objects, such as drink or telephone holders, to the covers of the airbags or anywhere in the airbag deployment zone.
- No other people, animals or objects may be carried between the occupants of the front seats and the airbag deployment zone. Make sure that children and passengers also keep to this rule.
- Do not attach any objects, e.g. mobile navigation devices, to the windscreen above the front airbag on the front passenger side.
- Do not cover or stick anything on the steering wheel hub or the soft plastic surface of the airbag unit in the dash panel on the front passenger side, and do not modify them in any way.

WARNING

The front airbags are deployed in front of the steering wheel → *Fig. 60* and dash panel → *Fig. 61*.

- When driving, always hold the steering wheel with both hands on the outside of the ring at the 9 o'clock and 3 o'clock positions.
- Adjust the driver seat so that there is at least 25 cm between your breastbone and the hub of the steering wheel. Contact a qualified workshop if your physical build makes this impracticable.
- Adjust the front passenger seat so that the distance between the passenger and the dash panel is as large as possible.

Switching the front passenger front airbag on and off manually using the key-operated switch



Fig. 62 In the stowage compartment on the front passenger side: key switch for disabling and enabling the front airbag on the front passenger side






First read and observe the introductory information and safety warnings →  *Introduction*




The front passenger front airbag must be switched off when securing a rear-facing child seat to the front passenger seat.

Disabling the front passenger front airbag



- Switch off the ignition.
- Open the stowage compartment on the front passenger side.



- Fold the key bit of the vehicle key all the way out → *Vehicle key set* .
- Insert the open key bit into the key switch in the stowage compartment → *Fig. 62* to the second point of resistance. Around three quarters of the key bit should be inserted in the key switch at this point →  .
- Turn the vehicle key, without applying force, to the **OFF** position.
- Remove the vehicle key from the key switch →  and fold the key bit away.
- Close the stowage compartment on the front passenger side.
- When the ignition is switched on, the indicator lamp PASSENGER AIRBAG **OFF**  will light up steadily in the upper section of the centre console → *Indicator lamps* .

Enabling the front passenger front airbag

- Switch off the ignition.
- Open the stowage compartment on the front passenger side.
- Fold the key bit of the vehicle key all the way out → *Vehicle key set* .
- Insert the open key bit into the key switch in the stowage compartment → *Fig. 62* to the second point of resistance. Around three quarters of the key bit should be inserted in the key switch at this point →  .
- Turn the vehicle key, without applying force, to the **ON** position.
- Remove the vehicle key from the key switch →  and fold the key bit away.
- Close the stowage compartment on the front passenger side.
- Check that the PASSENGER AIRBAG **OFF**  indicator lamp in the upper section of the centre console does *not* light up when the ignition is switched on → *Indicator lamps* .

Ensuring that the front passenger front airbag has been deactivated

The **only** sure sign that the front passenger front airbag has been deactivated is when the PASSENGER AIRBAG **OFF**  indicator lamp is displayed in the upper section of the centre console (**OFF**  lights up yellow steadily) → *Indicator lamps* .

If the indicator lamp PASSENGER AIR BAG **OFF**  in the upper section of the centre console is **not lit up steadily**, or if it lights up at the same time as indicator lamp  in the instrument cluster, do not attach any child restraint system to the front passenger seat for safety reasons. The front passenger front airbag may trigger during an accident.



WARNING

Do not leave the vehicle key in the key switch while driving.

- Strong vibration may cause the vehicle key to turn in the key switch, which could cause the front passenger front airbag to be activated.
- Untimely inflation of the front passenger front airbag could lead to serious or fatal injuries.

⚠ WARNING

The front passenger front airbag should only be switched off in exceptional circumstances.

- To prevent damage to the airbag system, only switch the front passenger front airbag on and off when the ignition is switched off.
- It is the driver's responsibility to ensure that the key-operated switch is set to the correct position.
- Only switch the front passenger front airbag off if, in exceptional circumstances, a child seat has to be attached to the front passenger seat.
- Switch the front passenger front airbag back on again as soon as the child seat on the front passenger seat is no longer being used.

ⓘ NOTICE

If the key bit is not inserted far enough, the key switch could be damaged when the key is turned.

ⓘ NOTICE

Do not leave the vehicle key in the key switch, as this could result in damage to the stowage compartment, key switch or vehicle key when the stowage compartment is closed.

Side airbags

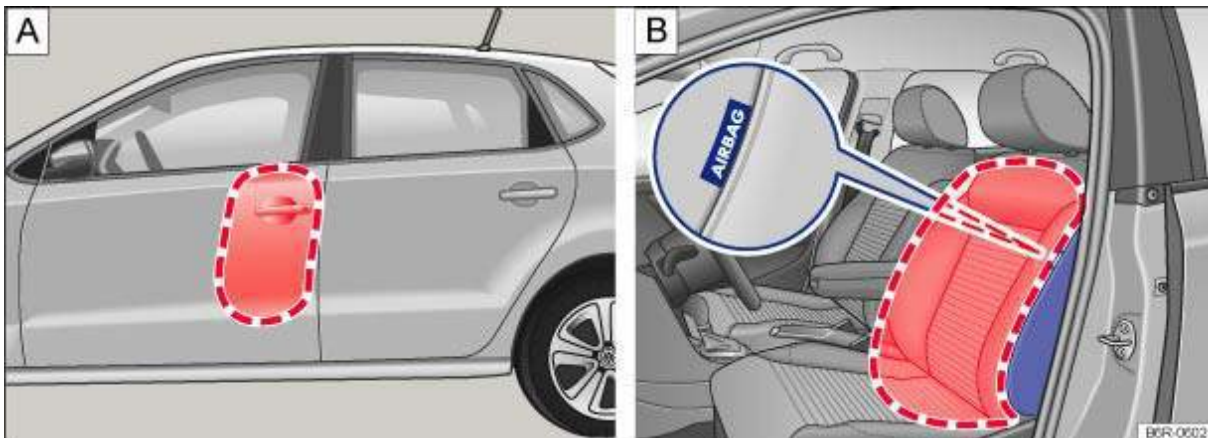





Fig. 63 A: on left-hand side of vehicle: deployment zone of the side airbag. B: on the side of the front seat: location and deployment range of the side airbag

 **First read and observe the introductory information and safety warnings** →  *Introduction*

The side airbags are located in the outer seat backrest cushions of the driver seat and front passenger seat → *Fig. 63 B*. The locations of the airbags are shown by labels with the word AIRBAG.

The areas outlined in red → *Fig. 63* are inside the deployment area of the side airbags. You must never leave or attach any objects in these areas → .

During a side collision, the side airbags will be deployed on the side of the vehicle which is impacted, thus reducing the risk of injury to the areas of the occupants' bodies facing the impact.

WARNING

Once triggered, the airbag inflates at high speed.

- Always leave the deployment zones of the side airbags clear.
- No other people, animals or objects may be carried between the occupants of the front seats and the airbag deployment zone. Make sure that children and passengers also keep to this rule.
- The built-in coat hooks should only be used for lightweight clothing. Do not leave any heavy or sharp objects in the pockets.
- Do not fit any accessories to the doors.
- Do not fit seat covers or protective covers over the seats unless they have been expressly approved for use in the vehicle. Otherwise the side airbag may not be able to inflate once triggered.

WARNING

Incorrect use of the driver and front passenger seat could hinder the proper function of the side airbag and cause serious injury.

- Never remove the front seats from the vehicle or alter any components of these seats.
- If too much pressure is applied to the backrest side bolster, the side airbags may not be triggered correctly, may not trigger at all, or may trigger unexpectedly.
- Any damage to the original seat upholstery or around the seams of the side airbag units must be repaired immediately by a qualified workshop.

Combined curtain and side airbags

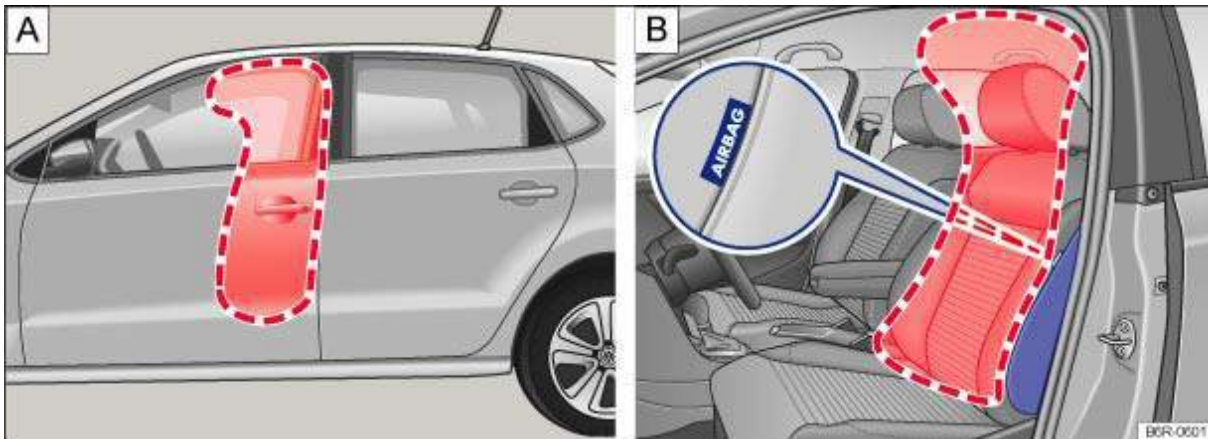



Fig. 64 A: on left-hand side of vehicle: deployment zone of the combined curtain and side airbags. B: on the side of the front seat: location and deployment zone of the combined curtain and side airbag



First read and observe the introductory information and safety warnings →  [Introduction](#)

The combined curtain and side airbags are located in the outer seat backrest cushions → [Fig. 64 B](#) of the driver seat and front passenger seat. The locations of the airbags are shown by labels with the word AIRBAG.

The areas outlined in red → [Fig. 64](#) are inside the deployment area of the combined head/side airbags. You must never leave or attach any objects in these areas → .

During a side collision, the combined curtain and side airbags will be deployed on the vehicle's side of impact, reducing the risk of injury to the areas of the vehicle occupants' bodies facing the impact.



WARNING

Once triggered, the airbag inflates at high speed.

- Always keep the deployment zones of the combined curtain and side airbags clear.
- No other people, animals or objects may be carried between the occupants of the front seats and the airbag deployment zone. Make sure that children and passengers also keep to this rule.
- The built-in coat hooks should only be used for lightweight clothing. Do not leave any heavy or sharp objects in the pockets.
- Do not fit any accessories to the doors.
- Do not fit seat covers or protective covers over the seats unless they have been expressly approved for use in the vehicle. Otherwise the combined combined curtain and side airbags may not be able to deploy if it has been triggered.



WARNING

Incorrect use of the driver and front passenger seat could hinder the proper function of the combined curtain and side airbags and cause serious injury.

- Never remove the front seats from the vehicle or alter any components of these seats.
- If too much pressure is applied to the backrest side bolster, the combined curtain and side airbags may not be triggered correctly, may not trigger at all or may trigger unexpectedly.
- Any damage to the original seat upholstery or around the seams of the combined curtain and side airbag units must be repaired immediately by a qualified workshop.

Curtain airbags

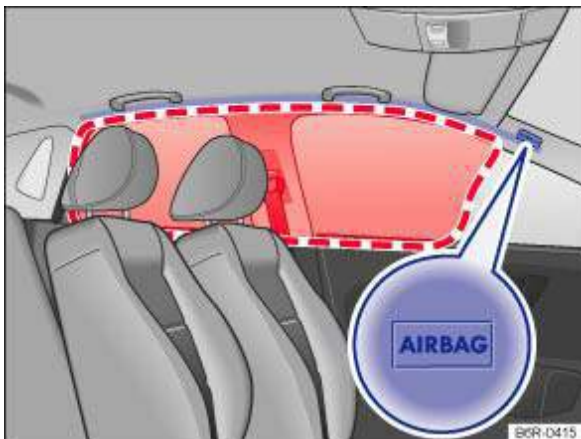



Fig. 65 On the left-hand side of the vehicle: location and deployment zone of the curtain airbag



First read and observe the introductory information and safety warnings → *Introduction*

In the interior, a curtain airbag is fitted above the doors on both the driver and front passenger sides → Fig. 65. The airbag location is identified by the text AIRBAG.

The area in the red frame → *Fig. 65* is covered by the curtain airbag when triggered (deployment zone). For this reason, you must never leave or attach any items in this area → .

In a side collision the curtain airbag is triggered on the impact side of the vehicle.

In a side collision, the curtain airbags reduce the risk of injury to the areas of the body facing the impact for vehicle occupants on the front seats and outer rear seats.



WARNING

Once triggered, the airbag inflates at high speed.

- Always leave the deployment zones of the curtain airbags clear.
- Never secure any items to the cover or in the deployment zone of the curtain airbag.
- Vehicle occupants sitting on the front seats and rear outer seats must never carry any people, pets or objects in the deployment zone between themselves and the airbags. Make sure that children and passengers also keep to this rule.
- The built-in coat hooks should only be used for lightweight clothing. Do not leave any heavy or sharp objects in the pockets.
- Do not fit any accessories to the doors.
- Do not install any sunblinds onto the side windows unless they have been expressly approved for use in your vehicle.
- Only push the sunblinds over to the side windows if no items are attached to them (e.g. pens or the remote control for a garage door).

Child seats

Introduction

This chapter contains information on the following subjects:

- *Basic information on fitting and using child seats*
- *Types of child seat*
- *Securing systems*
- *Securing a child seat with ISOFIX*
- *Securing child seats with the upper strap (top tether)*
- *Securing child seats with a seat belt*

Using child seats can reduce the risk of injury to the child if there is an accident. Always use child seats when driving with children.

Note the following:

- Child seats are classified into groups depending on the size, age and weight of child for which they are designed.
- Various securing systems are used to secure child seats in the vehicle.

For safety reasons child seats should always be fitted to the rear seats. They should only be fitted to the front passenger seat in exceptional cases.

Volkswagen recommends child seats from the Volkswagen range of accessories. These child seats have been developed and approved for use in Volkswagen vehicles.