



**TATA MOTORS**



# Indigo/Indigo CS

(TCIC / COMMON RAIL / MPFI)

BS-III & BS-IV

**OWNER'S MANUAL & SERVICE BOOK**

## CAR IDENTIFICATION AND RECORD :

OWNER'S NAME : \_\_\_\_\_

ADDRESS : \_\_\_\_\_

SELLING DEALER CODE : \_\_\_\_\_

DATE OF DELIVERY : \_\_\_\_\_

DATE OF REGISTRATION : \_\_\_\_\_

REGISTRATION NO. : \_\_\_\_\_

CHASSIS NO. : \_\_\_\_\_

ENGINE NO. : \_\_\_\_\_

TRANSAXLE NO. : \_\_\_\_\_

BATTERY MAKE : \_\_\_\_\_

BATTERY SR. NO. : \_\_\_\_\_

BATTERY CODE : \_\_\_\_\_

**THE WARRANTY ON THIS CAR IS VALID ONLY IF THE DETAILS ARE FILLED, SIGNED AND STAMPED BY THE SELLING DEALER**

**DEALER'S SIGNATURE  
AND STAMP**



### **Following items are provided with your TATA Indigo :**

1. Owner's Manual & Service Book
2. Battery Warranty Card
3. First Aid Kit
4. Advance Warning Triangle
5. Jack and Handle
6. Spare Headlamp bulbs - 2 Nos.
7. Spare Fuses - (Provided in fuse box)
8. Tool Kit
  - a. Wheel Spanner
  - b. Screw Driver
  - c. Open end spanner (8-10)
  - d. Adjustable Plier
  - e. Tubular Spanner (10-11)



# Tata Indigo & Indigo CS

TC / COMMON RAIL / MPFI

(BS-III & BS-IV)

## OWNER'S MANUAL & SERVICE BOOK

**TATA MOTORS**

Passenger Car Business Unit

● Mumbai ● Pune ●

This owner's manual is advised to be kept in the vehicle at all times.

- Should any question or query exist regarding any aspect of your car, please contact the nearest **TATA MOTORS** dealer, who will be pleased to assist wherever possible.
- The recommended routine maintenance servicing along with any running repairs that may be required, should be entrusted to **TATA MOTORS** dealership or to **TATA Authorised Service centres (TASCS)** or **TATA Authorised Service Points (TASPS)** to ensure that only latest methods and genuine **TATA MOTORS** replacement parts are used for the continued reliability, safety and performance of the vehicle.
- Copyright 2004 **TATA MOTORS**
- All rights reserved. The material in this manual may not be reproduced or copied, in whole or in part, in any form without written permission from **TATA MOTORS**.
- In the event of the Vehicle being sold, please ensure that this manual is left in the vehicle for the reference of the new owner.

This owner's manual & service book includes information on the operation and maintenance of various equipment installed on the different versions of **Tata Indigo**. Please note that this manual applies to all the models and explains all equipment including options not installed on your car.

*Dear Indigo Customer,*

*Thank you for choosing the Tata Indigo Sedan - another quality offering from our growing range of passenger cars.*

*We would request you to be acquainted with the details in this owner's manual, which will enable you to derive optimum performance from your Indigo. We look forward to having you as a satisfied customer and hope to have you retain us as your first choice for any of your motoring needs.*

*We are privileged to have you as our customer.*







# Contents

<b>INTRODUCTION</b>	<b>3</b>
<b>24 X 7 ON ROAD ASSISTANCE</b>	<b>9</b>
<b>VALUE ADDED SERVICE</b>	<b>13</b>
<b>TAKING CARE OF THE ENVIRONMENT</b>	<b>23</b>
<b>WARRANTY</b>	<b>25</b>
<b>INFORMATION AT A GLANCE</b>	<b>27</b>
<b>BEFORE DRIVING</b>	<b>31</b>
<b>STARTING &amp; DRIVING</b>	<b>79</b>
<b>MAINTENANCE &amp; CAR CARE</b>	<b>97</b>
<b>EMERGENCY SERVICE TIPS</b>	<b>130</b>
<b>IMPORTANT INFORMATION</b>	<b>141</b>
<b>CUSTOMER SUPPORT NETWORK</b>	<b>161</b>

**TATA MOTORS**

*Rely on us... always.*

**Call Us : 1 800 209 7979**

**Mail Us : [customercare@tatamotors.com](mailto:customercare@tatamotors.com)**

**Visit Us : [www.customercare.tatamotors.com](http://www.customercare.tatamotors.com)**



### Safety and vehicle damage warnings

In this manual, you will see CAUTION and NOTICE warnings.

#### CAUTION

This is a warning. May cause injury to people if the warning is ignored. You are informed what you must or must not do in order to avoid or reduce the risk to yourself and other people.

#### NOTICE

This is a warning. May cause damage to the vehicle or its equipment if the warning is ignored. You are informed what you must or must not do in order to avoid or reduce the risk of damage to your vehicle and its equipment.

#### WARNING

Indicates a strong possibility of severe personal injury or death if the instructions are not followed.

### Safety symbol

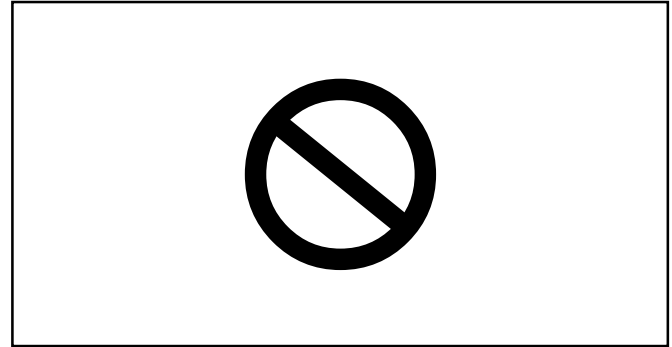

In this manual, you will also see a circle with a slash. This means "Do not", "Do not do this", or "Do not let this happen".

## IMPORTANT INFORMATION FOR OWNERS

---

The information and specifications given in this book are valid as on the date of printing. Tata Motors reserves the right to make changes in design and specifications and/or to make additions to or improvements in this product without obligation to install them on products previously sold.



**Dear Customer,**

It is our responsibility and our endeavour to ensure that you have our complete service backup if ever, wherever and whenever you need the same. When you have a road network that spans 33.80 kms, the probability of a breakdown happening within hailing distance of a **TATA MOTORS** Authorized Workshop is very low. It is Precisely for this reason, we have tied up with MyTVS, who will provide breakdown assistance including towing to the nearest **TATA MOTORS** Authorized Workshop through their Authorized Service Providers (ASP)

The **24X7 On Road Assistance** Program shall be automatically available to your vehicle for the duration of Warranty period. The program shall also be available for Extended Warranty period if you avail the same at the time of buying of your vehicle.

### Response Time \*\* for the On Road Assistance Program

Within City Limits	60 minutes
On State or National Highways	90 minutes
Ghat Roads and other places	120 minutes +/-

(The response time will depend on the location, terrain, traffic density and the time of the day.)

### Standard procedure when calling for On Road Assistance in case of a breakdown :

- Dial the toll free help line number – **1 800 209 7979**
- Identify your vehicle with the Vehicle chassis number that is available in the Owners Service manual or on the Helpline sticker on the dashboard, near the steering wheel.
- Explain your exact location with landmarks and tell us about the problem you face with the vehicle.
- Park your vehicle on the edge of the road, open the bonnet and put on the hazard warning signal.
- Place the caution sign supplied with the vehicle approx. 3 m from the vehicle in the direction of on coming traffic.

## 24 X 7 ON ROAD ASSISTANCE

---

### Coverage under the 24 X 7 On road Assistance Program

I. The **24x7 On Road Assistance** Program Service covers the following services on your vehicle during warranty period.

- Wheel change through spare wheel.
- Arrangement of fuel. (Fuel cost will be chargeable at actual cost)
- Re-opening the vehicle in cases of key lock out.
- Rectification of electrical problems related to battery, fuses etc.
- On spot repairs for complaints repairable at site. ^
- Car to car towing or winching & towing for non accident cases up to a maximum of 15 kms to the nearest Tata Motors authorized workshop. Towing charges at actual cost beyond the same to be paid to the ASP in cash. (Any ferry or toll charges levied in relation to the vehicle being towed to be paid by the customers in actuals in cash).

II. The **24x7 On Road Assistance** Program coverage as indicated above during the extended warranty period of your vehicle is up to a maximum of 3 events for 18/12 months extended warranty period & 4 events for 30/24 months extended warranty period.

III. The **24x7 On Road Assistance** Program as indicated above covers Tata Motors Assured vehicles during the extended warranty period up to a maximum of 3 events.

### Exclusions

#### **24x7 On Road Assistance Program does not apply to**

- Cost of parts consumables and labour for such repairs not covered under warranty\*. These charges are to be settled with ASP in cash.
- Toll or ferry charges paid by ASP in reaching to the breakdown site to be settled with ASP in actuals in cash.
- Cases involving accident, fire, theft, vandalism, riots, lightning, earthquake, windstorm, hail, tsunami, unusual weather conditions, other acts of God, flood, etc.
- Vehicles that are unattended, un-registered, impounded or abandoned.
- Breakdown/defects caused by misuse, abuse, negligence, alterations or modifications made to the vehicle.
- Lack of maintenance as per the maintenance schedule as detailed in the owner's manual.
- Cases involving racing, rallies, vehicle testing or practice for such events.

### Disclaimer

- The service is not available in the states of Arunachal Pradesh, Assam (Except Guwahati City), Meghalaya, Manipur, Mizoram, Nagaland, Sikkim, Tripura, J&K and in Union Territories of Andaman & Nicobar Islands and Lakshwadeep.
  - \*\*The reach time is indicative & the actual reach time will be conveyed by the call centre at the time of breakdown call.
  - The reach time can vary depending on the traffic density & time of the day.
  - The reach time indicated does not account for delays due to but not limited to acts of God, laws, rules & regulations for time being in force, orders of statutory or Govt. authorities, industrial disputes, inclement weather, heavy down pour, floods, storms, natural calamities, road blocks due to accidents, general strife and law & order conditions viz. fire, arson, riots, strikes, terrorist attacks, war etc.
  - ^ On spot repairs at breakdown site shall depend on nature of complaints & will be as per the discretion of the ASP.
- \*The decision for free of charge repairs will be as per the warranty policy & procedures of **TATA MOTORS LTD.** and as per the interpretation of the same by ASP. You will be duly informed by the ASP & call centre for the change applicable if any.
  - All charges wherever applicable need to be settled directly with the ASP.

## 24 X 7 ON ROAD ASSISTANCE

---

### EXCLUSION OF LIABILITIES :

- It is understood that **TATA MOTORS** shall be under no liability whatsoever in respect of any loss or damage arising directly or indirectly out of any delay in or non delivery of, defect/deficiency in service/parts provided by ASP.
- In case vehicle cannot be repaired on-site, customers are advised to use the towing facility for taking their vehicle to the nearest **TATA** authorized workshop only. In no condition will the vehicle be towed to any unauthorized workshop. **TATA MOTORS** will not be responsible for any repairs carried out in such unauthorized workshop.
- Customer are advised to take acknowledgment from the ASP for the list of accessories/extra fittings and other belongings in the vehicle as well as the current condition related to dents/scratches break-ages of parts/fitments of the vehicle at the time of ASP taking possession of the vehicle & to verify these items when delivery is taken back by them, Claim for loss of or damage to items, if any should be taken up with ASP directly. **TATA MOTORS** shall not be responsible for any such claims, damages/loss or any deficiency of service of the ASP.
- Vehicles will be handled, repaired & towed as per the customer's risk & **TATA MOTORS** shall not be liable for any damages / claims as a result of the same.
- Services entitled to the customers can be refused or cancelled on account of abusive behaviour, fraudulent representation, malicious intent and refusal to pay the charges for any charges related services and spare parts during service or on previous occasion on part of the customer.
- On site repairs may be temporary in nature. The completion of repairs does not certify the road worthiness of the vehicle. The customer is advised to ensure temporary repairs carried out onsite is followed by permanent repairs at **TATA MOTORS** Authorized Workshop at the earliest.
- Terms and conditions and service coverage, exclusions etc. are subject to change without notice.

*Dear Customer,*

*It is our never ending responsibility and endeavor to ensure that our customer's expectations are fulfilled comprehensively. To fulfill your vehicle service needs, we recommend the following :*

- 1) Extended Warranty*
- 2) Anti Rust / Sound Deadening / Engine waxing treatment*
- 3) Iftex Fuel Additive : System D (For diesel) and System G (For Petrol)*
- 4) Car detailing programming : Exterior Enrichment and Interior Enrichment Program*

*These products shall help maintain optimum vehicle performance and shall enhance vehicle life.*

*We have tied up with best in the Class companies, who would bring you the above world class products at affordable prices. The above products are available with all our Dealers, TASCs and TASP.*

*Our Dealer Service marketing executive shall explain to you the benefits of the above mentioned products.*



## VALUE ADDED SERVICE

---

**Tata Motors** recommends the purchase of Extended Warranty, a product of **M/s Global Administration Services and United India Insurance.**

**Coverage :** Mechanical + Electrical + Emission

**Benifits :**

- Insures you against unforeseen break down repair bills.
- Documentation is simple and hassle free.
- Near cashless & speedy claim settlement.

**Term :**

- **24 + 12 or 150000 kms** whichever occurs first
- **24 + 24 or 150000 kms** whichever occurs first
- **50000 kms + 100000 kms** or **36 months** whichever occurs first **(For Taxis).**

**EMISSION WARRANTY :** Emission warranty is limited to the period of the **Extended Warranty** or **80,000 kms** whichever is earlier.

**Extended Warranty** available in the dealership from where you have purchased your vehicle. We strongly recommend purchase of Extended Warranty at time of purchase of your vehicle. Surcharge applicable on purchase of Extended Warranty after 30 days of purchase of vehicle. **Extended Warranty can be availed till 421 days from date of purchase of vehicle.** The Dealer Service Marketing Executive shall explain to you the Terms and conditions, Coverage and Owner's responsibility.

**Extended Warranty Booklet & Cover Note :**

The Extended Warranty booklet and cover note is the basis of the contract between United India Insurance Co. and the Owner of the vehicle shown on the Extended Warranty Cover note. The Customer to retain this booklet and the same to be produced to the dealer while claiming benefits under Extended Warranty.





**Note :**

- The 12 / 24 month extended warranty does not follow the 24 month Manufacturer's warranty.
- The extended warranty comes into force once the manufacturer's warranty expires e.g. after 24 Months.
- It is more restrictive as by the time it comes into force the vehicle is already 24 months old.

**What is covered ?**

- Mechanical / Emission / Electrical break down as defined in this warranty and confirmed by the dealer within the stipulated terms and conditions.
- Tata Motors dealer shall either repair or replace any part found to be defective with a new part or an equivalent at no cost to the owner for parts or labour.
- Such defective parts which have been replaced will become property of United India Insurance Company.
- Comprehensive list of parts covered is mentioned in the page 9-12 of the Extended Warranty Booklet.

**What is not covered ?**

Pages 6 – 7 of the Extended Warranty Booklet provided details of the exclusion list.

**Owner's Responsibility :**

- Proper use, maintenance and care of the vehicle in accordance with the instructions contained in the Owner's Manual and Service Booklet. The records of the same to be ensured in Owner's Manual.
- Retention of maintenance service bills.
- Always produce extended warranty booklet while servicing & claim in a warranty.

---

I / We have been explained the Terms and conditions, Coverage and Owner's responsibility by the Dealer Service Marketing Executive.

I wish to avail /  Do not wish to avail extended warranty policy.

---

**Customer's Sign**

---

**Dealer's Sign**

## VALUE ADDED SERVICE

---

### IFTEX / BG / BARDAHL Fuel Additive :

#### *Fuel Additive with multiple benefits*

- For diesel cars: Iftex System D
- For Petrol cars: Iftex System G

#### **Benefits:**

- Cleans injector and fuel system.
- Maintains peak engine performance.
- Saves diesel / petrol and maintenance cost.
- Reduces smoke and harmful emission.
- Helps Smooth running of the engine
- Reduces deposit on intake manifold and combustion chamber.
- Reduces deposit on injector tips.



**Approved for use in TATA VEHICLES. NOT RECOMMENDED FOR ON QUADRAJET.**

**TREAT YOUR CAR TO EXPERIENCE, THE ULTIMATE PERFORMANCE**

#### **Directions of use :**

- a) For Iftex, Use every 7000 kms for System G Extra / System D Extra. b) For System D / System G - Remove cap, squeeze lightly till dispenser fills to 10 ml mark. Add before filling up the tank. Use at the rate of 1 ml per litre of fuel. For best results, regular use is recommended.
- For BG, add one bottle to full fuel tank every 10000 kms. For Bardahl, add one bottle to full fuel tank every 3000 kms

---

I / We have been explained the Benefits of the Iftex Fuel additive by the Dealer Service Marketing Executive

I wish to buy /  Do not wish to buy the Iftex Fuel Aditive

\_\_\_\_\_  
**Customer Signature**

\_\_\_\_\_  
**Dealer Signature**

### Why are Corrosion Protection Waxes necessary?

#### ***Corrosion is caused by:***

Water / salt water acid rain & atmospheric fallouts.

#### ***Critical areas are:***

Cavities: joints, crevices, spot welds, underbody

- Corrosion is the most important factor when we talk about the vehicle life. If you treat your car you can prolong the life.
- It is very dangerous to drive around in a corroded car.
- The corrosion creeps onto the car from the inside and from the outside. The most dangerous kind of corrosion is often not discovered until it is too late.

#### ***Benefits of Anti -Rust treatment :***

- A professionally applied range of world class products offering real value to the new and used car customer.
- The treatment has been developed to withstand the harshest environmental and climatic conditions (rst. Pollutants, stone and gravel impact, etc)
- Insulate cabin space from external noises.
- Expensive tin work and Denting / Painting avoided.
- Higher resale value for the car.
- Higher safety – uncorroded vehicle
- Upto 60 months warranty & 10 free checkups available



## VALUE ADDED SERVICE

---

### Engine Wax Treatment :

Engine Wax is a beige coloured transparent lacquer coating on the engine compartment.

- Corrosion Prevention for the Engine compartment
- Neat, clean and New Look to Engine compartment
- No effect on MPFI vehicles
- Engine wax can withstand upto 200 degrees temp
- No need of cleaning the engine compartment with diesel once engine wax is sprayed
- Life of over a year

### Sound Deadening System :

Door vibration deadeners - These pads when stuck on the insides of the sheet metal increase sheet metal rigidity, reduce vibrations and increase riding comfort.

- Used for reducing the sheet metal vibration in a vehicle.
- Product to be used once in the life of the vehicle - Life Time Warranty
- Effect is Life long i.e. until & unless pads are physically removed.
- Negligible increase in Weight & hence no effect on fuel consumption.
- Areas covered - four doors, rear quarter panels & dicky. In case of diesel vehicles, can be used in the bonnet.

**Tata Motors** has tied up with **M/s Wuerth** , **M/s STS Chemicals (Dinitrol)**, **M/s 3M India Ltd** & **M/s Opulent (Waxoyl Brand)** for these world class treatment at affordable prices. These treatments are available in all authorized workshops. The Dealer Service Marketing Executive will explain to you the benefits and terms and conditions of this treatment.

---

I / We have been explained the Benefits, Terms and conditions and the prices of these treatments by the Dealer Service Marketing Executive

I wish to avail /  Do not wish to avail these treatment

\_\_\_\_\_  
Customer Signature

\_\_\_\_\_  
Dealer Signature

### Vehicle Exterior Enrichment :

#### *Why vehicles are painted?*

- For Corrosion protection of the metal surfaces.
- Ease of application from other corrosion protection treatments.
- Cheaper than other corrosion protection methods eg.galvanizing, anodizing.
- For decoration and identification.

#### **Various Environmental Hazards affecting paints :**

- Environmental hazards: destroy your vehicle's finish.
- Even as your new vehicle rolls off the assembly line, the paint is not protected.

#### **The enemy :**

Ultraviolet Rays, Pollution, Tree Sap, Bird Droppings, Car Wash Chemicals, Road Salt, Acid Rain.

#### **Benefits:** Vehicle Exterior Enrichment

- Removal of medium scratches, orange peel, oxidation , dust nibs etc & swirl marks from painted surface.
- Restoration of original gloss levels UV protection after gloss is restored.
- Cleaning & dressing of tyres, Bumpers & all exterior plastic moldings/trims.

**Tata Motors** has tied up with **M/s Opulent (Waxoyl brand) M/s 3M & M/s Wuerth** for this world class treatment at affordable prices. This treatment is available in all authorized workshops. The Dealer Service Marketing Executive will explain to you the benefits and terms and conditions of this treatment.



3M Car Detailing™

## VALUE ADDED SERVICE

---

### Vehicle Interior Enrichment

#### *Why protect your new car's fabric interior ?*

- Someone will soil your vehicle's fabric carpet or seats.
- A significant detractor from your vehicle's resale value.
- A permanent stain on your vehicle's interior fabric.

#### **The enemy :**

Drink Spills - Food Stains - Mud - Ultraviolet Rays Pets - Traffic

#### **Benefits:** Vehicle Interior Enrichment

- Removal of medium stains and dirt from all interior parts of the car i.e carpet, upholstery and roof lining.
- Cleaning of windshield and all windows (inside and outside)
- Dressing of all internal plastics (eg: door pad trims )and rubber parts.
- The treatment involves cleaning and dressing of All parts of the exposed interiors.
- Specialised protection for seat fabric from liquid spills.

**Tata Motors** has tied up with **M/s Oplent (Waxoyl brand and M/s 3M** for this world class treatment at affordable prices. This treatment is available in all authorized workshops. The Dealer Service Marketing Executive will explain to you the benefits and terms and conditions of this treatment.

---

I / We have been explained the Terms and conditions, Coverage and Owner's responsibility by the Dealer Service Marketing Executive.

I wish to avail /  Do not wish to avail extended warranty

---

**Customer's Sign**

---

**Dealer's Sign**

### Why de-carbonisation is required?

Carbon deposits accumulate over time in the entire fuel system, including the fuel lines, injector pump, fuel injectors, combustion chambers & intake valves. This causes rough idle, vibration at idle, loss of power, hesitation, misfire, decreased mileage, increased smoke, slowed throttle response.

Decarbonisation process is designed to remove these deposits

- Clean fuel injectors
- Clean throttle body
- Clean plenum and air-intake
- Clean intake valves and ports
- Remove combustion chamber deposits
- In maintaining correct balance of fuel and air in system



### Resulting in

- Comprehensive clean-up of combustion chamber, induction system & fuel injector deposits
- Better fuel economy
- Increased engine performance and response
- Smooth Starts, idles and quieter run
- Better combustion & increased power
- Faster starting & warm-up
- Reduced emissions
- Reduced injector & pump wear, thereby resulting in savings in maintenance costs

It is approved for low sulphur diesel fuel and EGR equipped diesel engines

**Please note:** These are symptomatic treatments to be availed beyond 20000 kms and only when you have problems in your car as mentioned in first paragraph and are to be done only after **you give your consent** for carrying out these treatments

## VALUE ADDED SERVICE

---

### Engine Flush treatment helps in

- Safely and effectively cleaning and removing oxidised particles and fluid contamination left behind from previous oil changes
- Preventing further deposits
- Freeing sticky lifters and rings
- Chemically "tuning" the engine during driving
- Restoring pep and power
- Removing sludge from valve train
- Promoting fuel economy and improving overall engine operation

### Special Products used for improving Compression

To fortify new oil and seal rings for optimum performance, special products from BG (RF7) and Bardhal (Special Duty) are added to new engine oil. This makes it suitable for petrol and diesel engine applications

### Resulting in:

- Improved engine compression
- Increased power and increased fuel economy
- Reduced start-up wear
- Increased engine life, especially under severe service conditions
- Reduced emissions and oil consumption
- Improved power & performance of older engines
- Prevention of sludge, gum and varnish formation on engine parts both petrol & diesel engines

**Please note:** These are symptomatic treatments to be availed beyond 20000 kms and only when you have problems in your car as mentioned in first paragraph and are to be done only after you give your consent for carrying out these treatments

Tata Motors has tied up with **M/s HOEC Bardahl India Ltd and BG** for these world class treatment at affordable prices. These treatments are available in all authorized workshops. The Dealer Service Marketing Executive will explain to you the benefits and terms and conditions of this treatment.

---

I / We have been explained the Benefits, Terms and conditions and the prices of these treatments by the Dealer Service Marketing Executive

I wish to avail /  Do not wish to avail these treatment

---

**Customer's Sign**

---

**Dealer's Sign**



### Taking care of the Environment

Tata Motors is committed to producing cars using environmental friendly technology. A number of features have been incorporated in our passenger cars which are specifically designed to ensure environmental compatibility throughout the life cycle of the car. We would like to inform you that your car meets emission norms and is being regularly validated at the manufacturing stages to keep up with the stringent emission norms.

As a user you too can protect the environment by operating your car in a proactive manner. A lot depends on your driving style and the way you maintain your car. Listed below are few tips that will help you do so.

#### WHILE DRIVING :

- Avoid frequent and violent acceleration.
- Do not carry any unnecessary weight on the vehicle as it overloads the engine.
- Avoid using devices requiring high power consumption during slow traffic condition.

- Monitor the car's fuel consumption regularly. If it shows a rising trend get the car immediately attended to at the Company's Authorised Service Centre.
- Switch off the engine during long stops at traffic jams or signals. If you need to keep the engine running, avoid unnecessary revving or stopping and starting.
- It is not necessary to rev up the engine before turning it off as it unnecessarily burns the fuel.
- Shift to higher gears as soon as it is possible. Use each gear upto 2/3<sup>rd</sup> of it's maximum engine speed. A chart indicating gear shifting speeds is given in this book.

#### MAINTENANCE OF THE CAR :

- Ensure that recommended maintenance is carried out on the car regularly at the Tata Motors Authorised Service Outlets.
- As soon as you notice any leakage of oil or fuel in the car we recommend that you get it attended immediately.
- Use only recommended brands and grades of lubricants & coolants and clean/uncontaminated fuels.

## ENVIRONMENT PROTECTION

---

- Get your vehicle checked for emission periodically by our authorised dealer and regularly renew the P.U.C. Certificate.
- Ensure that fuel filter, oil filter, breathers are periodically checked and if required, replace the same using only genuine recommended brands.
- Do not pour used oils or coolants into sewage drains, garden soil or open streams. Dispose of the used filters and batteries in compliance with the current legislation.
- Do not allow any unauthorised person to tamper with the engine settings or to carry out modifications on the car.
- Never allow the vehicle to run out of fuel. This will result in misfiring of the engine and could cause harm to the catalytic converter.
- Parts like brake liners and clutch disc should be vacuum cleaned. Do not use compressed air for cleaning these parts which may spread the dust in the atmosphere.

While carrying out the servicing or repairs of your car, you should pay keen attention to some of the important engine aggregates which greatly affect emission. These components are :

- 1. Fuel injection pump , Injectors / Nozzles**
- 2. Air intake & Exhaust system especially for leakage**
- 3. Cylinder head for valve leakage**
- 4. All filters such as air, oil & fuel filters (check periodically)**
- 5. Catalytic converter**
- 6. E.G.R. system (Diesel)**
- 7. Turbocharger & Intercooler (Diesel)**
- 8. Ignition System - Spark plug gap (Petrol)**

This Owner's Manual & Service Book contains further information on driving precautions and maintenance care leading to environment protection. Please familiarise yourself with these aspects before driving.

## WARRANTY - Terms & Conditions

We **WARRANT** each **Tata Indigo** car and parts thereof manufactured by us to be free from defect in material and workmanship subject to the following terms and conditions -

1. This warranty shall be for 18 months from the date of sale of the car irrespective of the distance covered. However, for the cars with yellow number plates used for commercial applications (including those used for hire or reward viz those operating with a yellow number plate), the warranty shall be limited to 18 months or 50,000 kms, whichever occurs earlier.
2. Our obligation under this warranty shall be limited to repairing or replacing, free of charge, such parts of the car which, in our opinion, are defective, on the car being brought to us or to our dealers within the period. The parts so repaired or replaced shall also be warranted for quality and workmanship but such warranty shall be co-terminus with this original warranty.
3. Any part which is found to be defective and is replaced by us under the warranty shall be our property.
4. As for such parts as tyres, batteries, electrical equipment, fuel injection equipment, etc. not manufactured by us but supplied by other parties, this warranty shall not apply, but buyers of the car shall be entitled to, so far as permissible by law, all such rights as we may have against such parties under their warranties in respect of such parts.
5. This warranty shall not apply if the car or any part thereof is repaired or altered otherwise than in accordance with our standard repair procedure or by any person other than from our sales or service establishments, our authorised dealers, service centres or service points in any way so as, in our judgement which shall be final and binding, to affect its reliability, nor shall it apply if, in our opinion which shall be final and binding, the car is subjected to misuse, negligence, improper or inadequate maintenance or accident or loading in excess of such carrying capacity as certified by us, or such services as prescribed in our Owner's Manual and Service Book are not carried out by the buyer through our sales or service establishments, our authorised dealers, service centres or service points.
6. This warranty shall not cover normal wear and tear or any inherent normal deterioration of the car or any of its parts arising from the actual use of the car or any damage due to negligent or improper operation or storage of the car. This warranty shall not

## WARRANTY - Terms & Conditions

---

apply to normal maintenance services like oils & fluid changes, head lamps focussing, fastener retightening, wheel balancing, tyre rotation, adjustment of valve clearance, fuel timing, ignition timing and consumables like bulbs, fuel filters & oil filters, etc. This warranty shall not apply to any damage or deterioration caused by environmental pollution or bird droppings. This warranty shall not apply to V-belts, hoses and gas leaks in case of air conditioned cars. Slight irregularities not recognised as affecting the function or quality of the vehicle or parts, such as slight noise or vibration, defects appearing only under particular or irregular operations are items considered characteristics of the vehicle.

7. This warranty shall be null and void if the car is subjected to abnormal use such as rallying, racing or

participation in any other competitive sport. This warranty shall not apply to any repair or replacements as a result of accident or collision.

8. This warranty is expressly in lieu of all warranties, whether by law or otherwise, expressed or implied, and all other obligations or liabilities on our part and we neither assume, nor authorise any person to assume on our behalf, any other liability arising from the sale of the car or any agreement in relation thereto.

9. The buyer shall have no other rights except those set out above and have, in particular, no right to repudiate the sale, or any agreement or to claim any reduction in the purchase price of the car, or to demand any damages or compensation for losses, incidental or indirect, or inconvenience or consequential

damages, loss of car, or loss of time, or otherwise, incurred or accrued.

10. Any claim arising from this warranty shall be recognised only if it is notified in writing to us or to our authorised dealer without any delay soon after such defects as covered & ascertained under this warranty.

11. This warranty shall stand terminated if the car is transferred or otherwise alienated by the buyer without our prior written consent.

12. We reserve our rights to make any change or modification in design of the car or its parts or to introduce any improvement therein or to incorporate in the car any additional part or accessory at any time without incurring any obligation to incorporate the same in the cars previously sold.

**TATA MOTORS**

## INFORMATION AT A GLANCE - Filling Station Information

ENGINE OIL UPTO DIPSTICK MAX.MARK ~ 5.5 Litres (DIESEL)  
ENGINE OIL UPTO DIPSTICK MAX.MARK ~ 4.0 Litres (PETROL)

FUEL TANK CAPACITY

42 Litres

\* Premixed ready to  
use Engine Coolant  
= 6 Litres

Windshield Washer  
reservoir = 3.5 Litres for LX /  
GLX and 1.5 Litres for L/GL,  
LE/GLE and LS/GLS

Brake fluid = 0.270 Litres

TRANSAXLE OIL

3.3 Litres

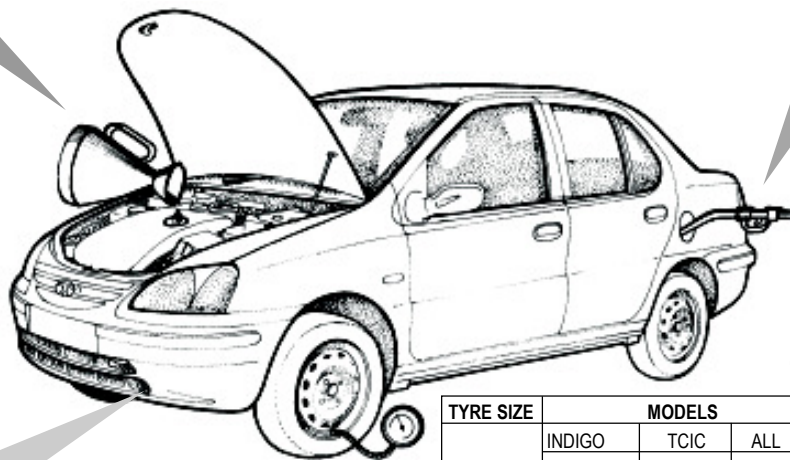

### TYRE PRESSURE

TYRE SIZE	MODELS			FRONT	REAR
175/65 R14	INDIGO	TCIC	ALL	27 psi (1.9 bar)	27 psi (1.9 bar)
	INDIGO	COM.RAIL	ALL	32 psi (2.2 bar)	29 psi (2.0 bar)
	INDIGO CS	TCIC/MPFI	LS/GLS	27 psi (1.9 bar)	27 psi (1.9 bar)
	INDIGO CS	COM.RAIL	LS/GLS	32 psi (2.2 bar)	29 psi (2.0 bar)
165/65 R14	INDIGO CS	TCIC/MPFI	LE/GLE	32 psi (2.2 bar)	29 psi (2.0 bar)

**IMPORTANT :** For fuel specification, please refer 'IMPORTANT INFORMATION - Fuel, Lubricants & Coolants' group (Page no. 138 & 139)

For recommended oil grades and change intervals, refer lubricants chart and Service Schedule.

\* If concentrated antifreeze agent is used, mix it with soft water in the ratio of 50:50.

## INFORMATION AT A GLANCE - Dimensions

### INDIGO

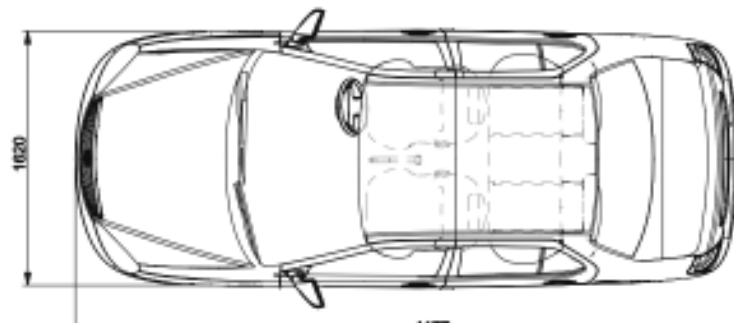
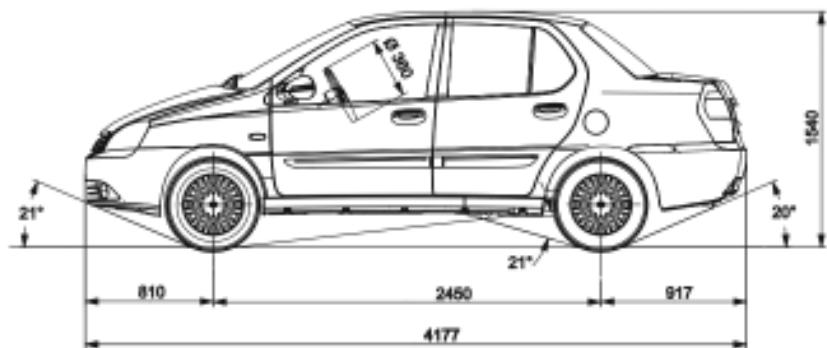

## INFORMATION AT A GLANCE - Dimensions

### INDIGO CS

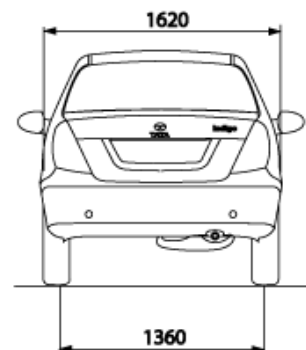
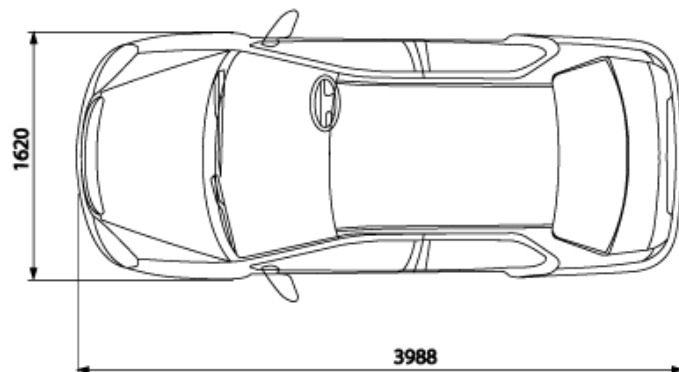
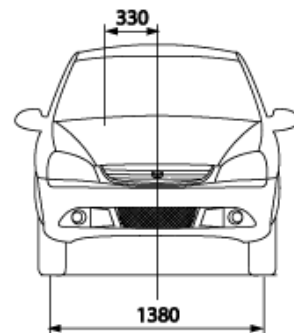
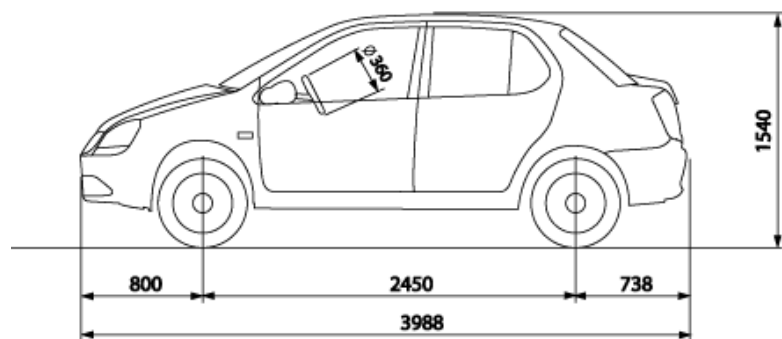





## ■ DRIVING CONTROLS

- Driving Controls
- Keys
- Door Locks
- Child Lock
- Steering cum Ignition Switch
- Combi-switch
- Accessory Switches
- Fog Lamps
- Gearshift Lever & Shifting Pattern
- Parking Brake

## ■ INSTRUMENT PANEL

- Instrument Panel
- Turn Signals & Hazard Warning
- Indicators
- Gauges
- Audio Warning
- Tail Lamp
- Registration Plate Lamp
- High Mounted Stop Lamp

## ■ HEATING, VENTILATION & AIR-CONDITIONING

- Air Flow Pattern
- Control Knobs

## ■ INTERIORS & ACCESSORIES

- Rear View Mirrors
- Motorised Rear View Mirror
- Inner Rear View Mirror
- Goggle Case
- Sunvisors
- Reflex Reflectors
- Glove Box
- Window Winding
- Power Windows
- Ashtray
- Analog Clock
- Digital Clock
- Roof Lamps
- Luggage Compartment Lamp
- Front Seat & Seat Adjustment
- Rear Seat & Rear Seat Folding
- Seat-Belt and Seat-Belt Adjustment
- Provision for music system
- Plug Socket
- Trunk lid Opening
- Fuel Flap Opening
- Side Utility Pocket
- Toolkit
- Jack

## BEFORE DRIVING - Driving Controls

---

### DRIVING CONTROLS

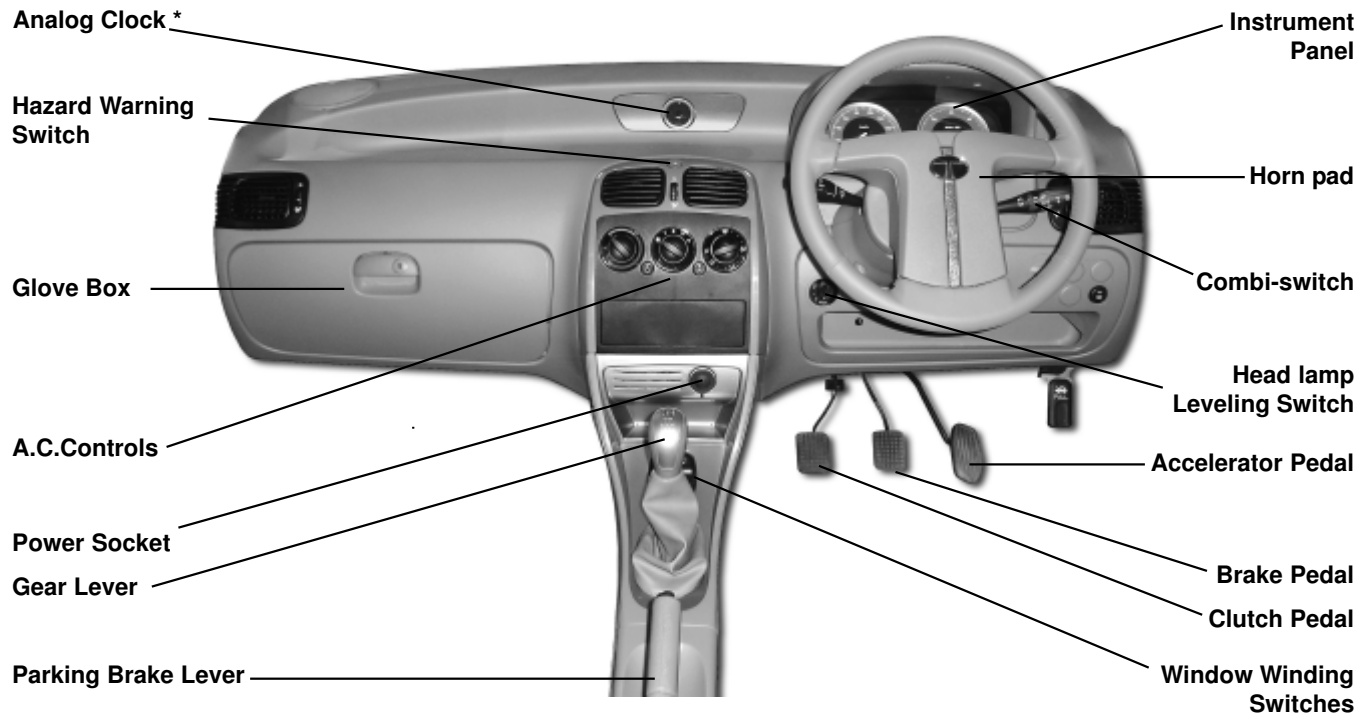

\* In few versions digital clock is provided

### Keys :

Your car comes with three identical keys. With this key, you can operate -

1. Door Locks
2. Steering Lock cum ignition switch
3. Trunk lid Lock
4. Glove box

It is advisable to keep one of the keys in a safe place for use in case of an emergency.

### NOTICE

- Do not use a locally made key, but obtain a duplicate through your Tata Motors dealer.
- Do not leave the key inside the car.

### Door Locks :

The front doors can be locked and unlocked from outside with the key or from inside using the door lock lever. In your car, the driver's door & co-driver's door have separate locking facilities. To lock from inside turn the lever towards the inner hinged handle.

Where the central locking system is provided, if you lock/unlock the driver door with the key, the remaining three doors get locked/unlocked at the same time. The trunk lid is not a part of the central locking provision.

To open the door from outside use the swing handle. After unlocking the door with the key, pull the swing handle upward. The swing handles are provided on each door.

To open the door from inside pull the hinged handle outward.

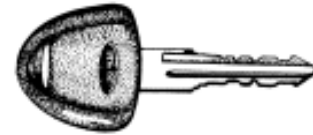

Outside swing handle

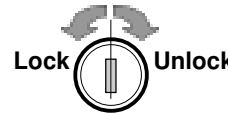

Locking /  
Unlocking lever

Hinged handle

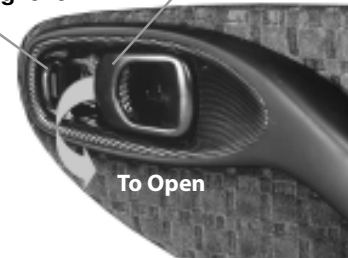

Inside door handle

## BEFORE DRIVING - Key & Door Locks

### IN CASE OF EMERGENCY

- 1) The electrically operated devices (like central locking, power windows) may malfunction in the event of flood / fire, because of temporary or permanent damage to the device. Exercise appropriate precautions for safety of yourself and other occupants.
- 2) If the central locking system malfunctions and is unable to unlock doors electrically, the door can still be opened by manually unlocking knob '1' and opening the door using lever '2'. The mechanical system overrides the electrically operated locking system.

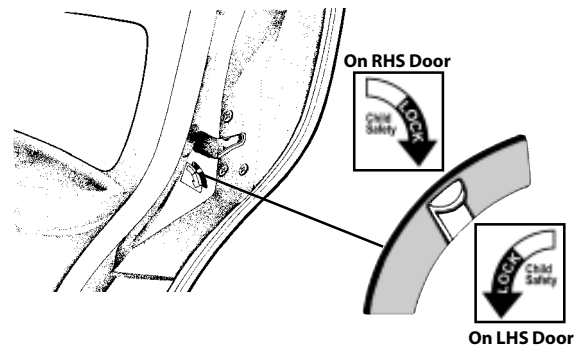

### Child Lock :

Both the rear doors of the car are provided with child locks. Push the lock lever located on the vertical face near the rear lock downward before closing the door. The door which has been locked can no longer be opened from inside.

It can be opened only from the outside.

When child lock on rear door is 'LOCKED' the door can only be opened from outside. Use front doors to exit or take help of front occupants.

### CAUTION

Deactivate the childproof lock when not required.

## BEFORE DRIVING - Remote Keyless Entry System

### REMOTE KEYLESS ENTRY SYSTEM: (if fitted)

This Remote Keyless Entry System has a keyless operation to unlock/lock the door.

#### 1.1 THE SYSTEM CONSISTS OF FOLLOWING:

1. Remote to **LOCK/UNLOCK** the door from a distance.
2. Hopped Coded Plug with **LEARN** and **UNLOCK** button (for Learning use).
3. Electronic Control Unit (ECU) fitted on the vehicle.
4. Code receiver antenna fitted for the system in the vehicle.

#### 1.2 FEATURES:

- Locking/ unlocking the vehicle from distant place. (Remote functioning range 7.5 meters max.)
- Finding the vehicle. (Refer car seek).
- Continuous flashing of turn indicators (refer Forced Panic Mode)
- Additional/ new remotes can be added. Lost/ Stolen remotes can be disabled.  
(Refer Learning Additional Remotes/ Unlearning Lost Remotes.)

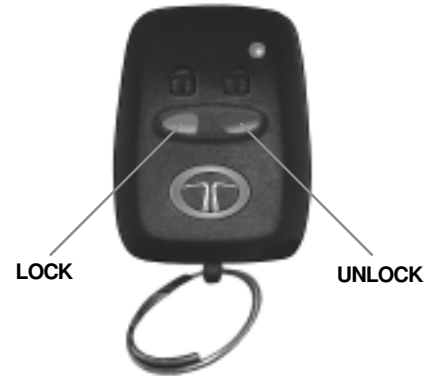

## BEFORE DRIVING - Remote Keyless Entry System

---

### 2.1. REMOTE KEYLESS ENTRY :

Your vehicle can be locked or unlocked using **LOCK / UNLOCK** remote buttons.

#### **UNLOCK:**

Press **UNLOCK** button on remote to unlock the driver door. Unlocking is indicated by one flash of turn indicator. Subsequent press of Unlock button will unlock other doors.

#### **LOCK:**

Press **LOCK** button on remote to lock the door.

From the outside of the car, press Lock button on Remote, All doors will be locked.

Successful locking will be indicated by two (2) flashes of Left and Right turn Indicator.

If any door is open, flashes are given for approximately 60 seconds indicating Door open, but lock the vehicle.

**NOTE :** Do not use remote to lock the doors from inside the vehicle. Use the door lock knob located on driver's door to lock the doors.

If the LOCK button of remote was pressed and the door is opened by the mechanical key OR the key is inserted in the ignition lock and turned to Ignition, then LH and RH turn indicators will start flashing for approximately 30 seconds and Lock  Symbol on instrument cluster will start flashing. Press **UNLOCK** button from

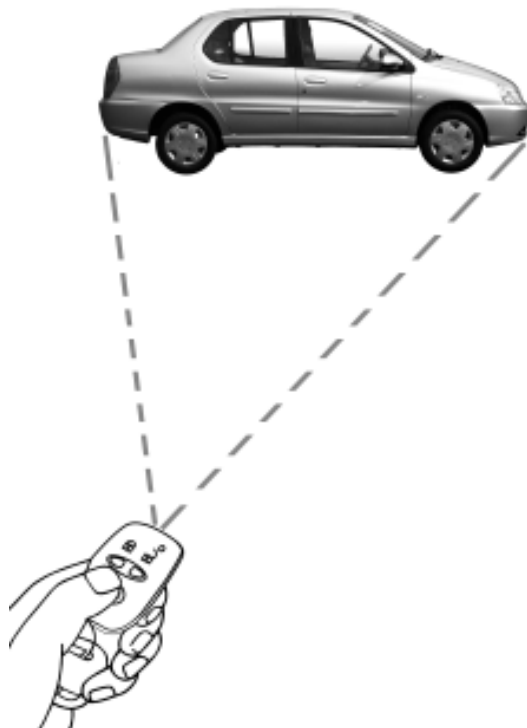

## BEFORE DRIVING - Remote Keyless Entry System

remote to stop flashing of turn indicators. Subsequent press of unlock button will stop flashing of Lock Symbol  and all doors will unlock. Use the door lock knob located on driver's door to lock the doors.

**LOCK** button does not work with mechanical key in ignition. Only **UNLOCK** button on the remote works with mechanical key in the ignition switch.

### 2.2. CAR SEEK:

Car seek function is used to find the vehicle.

Press **LOCK** button on remote when vehicle is locked. Vehicle turn indicators flashes thrice. Vehicle remains locked. (Remote functioning range 7.5 meters max.)

**NOTE :** The remote range may be affected / reduced in the vicinity of the Transmitting power stations. (e.g. TV Tower, etc.)

### 2.3. FORCED PANIC MODE :

When **LOCK** and **UNLOCK** buttons of remote are pressed simultaneously, turn indicators will start flashing continuously. To stop flashing press any **LOCK/UNLOCK** button.

#### CAUTION

This feature should be used in case of emergency as a hazard sign.



## BEFORE DRIVING - Remote Keyless Entry System

---

### 3.1. LEARNING ADDITIONAL REMOTES / UNLEARNING LOST REMOTES :

Every remote can be learnt or unlearnt using the Hopped Coded Plug.

Before use, every remote must be learnt.

1. Open the door with mechanical key; plug the Hopped Code Plug into the 6 pole connector on the Control Unit, located below the driver seat.
2. Press **UNLOCK** button on the Hopped Code Plug to unlock the vehicle.
3. Press **LEARN** button on the Hopped Code Plug. The system will erase all the pre-learnt remotes. The Lock Symbol on the dashboard starts blinking once per second (if no remotes are available for learning, press **UNLOCK** button on the Hopped Code Plug to terminate this session and whenever remotes are available start from step 1 .
4. Press the **LEARN** button on the Hopped Code Plug again. The Lock Symbol on dashboard remains "ON" for Four seconds and starts blinking at a faster rate. Ensure to perform step 5 within 25 seconds.
5. Press any button thrice on the remote that has to be learnt.

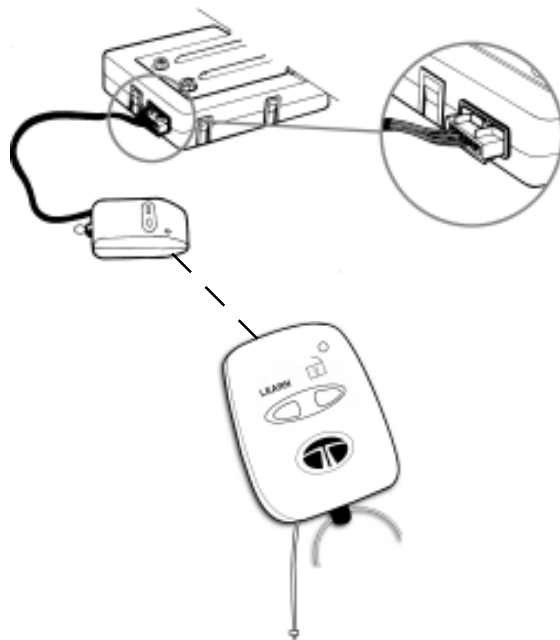



## BEFORE DRIVING - Remote Keyless Entry System

6. In response, Lock Symbol on the dashboard turns "ON" for Four seconds and starts blinking at slower rate (Once per second ) to indicate that the remote has been learnt successfully.
7. Repeat steps 4, 5, and 6 for learning additional new remote (Max 5 Numbers) or press **UNLOCK** button on the Hopped Code Plug to terminate the Learn session after step 6.
8. If step 5 is not performed within 25 seconds the vehicle will unlock all the doors and Learn procedure has to be started from step 2.

Ensure lost remotes are unlearnt immediately.

Ensure all remotes to be used are relearn again if step 3 is performed even once.

### 4.1. REPLACEMENT OF REMOTE BATTERY:

(Replace the battery every year for normal use)

1. Place the remote button-side facing down and remove the screw.
2. Remove bottom cover and change the battery with GOLDEN POWER battery GP 23A or equivalent (e.g.-Duracell MS21 / MN21)
3. Put back bottom cover and the screw.



## BEFORE DRIVING - Remote Keyless Entry System

---

4. Press any button and check that the LED on the remote glows, this ensures changed battery works successfully.

- **Battery Low Indication :**

Remote functioning range reduced. Replace the battery to get the correct range.

- Press any of the keys on remote, if LED of the remote is continuously 'ON', means battery is OK. If it is blinking, then remote battery is to be replaced.

## BEFORE DRIVING - Steering Lock cum Ignition Switch

### Steering lock cum ignition switch :

The steering column lock cum ignition switch has the following four positions and is operated with the key.

1. **LOCK POSITION** - The key can be inserted or taken out only in this position. When the key is removed from the switch, the steering is locked. To unlock the steering, insert the key and turn it to the 'OFF' (Steering unlock) position.
2. **'OFF' POSITION** - In this position, the steering lock opens and the music system is powered.

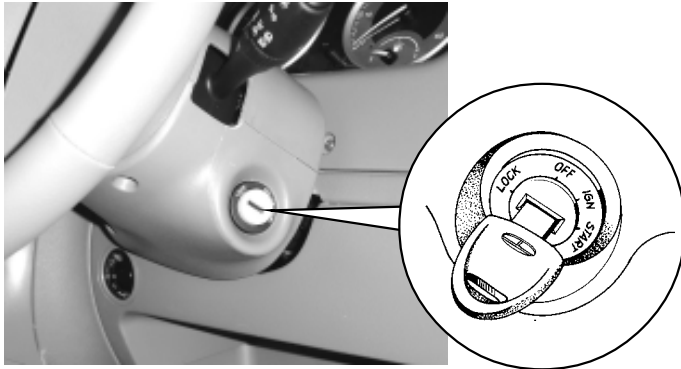

3. **'IGN' POSITION** - This is for switching on the power supply to the following items :

- Blower & A/C
  - Engine cooling fan
  - Horn
  - Power Socket
  - Power window
  - Head lamp leveling switch
  - Head lamps
  - Music system (if fitted)
  - Digital clock / Analog clock
  - Engine ignition, fuel supply and glow plug.
  - Turn signal lamps
  - Wash and wiper system
  - Reverse light
  - Instruments and gauges and tell tale warning lamps
  - Audio warning unit
  - Fog Lamps
- } Accessories supply

4. **'START' POSITION (Spring return to "IGN")** - In this position, which is momentary, the switch cranks the engine. When the switch is in this position the devices listed under "Accessories supply" above, are switched 'OFF'.

## **BEFORE DRIVING - Steering Lock cum Ignition Switch**

---

**The following items are operated/powered without the key in the ignition switch :**

Hazard warning system, Stop lamps, Position lamps, Registration lamps, Illumination of A.C. control panel and Instrument cluster, Switch symbol lamps, Roof lamp, Reading lamps, Engine lamp, Central door locking, Audio warning unit, Memory of digital clock and Music system.

### **NOTICE**

When the key is returned from 'OFF' position to LOCK position, the music system and the digital clock display continue to be powered until the key is removed from the switch. This also helps to remind the driver if the key is inadvertently left in the vehicle when alighting from the vehicle, where this is provided.

### **Instrument Panel Light Brightness Control (if installed)**

The brightness of instrument panel lights/A.C. Control panel back lights can be controlled by the thumb operated rotary knob which is located on the dashboard near the accessory switches.

### **⚠ CAUTION**

- I) Do not remove the key, while the car is in motion, as the steering will get locked and the car cannot be steered.
- II) While turning the key from 'LOCK' position to 'OFF' position slightly rotate steering wheel to relieve pressure on steering spindle for easy operation of the key. Also ensure the key is inserted fully before turning the key.

# BEFORE DRIVING - Combination Switch

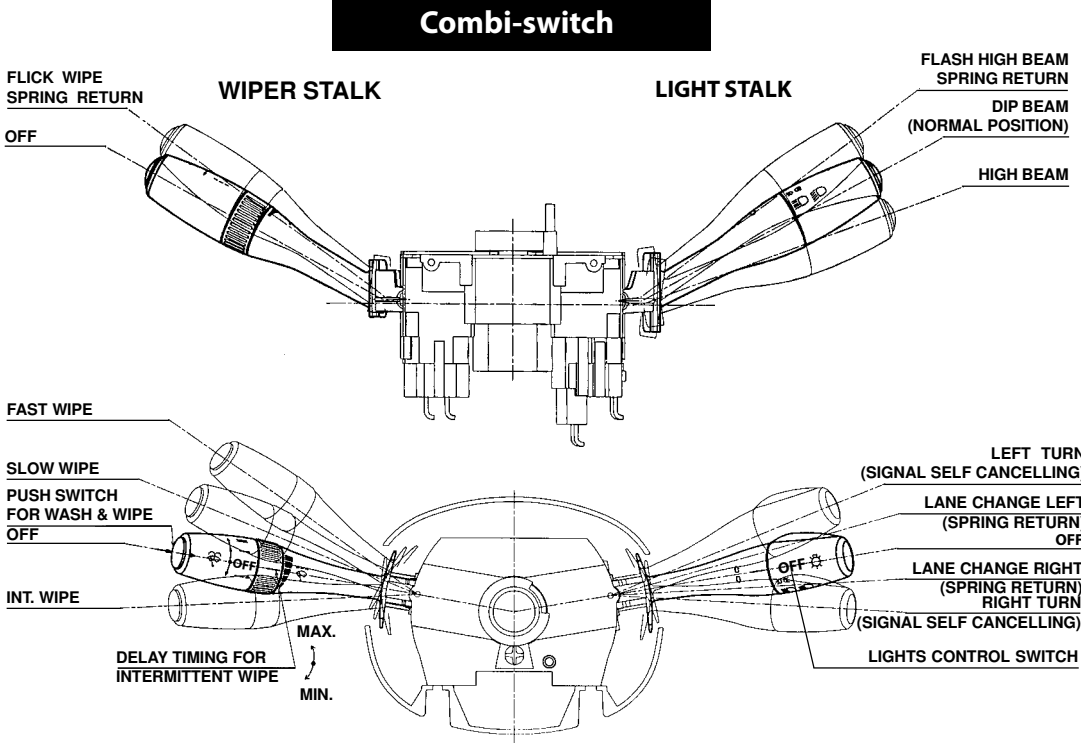

In some version, light stalk is different than that shown in above sketch

## BEFORE DRIVING - Combination Switch

### WIPER CONTROL SWITCH LEVER - LEFT

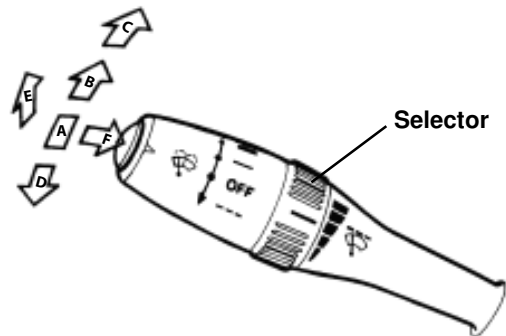

#### Wiper Control Switch Lever - Left

- A. Wiper 'OFF' position
- B. Slow Wipe
- C. Fast Wipe
- D. Intermittent wipe \*
- E. Pull up for windshield wipe  
(Flick Wipe Spring Return)
- F. Press side knob for wash and wipe

\* Rotate selector to set delay timing for intermittent wipe

### LIGHTS CONTROL SWITCH LEVER - RIGHT

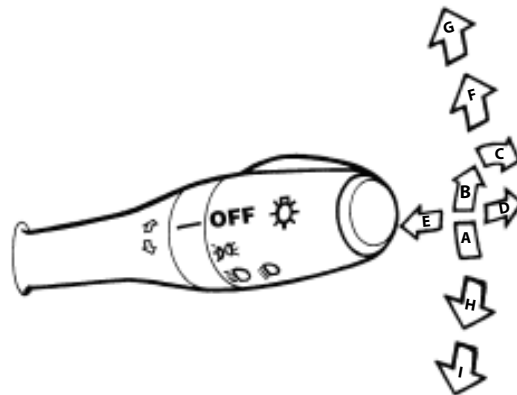

#### Lights Control Switch Lever - Right

- A. Head lamp 'OFF' position
- B. Position lamp 'ON'
- C. Position lamp & head lamp 'ON'
- D. Push down the lever for high beam
- E. Pull up the lever (spring return) for high beam flash
- F. Lane change left (spring return)
- G. Side Indicator - LH (self cancelling)
- H. Lane change right (spring return)
- I. Side Indicator - RH (self cancelling)

### Accessory Switches : (if installed)

Accessory switches have been provided on the dash board near the steering column on the right hand side.

#### 1. Rear windshield demister (unlatched switch)

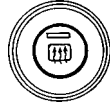

The switch is pushed and released to switch 'ON' and the knob returns to the normal position. The function indicator lights up in amber indicating that the demister heater is 'ON'. The function is controlled through a timer and operates for 15 minutes (approximately) and goes 'OFF' automatically at the end of the duration. The heater can be switched 'OFF' anytime by once again pushing and releasing the switch knob.

**Note :** Switching 'ON' and 'OFF' can be done only with key in 'IGN' position. The demister heater remains 'ON' even after removal of ignition switch key and goes 'OFF' at the end of 15 minutes period.



Accessory Switches

## BEFORE DRIVING - Fog Lamps

---

### Fog lamps : (If fitted)

Front and Rear fog lamps can be switched ON/OFF by rotating the switch on Combi-Switch.

**For front fog lamp:** Rotate the switch clockwise to switch 'ON' the front fog lamp. Front fog lamps are operative only when the position lamps are switched 'ON'. Rotate the switch to same direction to switch 'OFF' the front fog lamp.

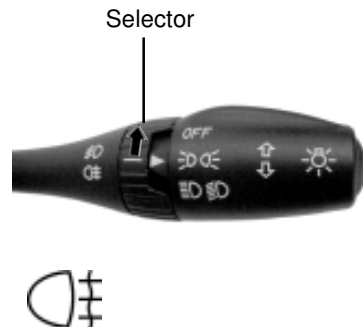

**For rear fog lamp:** Rotate the switch anticlockwise to switch 'ON' rear fog lamp. Rear fog lamps are operative only when the head lights are switched 'ON' or front fog lamps are switched 'ON'. Rotate the switch to same direction to switch 'OFF' the rear fog lamp.

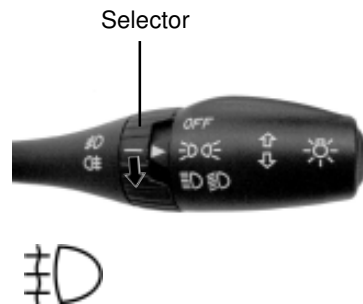



## BEFORE DRIVING - Accessory Switches

### Gearshift lever & Shifting pattern :

The gearshift lever is mounted on the central console between the two front seats. The gearshift pattern is shown on the gear lever knob.

#### NOTICE

The reverse gear should be engaged only when the car is stationary. Wait for 5 seconds after declutching to ensure smooth engagement of the reverse gear.

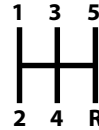

Gear Shifting Lever



### Parking brake :

A mechanical parking brake acting only on the rear wheels is provided on your car. The parking brake lever is located behind the gearshift lever. To apply the parking brake, pull the lever up fully. The indicator light (P) on the instrument panel will become 'ON'. To release it, **pull the lever up slightly**, press the release button and push the lever down. The parking brake indicator (P) on the instrument panel will go 'OFF' when the parking brake lever is fully released.

#### NOTICE

Apply the parking brake properly before leaving the car & release it before moving. Use the parking brake for holding the car on a gradient.

Release Button

Parking Brake Lever

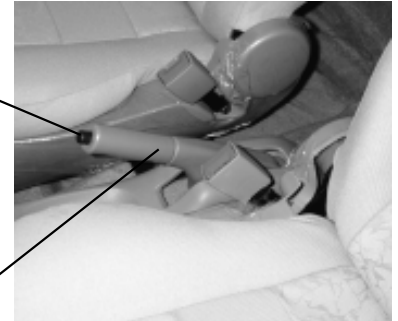

**INSTRUMENT PANEL (DIESEL)**

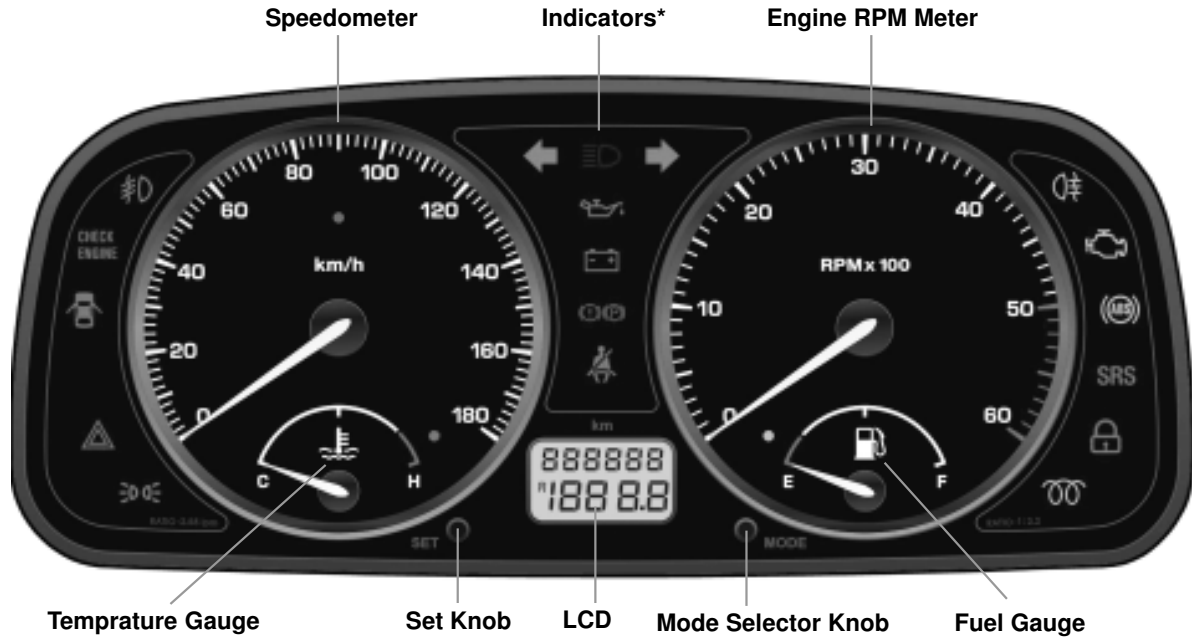

\*All indicators and Chrome ring may not be provided on some clusters.

INSTRUMENT PANEL (PETROL)

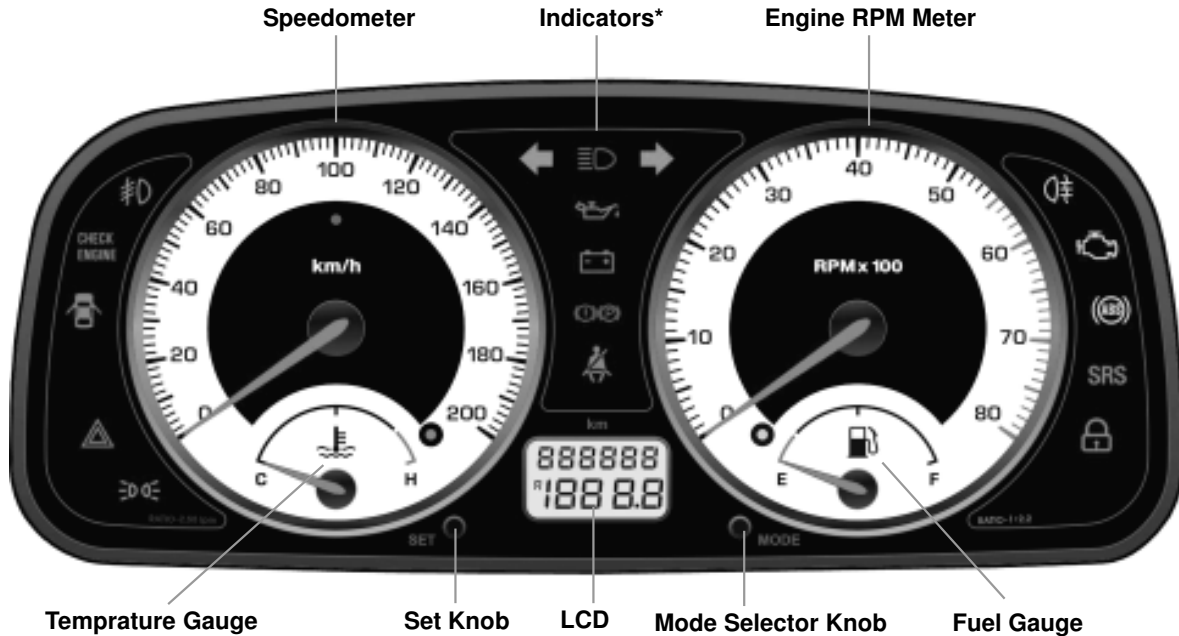

\*All indicators and Chrome ring may not be provided on some clusters.

## BEFORE DRIVING - Turn Signal & Hazard Warning

---

### Turn Signal and Hazard Warning :

#### I) Turn Signal :

Turn signal lamps can be operated only when the ignition supply is 'ON' and by using the turn indicator switch on the combiswitch.

The direction indicator arrow ◀ (LHS) and ▶ (RHS) on the instrument cluster flashes alongwith external indicator lights as selected.

#### II) Hazard Warning :

This can be operated without ignition 'ON'. Press the hazard warning switch (red knob) on the centre of the dash board, all side indicator lights and indicator  if provided on cluster will flash simultaneously to warn the other road users about any hazardous condition of the car. Depress the knob again to switch 'OFF' the hazard function.

#### CAUTION

If lights do not blink or blink rapidly, it is an indication of problem in the blinker electrical system or the indicator bulb at front or rear has fused. Get it rectified immediately.



**Hazard Warning Switch**

### Parking Brake Indicator cum Low Brake Fluid Warning Light

When the ignition key is turned to the 'IGN' position, It comes 'ON' for 3 seconds and goes 'OFF' ( self check). The symbols light up bright contineously for the following conditions :

- i) when the parking brake is applied, and/or
- ii) when the brake fluid level in the container is low with parking brake released and with brake fluid level in the container is normal, the symbol lights up with low intensity to indicate the warning to check for the lamp bulb. The lamp in this condition goes off automatically along with battery charge indicator when the engine is started. If the lamp glows bright while engine is running, then check the parking brake or brake fluid oil level.

#### CAUTION

Do not drive the car if this indicator remains 'ON'. Get the problem attended to immediately at an Authorised Service outlet.

### High Beam Indicator :

Symbol lights up when the headlamp high beam is 'ON'.



## BEFORE DRIVING - Indicators

---

### Position Lamp Indicator :

Symbol lights up when the position lamps are switched 'ON'. (Instrument cluster illumination lamps, illumination lamps for AC, HVAC or ventilation panel are 'ON', when the position lamps are 'ON'). The intensity of digital clock display reduces. Position lamps can be used as parking lamps.



#### NOTICE

Position lamps also remain 'ON' while head lamps are 'ON' and in this condition, instrument cluster illumination lamps will not be 'ON'.

### Low Oil Pressure Indicator :

When the ignition key is turned to the 'IGN' position, symbol lights up and goes off as soon as the required engine oil pressure is developed after starting the engine.



#### NOTICE

If the low oil pressure indicator does not glow or remains 'ON' with the 'IGN' on and engine is running, it indicates a fault in the electrical circuit/lubrication system. Check & get the problem attended to at an Authorised Service outlet.

### Water in fuel sedimenter indicator lamp:(If fitted)- Common Rail

This light comes 'ON' when there is excess water in the Water sedimenter. In the event of this lamp glowing continuously, it is recommended to take your vehicle to nearest service outlet or drain the water from the sedimenter yourself. Please refer to fuel filter and fuel system in maintenance section for steps to be followed for draining the Water.



### Battery Charging Indicator :

Symbol lights up when the 'IGN' is turned 'ON' and should go 'OFF' after the engine starts.



#### NOTICE

If it remains 'ON' while the engine is running, it indicates that the battery is not being charged. Switch off all unnecessary electrical equipment and get the problem attended to at an Authorised Service outlet.

## BEFORE DRIVING - Indicators

---

### Glow Plug Indicator

Symbol lights up when the 'IGN' is switched 'ON' and goes off after a few moments automatically depending on the engine temperature, indicating readiness to start the engine.

**Do not start the engine until this light goes off.** The duration of 'ON' time varies with engine block temperature and it glows for a longer duration with a cold engine.



### NOTICE

If this indicator blinks instead of glowing steadily, it indicates that the temperature sensor connection to the glow plug regulator is either open or the sensor is faulty. In this condition, the engine can be started, and the car can be driven. However, the fault should be attended to at the earliest, at an Authorised Service outlet, as it affects the engine starting performance initially before the engine warms up.

### 'Check Engine' Indicator (BS-III)

This lamp indicates engine condition, when a malfunctioning occurs in Engine or EMS, this lamp indicates as below:

1. Remains 'OFF' in 'IGN' position. **OR**
2. Remains 'ON' in running position.

**CHECK  
ENGINE**



### Malfunction Indicator : (BS- IV)

This lamp indicates the engine condition. When a malfunction occurs in Engine or Engine Management System (EMS), this lamp will glow when the engine is running to indicate the fault.

#### NOTICE

When the IGN is turned on this lamp will glow for a few seconds and go off, this is normal and indicates that the lamp is OK.

### Headlamp leveling switch: (If fitted)

A motorised headlamp leveling arrangement with the setting knob at the dash board is provided on the LH side of steering column.

As and when required, head lamp leveling, setting is done by rotating the knob to select one of the 3 levels marked in the switch depending upon the loading of the vehicle.

Head lamp leveling can be done with the head lamp in Low beam and in ON position.

#### NOTICE

- Setting should be done only when the car is stationary.
- Since the leveling switch alters the headlamp focus pattern under varying load conditions, it is advisable to select the correct position before starting a trip depending on load.

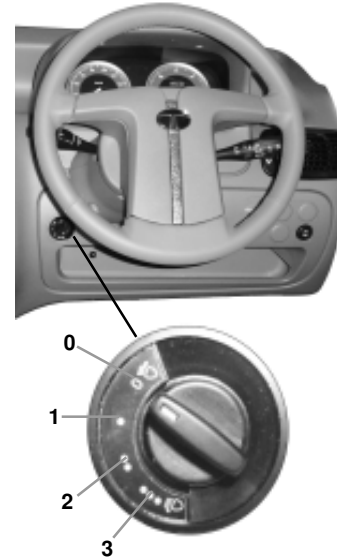

## BEFORE DRIVING - Gauges

### Speedometer, Odometer and Tripmeter (on LCD) :

The speedometer indicates the car speed in km/hr. The odometer records the total distance the car has been driven. The tripmeter can be used to measure the distance travelled on each trip or between fuel fillings. The tripmeter can be reset to zero by pushing the reset knob.

#### NOTICE

Keep track of the odometer reading and follow the maintenance schedule regularly for meeting service requirements.

### Odometer, Tripmeter and Illumination insetnessity control on instrument panel (LCD) :

The Instrument panel has a LCD to display the following

- Main Odometer (Non-resettable) - Counts upto 999999 kms
- Tripmeter A (Resettable) - Counts upto 1999.9 kms
- Tripmeter B (Resettable) - Counts upto 1999.9 kms

**Intensity level of instrument panel illumination** - selection among preset levels.

LCD has two line display. The first line displays the Odometer count. The second line displays either of Tripmeter A, Trip meter B, Intensity level of panel illumination.

The selection and control of functions are done through 'MODE' and 'SET' pushbuttons (knobs) provided on either side of the LCD.



Speedometer - Diesel



Speedometer - Petrol

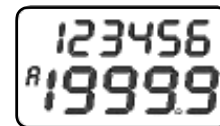

Display for Trip - A

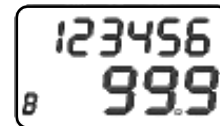

Display for Trip - B

Odometer

Tripmeter  
or  
Intensity  
level of  
panel  
illumination

Set  
Knob

Mode  
Selector  
Knob

The 'MODE' knob is used to select one of Tripmeter A, Tripmeter B or Intensity level of panel illumination. Switching among the above three function can be done by pressing the knob.

### RPM meter : (if installed)

The meter indicates engine speed in revolutions per minute (rpm). Change gears at appropriate engine rpm and car speed to get optimum fuel economy.

The red mark provided on the dial is the permitted engine rpm upper limit. (5000 RPM for Diesel vehicles)

If RPM meter doesnot indicate during cold starting, gently raise the engine RPM till the battery charge lamp goes off.

### Temperature gauge :

The gauge indicates the temperature level of the engine coolant. The red zone at 'H' indicates temperatures higher than normal.

Avoid driving, when the pointer is in the red zone. It indicates engine overheating, which may be due to insufficient coolant in the radiator or due to any other defect. Take the car to the nearest Authorised Service outlet for necessary attention.

### CAUTION

Never remove the cap from the coolant reservoir when the engine is hot. Do not restart the engine until the problem has been duly attended.

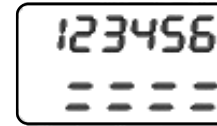

Intensity Level Indicator



RPM Meter - Diesel



RPM Meter - Petrol



High Temperature Warning

Temperature Gauge - Diesel



High Temperature Warning

Temperature Gauge - Petrol

## BEFORE DRIVING -Gauges / Audio Warning

### Fuel Gauge :

The fuel gauge indicates the approximate fuel level in the tank. Refill the fuel tank at the earliest, when the needle touches the red band at this time amber light comes 'ON' (indicating reserve level has been reached.) When key is turned to 'IGN' amber light will come 'ON' and go 'OFF' as a self-check, even if needle not touches the red band.

### NOTICE

As the gauge is a high damped type, observe the reading only 60 seconds after the ignition being 'ON'.

### Over speed warning indicator: ( if provided)

The over speed warning indicator will come 'ON' if vehicle speed is reaching more than 120 kmph.

### Audio Warning Unit

#### Seat-belt Reminder (Beeper) : (If installed)

When the key is in the 'IGN' position and the driver's seat-belt has not been fastened, you get an audio warning. The beeper will go off automatically after a few seconds.

#### 'Key in 'Warning Beeper' : (if installed)

When the ignition is turned to 'OFF' position and the key is not removed from the switch, an audio beep comes on if driver door is open. The beeper will go off after a few seconds automatically or if warning is ignored or if the key is removed/door is closed.



Low Fuel Warning

Fuel Gauge - Diesel



Low Fuel Warning

Fuel Gauge - Petrol

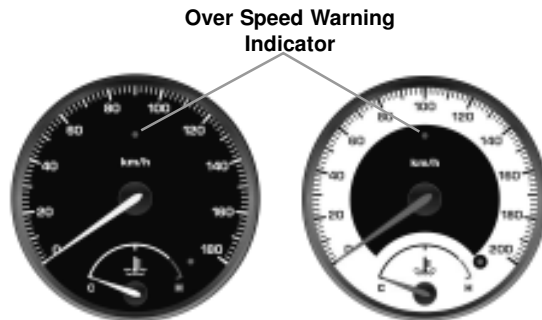

Speedometer - Diesel

Speedometer - Petrol

## BEFORE DRIVING - Audio Warning & Tail Lamp

### Lamps 'ON' Reminder (if installed)

When the lamps are 'ON', with the ignition key removed from the switch and driver's door is opened then an audio warning is heard to remind you that the lamps are left 'ON'. Please switch off the lamps before leaving the car. However the lamps can be kept 'ON' despite the warning, if desired.

**Tail Lamp :** The tail lamp assembly incorporates the following-

1. Stop / Brake Light
2. Indicator Lamp
3. Reverse Lamp
4. Reflex Reflector
5. Position Lamp
6. Fog Lamp

### Registration Plate Lamps :

Two concealed lamps are provided for illumination of the rear registration number plate.

### High Mounted Stop Lamp :

High mounted stop lamp is provided at the rear and it glows whenever service brake is applied.

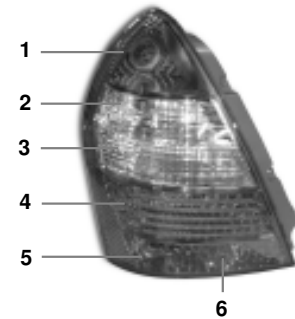

**High mounted  
stop lamp**

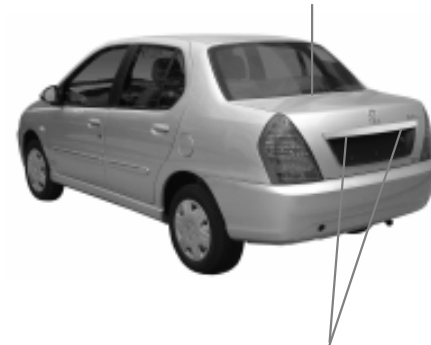

**Registration Plate Lamps**

## Air Flow Pattern

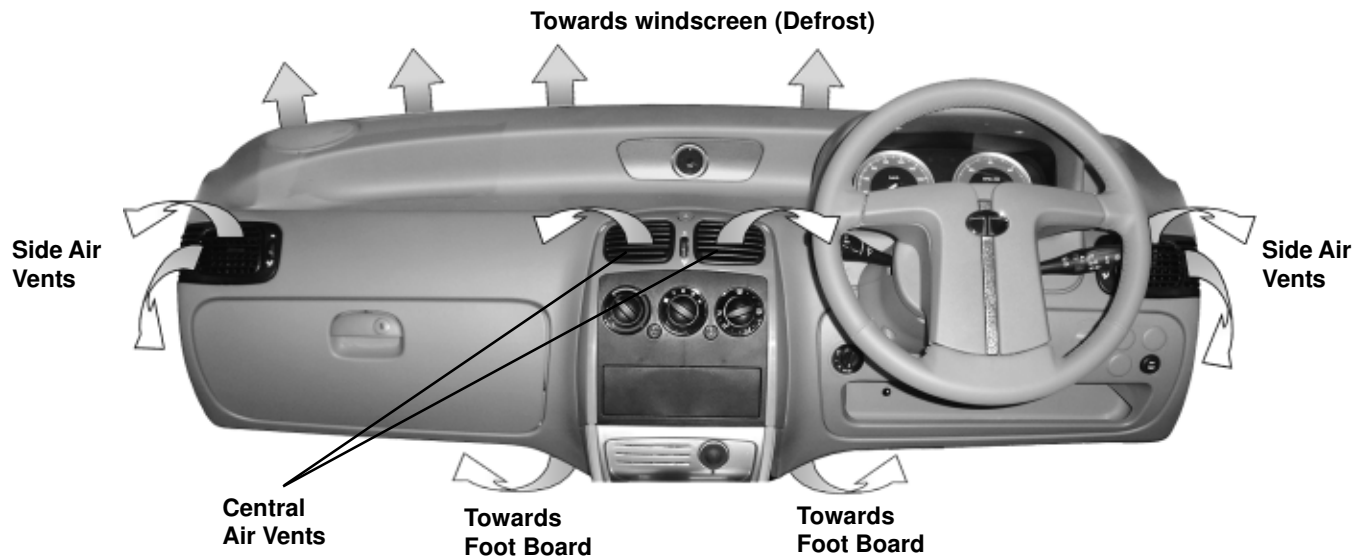

## BEFORE DRIVING - Heating, Ventilation & Air-Conditioning

### HEATING, VENTILATION & AIR CONDITIONING

(if installed)

#### A. Temperature Control Knob :

The air temperature in the car can be controlled by operating the temperature control knob **(A)** at the left hand side of the control panel. The temperature can be increased by rotating the knob towards the red segment and decreased by rotating it towards the blue segment.

#### B. Blower Speed Regulation Knob :

The ventilation system has a three/four speed blower. The blower speeds can be regulated to any one of the following speeds by operating the knob **(B)** at the centre of the control panel.

**LOW • MEDIUM • HIGH • VERY HIGH**

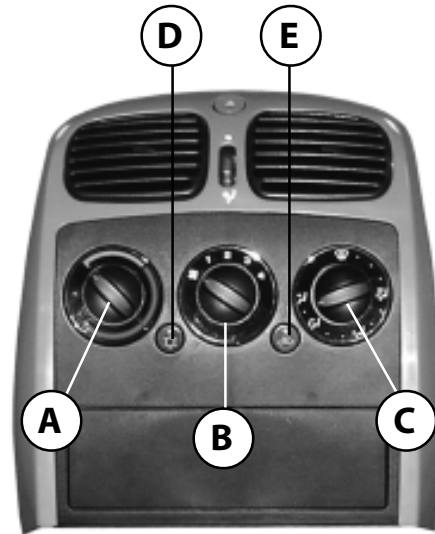

H.V.A.C. CONTROLS

## BEFORE DRIVING -Heating, Ventilation & Air-Conditioning

---

### C. Air Direction Control Knob :

The air flow can be changed by turning the switch (C) to the desired direction.

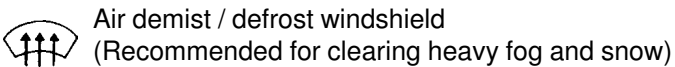
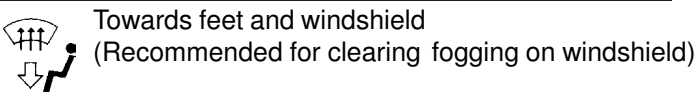
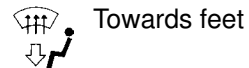
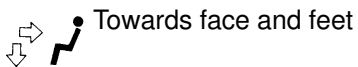
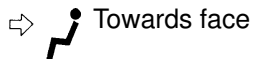

### D. A.C. ON/OFF Switch :

The A.C. can be switched 'ON' by pressing the switch (D) on the A.C. control panel provided the blower is 'ON' and the engine is running. The indicator lamp will show that the A.C. is 'ON'.

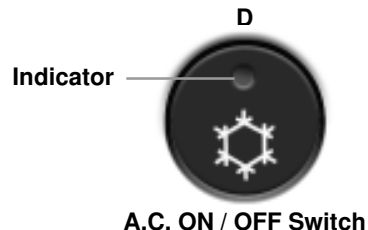



## BEFORE DRIVING - Heating, Ventilation & Air-Conditioning

### E. Air Circulation Switch :

- In HVAC version to put air circulation mode in recirculation, press switch 'E'. The indicator lamp will show air circulation is in recirculation.  
To put vehicle in Fresh mode release switch 'E'. Indicator lamp will be 'OFF'.
- In A.C. version, air circulation mode can be selected by pressing knob 'E'.
- In recirculation mode, air inside the vehicle is circulated again and again. In Fresh mode, air is taken from atmosphere and circulated in the vehicle.  
Recirculation mode can be used
  - While driving in dusty condition
  - To avoid traffic pollution
  - To get quick cooling/heating as required.

Whenever discomfort is felt switch air circulation mode to fresh.

#### NOTICE

The A.C. can be switched 'ON' only if the blower is 'ON' and engine is running. When A.C. is switched 'ON' engine idling RPM increases marginally, to adjust to the A.C. compressor load. When desired temperature is achieved A.C. trips 'OFF' automatically.

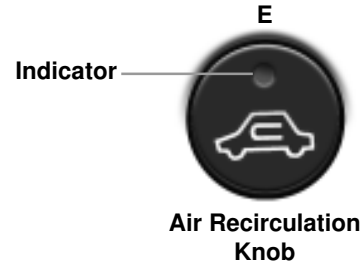

#### NOTICE

The A.C. compressor gets switched 'OFF' automatically when engine gets overheated. The A.C. is automatically switched 'ON' when the engine cools down.

#### Normal Cooling :

A.C. - ON

Knob 'B' - Desired speed position

Knob 'C' - Towards face → 

Switch 'E' - Suitably as explained

#### Quick Cooling :

If your car is left in the sun with window closed, inside temperature increases.

## BEFORE DRIVING -Heating, Ventilation & Air-Conditioning

---

To achieve quick cooling effect, open the windows briefly while you operate the air conditioner, with air circulation switch is in Fresh mode, fan at higher speed and air direction towards 'FACE'. All vents to be opened completely. Once temperature inside has come down sufficiently, close the windows and change air circulation suitably to fresh/recirculation.

### Demisting :

In rainy season or in areas of high humidity, mist formation inside windshield glass is observed. To clear mist dehumidified air is passed on the windshield glass.

**The position of control knobs should be adjusted as follows :**

A.C. - ON

Knob 'B' - desired speed position

Knob 'C' - Towards windshield

Knob 'A' (Vehicles fitted with HVAC)- at suitable temperature

Air circulation - at suitable position

### NOTICE

When mist gets cleared switch the knob "C" position to Face mode. In high humidity areas, if cold air continues to flow over windshield, it may cause sudden fogging on outside surface of windshield.

### Defrosting :(For vehicles fitted with HVAC unit)

In low temperature areas, to clear frost formation outside the windshield glass, this setting is used.

First start the engine and accelerate to warm up.

Knob 'A' - Maximum hot position

Knob 'B' - Very High

Knob 'C' - Towards windshield

Switch 'E' - Fresh air mode condition

Once the windscreen has become clear, move the fan switch to desired speed.

### NOTICE

Electric heater coil is provided for demisting of tail gate glass for deluxe versions.

### Normal Heating :( For vehicles fitted with HVAC )

Knob 'A' - Suitable temperature position

Knob 'B' - Suitable blower speed

Knob 'C' - Towards face & feet

A.C. - OFF

Air Circulation- Fresh switch

## BEFORE DRIVING - Heating, Ventilation & Air-Conditioning

### Quick Heating :

All settings as explained before except air circulation switch to recirculation.

Once vehicle is heated, switch back to fresh mode.

### Ventilator :

The air flow can be adjusted continuously with the rotary control knob at the vents on the dash board. The air vents can be adjusted upward and downward. This is common for HVAC, AC and ventilation.

#### NOTICE

Refrigerant charged in the air conditioning circuit has been identified on the label over front body member. Use only refrigerant as given in the label for topping up or recharge, i.e. do not charge R12 (CFC) in the vehicle earlier charged with R134a (Non CFC) or vice versa.

#### NOTICE

Fresh air is taken from the grill opening provided at base of windshield glass outside the vehicle. Keep these openings clear and free from fallen leaves etc.

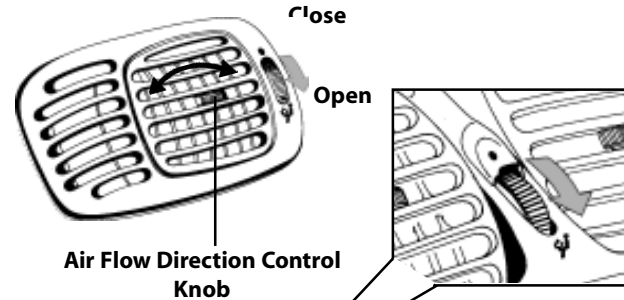

## BEFORE DRIVING -Interiors & Accessories

---

### REAR VIEW MIRRORS

**Door mirrors :** Driver side only (In Standard model)

Both sides (In Deluxe model)

The rear view mirror is fitted on the door from the outside and can be adjusted by the lever provided inside the door.



### Motorised rear view mirrors : (if fitted)

Motorised Rear View Mirrors are fitted on both front doors and can be adjusted to the desired position with the help of a switch provided on the dashboard. This switch allow the driver to adjust the mirrors without lowering the glasses and without moving from his position.

1. Move the main switch to L (for left side) and R (for right side)
2. Use the 4 positions of the knob (marked by triangle) to adjust the rear view mirrors to correct angles.

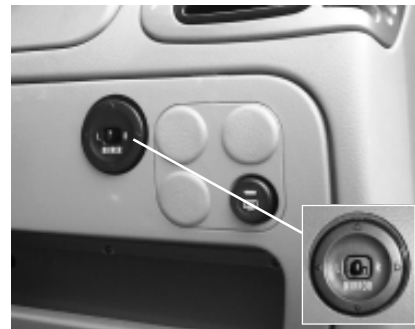

**Rear view mirror  
adjustment switch**

### Inner Rear View Mirror :

Antiglare mirror has been fitted inside the cab. Provision has been made for two positions :

1. Normal position
2. Antiglare position

Use antiglare position only when necessary, as it reduces rear view clarity.

### Goggle Case :

A goggle case is provided near inner rear view mirror for keeping the goggles. Pull the cover to open, place the goggle (keeping glass facing towards antidust cloth) and press to lock.

### Sunvisors :

Two adjustable sunvisors are provided inside the cab above the windshield to prevent sun glare.

Lower the sunvisors to protect the eyes from bright sunlight. The sunvisor also moves sideways towards the door.

A vanity mirror has been provided on the back of the co-driver's sunvisor.

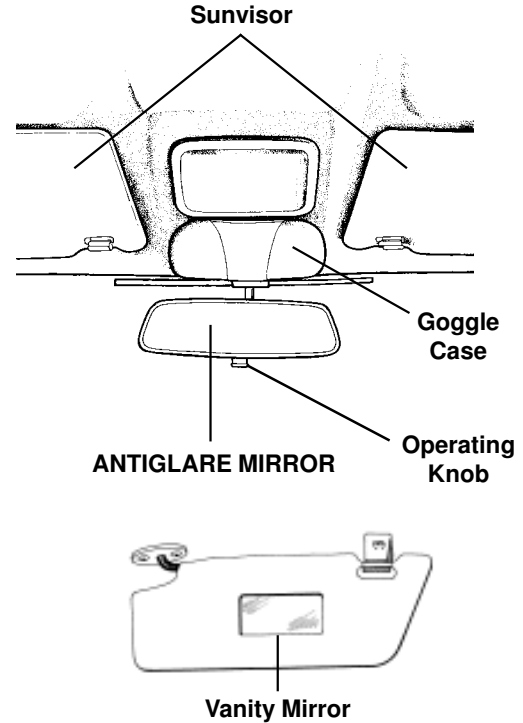

### CAUTION

When not in use keep the sunvisors in their original position otherwise they may block the driver's vision.

## BEFORE DRIVING -Interiors & Accessories

### Reflex Reflectors :

For LX version reflex reflectors are provided on the inner side of the front and rear doors to warn the traffic coming from the rear that the door is open.

### Glove Box :

The glove box is located on the dash board in front of the co-driver's seat. The glove box can be locked with the ignition key.

Cup holders are provided on the inner face of glove box flap.

### CAUTION

Do not use the cup holders while the car is in motion.



Reflex Reflector

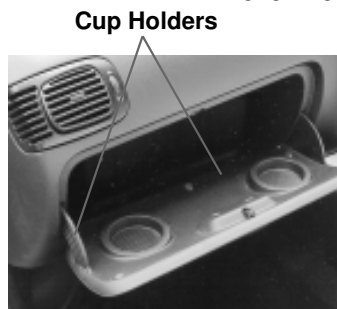

Cup Holders

### Window Winding :

#### Manually Operated Window Winding :

Window winding in the standard version is manually operated. Rotate the handle on the door pad to raise or lower the window glass.

#### Power Windows : (if installed)

All the window glasses can be operated by means of switches, provided on the central console near the gear shift lever for all the four windows. These can be operated only when the key is in the 'IGN' position.

Pull up the switch to raise the glass.

Press down the switch to lower the glass

In the same switch, a safety locking arrangement has also been provided by means of a push type switch. This switch has two positions:

**LOCK** - When the key is in depressed position.

**UNLOCK** – When the switch is in normal position.

In the 'LOCK' position, the rear window switches become inoperative. However the rear windows can be operated by the switches on the console. Illumination on rear window switches goes off in locked position. Press down the lock button to unlock. Individual window winding switches have been provided only on the rear doors.

### WARNING

While raising the glass take care to avoid fingers/hands getting trapped between the glass and the frame.

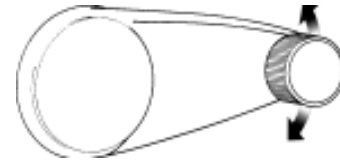

Window Winding Lever



Window Winding Switch



Window Winding Switch On Rear Door

## BEFORE DRIVING -Interiors & Accessories

---

### Ashtray :

Ashtrays are provided on both rear doors for the occupants at the rear. (Only on Deluxe version)

To open the rear ash tray press the lid, it will rotate outward.

#### CAUTION

Do not forget to extinguish the cigarette butts, before putting them in the ashtray.

Do not put paper or other flammable material in the ashtrays.

To remove the ashtray, open it fully and press down to disengage the top pivot pin.

To refit the ashtray, locate the bottom pivot and push the top pivot pin to place.

### Analog Clock : (if fitted)

This Vehicle is fitted with analog clock and powered by electrical system. It has knob at the bottom of dial for resetting time.



**Ashtray on rear door**



**Analog Clock**



### Digital Clock : ( if installed )

A digital clock is provided in the middle of the dash board. It displays the time when the steering lock cum ignition switch is in 'IGN' position.

Three push knobs 'H', 'M' and 'Z' are provided for setting the time and for resetting the display to zero - 'H' for hours setting, 'M' for minute setting and 'Z' for accurate setting of the clock.

### Roof Lamps :

Front interior light with reading lamps :

Interior roof lighting and reading lamps with inbuilt switches are provided on the roof near the rear view mirror.

The central rectangular switch has three positions :

- **ON** - The lamp will come 'ON' as long as switch is in this position.

 **DOOR** - In this position the lamp comes on when either of the front doors are opened. When the door is closed, the lamp will not go 'OFF' immediately, but remain 'ON' for 5-8 sec. This helps you to settle in your seat and also insert the key into the Ignition switch.

When the key is turned to the 'IGN' position, the lamp goes 'OFF' immediately, before the delay period.

- **OFF** - In this position the lamp will remain 'OFF' in all conditions.



H M Z

Front Reading Lamps

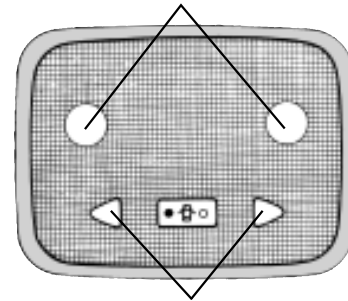

Push Button

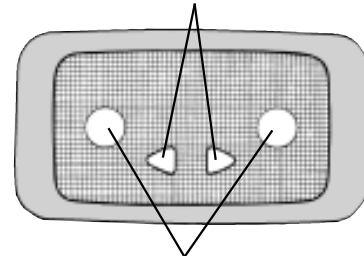

Rear Reading Lamps

## BEFORE DRIVING -Interiors & Accessories

---

Two triangular shaped push type 'ON / OFF' switches are provided separately for the right and left reading lamps.

### Rear reading lamps :

A roof mounted lamp with two reading lamps is provided above the rear seat.

Two triangular shaped push type 'ON / OFF' switches are provided separately for the right and left reading lamps.

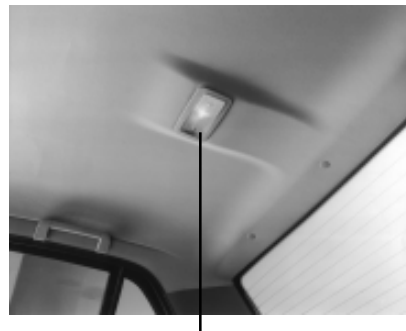

**Rear Reading Lamp**

### Luggage Compartment Lamp :

A lamp is fitted in the luggage compartment centrally below the parcel shelf to illuminate the luggage area, ON/OFF switch is provided on the lamp and it should be in 'ON' position for lamp to come on automatically with the opening of the trunk lid.

This control is through a switch provided underneath the LH hinge of the trunk lid.

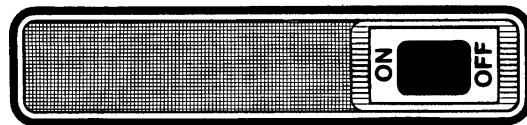

**Luggage Compartment Lamp**

### Front Seats and Seat Adjustments :

Front Seats : Both the driver and co-driver seats are of bucket type to provide maximum riding comfort.

### Moving the seats forward and backward :

To adjust the seat position, lift the lever (1) under the seat cushion front, then move the seat to the desired position and release the lever.

Make sure the seat is locked in position.

### Adjusting the angle of the seat back :

To adjust the angle of the seat back, a lever (3) has been provided on the sides of the front seats. By lifting the lever, you can adjust the angle of the backrest.

#### **⚠ CAUTION**

Do not adjust the seat when the car is in motion.

Always adjust the seat back to an upright position and sit well back in the seat.

### Seat height adjustment lever: (if provided)

Front Seats height can be adjusted for better drivability. The knob (2) provided on the side of the seats has to be manually opened as per need.



1. Lever for seat backward/forward movement
2. Lever for seat height adjustment
3. Lever for seat back angle adjustment

## BEFORE DRIVING -Interiors & Accessories

---

**Head-rest :** (Adjustable on the front seat & fixed on the rear seat)

Head-rests are designed to help reduce the risk of neck injuries in case of accidents. For best protection, adjust the top of the headrest, so that it is in level with one's ears. To adjust the headrest pull /push it to the desired position until it clicks. The headrest can be adjusted up to 64 mm in steps of 16 mm. If headrest is required to be removed (for cleaning fabric etc.) pull the headrest fully up, then push notch button with a thin punch while pulling the headrest up. To install follow the reverse order of removal.

***Avoid driving the car with the head-rest removed as it is a safety item. Do not attempt to adjust the head-rest while driving the car.***

**Rear Seat :**

A cushion bench seat has been provided for the rear passengers. The seat back can be folded forward by releasing the latch, on both the 'C' pillars simultaneously. For making more luggage space, the folded rear seat can be somersaulted further. Before somersaulting ensure that the front seats are at 3/4 the full travel towards rear.

For fixing the seat back upright, just push back the seat in position. It will get locked by itself.

**Foldable arm rest for rear assengers : (if provided)**

A Foldable arm rest is provided in the centre of the rear seat. Pull out the armrest when needed and fold back to it's original position, otherwise.

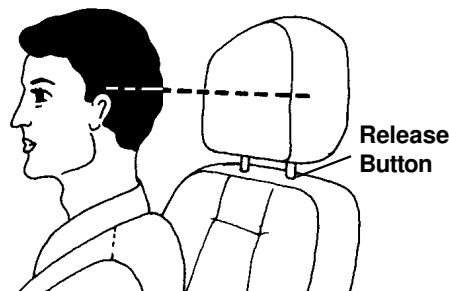

**Foldable Arm Rest for Rear Passengers**

### Seat-Belt :

Seat-belts have been provided on the front and rear seats (with micro switch on driver's side for the deluxe model)

#### WARNING

Always wear seat belts, while driving.

### Seat-belt adjustment :

1. Pull the latch plate across your body and insert it into the buckle.
2. Check and ensure that the belt is not twisted.
3. Position the lap portion of the belt as low as possible across your hip bone.
4. Pull up the shoulder part of the belt to remove the slack.
5. Make sure that the belt goes over your collar bone and across the chest.
6. Belt gets locked automatically in case of sudden deceleration or roll.
7. To unlatch the belt, press the red button on the buckle. Guide the belt to the pillar as it retracts.

#### WARNING

Do not wear your seat-belt over hard or breakable objects in pockets or on your clothing. If an accident occurs, objects such as glasses, pens, etc. under the seat-belt can cause injury.

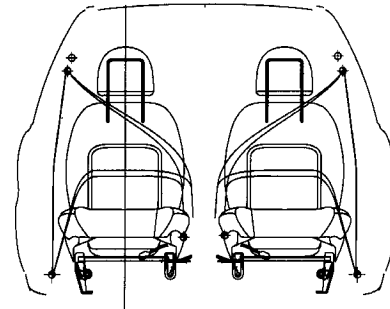

Front seat seat-belts arrangement

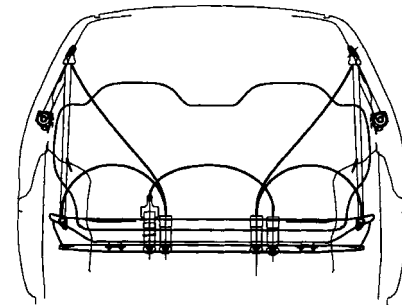

Rear seat seat-belts arrangement  
viewed from rear

## BEFORE DRIVING -Interiors & Accessories

---

### Provision of Music System :

A provision has been made for fitting of music system.

An internal antenna comes fitted on the front windshield glass on the inner side near the rear view mirror. Provision for the installation of speakers is made on the dash board on both the sides and on each of the front doors and on parcel tray.

In few version a multimedia system is provided

( for details please refer page no. 52 B)

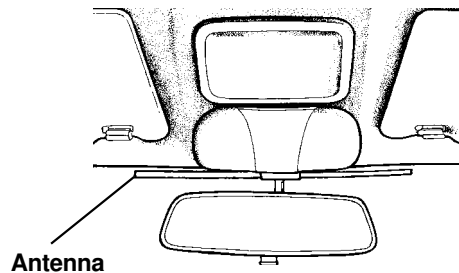

### Power Socket :

A power socket is provided on the central console below AC control knobs. This can be used for connecting loads upto 10 A maximum like mobile charger. To use this socket , remove the cap first.

Always keep this socket covered with the cap when not in use.



Power Socket

### Trunk Lid opening :

A trunk lid opening lever is provided on the floor between the driver's seat and door.

Pull the lever up to unlock the trunk lid.

Lift the trunk lid by hand using the recess in the centre, near the bumper. The two telescopic balancers will open the door automatically.

To close and lock the trunk lid push it down.

The trunk lid can also be opened with the key.

### Fuel flap opening :

The fuel flap is located on the left rear side of the car. The fuel flap can be opened by pulling the opening lever located near the trunk lid opening lever and can be locked by simply closing the flap.

#### WARNING

Fuel vapour is extremely hazardous. Always stop the engine before refueling and never fuel near sparks or open flames.

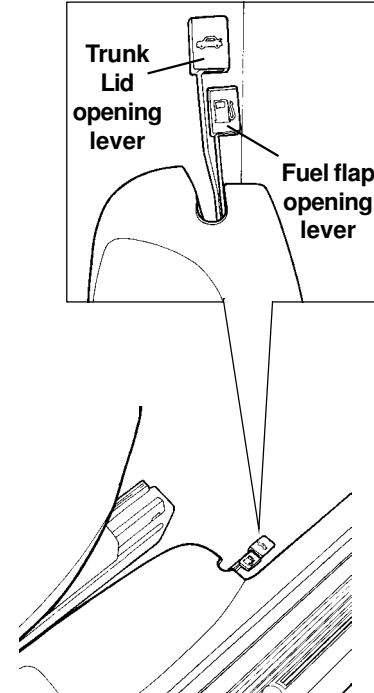

## BEFORE DRIVING -Interiors & Accessories

---

### Side Utility Pocket :

Additional side utility pockets are provided in luggage area to keep small items. One side utility pocket is provided with net for more flexibility.

#### NOTICE

Do not keep heavy/sharp items in the side utility pocket.

### Tool Kit :

A tool kit is provided with your car and is located on the left side of the luggage area

#### NOTICE

The tool kit should be properly secured after usage.

### Jack :

The jack is provided with your car and is located in the luggage area. The handle jack is provided in the tool kit.

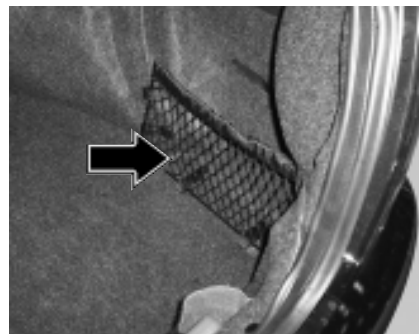

**Side Utility Pocket**

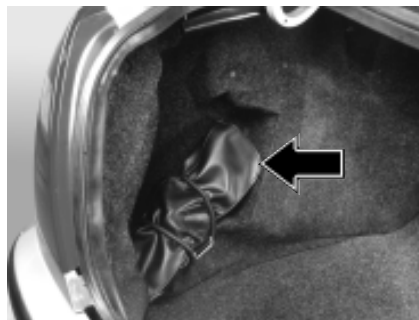

**Location of Toolkit & Jack**



# STARTING AND DRIVING THE CAR

---

## ■ STARTING & DRIVING

- Opening & Closing the Bonnet
- Check List
- Fuel Level
- Engine Oil Level
- Engine Coolant Level
- Brake Fluid Level

## ■ STARTING & STOPPING

- Starting the Engine
- Stopping the Engine

## ■ PREPARING TO DRIVE

- Preparing to drive
- Running in Instructions
- Gear Shifting

## ■ FUEL ECONOMY

- Instructions to Improve Fuel Economy

## ■ DRIVING IN ADVERSE CONDITIONS

- Driving through Water
- Driving on a Rainy Day
- Night Driving
- Towing the Vehicle

## ■ DRIVING SAFETY

## ■ CAR SAFETY CHECKS

# STARTING & DRIVING -Opening & Closing the bonnet

## OPENING & CLOSING THE BONNET

### Opening :

1. Ensure that the car is in neutral gear with the parking brake applied.
2. Pull the bonnet release lever located under the right hand corner of the dash board. The bonnet will pop up slightly.
3. Raise the bonnet slightly and with your finger lift the secondary lock lever located under the bonnet centre.
4. Lift the bonnet up. Pull the bonnet stay rod from its clip and insert the free end into the slot in the bonnet, slide stay rod outward to secure.

### Closing :

1. To close the bonnet disengage the stay rod & clamp it properly.
2. Lower the bonnet and drop it from a short height to shut.

#### CAUTION

Ensure that the bonnet is properly locked before driving.  
Do not press the bonnet onto the bonnet lock.

#### CAUTION

Do not leave the engine running in a closed garage.

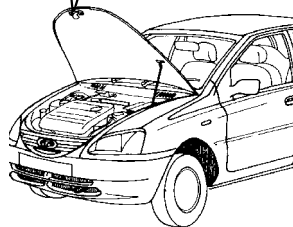
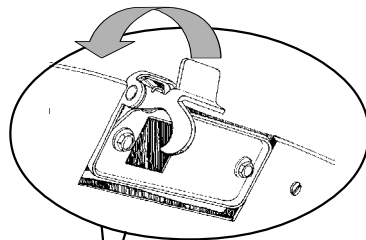
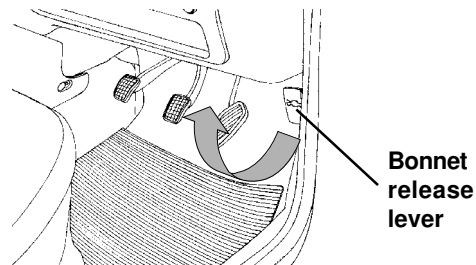

## STARTING & DRIVING - Check List

CHECK	ADJUST	ENSURE
<ol style="list-style-type: none"><li>1. Tyre pressure</li><li>2. Coolant level</li><li>3. Engine oil level</li><li>4. Brake fluid level</li><li>5. Water in windshield washer reservoir</li><li>6. Power steering oil level (if installed)</li><li>7. Battery electrolyte level</li><li>8. Fuel level</li></ol>	<ol style="list-style-type: none"><li>1. Front seat</li><li>2. Rear view mirrors</li></ol>	<ol style="list-style-type: none"><li>1. Bonnet is fully closed</li><li>2. All doors are properly closed</li><li>3. Seat belts are fastened</li><li>4. All switches &amp; lamps are working</li><li>5. Gear shift lever is in neutral position</li><li>6. Parking brake is released</li></ol>

## STARTING & DRIVING - Fuel Level & Engine Oil Level

---

### Fuel Level :

Check fuel level on the gauge in the instrument panel. If the pointer is in the red zone and/or visual low fuel warning indicator glows, please ensure fuel filling at the earliest. Avoid driving with fuel at minimum level.

### Engine Oil Level :

1. Open the bonnet. Pull out the dipstick and wipe it with a clean cloth or a paper napkin.
2. Insert it again to its original position.
3. Pull out the dipstick again and observe the oil level on the dipstick.
4. Top up oil if the oil level is below the mid point of min. and max. marks.

#### NOTICE

Oil level should not exceed the max. mark. Always check the oil level when the car is on level ground and the engine is cold.

Check the engine oil level if low oil pressure warning comes 'ON' while driving.



Low Fuel Warning

Fuel Gauge - Diesel



Low Fuel Warning

Fuel Gauge - Petrol

## STARTING & DRIVING - Engine Coolant & Brake Fluid Level

### Engine Coolant Level :

The coolant level is visible through the translucent reservoir. It should be between max. & min. marks. If it seems less, add premixed coolant into the auxiliary tank upto the max. mark. Put the cap back properly.

#### CAUTION

Never remove the filler cap when the engine is hot. Use only branded premixed ready to use coolant.

In case of an emergency, normal water can be used, but the system should be flushed & filled with proper coolant mixture at the earliest.

### Brake Fluid Level :

The level of the brake fluid must be between the min. & max. marks on the side of the brake fluid container. If the level falls below the min. mark, add recommended brake fluid. **(Refer chapter - Fuels, coolants & lubricants) In case of spongy or hard pedal or low brake efficiency, please contact the nearest Authorised Service outlet.**

#### CAUTION

1. Do not allow brake fluid to make contact with the skin or eyes.
2. Do not allow brake fluid to splash or spill on the paint surface as it will damage the paint. In case of spillage, wipe it off immediately.

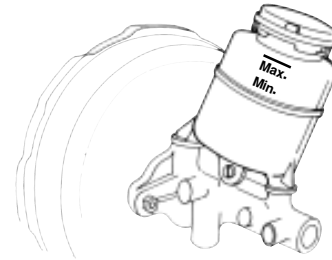
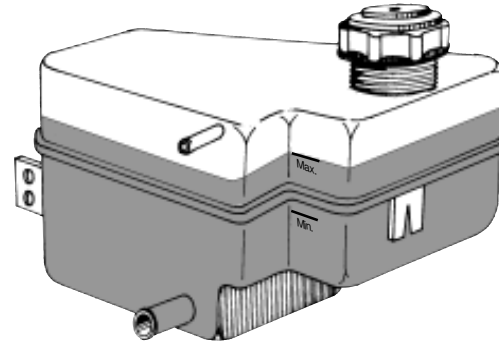

# STARTING & DRIVING - Starting & Stopping

## STARTING THE ENGINE

### Before starting the engine :

- Apply the parking brake fully.
- Ensure that the gear lever is in neutral position.

### Starting the engine (Diesel)

- Press the clutch pedal fully and turn the ignition key to 'IGN' position. Ensure the “**CHECH ENGINE**” (BS-III)“**MIL**” (BS-IV) lamp turns “ON”.

#### NOTICE

The Starter Protection System fitted in this car does not allow you to crank the engine until you fully press the clutch pedal.

- **The glow plug indicator on the instrument panel will glow.**
- **Wait till the glow plug indicator goes off.**
- Do not press the accelerator pedal.
- Keep the clutch pedal fully pressed and crank the engine, if the engine cranks but fails to start then repeat the above procedure. Release the key as soon as the engine starts. Ensure that the “MIL” lamp is “OFF”.
- **After starting the engine, keep the engine in idling for at least 30 seconds. Do not accelerate the engine**

**immediately after starting to avoid damage to turbocharger. (Diesel)**

#### NOTICE

The Starter Protection System switches off the starter when it is cranked for more than 10 secs. In such a case, get the key back to OFF position and wait for 30 secs before cranking again. This safeguards the starter motor as cranking continuously for more than 10 secs can damage the starter motor. Also immediately release the key after the engine has started, otherwise the flywheel ring/ starter motor may get damaged.

#### NOTICE

**Tata Indigo diesel** cars use Electronic Micro Processor Controller to control critical engine parameters like pre/post glow and cold advance. The glow plug and cold advance function will remain on even after starting of the engine depending on the engine coolant temperature at the start.

It is quite likely that at higher altitude (above 2000 meters) one may experience exhaust smoke being white in colour or engine hesitations in cold driving condition. The above observations are for few seconds only, and in order to contain the happening, it is suggested that after idle run of 30 seconds on a cold engine start, the car can be driven off.

## STARTING & DRIVING - Starting & Stopping

The above white smoke at altitude in cold condition from diesel engine is a normal happening, and due to temporary effect of atmospheric pressure. This in no way will affect the engine performance or the ecology.

### Starting the engine with a malfunction (Petrol):

- Press the clutch pedal and turn the ignition key to 'IGN' position.
- Press the accelerator pedal by 1/4th of full travel. Do not depress the accelerator pedal fully down.
- Crank the engine. If the engine starts, car may be driven to nearest authorised service outlet, even though “**CHECK ENGINE**” (BS-III) “**MIL**” (BS-IV) lamp is indicating a malfunction.
- In the above condition engine may stall if the accelerator pedal is released back to idle position.
- If engine stalls, repeat the above procedure from beginning & drive the car without releasing the accelerator pedal to 'Idle' position.

### Stopping the Engine :

- Let the car come to a stop and engine to idle.
- Turn the key to “OFF” position

### Parking :

- Park the car in a safe place. Switch on the indicator signal before turning to park.
- Apply the parking brake.
- Ensure that all window glasses are closed & all lamps are turned 'OFF'.
- At night, put on the parking lights if required.
- Remove the key from the ignition switch.
- Place wheel chocks at the wheels if parked on a slope.

**Read the Parking Brake section in “BEFORE DRIVING” for precautions on how to park the vehicle on a slope.**

### WARNING

Do not leave the key inside the car.

Do not leave children unattended in the car.

Avoid parking the car over inflammable materials, such as dry leaves, grass etc., as the exhaust system is hot enough to initiate 'FIRE'.

# STARTING & DRIVING - Preparing to drive

## Preparing to Drive :

The following checks and adjustments should be carried out before you start driving the car.

- Ensure that the windshield, all mirrors, windows and outside lights are clean. Check & adjust rear view mirrors.
- Ensure that the windshield washer reservoir is full.
- Ensure that the bonnet is properly closed.

### NOTICE

Do not put excessive pressure on top of bonnet to avoid damage.

- Check that any items that you may be carrying inside, are fully secured.
- Check & adjust seat.
- Ensure that all doors are locked properly.
- Fasten seat belt properly.
- Ensure that all gauges and indicator lights are working.
- Check for blind areas being unobstructed in front and rear of the car.
- Release the parking brake.
- Before driving off check in the rear view mirror, for oncoming traffic. Switch on side indicator signal when getting into main stream of traffic.

## Running-in instructions :

During running-in period i.e. first 1000 km. follow the running-in instructions given below :

1. After starting the engine do not rev it up. Warm up gradually at idling speed.
2. Avoid sudden acceleration and full throttle.
3. It is always preferred not to rev up a cold engine lest engine bearings get affected.

## Recommended car speeds during running-in period for diesel and petrol versions :

	DIESEL		PETROL
	TCIC	COMMON RAIL	MPFI
Gear	Speed (kmph)	Speed (kmph)	Speed (kmph)
1st	20	20	20
2nd	40	40	40
3rd	60	60	60
4th	80	80	80
5th	90	90	90



### Gear Shifting :

All forward gears being synchronised, provide for easy and effortless gear shifting. Always remember to press the clutch pedal fully while shifting the gears and also to release the clutch pedal gently.

Avoid sudden clutching i.e. abrupt release of depressed clutch pedal.

Do not shift into reverse gear when the car is moving forward or when the engine is not at idling r.p.m. A 5 second pause after declutching will ensure smooth engagement of the reverse gear. Change gears at appropriate gear change speeds.

### NOTICE

There is an interlock provided between fifth and reverse gear to prevent accidental shift from 5th gear to reverse gear. (Shifting from reverse gear to 5th gear is possible)

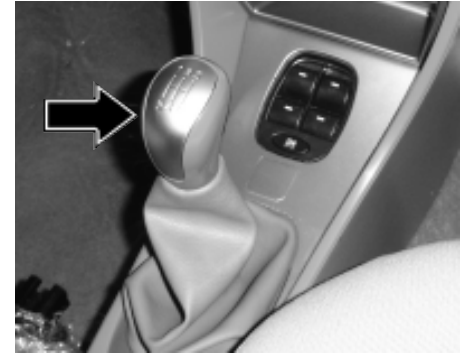
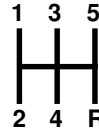

Gear Shifting Lever

# STARTING & DRIVING - Preparing to drive

---

## Gear Shifting

Appropriate gear change speeds for good pick-up :

<b>TCIC</b> Speed (kmph) Upshift	<b>COMMON RAIL</b> Speed (Kmph) Upshift	<b>MPFI</b> Speed (Kmph) Upshift
1st to 2nd-25-30	1st to 2nd-30	1st to 2nd - 25-30
2nd to 3rd-50-60	2nd to 3rd-60	2nd to 3rd - 50-60
3rd to 4th-80-90	3rd to 4th-90	3rd to 4th - 80-90
4th to 5th-100-110	4th to 5th-130	4th to 5th - 100-110

Recommended maximum speed, during normal operation.

<b>Gear</b>	<b>TCIC</b> Speed (kmph)	<b>COMMON RAIL</b> Speed (Kmph)	<b>MPFI</b> Speed (Kmph)
1	30	30	30
2	60	60	60
3	90	90	90
4	110	130	110
5	150	155	150

## STARTING & DRIVING -Fuel Economy

### INSTRUCTIONS TO IMPROVE FUEL ECONOMY :

Your car's fuel economy is mainly dependent on your style of driving.

To operate your car as economically as possible, use the following driving suggestions.

#### **Avoid Excessive Idling :**

Switch OFF the engine if you have to stop for more than a minute.

#### **Avoid fast starts & unnecessary stops :**

Start off slowly from traffic lights or stop signs to prevent excessive fuel consumption and reduced engine life. Avoid unnecessary deceleration (stopping or slowing down) and then acceleration which uses more fuel.

#### **Always maintain clean air-cleaner :**

The amount of air supplied will reduce due to clogged air-cleaner, resulting in waste of fuel due to incomplete combustion.

#### **Avoid incorrect tyre pressures :**

Under-inflated tyres result in increased running resistance of the tyres, leading to wastage of fuel.

**Always have the engine tuned correctly through recommended maintenance at an Authorised Service outlet.**

#### **Proper Driving Practices :**

Keep a safe distance from other vehicles to avoid braking suddenly.

Do not rest your foot on the clutch pedal. It does not allow full engine power to be transmitted to the vehicle and reduces clutch life.

#### **Fuel economy speeds :**

Gear	DIESEL		PETROL
	TCIC Speed (kmph)	COMMON RAIL Speed (kmph)	MPFI Speed (kmph)
1st	15	15	10
2nd	25	30	20
3rd	45	45	30
4th	65	60	40
5th	70	80	50

## STARTING & DRIVING - Fuel Economy

---

### MPFI System :

#### NOTICE

The multi point fuel injection system has been designed to meet various load and speed conditions of the engine and doesn't require any regular maintenance. MPFI system should be serviced by Authorised Service personnel only, if required.

### TIPS RELATED TO FUEL SYSTEM MAINTENANCE (MPFI):

Basically, the fuel system of the vehicle consists of the following main components :

1. Fuel tank
2. Fuel Filter
3. Fuel Pump
4. Fuel Rail
5. Fuel pressure regulator and
6. Fuel injector.

The following instructions are to be followed for reducing problems related to the fuel system.

- a) Avoid keeping the fuel tank empty and preferably keep it topped up as frequently as possible.

#### NOTICE

Empty fuel tank may lead to inner corrosion of the tank. The rust particles thus formed may result in frequent clogging of fuel filters. If the rust particles enter the system, it may result in malfunctioning of the MPFI system.

- b) Replace clogged fuel filters to prevent inconsistent fuel delivery from the fuel pump.

### Driving Through Water :

- Never venture to drive through water when it flows above the stone guard or above the tyre centre line.
- The engine may get seriously damaged if attempts are made to cross through deep water.
- If at all the situation demands that you have to drive through water even at great risk then, keep the engine in fast idling and 'crawl' in low gear.
- After driving through water apply the brakes several times to dry the liners and to regain original braking.
- Check the engine and transaxle for any water entry.

**Do not attempt to start the engine if the car gets flooded due to water.**



- Tow the car to a safe place.
- Take the car to the nearest Authorised Service outlet to check for entry of water in the engine.
- Lubricants in the engine and transaxle need to be changed in case of water entry.

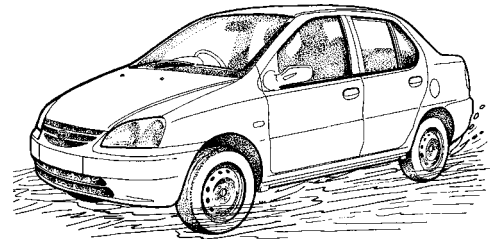

# STARTING & DRIVING - Driving in Adverse Condition

---

## Driving on a Rainy Day :

- Check wiper blades for proper functioning.
- Check brakes, steering and windows.
- Check tyres for wear and tyre pressure. Worn out tyres are unsafe on wet roads.
- Avoid harsh braking and sharp turns. It may cause loss of steering control and lead to the car skidding.
- For slowing down, shift to lower gears and apply brakes gently.
- Keep lights on if visibility is poor.
- Use heater and demister if required to clear off mist on the windshield.

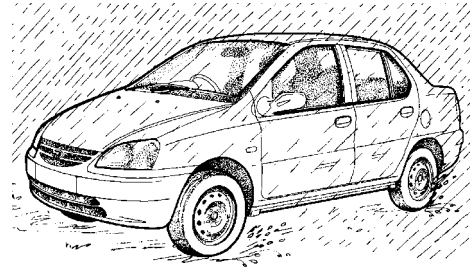

## Night Driving :

- Dip the head lamp for oncoming traffic during night driving.
- Maintain a speed such that you can stop within illuminated distance of the head lamps.
- Use head lamp main/dip beam to alert other users on turns/cross roads, etc.
- Use side indicators to indicate lane change or turning.
- Put on the hazard warning switch in case of hazardous parking or if your car is disabled to warn passing traffic. Put on the fog lamps (for Deluxe version) if required.

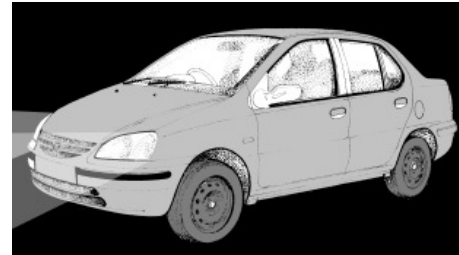

## STARTING & DRIVING - Driving in Adverse Condition

### Towing the Vehicle :

- For towing a car, the best way is to use a wrecker.
- Alternatively use a rigid tow bar.
- Avoid using a flexible cable or rope as your car may crash into the car towing your car when it stops suddenly.
- Switch 'ON' the hazard warning signals of both the cars to warn other road users.
- Where possible, keep the engine idling so that power steering assistance and brake vacuum are available.
- Limit the speed to 20-30 kmph.
- In case of brake failure, use the parking brake to control the car.

### Rear Tow Hook :

- Boltable tow hook is provided in the toolkit.
- Remove cover on rear bumper
- Bolt the tow hook (ensure proper fitment).
- Whenever tow hook is not required unscrew the tow hook and keep it in toolkit.
- Press the cover to close the hole for tow hook in rear bumper.



**Front towing hook**



**Rear Towing Point**

# STARTING & DRIVING - Driving in Adverse Condition

---

## DRIVING SAFETY

### Seat-Belt

Seat-belts are life saving equipment and their use reduces the chance of injury and severity of injury in case of an accident. It is strongly recommended that all the car occupants should always wear seat-belt, while car is in motion.

### Influence of Alcohol

Avoid driving under the influence of alcohol or drugs. Alcohol and drugs will severely impair your control on the vehicle and increase the risk of injury to yourself and others.

### Mobile phones

Avoid using mobile phones while driving. This could divert your attention from the road and result an accident.



### Fatigue 'Rest Revive Survive'

Do not attempt driving when you feel tired or sleepy. Long distance driving can tire you very much and fatigue can dull your reflexes and judgment. Take a break and get refreshed at intervals.

## CAR SAFETY CHECKS

### Windshield/wiper/windshield Washer

Always keep windshield glass clean to avoid any distraction in visibility. Ensure proper working of wipers and condition of wiper blade. Ensure that windshield washer reservoir is full. Do not operate wiper when the windshield glass is dry, This could damage the windshield.

### Headlights

Keep headlight lenses clean. Check for operation of headlamp in both high/low beam conditions. Check for correct focusing of headlamps. Use only recommended type of bulbs. Do not use the high beam unless it is inevitable. Its dazzle may glare the driver of the oncoming car, thus causing an accident.



## STARTING & DRIVING - Driving in Adverse Condition

### Side indicators / Hazard warning

Ensure that all side indicators/hazard warning lights are always in working condition and they are used when required.

### Horn

Ensure the horn is working properly. Horn provides safety to other road users by alerting your presence.

### Brakes

Ensure brakes are in working condition. Check brake fluid level in reservoir. Do not drive the car when brake warning lamp is 'ON'.

### Tyres

Check the condition of tyres for any abnormalities. Maintain correct tyre pressure, it is very important particularly

when subjected to extreme conditions, such as high speed, high load and high outside temperature. Do not use worn or bald tyres on the front wheels.

### First Aid Kit :

First aid kit is provided in your car. This is for use in case of minor injuries. It is to be regularly checked for any disintegration and should be updated regularly.

### Advance Warning Triangle :

There is an advance warning triangle provided along with your vehicle. In case there is a breakdown and the vehicle is parked at the side of road, then the triangle is to be kept as per instructions given below :

Remove advance warning triangle from case and assemble.  
Place the triangle on the road behind

the vehicle when it stranded on the road. The triangle must be at least 50 meters behind the vehicle in the same lane of traffic.

Increase the distance to 150 meters on a highway or if a bad/hill top obscures the view.



## STARTING & DRIVING

---

### ■ MAINTENANCE POINTS

- Engine Compartment
- Windshield Washer
- Air Filter
- Engine Cooling System
- Fuel System
- Transaxle Oil
- Clutch & Clutch Adjustment
- Brake & Brake Adjustment
- Power Steering
- Battery
- Starting the Engine with Jump Leads
- Catalytic Converter
- Turbocharger
- Intercooler
- EGR System
- Spark Plug
- Carbon Canister
- Wheel Change
- Wheel Alignment
- Wheel Balancing
- Tyres & Tyre Rotation
- Spare Wheel
- Repairing a Tyre/Tube
- Fuses & Relays
- Head Lamps & Head Lamp Adjustment

### ■ CAR CARE

- Washing
- Polishing
- Cleaning of Carpets
- Cleaning of Glass
- Wiper Care
- Paint Care

# MAINTENANCE POINT - Engine Compartment (TCIC)

---

## ENGINE COMPARTMENT-TCIC

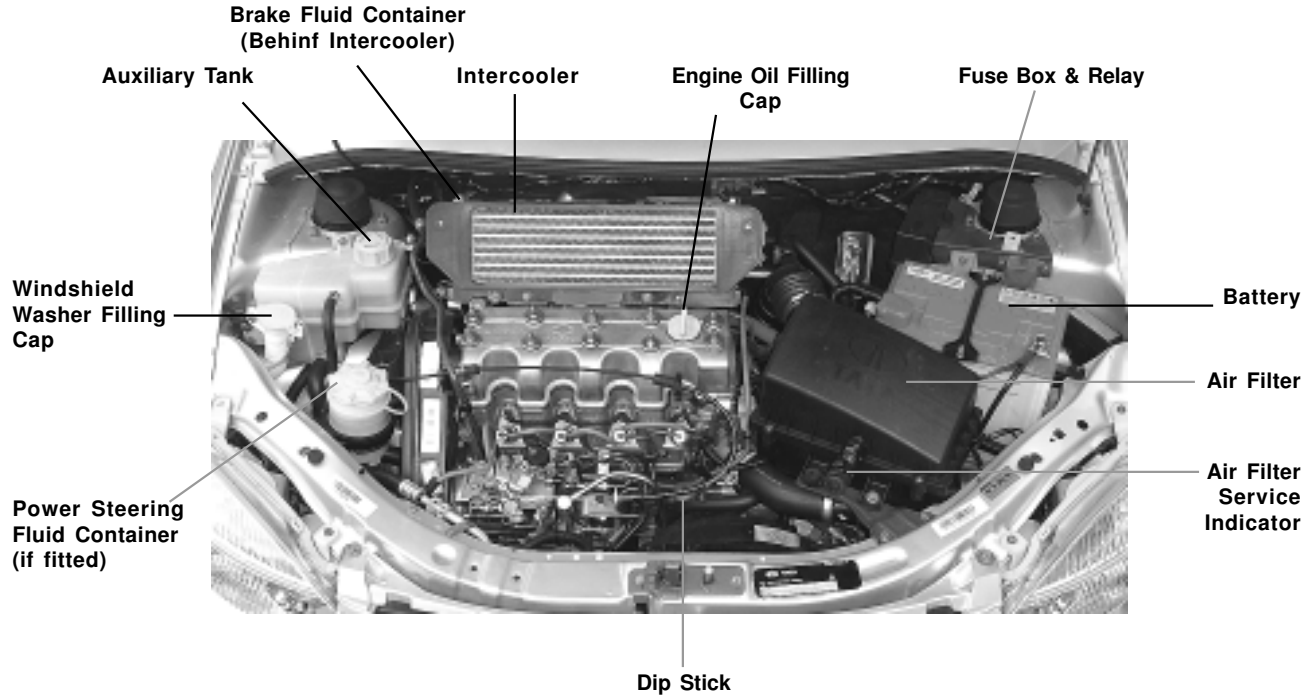

# MAINTENANCE POINT - Engine Compartment (Common Rail)

## ENGINE COMPARTMENT-COMMON RAIL

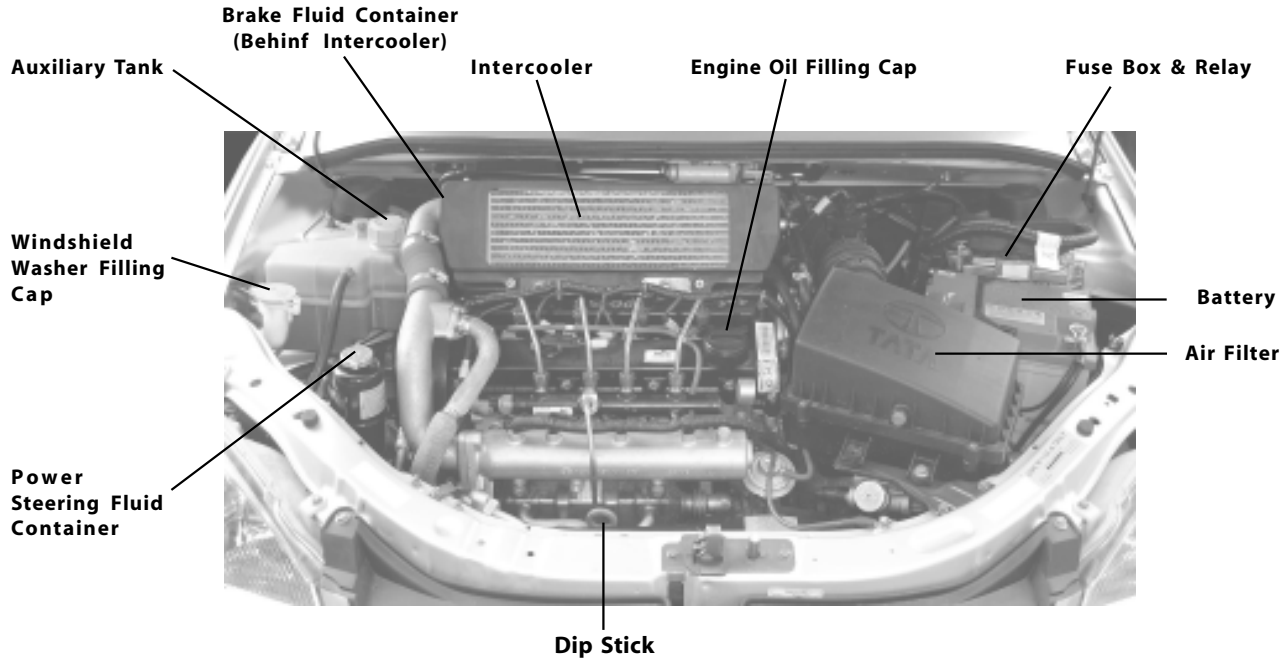

# MAINTENANCE POINT - Engine Compartment (MPFI)

---

## 475 SI MPFI PETROL ENGINE

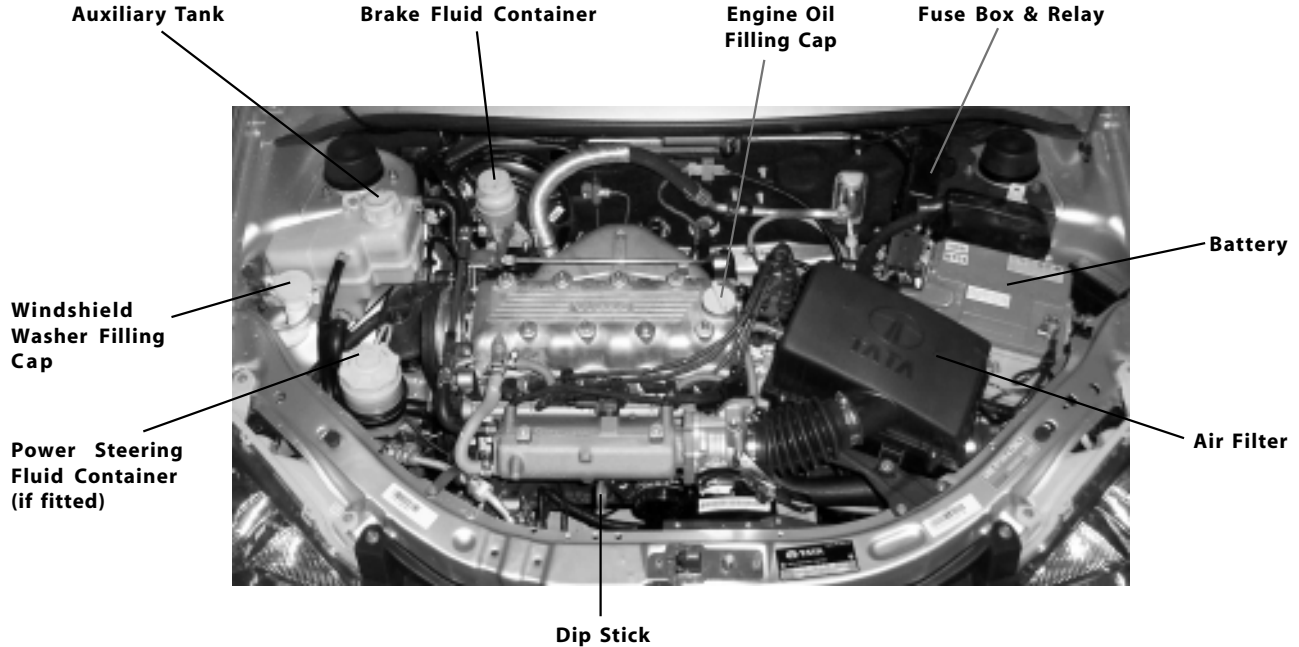

# MAINTENANCE & CAR CARE - Engine Compartment Lamp & Windshield Washer

## ENGINE COMPARTMENT LAMP : (if fitted)

Engine compartment lamp is provided to illuminate the engine compartment.

To push-pull type switch is provided to operate the lamp.

### NOTICE

Do not forget to switch 'OFF' the engine compartment lamp before closing the bonnet.

A provision has been made for installation of engine compartment lamp in the standard version.

## Windshield Washer :

Windshield washer fluid container is located behind the front right hand side panel and its filler neck is provided near auxiliary tank in the engine compartment.

### NOTICE

Do not add detergent or any solvent in the windshield washing water.

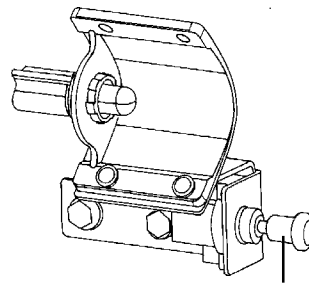

Push / Pull  
Type Switch

Engine Compartment Lamp



Windshield Washer Filler Cap

# MAINTENANCE & CAR CARE - Air Filter

## AIR FILTER :

The air filter element should be periodically cleaned. Replace the air filter element with a new one, when air cleaner service indicator shows red band, even after cleaning.

Always use a genuine air filter element. The air filter is located on the LH side of the engine compartment.

## Replacement of Air Filter Element :

- Remove the cover of the air filter, by removing the screws.
- Remove the air filter element.
- Clean it gently by tapping. Clean air filter cover and air ducting.
- Check the element for puncture or pin holes by holding against a bright light source.
- If found to be OK, reinstall the filter element. Fit the cover and plug on the clips.
- After cleaning, if the service indicator shows 'RED', replace air filter element.

### NOTICE

- When a car is driven under dusty conditions, frequent replacement of the air-cleaner element may be required.
- Clogged air-cleaners lead to greater intake resistance and result in increased fuel consumption. Using low pressure compressed air, blow off dust on the air cleaner element. If the air cleaner element appears to be choked, replace it with a new one.

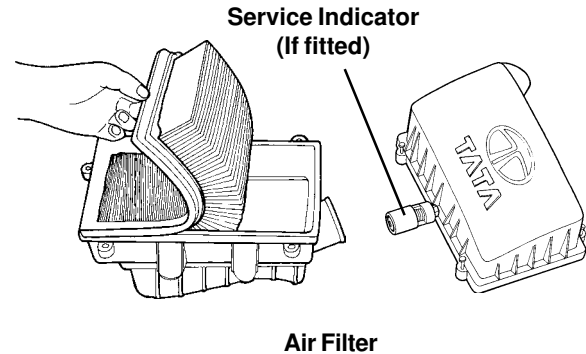



# MAINTENANCE & CAR CARE - Engine Cooling System

## ENGINE COOLING SYSTEM :

Check coolant level and top up if necessary.

If engine overheating occurs, there could be a fault in the cooling system which may be due to :

1. Insufficient coolant in the cooling system or dirt/scales having accumulated inside the cooling water passages especially in the radiator core.
2. Choking or damage of radiator passages.
3. Defective thermostat.
4. Non operation of electrically operated fan. (40 Amp. fuse blown)
5. Coolant leakage.
6. Auxiliary tank cap not sealing properly.
7. A.C. condenser fan not working.
8. Excessive refrigerant charging in the A.C. system.
9. Improper bleeding of the cooling system.

## Prevention of Rust Formation :

To prevent rust formation, use the branded premixed engine coolant in the radiator.

This is sufficient to operate the car upto  $-40^{\circ}\text{C}$ .

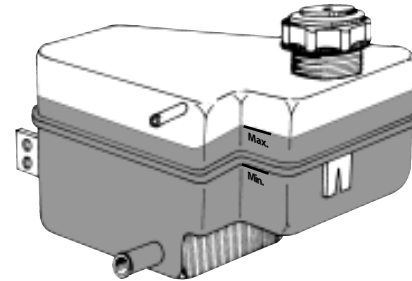

**Engine Coolant Container**

## MAINTENANCE & CAR CARE - Fuel Sedimenter (Common Rail)

### Fuel Sedimenter (Common Rail): (if fitted)

The water accumulated should be drained if the water in fuel sedimenter Indicator in the cluster glows during engine running.

Fuel sedimenter (If fitted) is the equipment fitted in fuel system to separate Water contents from diesel and to prevent the water from entering the Fuel System.

#### CAUTION

Water ingress in fuel system can result in system failure. A water sensor is fitted in the sedimenter to indicate to the driver that the sedimenter has to be drained. Check if water in fuel sedimenter indicator lamp in instrument cluster is 'ON' (if fitted).

#### NOTICE

If the water in fuel indicator comes ON, immediately take the vehicle to an Authorised service station.

### Limp - home mode operation :

When water gets accumulated in water sedimenter, "water in fuel indicator lamp" on instrument cluster remains ON continuously.



This causes the vehicle to run on "Limp Home Mode"; there is a drastic reduction in performance of the vehicle in Limp Home Mode.

#### NOTICE

At initial "Key-ON", the water in fuel lamp indication on the dashboard glows for 2 seconds and goes 'OFF' automatically. If this lamp does not glow, vehicle has to be taken to the service station for verification and necessary attention.

### FUEL FILLING CAP :

The fuel filler cap is located on the left rear side of the car. The fuel filler lid can be unlocked by pulling the opening lever located on the out-board side of the driver's seat and locked by simply closing the lid.

#### CAUTION

Remove the fuel filler cap slowly. The fuel may be under pressure & may spray out, causing injury if the cap is opened suddenly.

- Switch OFF the Engine when refueling.
- Do not use your mobile phone when you are at a Filling station.

# MAINTENANCE & CAR CARE - Fuel Filling Cap

## NOTICE

The fuel cap for petrol and diesel versions are of the vented type. For petrol, it is black in colour & for diesel it is in grey in colour. Use genuine and correct cap for replacement.

- To remove the fuel filler cap turn the cap anti-clockwise. Turn the cap slowly to allow any residual pressure to escape.
- To install turn the cap clockwise till a click sound is heard.

## WARNING

Fuel vapour are extremely hazardous. Always stop the engine before refueling and never fuel near sparks or open flames.

If you need to replace the fuel cap, use only specified for your car. Using an improper fuel cap can cause a serious malfunctioning of the fuel system. You can get the correct replacement from an authorised service outlet.

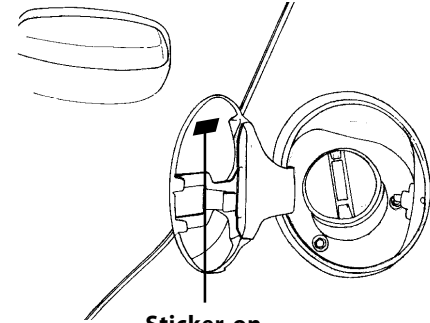

**Sticker on  
Fuel Filler Lid**

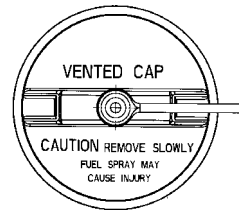

**Diesel  
(Grey colour)**

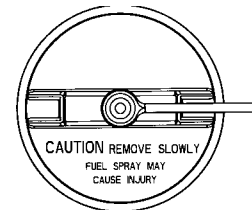

**Petrol  
(Black colour)**

# MAINTENANCE & CAR CARE - Transaxle Oil

---

## Transaxle Oil :

### Checking of Oil Level :

1. Clean the oil level plug and the surrounding area.
2. Remove the oil level plug and check whether oil is dripping out. The oil level must not be below the filler plug.  
Add oil to bring it to the required level.
3. Tighten the oil level plug to 3 - 4 mkg. torque.

### Changing Oil in Transaxle :

1. Let the engine idle for about 5 min. in neutral gear, so that the Transaxle is warmed up.
2. Clean the oil level plug, drain plug and surrounding area.
3. Place a container under the transaxle to collect the oil.
4. Remove the oil level plug.
5. Remove the drain plug and let the oil drain out fully.
6. Refit the drain plug with a new sealing washer. Tighten the oil drain plug and fill new recommended oil through the oil level plug. Tighten both the oil drain plug and oil level plug (with new sealing washer) to 3 - 4 mkg. torque.

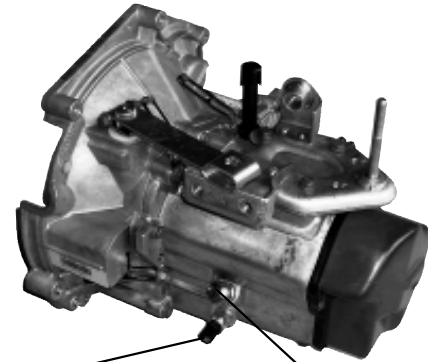

Reverse Light Switch

Oil Filler / Level Plug



Drain Plug

# MAINTENANCE & CAR CARE - Clutch & Brake

## CLUTCH :

Your car is provided with a single plate dry friction diaphragm type, pre-loaded release bearing clutch which is mechanically actuated by a cable connecting the clutch pedal & the clutch release lever.

There is no free play in the system and hence no clutch pedal free play adjustment is required although the clutch pedal height from the floor has to be adjusted as clutch lining wears and operate pedal 4-5 time and confirm no change in pedal height. The clutch pedal height from the floor keeps on increasing as the clutch lining wears. However, ensure that clutch pedal has free movement when lifted upward.

### NOTICE

- Do not ride the clutch. It will cause premature clutch wear.
- Do not release the clutch suddenly.

## BRAKES :

Dual circuit, diagonal split hydraulic brakes through tandem master cylinder have been provided. The front brakes are disc brakes with floating type calipers while the rear brakes are drum brakes with automatic adjustment. No adjustments are required for front & rear brakes. The parking brake is a mechanical lever type, console mounted, cable operated, acting on rear wheels. To operate, pull up. To release, pull the parking brake lever slightly up, press the release button and push down the lever. Pressure reducing valves are provided on both circuits for the rear brakes to avoid locking of wheels & skidding of the car. If parking brake lever travel is observed to be more than 6th notch, tighten the adjustment screw so that the parking brake lever stroke is between 3 to 6 notches. Jack up the rear wheels and ensure that the wheels are free to rotate in 6th notch.

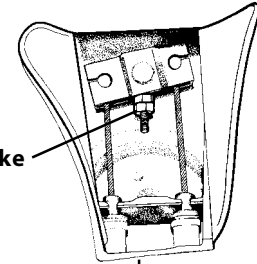
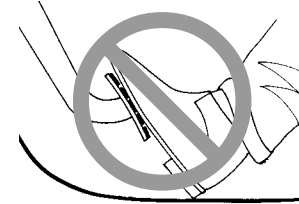

**Parking Brake  
Adjustment  
Screw**



## MAINTENANCE & CAR CARE - Brake & Brake Fluid

---

**BRAKES (Vacuum Assisted)** : The hydraulic brake system of your car is assisted by a vacuum booster which reduced the effort of driver during braking. In the unlikely event of disruption in supply of vacuum to the booster (e.g. stoppage of engine, or failure of vacuum hose) this assistance will still be available but only for one or two brake applications to bring the vehicle to a stop. Beyond this, vacuum assistance will not be felt by the driver and brakes will appear to be hard/ineffective. In order to stop the vehicle effectively the driver will have to apply a much higher force on the brake pedal (roughly 5 times the normal effort).

### CAUTION

Never drive the vehicle in engine switched "OFF" condition.

### **Brake Fluid :**

Check the level of brake fluid in the brake fluid container. It should be between the **MIN.** and **MAX.** marks.

If not, then add brake fluid. Clean the area surrounding the cap before opening the cap. Always use fresh brake fluid and tighten the cap fully, otherwise moisture from the atmosphere will be absorbed by the brake fluid, making it unserviceable.

In case of spongy or hard pedal or low brake efficiency, please contact the nearest Authorised Service outlet and get the defect rectified.

## MAINTENANCE & CAR CARE - Power Steering

### POWER STEERING (if installed)

Power steering is fitted for lighter steering effort and easy manoeuvrability, during driving and also help absorb the road shocks. The system consists of steering gear box, hydraulic pump and hydraulic tank. Pump drive is through the poly 'V' belt from the engine. Power assistance is available during normal operating conditions. In case of failure in the hydraulic system, the steering can be operated mechanically to bring the car to an Authorised Service outlet.

#### CAUTION

Report any external leakage to the nearest Authorised Service outlet.

#### WARNING

Do not allow fluid level to drop significantly or run out of the reservoir during the above operation. This may induce air into the system.

Severe damage could occur to the power steering pump due to dry running (Running without sufficient oil and due to severe cavitation on account of air entry due to low oil level). This could lead to loss of power assistance, damage and failure of the power steering system.

Do not start the engine without oil in the power steering system. This will result in serious damage to the pump. In case of an emergency, disconnect the pump drive belt and then start the engine or drive slowly as vacuum assistance for brake would not be available (as vacuum pump is also being driven by same belt).

Always use recommended oil from sealed containers. Any contaminated oil poured in the system will result in damage to the pump and gear box.

Avoid mixing of different brands of oils.

## MAINTENANCE & CAR CARE - Battery

---

### BATTERY :

Check the battery for proper electrolyte level and corrosion on the terminals.

#### WARNING

During normal operation, the battery generates gas which is explosive in nature, a spark or open flame can cause the battery to explode causing very serious injuries.

Keep all sparks & open flames and smoking materials away from the battery.

Getting electrolyte in your eyes or on the skin can cause severe burns. Wear protective clothing and a face shield or have a skilled technician to do the battery maintenance.

The battery contains sulphuric acid (electrolyte) which is poisonous and highly corrosive in nature.

1. Check the battery for electrolyte level against the marking on the battery outer case.
2. Check the battery terminals for corrosion (a white or yellowish powder). To remove it, cover the terminals with a solution of baking soda. It will bubble up and turn brown. When this stops wash it off with plain water. Dry off the battery with a cloth or paper towel. **Coat the terminal with petroleum jelly to prevent future corrosion.**

Use a proper wrench to loosen and remove cables from the terminals. **Always disconnect the negative (-ve) cable first and reconnect it last.**

Clean the battery terminals with a terminal cleaning tool or wire brush.

Reconnect and tighten the cables, coat the terminals with petroleum jelly.

If you need to connect the battery to a charger, disconnect both cables to prevent damage to the vehicle's electrical system.

#### NOTICE

Charging the battery with the cables connected can seriously damage your vehicle's electrical/electronic equipment.

Detach the battery cables before connecting the battery to a charger.

#### CAUTION

Swallowing electrolyte can cause fatal injury if immediate action is not taken. Do not reverse the battery connection on the vehicle as it may damage the vehicle electricals.

#### NOTICE

Negative terminal is connected to the body/cab.



## MAINTENANCE & CAR CARE - Battery

### Starting the Engine with Jump Leads :

The engine with a discharged battery may be started by transferring electrical power from a battery in another car.

This may be dangerous as any deviation from the following instructions could lead to personal injury resulting from any battery explosion, as well as damage to the electrical systems in both cars.

#### **⚠ CAUTION**

Do not allow battery electrolyte to come in contact with eyes, skin, fabrics or painted surfaces. The fluid contains sulphuric acid which can cause injury and severe damage. Wear rubber gloves, to avoid risk of contact.

- To lessen the risk of injury, wear eye protection when working near any battery.
- Make sure that the battery providing the jump start has the same voltage as the battery in your car (12 V). Its capacity must be approximately the same as the original battery capacity. The voltage and capacity are given on the batteries.
- Do not disconnect the discharged battery from the car.
- Switch off all unnecessary electrical loads.
- Do not lean over the battery during jump starting.
- Do not allow the terminals of one lead to touch those of the other lead.
- Apply the hand brake. Keep the gearshift lever in neutral.

Connect leads in the order as shown in the sketch :

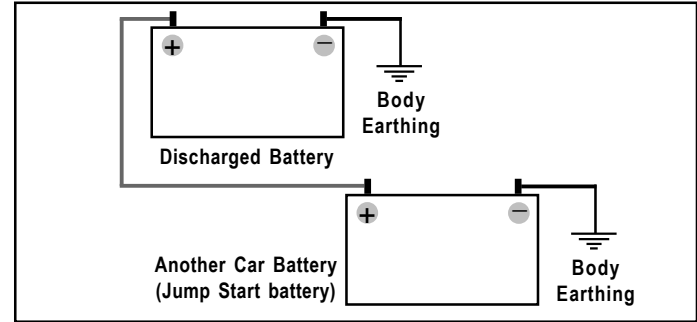

- Do not connect the lead to the negative terminal of the discharged battery.
- The connection of the -ve lead point should be as far away from the discharged battery as possible and close to the starter motor on engine/transaxle.
- Route the leads so that they cannot get caught by the rotating parts in the engine compartment.
- The engine of the car providing the jump start can be allowed to run during starting.

Attempts to start the engine of the car with the discharged battery should be made at intervals of one minute and should not last more than 15 seconds. After starting, allow both engines to idle for approximately 3 minutes with the leads still connected.

# MAINTENANCE & CAR CARE - Catalytic Converter

---

## Catalytic Converter (DIESEL):

To reduce exhaust pollution, the vehicle is fitted with Diesel Oxidation Catalytic Converter. The two way Catalytic Converter has coating of precious metals which enables conversion of pollutants.

## Oxidation Catalytic Converter (Diesel) Common Rail:

Two numbers of Oxidation catalytic converters are fitted on your car to reduce exhaust pollution. The two way catalytic converters are having coating of precious metals which enables conversion of pollution. The Oxidation catalytic converters will quickly heat up after starting to ensure that it operates correctly during the warm up phase of the engine.

## Care of the Catalytic Converter :

The catalytic Converter does not require any special maintenance however, following precaution should be taken for the effective functioning of the converter and to avoid damage to the Converter.

- Always use fuel of recommended specifications. Use of any other diesel fuel can increase the pollutants.

### CAUTION

Avoid parking the vehicle over inflammable materials, such as dry leaves, grass etc., as the exhaust system is hot enough to initiate 'FIRE'.

## Catalytic Converter (PETROL):

The catalytic converter is fitted on your car to reduce exhaust pollution. The catalytic converter will quickly heat up after starting to ensure that it operates correctly during the warm up phase of the engine. **On a car with a catalytic converter, the fuel tank filler neck is of reduced diameter compatible with standard unleaded petrol supply nozzle.**

### NOTICE

Even one time use of leaded petrol may cause permanent damage to the catalytic converter. Hence use unleaded petrol of recommended specifications only.

## Care & Maintenance :

- Use Unleaded Petrol only, since use of Leaded Petrol will damage (poison) the Catalytic Converter permanently.
- Consult an Authorised Service Outlet at the earliest when,
  - Engine misfires or runs irregularly, following a cold start,
  - A significant loss of Power is noticed.
- In the event of above symptoms, drive the car at slow speed without rapid acceleration. If the vehicle is continuously run with misfiring, it may cause overheating of shell, carpet etc. resulting into fire.

# MAINTENANCE & CAR CARE - Catalytic Converter & Turbocharger

## Avoid

- Push start or tow-starting the vehicle. (Use jump leads).
- Long (not more than 10 sec.) repeat (not more than 3 times) starting of the Vehicle. Investigate the cause for difficulty in starting & rectify the same.
- Long idling (to warm-up). If the engine is running rough, after a cold start.
- Switching 'OFF' the ignition when driving down the hill. (This will not save fuel).
- Fuel tank getting almost empty.
- Idling the engine with any of the Spark Plug Cable disconnected, manually, during diagnostic test. (Use appropriate test equipment).
- Pre-Coating/Painting of Catalytic Converter.

## Parking Warning :

Avoid parking the vehicle over inflammable materials, such as dry leaves, grass, etc., as the exhaust system is hot enough to initiate "FIRE".

## Turbocharger (If fitted) :

Your car is fitted with a turbocharger. Turbocharger is an efficient supercharging device used in our engine. It makes use of thermal energy of engine exhaust gases to run a turbine which in turn drives a compressor to force air under pressure into the inlet manifold.

## Lubrication of Turbocharger :

The turbocharger rotor assembly is supported by two fully floating bearing bushes in the bearing housing. These bearing bushes are lubricated with finely filtered engine oil from the lubrication system of the engine.

Idle the engine for a while (one minute) after starting the engine and before stopping the engine to ensure adequate lubricating oil supply to the turbocharger.

## Turbocharger Connections :

All turbocharger connections must be leak-proof. Check air inlet, air outlet, exhaust gas inlet and exhaust outlet connections as well as oil inlet and outlet connections to the turbocharger and tighten the connections where required.

Proper maintenance of air filter, oil filter as well as use of correct grade of oil and adherence to oil change intervals is essential for proper functioning of the turbocharger.

If you suspect any malfunctioning of the turbocharger, take the vehicle to the nearest dealer. Do not remove the turbocharger yourself.

## MAINTENANCE & CAR CARE - Intercooler

---

### Intercooler (If fitted):

Hot air coming out of turbocharger flows the inter cooler and gets cooled before entering the intake manifold. The inter cooler is mounted on top of cylinder head cover.

As such it does not require any maintenance however it can be cleaned externally ( when it is not hot) by blowing compressed air through its fins.

### Maintenance recommendations:

- Check the boost pressure pipe for its proper fitment, damage etc.
- Specified engine and the oil filter should be used and should be changed regularly in accordance with Service Schedule.
- Check oil feed pipes, return pipes, air intake and exhaust piping for leakages and restrictions.
- Check the engine breathing system and oil separator.
- Fill the oil inlet hole of the turbo charger with clean engine oil, when the engine is started after long storage.

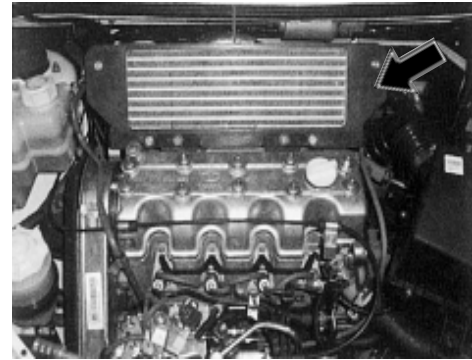

Intercooler (TCIC)



Intercooler (Common Rail)

### EGR System : ( Common Rail engine)- if fitted

To reduce exhaust pollution from your car, the engine is provided with exhaust gas recirculation (EGR) system.

The EGR system consists of an EGR valve, EGR cooler and EGR pipe. The continuously variable EGR valve is controlled by ECU. A controlled amount of exhaust gas is mixed with intake air, in part load and part throttle conditions. This helps in reducing harmful emissions.

In addition to EGR System your car is also fitted with diesel oxydation catalytic convertor to reduce exhaust pollution.

#### NOTICE

Use diesel fuel of recommended specifications. Use of any other diesel fuel can increase the pollutants.

#### WARNING

Avoid breathing exhaust gases. This contain carbon monoxide which is harmful.

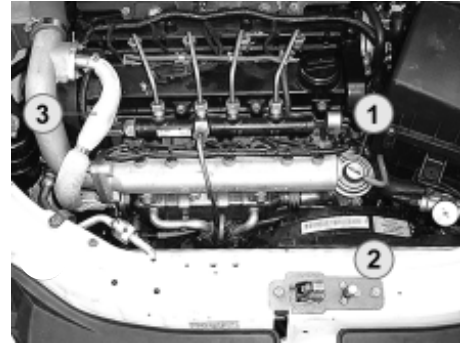

1. EGR Valve
2. EGR Cooler
3. EGR Tube



4. Electronic Vacuum Regulator (EVRV)

# MAINTENANCE & CAR CARE - Spark Plug

## SPARK PLUG (Petrol Engine) :

Spark Plug	-	Mico
Spark Plug No.	-	FR6 DC4
Spark Plug Gap	-	0.7 mm to 0.8 mm

You should inspect the spark plugs periodically for carbon deposits. When carbon accumulates on the spark plug, a strong spark will not be produced. Remove carbon deposits using a spark plug cleaner.

### Spark Plug Replacement :

1. Clean up any dirt or oil that is collected around the spark plug caps.
2. Pull out the spark plug cables by gripping at the connector.
3. Remove the spark plug with the help of a special socket.
4. Check and adjust the gap, it should be 0.7 mm to 0.8 mm.
5. Replace the spark plug if the gap is more than 1.2 mm.
6. Fix the spark plug and tighten it to the torque of 25 Nm (dry).
7. Fit the spark plug cable, until a 'click' sound is heard. Repeat the procedure for the other spark plugs.

### NOTICE

Tighten the spark plug carefully. Overtightening can damage the threads in the cylinder head. A loose spark plug or loose spark plug cable can affect combustion and cause damage to engine and catalytic converter.

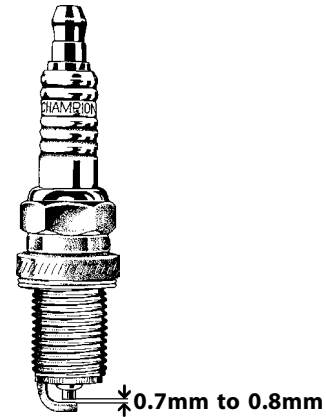

### **CARBON CANISTER (Petrol Engine) :**

As petrol evaporates in the fuel tank, hydrocarbons are discharged into the atmosphere. The carbon canister stores these hydrocarbons from the fuel tank.

Air drawn through the carbon canister into the engine should be controlled to maintain exhaust emissions within desired limits as well as to ensure good driveability.

The carbon canister should be replaced at an Authorised Service outlet.

# MAINTENANCE & CAR CARE - Wheels & Tyres

## WHEELS & TYRES :

Always use only the recommended size of wheel rims & tyres. Use of non-recommended rims and tyres may have an adverse effect on car safety and furthermore could infringe on car regulations.

### Wheel Change :

When changing wheels, use the jack provided with the car. The jack with handle is located on tailgate inner sill.

- Park the car on a safe level ground. Engage 1st gear and also apply the parking brake. Place wheel chocks behind the rear wheels and in front of the front wheels.
- Remove the wheel rim cover (if fitted) which is snap fitted.
- Loosen the wheel pins of the wheel to be changed slightly. Keep the spare wheel to be fitted nearby.
- Jack up the car by placing the jack at the appropriate location.
- Remove the wheel pins and the wheel.
- Fit the new wheel and tighten the wheel pins.
- Lower the jack and tighten the wheel pins to 8 mkg. torque. Fit the wheel rim cover.

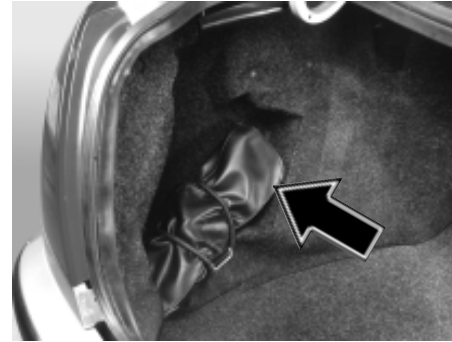

Tool Kit

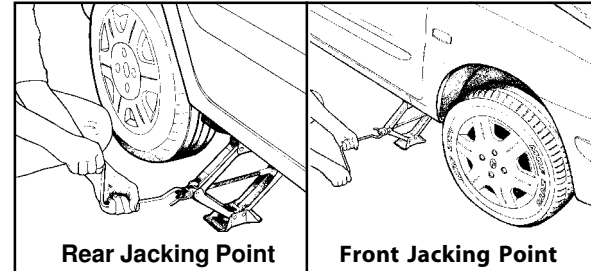

### NOTICE

The jack should never be supported on any of the body sheet metal components. This can cause damage to the body. Do not apply oil on the wheel pins. Wipe off the oil if present.



## MAINTENANCE & CAR CARE - Wheels & Tyres

- The jack should be placed below the body sill behind the front wheel tyre for front wheel changing and before the rear wheel tyre for rear wheel changing. Please refer to the sticker (Jack location) fixed on the jack.

### CAUTION

Do not work under the jacked up car without proper support.



### Wheel Alignment :

Correct wheel alignment helps to ensure uniform tyre wear. You should get your car's wheel alignment checked regularly as per recommendation.

In case uneven tyre wear is observed, the vehicle's wheel alignment should be checked as soon as possible.

### Wheel Balancing :

Wheels are balanced at the factory. They have to be rebalanced as per recommendations.

The wheels should be checked for balance if a tyre or tube is repaired.

Whenever a tyre or wheel rim is changed, the tyre needs to be balanced.

1. Permissible imbalance for tyre with rim = 95 gm. cm. (max.)
2. Total balance weight should be within 140 gm on each side.

## MAINTENANCE & CAR CARE - Wheels & Tyres

---

3. Relocate the tyre on the wheel rim if the weight required to balance is more than 140 gm.
4. Balance weights are available from 5 gm to 140 gm, in steps of 5 gm.
5. Do not use more than one balance weight on one side.

### TYRES :

Check for inflation and condition of your car tyres periodically.

### Inflation :

Check the pressure in the tyres when they are cold.

Refer to the tyre information label fitted on the driver side doorpost for correct cold tyre pressure.

**Recommended Tyre Pressures :** (with cold tyres)

**For tyre pressure (Refer page 'Filling Station Information')**

You should have your own tyre pressure gauge and use it at all times. This makes it easier for you to tell if pressure loss is caused by a tyre problem and not by variation between gauges.

Keeping the tyres properly inflated gives you the best combination of riding comfort, handling and tyre life.

Over inflation of tyres makes the car ride bumpy and harsh. Tyres are more prone to uneven wear and damage from road hazards.

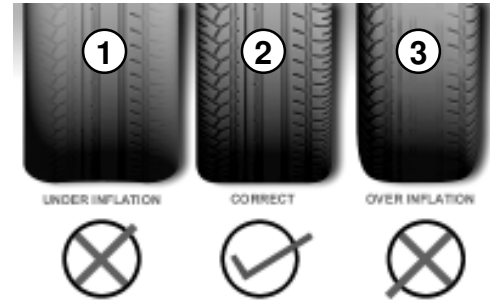

1. **Underinflation** - Excessive Side Tread Wear
2. **Correct Tyre Pressure** - Uniform Tyre Wear
3. **Overinflation** - Excessive Centre Tread Wear

# MAINTENANCE & CAR CARE - Wheels & Tyres

Under inflated tyres reduce your comfort in car handling and are prone to failures due to high temperature. They also cause uneven wear and more fuel consumption.

## Inspection :

### ⚠ CAUTION

Every time you check inflation pressure, you should also examine tyres for leakage, damage, foreign objects & wear.

## You should look for :

### ⚠ CAUTION

- Bumps or bulges in the tread or the side of the tyre. Replace the tyre if you find either of these conditions.
- Cuts, splits or cracks in the side of the tyre. Replace the tyre if you notice this on the fabric or cord.
- Excessive tread wear or non uniform tyre wear.

## Tyre Rotation :

To help increase tyre life and distribute wear more evenly you should have tyres rotated at specified intervals or earlier depending on the operation of car and tyre wear pattern.

The illustration shows how to rotate tyres when a normal spare wheel is included in tyre rotation.

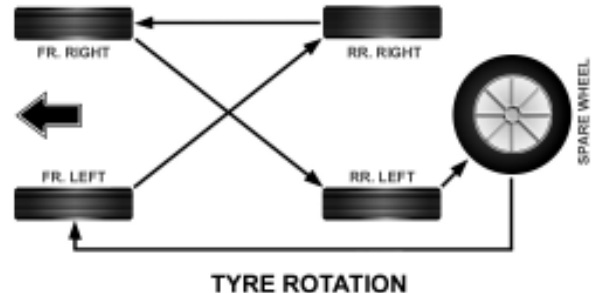

## MAINTENANCE & CAR CARE - Wheels & Tyres

---

### Spare Wheel :

It is located in the luggage compartment.

- To take out the spare wheel, first fold in and lift up the floor cover.
- Unscrew and remove retaining bolt, at the centre.
- Lift and take out the spare wheel.

### Repairing a Tyre/Tube :

Mark the tyre position suitably (if original colour dot mark is not visible) with respect to valve stem hole to ensure that the tyre is refitted in the original location on the wheel rim.

Check the balance weight prior to the removal of the tyre. If found loose, mark its location on the rim & refit properly.

Balance the wheel after every dismantling and assembly of tyre on the wheel rim.

While fitting wheels on the car ensure that wheel pins are free from dust, scratches, dirt, dents, etc.

Ensure the tube being replaced has the correct valve.



Spare wheel

### NOTICE

Do not apply any oil on the wheel pins. Wipe off the oil if present.

# MAINTENANCE & CAR CARE - Fuses & Relays

## Fuses & Relays :

The electrical circuits in your car have fuses to protect the wiring from accidental short circuit or sustained overload. Fuses and relays are located at 3 locations in your car as shown in the sketch.

Circuit connected through fuses and relays and the amperage of the fuse is printed on the fuse box covers.

## Checking and replacing fuses :

If any electrical unit in your car has stopped functioning, the fuses should be checked first.

- Turn the ignition key to 'LOCK' position.
- Remove the fuse box cover, locate the fuse for the function.
- Remove the fuse & look for the fuse element inside the fuse. If it is damaged replace it with a fuse of same rating and type. Push the fuse firmly into the holder.
- Check that all other fuses are firmly in position & fix the cover back in position. Spare fuses are provided in the fuse box in the cabin.

If the replaced fuse of the correct rating burns out in short time, there is probably a serious electrical problem in your car. Get the car attended to at the nearest Authorised Service outlet.

If any of the function relays is found defective, replace it by a genuine relay.

## LOCATION OF FUSE BOX & RELAYS

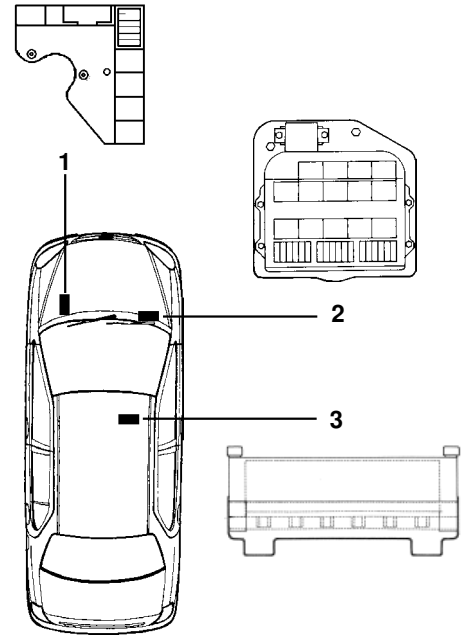

1. Engine compartment.
2. Cabin compartment under dashboard.
3. Cabin compartment under driver's seat (if installed).

# MAINTENANCE & CAR CARE - Head Lamp

## CAUTION

The electrical system is protected by fuses that are designed to foil and prevent damage to wiring harness. Always replace blown fuse with the same rating as specified to prevent wiring damage that can result in a possible fire.

### Head Lamps :

The head lamps are provided with two halogen lamps of H1 (High beam) / H7 ( Low beam) type with single filament for providing straight ahead illumination of the road for long distance or a dip beam which illuminates the road immediately ahead for short distance visibility. Use dip beam to avoid inconvenience / blinding the drivers of oncoming vehicles.

The head lamps must be properly aligned in order to obtain maximum road illumination and reduced glare for oncoming traffic. It is recommended to check alignment of head lamp beams periodically at authorised service outlets

Head lamp focus adjustment should be always carried out at the authorised service outlets with the help of screen

### Head Lamp Bulb Replacement :

- Switch 'OFF' the head lamps & ensure that the bulb is not hot.
- Open the bonnet and remove the lamp connector from the head lamp bulb.
- Remove rubber cap. Unlock the locking clip and take out the



1. Indicator Lamp
2. Rubber Cap
3. Low Beam Bulb
4. Rubber Cap
5. High Beam Bulb
6. Parking Lamp

## MAINTENANCE & CAR CARE - Head Lamp

bulb from the holder. This should be done carefully, otherwise it may lead to breakage of the bulb holder / holding clip.

- Note the instructions on the bulb carton.  
Replace the bulb with a new one of the same type with right orientation in the holder.
- Lock the clip, fit the rubber cap and fix the connector.
- Switch 'ON' the head lamps and check the lighting.

### CAUTION

Do not clean or touch the head lamp reflector as it will damage the mirror finish of the surface.

The horizontal and vertical adjustment screws are located on the back of the reflector.

Precise adjustment can be carried out only in the authorised workshops.

When replacing the head lamp bulb, handle it by gripping the cap. Protect the glass from contact with your skin or hard object. If you touch the glass, clean it with spirit & a clean cloth. After replacement of the bulb in any emergency get the head lamp adjustment done at an Authorised Service outlet at the earliest.

### CAUTION

Halogen head lamp bulbs get very hot when illuminated. Oil, perspiration or a scratch on the glass can cause the bulb to break due to the heat.

# MAINTENANCE & CAR CARE - Car Care

---

## CAR CARE :

The car is subjected to many external influences such as climate, road conditions, industrial pollution and proximity to the sea. These conditions demand regular care of the car body. Dirt, insects, bird droppings, oil, grease, fuel and stone chippings should be removed as soon as possible.

### Washing :

Do not wash the car in direct sunlight, wash in shade. Spray the car thoroughly with a cold water jet (car on a washing pit or hoist). Mix car shampoo in the wash water. No solvent (fuel, thinners) need be used.

#### NOTICE

Avoid wiping of painted surface in dry condition as it may leave scratches on the painted surface.

Use a soft bristle brush, sponge or soft cloth and rinse it frequently while washing. When you have washed the whole exterior, dry it with a chamois or soft cloth. After drying the car, inspect it for chips and scratches that could allow corrosion to start. Apply touch up paint where necessary.

### Polishes :

Polishes and cleaners can restore shine to the painted surface that has oxidised and become dull. They normally contain

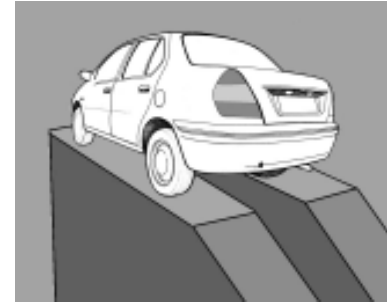

**Car on Washing Pit**

mild abrasives and solvents that remove the top layer of the finish coat. Polish your car if the finish does not regain its original shine after using wax.

### Cleaning of Carpets :

Vacuum clean the carpet regularly to remove dirt. Dirt will make the carpet wear out faster. Periodically shampoo the carpet to keep it looking new.

Use carpet cleaners (preferably foam type). Follow the instructions that come with the cleaner, applying it with a sponge or soft brush. Keep the carpeting as dry as possible by not adding water to the foam.



## MAINTENANCE & CAR CARE - Car Care

### Cleaning of Windows, Front & Rear Glass :

Clean the windows inside and outside with commercially available glass cleaners.

This will remove the haze that builds up on the inside of windows. Use a soft cloth or paper towels to clean all glass and plastic surfaces.

### Maintaining the car when not in extended use :

Park the car in covered, dry and if possible well-ventilated premises.

Engage a gear.

Remove the cables from the battery terminals (first remove the cable from the negative terminal).

Make sure the handbrake is not engaged.

Clean and protect the painted parts using protective wax.

Clean and protect the shiny metal parts using commercially available special compounds.

Sprinkle talcum powder on the rubber windscreen wiper and rear window wiper blades and lift them off the glass.

Slightly open the windows.

Cover the car with a cloth or perforated plastic sheet. Do not use sheets of imperforated plastic as they do not allow moisture on the car body to evaporate.

Inflate the tyres to 0.5 bar above the normal specified pressure and check it at regular intervals.

Check the battery charge every six weeks.

Do not drain the engine cooling system.

### Wiper Care :

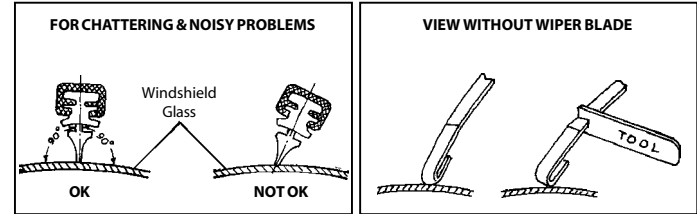

Wiper blade attack angle on windshield glass should be  $90^\circ$  i.e. perpendicular.

Remove wiper blade and root wiper arm on windshield glass in the centre position. Check the gap between arm strip and glass.

Adjust by twisting wiper arm as shown in the figure.

# MAINTENANCE & CAR CARE - Car Care

---

## **FOLLOWING GUIDELINES WILL HELP YOU TO BETTER PROTECT YOUR CAR FROM CORROSION**

### **PROPER CLEANING :**

In order to protect your car from corrosion it is recommended that you wash your car thoroughly and frequently in case :

1. There is an heavy accumulation of dirt and mud especially on the underbody.
2. It is driven in areas having high atmosphere pollution due to smoke, soot, dust, iron dust & other chemical pollutants.
3. It is driven in coastal areas.
4. The underbody must be thoroughly pressure washed after every three months.

In addition to regularly washing your car, the following precautions need to be taken.

### **PERIODIC INSPECTION :**

1. Regularly inspect your car for any damage in the paint film such as deep scratches and immediately get them repaired from an Authorised Service Centre, as these defects tend to accelerate corrosion.
2. Inspect mud liners for damages.
3. Keep all drain holes clear from clogging.

### **PROPER PARKING :**

Always park your car in shade to protect it from harsh sunlight or in a well-ventilated garage so that there is no dampness on any part of the car.

### **WASHING YOUR CAR :**

Follow these tips while washing your car.

### **HAND WASH :**

1. Always wash your car in shade and when the surface is at room temperature.
2. Wash with mild car wash soap like "Car Shampoo" and use a soft 100% cotton cloth to avoid scratches. Please take help of your dealer to buy the right products.
3. Please be sure that you remove your wristwatch and wear soft gloves to avoid scratches due to finger rings or nails.
4. To remove stubborn stains and contaminants like tar, use turpentine or cleaners like "Stain Remover" which is safe for painted surfaces. Again your dealer can help you in selecting the right product.
5. Avoid substances like petrol, diesel, kerosene, benzene or other solvents that cause damage to paint.
6. Dry your vehicle thoroughly to prevent any damp spots.
7. Rinse all surfaces thoroughly to prevent any traces of soap and other cleaners as this may lead to the formation of stains on the painted surface later.

## MAINTENANCE & CAR CARE - Car Care

---

### **WAXING :**

Waxing and polishing is recommended to maintain the gloss and wet-look appearance of your paint finish.

1. Use a good quality polish and wax for your car.
2. Re-wax your car when the water does not slip off the surface and collects over the surface in patches.

### **Further tips for the care of your new CAR finish :**

We recommend that you do not use an automatic car wash as the stiff brushes or sponges could mar the finish and damage the surface of your car. Wash the vehicle by hand with cool and clean water using a soft cloth or sponge. Please do not use soap but a car shampoo recommended by your dealer.

### **Please take the following precautions :**

1. Always wash your car in shade, avoiding direct exposure to sunlight during washing.
2. Dry wiping your car may lead to the formation of scratches and hence always use a soft cloth and clean water while wiping your car.
3. Always keep your car parked in a well ventilated shade. Exposure to heat with entrapped moisture promotes corrosion.

4. Avoid driving on gravel roads, as the possibility of paint chip off due to the impact of stones is high. If you are driving on freshly tarred road, check immediately afterwards for any stains & clean them.
5. External contamination in the form of sap or industrial fall-out may mar or develop spots on a new finish. Hence avoid parking your car near trees, which are known to drop sap, or near factories, which give out heavy smoke.
6. The acid content in bird droppings may damage the newly painted finish and hence any bird dropping must be immediately washed off.
7. The paint finish is susceptible to damage in case petrol, brake fluid, liquid from car battery, oil, antifreeze, transmission fluid or windshield solvent spills onto the painted surface. In case of such a spillage immediately rinse the affected area with water. Avoid wiping the area as far as possible, however if wiping is required, ensure that you wipe the area gently with soft cotton cloth.
8. Avoid using sharp objects to scrap off tar or mud from a painted surface as it may develop scratches or may peel off the paint.

## **MAINTENANCE & CAR CARE - Car Care**

---

## ■ EMERGENCY SERVICE TIPS

- Engine
- Clutch
- Transaxle
- Brakes
- Steering System
- Electrical
- Suspension

## EMERGENCY SERVICE TIPS - Engine (Diesel)

These tips are given for your guidance. These preliminary jobs are to be carried out in an emergency. In normal cases the problems should be attended to in an Authorised Service outlet by following the repair procedures given in the Workshop Manual.

SR. NO.	PROBLEM OBSERVED	PROBABLE CAUSE	ACTION TO BE TAKEN
<b>ENGINE (DIESEL)</b>			
1.	<b>Engine not cranking</b>	Dead battery, loose or improper battery/electrical connections	<ul style="list-style-type: none"> <li>• Get battery checked and/or changed</li> <li>• Jump start using another battery</li> <li>• Clean &amp; tighten connections</li> </ul>
2.	<b>Engine cranks but does not start</b>	Air in the fuel system	<ul style="list-style-type: none"> <li>• Get the air removed by bleeding</li> <li>• Check leakages &amp; correct</li> </ul>
3.	<b>Check Engine/MIL lamp continue to glow, even after start</b>	Engine stop solenoid fuse blown Some fault are detected by the ECU controlled system	<ul style="list-style-type: none"> <li>• Replace the fuse</li> <li>• Get the vehicle checked and rectified at Authorised workshop</li> </ul>
4.	<b>Engine overheats</b>	Coolant level low, coolant leakages Hose collapsed/torn Low engine oil level Cap not sealing properly A.C. condenser fan not working Brakes binding Electric fan not working	<ul style="list-style-type: none"> <li>• Check and correct leakages Top up coolant</li> <li>• Get the hose replaced</li> <li>• Add oil</li> <li>• Fit the auxiliary water tank cap correctly</li> <li>• Get defect rectified</li> <li>• Get defect rectified</li> <li>• Get defect rectified</li> </ul>

## EMERGENCY SERVICE TIPS - Engine (Diesel)

SR. NO.	PROBLEM OBSERVED	PROBABLE CAUSE	ACTION TO BE TAKEN
		High delivery pressure in A.C. refrigerant circuit	<ul style="list-style-type: none"> <li>• Get defect rectified</li> </ul>
		Radiator fins clogged	<ul style="list-style-type: none"> <li>• Clean it</li> </ul>
		Radiator water passage clogged	<ul style="list-style-type: none"> <li>• Get it rectified</li> </ul>
		Thermostat defective	<ul style="list-style-type: none"> <li>• Get it rectified</li> </ul>
5.	<b>Charging indicator continuously remains ON</b>	Battery not getting charged due to loose belt	<ul style="list-style-type: none"> <li>• Get the belt tension adjusted</li> <li>• Replace if broken</li> </ul>
6.	<b>Poor pickup</b>	Accelerator cable loose	<ul style="list-style-type: none"> <li>• Get it adjusted correctly</li> </ul>
		Air in the fuel system	<ul style="list-style-type: none"> <li>• Remove the air</li> </ul>
		Clogged fuel filter	<ul style="list-style-type: none"> <li>• Clean / Replace the element</li> </ul>
		Clogged air filter	<ul style="list-style-type: none"> <li>• Clean / Replace the element</li> </ul>
		Clutch slipping/out of adjustment	<ul style="list-style-type: none"> <li>• Get it rectified</li> </ul>
		Brakes grabbing	<ul style="list-style-type: none"> <li>• Get it rectified</li> </ul>
7.	<b>Does not accelerate</b>	Accelerator cable broken	<ul style="list-style-type: none"> <li>• Get cable replaced</li> </ul>
		Fuel filter choked	<ul style="list-style-type: none"> <li>• Replace</li> </ul>
8.	<b>Belt squeal</b>	Loose belt	<ul style="list-style-type: none"> <li>• Get belt tension adjusted</li> </ul>
		Belt glazed	<ul style="list-style-type: none"> <li>• Get belt replaced</li> </ul>
9.	<b>Low engine oil pressure indicator 'ON' when engine is running eventhough engine oil level is within MAX/MIN marking</b>	Pressure transducer faulty, and/or oil pump faulty	<ul style="list-style-type: none"> <li>• Do not run the engine extensively. Take the car to the nearest Authorised Service outlet &amp; get the fault rectified</li> </ul>

# EMERGENCY SERVICE TIPS - Engine (Petrol)

SR. NO.	PROBLEM OBSERVED	PROBABLE CAUSE	ACTION TO BE TAKEN
<b>ENGINE (PETROL)</b>			
1.	<b>Engine not cranking</b>	Dead battery, loose or improper battery/electrical connections	<ul style="list-style-type: none"> <li>• Get battery checked and/or changed</li> <li>• Jump start using another battery</li> <li>• Clean &amp; tighten connections</li> </ul>
2.	<b>Engine cranks but does not start</b>	No fuel Fuel filter chocked  Engine stop solenoid fuse blown Inertia Switch tripped off	<ul style="list-style-type: none"> <li>• Get the unleaded fuel filled</li> <li>• Get the fuel filter replaced</li> <li>• Check fuse for fuel pump &amp; EMS</li> <li>• Replace the fuse</li> <li>• Reset Inertia switch</li> </ul>
3.	<b>Engine overheats</b>	Coolant level low, coolant leakages  Hose collapsed/torn Low engine oil level Cap not sealing properly  A.C. condenser fan not working Brakes binding Electric fan not working High delivery pressure in A.C. refrigerant circuit	<ul style="list-style-type: none"> <li>• Check and correct leakages Top up coolant</li> <li>• Get the hose replaced</li> <li>• Add oil</li> <li>• Fit the auxiliary water tank cap correctly</li> <li>• Get defect rectified</li> <li>• Get defect rectified</li> <li>• Get defect rectified</li> <li>• Get defect rectified</li> </ul>



## EMERGENCY SERVICE TIPS - Engine (Petrol)

SR. NO.	PROBLEM OBSERVED	PROBABLE CAUSE	ACTION TO BE TAKEN
4.	<b>Charging indicator continuously remains ON</b>	Radiator fins clogged Radiator water passage clogged Thermostat defective Battery not getting charged due to loose belt	<ul style="list-style-type: none"> <li>• Clean it</li> <li>• Get it rectified</li> <li>• Get it rectified</li> <li>• Get the belt tension adjusted Replace if broken</li> </ul>
5.	<b>Check engine/MIL lamp continues to glow, even after start</b>	Some faults are detected by the fuel injection & ignition system	<ul style="list-style-type: none"> <li>• Get the vehicle checked and rectified at Authorised Workshop</li> </ul>
6.	<b>Poor pickup</b>	Accelerator cable loose Air in the fuel system Clogged fuel filter Clogged air filter Clutch slipping/out of adjustment Brakes grabbing	<ul style="list-style-type: none"> <li>• Get it adjusted correctly</li> <li>• Remove the air</li> <li>• Clean / Replace the element</li> <li>• Clean / Replace the element</li> <li>• Get it rectified</li> <li>• Get it rectified</li> </ul>
7.	<b>Does not accelerate</b>	Accelerator cable broken Fuel filter choked	<ul style="list-style-type: none"> <li>• Get cable replaced</li> <li>• Replace</li> </ul>
8.	<b>Belt squeal</b>	Loose belt Belt glazed	<ul style="list-style-type: none"> <li>• Get belt tension adjusted</li> <li>• Get belt replaced</li> </ul>
9.	<b>Low engine oil pressure indicator 'ON' when engine is running even though engine oil level is within MAX/MIN marking</b>	Pressure transducer faulty, and/or oil pump faulty	<ul style="list-style-type: none"> <li>• Do not run the engine extensively. Take the car to the nearest Authorised Service outlet &amp; get the fault rectified</li> </ul>

## EMERGENCY SERVICE TIPS - Clutch & Transaxle

SR. NO.	PROBLEM OBSERVED	PROBABLE CAUSE	ACTION TO BE TAKEN
<b>CLUTCH</b>			
1.	<b>Clutch slipping</b>	Improper pedal travel Rusted clutch cable Oil on clutch disc	<ul style="list-style-type: none"> <li>• Adjust pedal travel</li> <li>• Replace cable</li> <li>• Clean or replace disc at Authorised Service outlet</li> </ul>
2.	<b>Noisy clutch</b>	Pressure plate & diaphragm spring rattling  Release bearing broken/worn out Broken damper spring of clutch disc	<ul style="list-style-type: none"> <li>• Get car attended to by Authorised Service outlet</li> <li>• Replace</li> <li>• Replace</li> </ul>
<b>TRANSAXLE</b>			
1.	<b>Gears slipping out of mesh</b>	Worn/damaged grooves on shifter shaft Worn shift fork or synchroniser sleeve Weak or damaged detent springs Worn bearings on input shaft or layshaft Worn dog teeth on sleeve and gear	<ul style="list-style-type: none"> <li>• Replace</li> <li>• Replace</li> <li>• Replace</li> <li>• Replace</li> <li>• Replace sleeve and gear</li> </ul>
2.	<b>Hard shifting</b>	Inadequate lubricant Inadequate clutch pedal travel Distorted or broken clutch disc	<ul style="list-style-type: none"> <li>• Replenish</li> <li>• Adjust</li> <li>• Replace</li> </ul>

## EMERGENCY SERVICE TIPS - Brakes

SR. NO.	PROBLEM OBSERVED	PROBABLE CAUSE	ACTION TO BE TAKEN
3.	<b>Noise</b>	Damaged clutch pressure plate Worn synchrocones Worn dog teeth on sleeve or gear Distorted shift shaft/linkages Inadequate or insufficient lubricant Damaged or worn bearing(s) Damaged or worn gear(s) Damaged or worn synchroniser parts	<ul style="list-style-type: none"> <li>• Replace clutch cover/disc</li> <li>• Replace</li> <li>• Replace sleeve or gear</li> <li>• Replace</li> <li>• Replenish</li> <li>• Replace</li> <li>• Replace</li> <li>• Replace</li> </ul>
<b>BRAKES</b>			
1.	<b>Poor brakes</b>	Insufficient brake fluid Air in the system Pedal travel excessive due to excessive shoe gap Vacuum leakage Brake oil (line) leaking Oil on the drum/liners  Worn brake lining Defective/worn parts	<ul style="list-style-type: none"> <li>• Get the brake fluid filled</li> <li>• Get the air removed</li> <li>• Rectify automatic adjuster</li>   <li>• Rectify the leakage</li> <li>• Replace the leaking line</li> <li>• Get the liners cleaned/replace seals if leaking</li> <li>• Get the liners replaced</li> <li>• Get them replaced</li> </ul>
2.	<b>Brake pulling to one side</b>	Oil on the brake lining One side shoe/pad worn Loose brake anchor plate	<ul style="list-style-type: none"> <li>• Clean the brake lining</li> <li>• Get the shoe/pad replaced</li> <li>• Tighten the bolts</li> </ul>

## EMERGENCY SERVICE TIPS - Steering

SR. NO.	PROBLEM OBSERVED	PROBABLE CAUSE	ACTION TO BE TAKEN
3.	<b>Brake Squeal</b>	One side brake pipe clogged Defective tandem master cylinder  Defective brake lining Glazed lining Loose rivets. Wrong lining Shoe return spring broken Front pads rubbing on the disc	<ul style="list-style-type: none"> <li>• Get the brake line cleaned</li> <li>• Rectify/Replace tandem master cylinder</li> <li>• Replace</li> <li>• Clean or replace lining</li> <li>• Install rivets properly</li> <li>• Install correct lining</li> <li>• Replace</li> <li>• Get it corrected</li> </ul>
<b>STEERING SYSTEM</b>			
1.	<b>Hard steering (For power steering)</b>	Less fluid in the power steering tank Air in the system  Loose pump belt	<ul style="list-style-type: none"> <li>• Get the fluid topped up to the correct level</li> <li>• Get the air removed by bleeding the system</li> <li>• Get the belt correctly adjusted</li> </ul>
2.	<b>Poor Returnability</b>	Low tyre pressure Grabbing of linkages Steering gear disturbed	<ul style="list-style-type: none"> <li>• Adjust to correct value</li> <li>• Check &amp; rectify</li> <li>• Check &amp; adjust</li> </ul>
3.	<b>Excessive play on steering</b>	Rack & pinion attachment loose	<ul style="list-style-type: none"> <li>• Get it tightened</li> </ul>

## EMERGENCY SERVICE TIPS - Electrical & Suspension

SR. NO.	PROBLEM OBSERVED	PROBABLE CAUSE	ACTION TO BE TAKEN
<b>ELECTRICAL</b>			
1.	<b>Battery charge &amp; engine oil pressure lamp in cluster not operating when key is in 'IGN' position</b>	Battery terminal loose or disconnected Battery completely dead Bulb fused Fuse blown Loose/open connections	<ul style="list-style-type: none"> <li>• Check connections</li> <li>• Get the battery properly connected</li> <li>• Get the battery charged</li> <li>• Get the alternator &amp; charging circuit checked</li> <li>• Get the bulb checked</li> </ul>
2.	<b>Non functioning Electrical accessories such as power windows, head lamps, fuel &amp; temp. gauge, RPM meter, wiper &amp; washer unit and all lamps etc.</b>	Fuse blown in the circuit Loose connectors.  Circuit relay/controllers loose in the base Defective components	<ul style="list-style-type: none"> <li>• Replace the fuse if blown</li> <li>• Get the connection properly tightened/fixd</li> <li>• Fix the relay firmly</li> <li>• Get the defective components replaced at an Authorised Service outlet</li> </ul>
<b>SUSPENSION</b>			
1.	<b>Abnormal or excessive tyre wear</b>	Tyre out of balance  Steering geometry disturbed Tyres not adequately inflated	<ul style="list-style-type: none"> <li>• Check balance and/or adjust if required</li> <li>• Adjust steering geometry</li> <li>• Adjust tyre pressure</li> </ul>

## EMERGENCY SERVICE TIPS - Suspension

SR. NO.	PROBLEM OBSERVED	PROBABLE CAUSE	ACTION TO BE TAKEN
2.	<b>Abnormal noise from front end</b>	Wobbly wheel or tyre Defective tyre Hub play not proper Brake grabbing Excessive braking Worn, sticky or loose tie rod ends, lower ball joints, tie rod in side ball joints or drive shaft joints Warning noise for pad wear Damaged struts or mounting Worn suspension arm bushings Loose wheel nuts Loose suspension bolts or nuts Broken or damaged wheel bearing Poorly lubricated or worn strut bearings Excessive hub play Loose caliper housing bolts	<ul style="list-style-type: none"> <li>• Replace wheel or tyre</li> <li>• Replace tyre</li> <li>• Adjust hub play</li> <li>• Check and rectify</li> <li>• Modify driving habit</li> <li>• Replace tie rod end, suspension arm, tie rod or drive shaft joints</li> <li>• Replace pad</li> <li>• Repair mounting or replace struts</li> <li>• Replace</li> <li>• Tighten wheel nuts</li> <li>• Tighten suspension bolts or nuts</li> <li>• Replace</li> <li>• Lubricate or replace strut bearings</li> <li>• Adjust</li> <li>• Check &amp; tighten</li> </ul>
3.	<b>Ride too soft / bumpy</b>	Faulty struts	<ul style="list-style-type: none"> <li>• Replace strut</li> </ul>
4.	<b>Suspension bottoms</b>	Over loaded Faulty struts	<ul style="list-style-type: none"> <li>• Check loading</li> <li>• Replace struts</li> </ul>

### ■ IMPORTANT INFORMATION

- Chassis & Aggregate Numbers
- Fuel, Coolants & Lubricants
- Technical Specifications
- Service Schedule
- Car Record Sheet

# IMPORTANT INFORMATION - Chassis & Aggregate Numbering

## LOCATION OF CHASSIS AND AGGREGATE NUMBERS (DIESEL)



Engine Number (Common Rail)

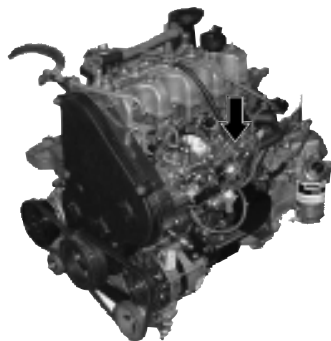

Engine Number ( TCIC )

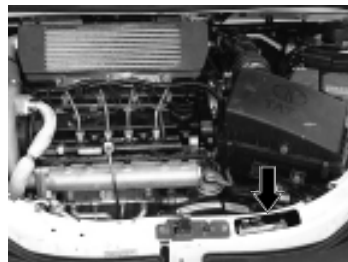

Chassis Number Plate  
(Common Rail)



Chassis Number Plate (TCIC)

Transaxle Number

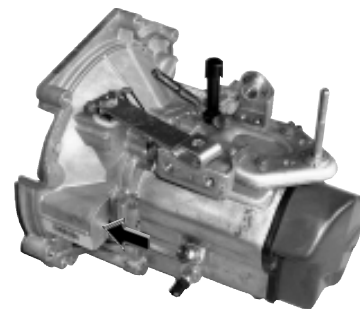



# IMPORTANT INFORMATION - Chassis & Aggregate Numbering

## LOCATION OF CHASSIS AND AGGREGATE NUMBERS (PETROL)

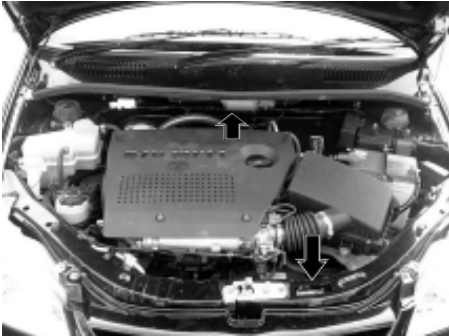

**Chassis Number Plate**



**Engine Number**

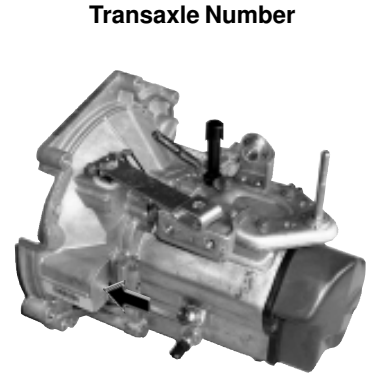

**Transaxle Number**

## IMPORTANT INFORMATION - Fuel, Lubricants & Coolant

### FUEL (DIESEL) :

**Fuel BS-III** : High speed diesel conforming to IS 1460 or DIN 51601 or equivalent is recommended to be used as fuel.

**Fuel BS-IV** : Normal grade BS IV compliant diesel conforming to IS1460 or EN 590 or equivalent is recommended to be used as fuel. It is always recommended to use BS IV Compliant fuel to get optimum emission performance.

Do not use premium diesels available in the market **for example extra premium / Turbojet etc.**

### Recommended Fuel Specification.

	Parameter	Unit	BS III	BS IV
1	Cetane Number (min)	CN	51	51
2	Sulphur content	mg/kg	350	50
3	Lubricity (HFRR)	micon	460	460

### NOTICE

Where oxidation catalytic converter is fitted, it is mandatory to use Diesel fuel with sulphur contents as given above. Use of any other diesel fuel can increase the pollutants.

At very low temperature, fluidity of diesel may become insufficient due to paraffin separation. It is therefore necessary to mix supplementary fuel with summer or winter grade diesel. The supplementary fuel to be used is kerosene or aviation turbine fuel. Ratio for mixing of supplementary fuel and diesel are shown in the table.

Ambient Temperature upto Deg. C	Percentage	
	Summer grade diesel	Supplementary fuel
Upto 0	100	0
0 to -10	70	30
-10 to -15	50	50

Care should be taken that diesel and supplementary fuel are thoroughly mixed before filling.

Ambient temperature upto Deg. C	Percentage	
	Winter grade diesel	Supplementary fuel
Upto -15	100	0
-15 to -20	70	30
-20 and below	50	50

**WARNING:** Do not mix gasoline or alcohol with diesel. This mixture can cause explosion.

# IMPORTANT INFORMATION - Fuel, Lubricants & Coolant

## FUEL (PETROL) :

**Fuel BS-III** : Unleaded regular grade petrol conforming to IS 2796 DIN 51607 (or equivalent) and octane rating not less than 87 RON (RON stands for Research Octane Number) is recommended to be used as fuel.

**Fuel BS-IV** : Unleaded regular grade BS IV compliant petrol conforming to IS2796-1994/DIN 51607 (or equivalent) and RON not less than 91 is recommended to be used as fuel. It is always recommended to use BS IV Compliant petrol to get optimum emission performance.

### CAUTION

Always use proper fuel of recommended specifications

## Lubricants : (Diesel)

**Engine Oil** : Recommended grade of engine oil conforming to API CF4+ specification and range of ambient temperature at which these can be used are given in the table below.

Ambient temp. in deg. C	Engine oil grade
-10 deg. & above	SAE 15W/40 or SAE 15W/50
-20 deg. to 30 deg.	SAE 10W/30
Below -10 deg.	SAE 5W/20 or SAE 5w/30

## Lubricants : (Petrol)

**Engine oil** : Recommended grade of engine oil conforming to API-SF/CC specification and range of ambient temperature at which these can be used are given in the table below.

Ambient temp. in deg. C	Engine oil grade
-10 deg. & above	SAE 20W/40 or SAE 20W/50
-15 deg. to 40 deg.	SAE 15W/40 or SAE 15W/50
-20 deg. to 40 deg.	SAE 10W/40 or SAE 10W/50
-35 deg. to 40 deg.	SAE 5W/30

## Transaxle :

Use recommended brand of EP 80 gear oil.

## Grease for axle bearings :

Lithium base complex grease

## Brake fluid :

IS 8654/DOT 3

## Power Steering :

ATF A DEXRON III

## **IMPORTANT INFORMATION - Fuel, Lubricants & Coolant**

---

### **Coolants :**

Presence of dirt in the coolant chokes up passages in the radiator, cylinder head and cylinder block, thereby causing insufficient cooling of engine.

To prevent rust formation and freezing of coolant inside the passages of radiator, cylinder block and cylinder head, use only branded premixed engine coolant.

## IMPORTANT INFORMATION - Co-branded Lubricants & Coolant

PLEASE USE ONLY GENUINE ENGINE OILS, COOLANTS, LUBRICANTS, BRANDED BY  
**TATA MOTORS** FOR OPTIMUM PERFORMANCE OF YOUR **TATA INDIGO...**

ITEM	COMPANY	BRAND	QTY
ENGINE OIL (DIESEL)	CASTROL HPCL	Castrol GTD 15 W/40 HP Milcy 15 W/40	5.5 Litres
ENGINE OIL (PETROL)	CASTROL HPCL	Castrol GTX 20 W/40 HP ESMO 20 W/40	4.0 Litres
COOLANT	SUNSTAR ANCHEMCO HPCL	Golden Cruiser 1400 M Frostox SFD 12 HP Thanda Raja P	6 Litres
TRANSMISSION OIL	HPCL CASTROL	Gear Oil EP 80 Castrol Extreme Pressure 80 EP	3.3 Litres
STEERING OIL	HPCL CASTROL EXXON	HP ATF DEX III CASTROL-TQ DEX III EXXON- Multipurpose ATF	1.2 Litres
BRAKE FLUID	HPCL CASTROL	Super Duty Brake Fluid DOT-3 Castrol Universal Brake Fluid DOT-3	0.270 Litres
HUB GREASE	CASTROL	Castrol Grease AP2	

# IMPORTANT INFORMATION -Technical Specification

---

## 1. ENGINE (DIESEL) :

<b>Model</b>	: Tata 475 IDI <b>TCIC</b> : Tata 1.4L <b>COMMON RAIL</b>
<b>Type</b>	: Water cooled, Diesel Engine with Turbo-charger, EGR system & oxydation catalyst with Turbo Charger & Intercooler
<b>No of cylinders</b>	: 4 inline
<b>Bore/Stroke</b>	: 75 mm x 79.5 mm ( <b>TCIC</b> ) : 75 mm x 79 mm ( <b>COMMON RAIL</b> )
<b>Capacity</b>	: 1405 cc ( <b>TCIC</b> ) : 1396 cc ( <b>COMMON RAIL</b> )
<b>Max. engine output</b>	: 70 PS at 4500 rpm ( <b>TCIC</b> ) 70 Ps at 4000 rpm ( <b>COM. RAIL</b> )
<b>Max. Torque</b>	: 135 Nm at 2500 rpm ( <b>TCIC</b> ) 140 Nm at 1400-2750 rpm ( <b>COMMON RAIL</b> )
<b>Compression ratio</b>	: 21:1 ( <b>TCIC</b> ) : 18.5:1 ( <b>BS-III</b> ) /17.5:1( <b>BS-IV</b> ) ( <b>COMMON RAIL</b> )
<b>Firing order</b>	: 1-3-4-2

## 1.ENGINE (PETROL)

<b>Model</b>	: Tata 475 SI ( <b>MPFI</b> ) - (1.4L) <b>BS - III</b> : Tata 475 SI ( <b>MPFI</b> ) - (1.2L) <b>BS - III</b> : Tata 475 SI 56 ( <b>MPFI</b> )- (1.2L) <b>BS- IV</b>
<b>Type</b>	: Water cooled, (Multi Point Fuel Injection) Petrol Engine
<b>No of cylinders</b>	: 4 inline
<b>Bore/Stroke</b>	: 75 mm x 79.5 mm ( <b>1.4L</b> )- <b>BS-III</b> 75mm x 67.5mm ( <b>1.2L</b> )- <b>BS-III/IV</b>
<b>Capacity</b>	: 1405 cc ( <b>1.4L</b> )- <b>BS-III</b> 1193 cc ( <b>1.2L</b> )- <b>BS-III/IV</b>
<b>Max. engine output</b>	: 85 PS at 5500 rpm ( <b>1.4L</b> )- <b>BS-III</b> 65 PS at 5200 rpm ( <b>1.2L</b> )- <b>BS-III</b> 65 PS at 5000 rpm ( <b>1.2L</b> )- <b>BS-IV</b> as per ISO-14599
<b>Max. Torque</b>	: 120 Nm at 3500 rpm ( <b>1.4L</b> )- <b>BS-III</b> 102 Nm at 2600 rpm ( <b>1.2L</b> )- <b>BS-III</b> 100 Nm at 2700 rpm ( <b>1.2L</b> )- <b>BS-IV</b> as per ISO-14599
<b>Compression ratio</b>	: 10 : 1
<b>Firing order</b>	: 1-3-4-2

# IMPORTANT INFORMATION -Technical Specification

## 2. CLUTCH

Type : Single plate dry friction diaphragm type

Outside diameter: 200 mm (DIESEL) /  
of clutch lining 190 mm (PETROL)

Friction area : 289 sq.cm.(DIESEL) /  
285 sq.cm.(PETROL)

## 3. TRANSAXLE

: Front wheel drive through constant velocity joints.

Model : TA65-5 / 3.64 with overdrive

Type : Synchromesh on all forward gears. Sliding mesh for reverse gear.

No. of gears : 5 Forward, 1 Reverse

		TCIC	COMMON	PETROL
			RAIL	

Gear ratios	:	1st	-	3.64	3.64	3.42
		2nd	-	1.95	1.95	1.95
		3rd	-	1.13	1.27	1.36
		4th	-	0.78	0.88	0.95
		5th	-	0.64	0.674	0.71
		Rev.	-	3.58	3.58	3.58
Final drive ratio	:			4.4	3.765	4.64

## Gear Shift

Floor mounted with International "H" pattern, with Fifth and Reverse inline. with interlock to prevent accidental engagement from 5th to reverse

## 4. REAR AXLE

: Non driven axle Independently suspended

## 5. SUSPENSION

### Front

: Independent, Lower wishbone, McPherson Strut type.

### Rear

: Independent 3 link & Mc Pherson strut type

### Antiroll bar

: At front & rear

## 6. STEERING

### Standard

: Manual rack and pinion steering gear with collapsible steering column ( Indigo CS LE/GLE)

: Hydraulic Power assisted Rack & Pinion Steering Gear with collapsible steering column

### Steering Wheel

: 380 mm dia  
360 mm dia ( Indigo CS LS/GLS)

# IMPORTANT INFORMATION -Technical Specification

---

## 7. BRAKES

- Service brakes : Dual circuit, diagonal split hydraulic brakes through tandem master cylinder.
- Front : 231 mm dia disc brake
- Rear : 200 mm dia drum brake
- Parking brake : Lever type, Console mounted, Cable operated mechanical linkages acting on rear wheels

## 8. WHEELS & TYRES

- Tyres : 175/65R 14 (All Models)  
165/65R 14 Indigo CS LE/GLE/TCIC
- Wheel rims : 5 J x 14 stylised steel rims  
For SX/ GSX : 5J X 14 Stylised Alloy rims
- No. of wheels : Front - 2 , Rear - 2, Spare - 1

9. FUEL TANK : Capacity :42 litres

10. BODY : 3 Box steel monocoque body

## 11. ELECTRICAL SYSTEM

- System Voltage : 12 Volts -ve earth
- Battery : 12V, MF 55 DIN (DIESEL)  
12V, MF 44 DIN (PETROL)
- Alternator : 12V 90A

## 12. PERFORMANCE (kmph)

Max. speed at : 160 (DIESEL) / 140 (PETROL)  
rated GVW

## 13. MAIN CHASSIS DIMENSIONS AS PER ISO:612 IN MM

- Wheel base : 2450
- Track front : 1380
- Track rear : 1360
- Front Overhang : 810 (Indigo)  
: 800 (Indigo CS)
- Rear Overhang : 917 (Indigo)  
: 738 (Indigo CS)
- Overall length : 4177 (Indigo)  
: 3988 (Indigo CS)
- Max. Width :
- Over body : 1620
- Over outer rear view mirrors  
in folded condition : 1745
- Overall height - unladen : 1540
- Min. turning circle dia : 10 m
- Min. turning clearance circle dia : 10.65 m
- Ground clearance - unladen : 165



## IMPORTANT INFORMATION -Technical Specification

### 14. WEIGHT (kg) (TOLERANCE AS PER EEC 92/21)

	INDIGO			INDIGO CS		
	GLS / LS	GLX / LX	GSX / SX	GLS / LS	GLE / LE	GLX
Complete car kerb weight as per ISO:1176 ( with spare wheel & tools)	1085 (MPFI)	1090 (MPFI)	1115 (MPFI)	1060 (MPFI)	1065 (MPFI)	1070 (MPFI)
	1110 (TCIC)	1115 (TCIC)	1140 (TCIC)	1090 (TCIC)	1085 (TCIC)	---
	1150 (CR*)	1155 (CR*)	1180 (CR*)	1105 (CR*)	1105 (CR*)	1110 (CR*)
Gross Vehicle Weight	1510 (MPFI)	1510 (MPFI)	1510 (MPFI)	1510 (MPFI)	1510 (MPFI)	1510 (MPFI)
	1515 (TCIC)	1515 (TCIC)	1515 (TCIC)	1515 (TCIC)	1515 (TCIC)	---
	1565 (CR*)	1565 (CR*)	1565 (CR*)	1540 (CR*)	--	1540 (MPFI)
Payload	425 (MPFI)	420 (MPFI)	395 (MPFI)	450 (MPFI)	445 (MPFI)	440 (MPFI)
	405 (TCIC)	400 ( TCIC)	375 (TCIC)	425 (TCIC)	430 (TCIC)	---
	415 (CR)(CR*)	410 (CR*)	385 (CR*)	435 (CR*)	---	430 (MPFI)

\* **Common Rail**

--

**15. PASSENGER CAPACITY** : 2 front + 3 rear

### 16. LUGGAGE SPACE

Net inside loading space : 0.45 m<sup>3</sup> (Indigo)  
 : 380 Litres (Indigo CS)

## IMPORTANT INFORMATION -Service Schedule

---

### SERVICE INSTRUCTIONS :

To achieve economical and trouble free performance, please follow the instructions as stated.

**YOUR CAR IS ENTITLED TO FOUR FREE SERVICES (LABOUR ONLY). THE FREE SERVICE COUPONS ARE ATTACHED TO THE SALES INVOICE. PLEASE PRESENT THESE COUPONS TO THE SERVICING DEALER WHILE AVAILING FREE SERVICES.**

- 1<sup>st</sup> free service** - At 1000-1500 km. OR 1 month whichever is earlier
- 2<sup>nd</sup> free service** - At 5000-5500 km. OR 6 months whichever is earlier
- 3<sup>rd</sup> free service** - At 10000-10500 km. OR 12 months whichever is earlier
- 4<sup>th</sup> free service** - At 20000-20500 km. OR 24 months whichever is earlier

All services other than free services are chargeable.

Servicing of the car can be done at any **TATA MOTORS** Authorised Dealer Workshop, **TATA MOTORS** Authorised Service Centre (TASC) or **TATA MOTORS** Authorised Service Point (TASP). The details of their locations are given in this manual.

Warranty claims can be settled by any Tata Motors Authorised Dealer for all failures, while all warranty claims excluding the consideration on the replacement of major aggregates, can be settled by any TASC which is authorised for handling warranty claims. TASPs will not handle warranty repairs.

## IMPORTANT INFORMATION -Service Schedule

	OPERATION	FREQUENCY	PDI	1,000 - 1,500	5,000 - 5,500	10,000-10,500	20,000-20,500	30,000-30,500	40,000-40,500	50,000-50,500	60,000-60,500	70,000-70,500	80,000-80,500	90,000-90,500	100,000-100,500
1	Wash the vehicle & Clean Condenser Fins	EVERY Service	•	•	•	•	•	•	•	•	•	•	•	•	•
2	Drain water accumulated in Sedimenter / when warning lamp glows <b>(COMMON RAIL)</b> Drain water from Fuel Filter Bowl <b>(For Diesel Engines)</b>	EVERY Service	•	•	•	•	•	•	•	•	•	•	•	•	•
3	Check & Top up Fluids (If required): Transaxle Oil, Coolant, Brake Fluid, Battery Electrolyte, Wind Screen washer fluid, Power Steering Oil (If fitted).	EVERY Service	•	•	•	•	•	•	•	•	•	•	•	•	•
4	Check Fuel Lines for Leakages.	10,000				•	•	•	•	•	•	•	•	•	•
5	Check Rubber Boots & Bushes for damage.	30,000						•			•			•	
	<b>DIESEL / MPFI / COMMON RAIL ENGINE</b>														
1	Clean air filter element (more frequently for vehicle operating as TAXI)	10,000			•	•	•	•	•	•	•	•	•	•	•
2	Change engine oil and Oil filter Or 12 Months whichever is earlier	10,000				•	•	•	•	•	•	•	•	•	•
3	Change fuel filter <b>(MPFI)</b> / fuel filter element <b>(Diesel)</b> Change fuel filter <b>(COMMON RAIL)</b>	10,000 30,000				•	•	•	•	•	•	•	•	•	•
4	Check all Drive belts for tension, adjust if necessary	10,000				•	•	•	•	•	•	•	•	•	•
5	Check timing belt, adjust tension if necessary, replace if defective <b>(Diesel / MPFI)</b>	20,000					•		•		•		•		•
6	Replace air filter element (more frequently for vehicle operating as TAXI)	40,000							•				•		
7	Change coolant (or two years whichever is earlier)	40,000							•				•		
8	Replace timing belt	100,000													•
9	Replace Spark Plugs <b>(MPFI)</b>	30,000						•			•			•	
10	Replace Sedimenter <b>(COMMON RAIL)</b>	100,000													•

## IMPORTANT INFORMATION -Service Schedule

	OPERATION	FREQUENCY	PDI	1,000 - 1,500	5,000 - 5,500	10,000 - 10,500	20,000 - 20,500	30,000 - 30,500	40,000 - 40,500	50,000 - 50,500	60,000 - 60,500	70,000 - 70,500	80,000 - 80,500	90,000 - 90,500	100,000 - 100,500
	<b>TRANSAXLE</b>														
1	Change Transaxle oil	20,000					•	•	•	•	•	•	•	•	•
	<b>BRAKES</b>														
1	Check front brake pads & rear brake linings. Replace if necessary	20,000					•	•	•	•	•	•	•	•	•
2	Repalce brake fluid (or 2 years whichever is earlier) & Check brake system components for Leakages	40,000						•					•		
	<b>WHEELS &amp; TYRES</b>														
1	Rotate tyres	20,000					•	•	•	•	•	•	•	•	•
	<b>FRONT &amp; REAR SUSPENSION</b>														
1	Check & Adjust Wheel alignment	20,000					•	•	•	•	•	•	•	•	•
	<b>STEERING</b>														
1	Replace power steering oil	80,000											•		
	<b>ELECTRICAL</b>														
1	Check specific gravity of battery electrolyte (OR Every 6 Months)	10,000				•	•	•	•	•	•	•	•	•	•
2	Check headlamp focussing	30,000						•			•			•	
	<b>A.C. SYSTEM</b>														
1	Check Airconditioning / HVAC System for satisfactory performance	EVERY Service	•	•	•	•	•	•	•	•	•	•	•	•	•





## IMPORTANT INFORMATION - Record Service Performed

Recommended Service	Date	Odometer reading km.	Repair Order No.	Servicing Dealer's Signature & Stamp
At km.				
<b>PDI Free Labour</b>				
1,000 *				
10,000 *				
20,000 *				
30,000 #				
40,000 #				
50,000 #				
60,000 #				
70,000 #				
80,000 #				
90,000 #				
1,00,000 #				
1,10,000 #				

Recommended Service	Date	Odometer reading km.	Repair Order No.	Servicing Dealer's Signature & Stamp
At km.				
1,20,000 #				
1,30,000 #				
1,40,000 #				
1,50,000 #				
1,60,000 #				
1,70,000 #				
1,80,000 #				
1,90,000 #				
2,00,000 #				

\* Labour free, material chargeable

# Change engine oil and oil filter

## IMPORTANT INFORMATION - Record of Warranty Repairs Carried Out

Date	Odometer reading (km)	Repair Order No.	Particulars of Repair	Servicing Dealer's Signature & Stamp



## IMPORTANT INFORMATION - Record of Warranty Repairs Carried Out

Date	Odometer reading (km)	Repair Order No.	Particulars of Repair	Servicing Dealer's Signature & Stamp

## IMPORTANT INFORMATION - ABBREVIATIONS

---

<b>AC</b>	Air Conditioning	<b>MD</b>	Main Dealer
<b>ACC</b>	Accessories	<b>Min</b>	Minimum
<b>Amp</b>	Ampere	<b>mkg</b>	Meter per Kilogram
<b>Br</b>	Branch	<b>mm</b>	Millimeter
<b>Brg</b>	Bearing	<b>Mtg</b>	Mounting
<b>cc</b>	Cubic Centimeters	<b>No</b>	Number
<b>Cm</b>	Centimeter	<b>PCBU</b>	Passenger Car Business Unit
<b>Dia</b>	Diagonal	<b>PDI</b>	Pre-delivery Inspection
<b>EGR</b>	Exhaust Gas Recirculation	<b>PSI</b>	Pounds per Square Inch
<b>FAW</b>	Front Axle Weight	<b>PUC</b>	Pollution Under Control
<b>Fig</b>	Figure	<b>RAW</b>	Rear Axle Weight
<b>FIP</b>	Fuel Injection Pump	<b>RCSM</b>	Regional Customer Support Manager
<b>gm</b>	Gram	<b>RH</b>	Right Hand
<b>GVW</b>	Gross Vehicle Weight	<b>RM</b>	Regional Manager
<b>IGN</b>	Ignition	<b>RPM</b>	Revolution Per Minute
<b>Kg</b>	Kilogram	<b>Sec</b>	Seconds
<b>Km</b>	Kilometer	<b>Sq.cm.</b>	Square Centimeter
<b>Km/h</b>	Kilometer per hour	<b>TASC</b>	Tata Motors Authorised Service Centre
<b>LH</b>	Left Hand	<b>TASP</b>	Tata Motors Authorised Service Point
<b>Max</b>	Maximum	<b>V</b>	Volts
		<b>W</b>	Watts
		<b>Wt</b>	Weight





**TATA MOTORS**

*Rely on us... always.*

Call Us : **1 800 209 7979**

Mail Us : [customercare@tatamotors.com](mailto:customercare@tatamotors.com)

Visit Us: [www.customercare.tatamotors.com](http://www.customercare.tatamotors.com)

2889 5840 99 01

Designed & Developed by : LDC, Customer Support, PCBU, Pune