

INSPECTION AND MAINTENANCE

Periodic Maintenance Schedule.....	9-1
Drive Belt.....	9-6
Engine Oil and Filter.....	9-7
Gear Oil.....	9-10
Engine Coolant.....	9-12
Windscreen Washer Fluid.....	9-14
Air Cleaner.....	9-14
SparkPlugs.....	9-15
Brakes.....	9-16
Steering.....	9-18
Clutch Pedal.....	9-18
Tyres.....	9-19
Battery.....	9-22
Fuses.....	9-22
Bulb Replacement.....	9-25
Wiper Blades.....	9-28



76G-0M01

▲ WARNING

You should take extreme care when working on your vehicle to prevent accidental injury. Here are a few precautions that you should be especially careful to observe:

- Do not leave the engine running in garages or other confined areas.
- When the engine is running, keep hands, clothing, tools, and other objects away from the fan and water pump belt. Even though the fan may not be moving, it can automatically turn on without warning.

C=>

▲ WARNING

- When it is necessary to do service work with the engine running, make sure that the parking brake is applied fully and the transmission is in Neutral (for manual transmission vehicles).
- Do not touch ignition wires or other ignition system parts when starting the engine or when the engine is running, or you could receive an electric shock.
- Be careful not to touch a hot engine, exhaust manifold and pipes, muffler, radiator and water hoses.
- Do not allow smoking, sparks, or flames around gasoline or the battery. Flammable fumes are present.
- Do not get under your vehicle if it is supported only with the portable jack provided in your vehicle.
- Be careful not to cause accidental short circuits between the positive and negative battery terminals.
- Keep used oil, coolant, and other fluids away from children and pets. Dispose of used fluids properly; never pour them on the ground, into sewers, etc.

PERIODIC MAINTENANCE SCHEDULE

The following table shows when regular maintenance on your vehicle is required. This table shows in kilometres and months when inspections, adjustments, lubrication and other services should be performed.

▲ WARNING

Maruti recommends that maintenance on your Maruti vehicle be performed by Maruti Authorised Dealer/Service Station.

▲ CAUTION

Whenever it becomes necessary to replace parts on your vehicle, it is recommended that you use MARUTI GENUINE PARTS (MGP).

A....Adjust.

T....Tighten to specified torque.

R....Replace or change.

L....Lubricate.

I....Inspect and correct or replace if necessary.

C....Clean.

O....Rotate

Note:

This table includes services as scheduled up to 80,000 km mileage. Beyond 80,000 km, carry out the same services at the same intervals respectively.

Interval: This interval should be judged by odometer reading or months, whichever comes first.	km (x 1,000) months	FREE INSPECTIONS			PERIODIC MAINTENANCE SERVICE AT COST						
		1	5	10	20	30	40	50	60	70	80
		1	6	12	24	36	48	60	72	84	96
ENGINE											
1. Water pump drive belt (tension, wear)		A	I	I	I	I	I	I	R	A	I
2. Engine coolant (level, leakage)		I	I	I	R	I	R	I	R	I	R
3. Engine oil (API GRADE SF, SG, SH) & Oil filter		R	I	R	R	R	R	R	R	R	R
4. Cooling system hoses and connections (leakage, damage)		I	I	I	I	I	I	I	I	I	I
5. Engine bolts (All cylinder head and manifold fixings)		-	-	T	-	T	-	T	-	T	-
6. Engine mounting (loose, damage)		-	-	T	-	T	-	T	-	T	-
7. Valve clearance		-	A	-	A	-	A	-	A	-	A
8. Camshaft timing belt (damage, wear)		-	-	-	I	-	I	-	I	-	I
		Replace every 1,00,000 km									
9. Exhaust system (noise, leakage or otherwise defective)		-	I	-	I	-	I	-	I	-	I
10. Positive crankcase ventilation System (Hoses, connections and valve)		-	I	-	I	-	I	-	I	-	I
IGNITION											
1. Ignition wiring, (damage, deterioration)		-	-	-	I	-	I	-	I	-	I
2. Spark plugs (clean and adjust the gap)		-	-	I	R	I	R	I	R	I	R

INSPECTION AND MAINTENANCE

Interval: This interval should be judged by odometer reading or months, whichever comes first.	km (x 1,000) months	FREE INSPECTIONS			PERIODIC MAINTENANCE SERVICE AT COST							
		1	5	10	20	30	40	50	60	70	80	
		1	6	12	24	36	48	60	72	84	96	
3. Distributor cap and rotor/wear and deterioration)*	—	—	—	—	—	—	—	—	—	—	—	
FUEL												
1. Air cleaner	Paved-road Dusty condition	Clean every 5,000 km. Replace every 40,000 km. Clean every 2,500 km or as required. Replace every 40,000 km. More frequent replacement if dust condition is severe.										
2. Accelerator cable and Throttle shafts		-	I&L	I&L	I&L	I&L	I&L	I&L	I&L	I&L	I&L	
3. Fuel tank cap, fuel lines & connections(leakage,damage)		-	I	-	-	-	I	-	-	-	I	
4. Fuel filter (leakage)		I	I	I	I	I	R	I	I	I	R	
CLUTCH AND TRANSMISSION												
1. Clutch pedal (play)		I	I	I	I	I	I	I	I	I	I	
2. Clutch slipping (dragging or excessive damage)		I	I	I	I	I	I	I	I	I	I	
3. Manual Transmission/Transfer and Differential! oil (level, leakage)		I	I	I	R	I	R	I	R	I	R	
DRIVE SHAFTS												
1. Drive shafts boots (bent of boots damage)		-	I	I	I	I	I	I	I	I	I	
BRAKE												
1. Brake fluid (level, leakage)		I	I	I	R	I	R	I	R	I	R	
2. Brake pedal (pedal-to-wall clearance)		I	I	I	I	I	I	I	I	I	I	
3. Parking brake lever and cable (play, damage)		I	I	I	I	I	I	I	I	I	I	
4. a. Brake discs and pads, (wear)		-	I	I	I	I	I	I	I	I	I	
b. Brake drums & shoes		-	I	I	I	I	I	I	I	I	I	
5. Master cylinder and wheel cylinder or calliper (oil leakage, boot kit)		I	I	I	I	I	R	I	I	I	R	
6. Brake hoses and pipes (leakage, damage)		I	I	I	I	I	I	I	I	I	I	

For LX only

9-3

76G-74E

INSPECTION AND MAINTENANCE

Interval: This interval should be judged by odometer reading or months, whichever comes first.	km (x 1,000) months	FREE INSPECTIONS			PERIODIC MAINTENANCE SERVICE AT COST							
		1	5	10	20	30	40	50	60	70	80	
		1	6	12	24	36	48	60	72	84	96	
WHEEL												
1. Tyres (air pressure, abnormal wear, crack, ROTATION)		Rotate and inspect every 5,000 km										
2. Wheels (damage)		I	I	I	I	I	I	I	I	I	I	
3. Front wheel bearings (loose, damage)		-	I	I	I	I	I	I	I	I	I	
4. Rear wheel bearings (loose, damage)		-	I	I	I	I	I	I	I	I	I	
FRONT AND REAR SUSPENSION												
1. Suspension strut (oil leakage, damage)		I	I	I	I	I	I	I	I	I	I	
2. Suspension arms and knuckle supports (loose,damage)		-	I	I	I	I	I	I	I	I	I	
3. Rear spring (damage)		-	I	I	I	I	I	I	I	I	I	
4. Shock absorbers (oil leakage, damage)		I	I	I	I	I	I	I	I	I	I	
5. All bolts and nuts (loose)		-	T	T	T	T	T	T	T	T	T	
6. Suspension arms and Tension rods		-	I	I	I	I	I	I	I	I	I	
STEERING												
1. Steering wheel (play, loose)		I	I	I	I	I	I	I	I	I	I	
2. All rods and arms (loose, damage, wear)		I	I	I	I	I	I	I	I	I	I	
ELECTRICAL												
1. Battery electrolyte (level, leakage)		I	I	I	I	I	I	I	I	I	I	
2. Wiring harness connection (looseness, damage)		-	I	I	I	I	I	I	I	I	I	
3. Lighting system (operation, stains, damage)		I	I	I	I	I	I	I	I	I	I	
4. Horn (operation)		I	I	I	I	I	I	I	I	I	I	
5. System voltage		-	I	I	I	I	I	I	I	I	I	
BODY												
1. All chassis bolts and nuts (tighten)		-	I	T	T	T	T	T	T	T	T	
2. All Latches, Hinges & Locks (function)		I	I&L	I&L	I&L	I&L	I&L	I&L	I&L	I&L	I&L	

Interval: This interval should be judged by odometer reading or months, whichever comes first	km (x 1,000) months	FREE INSPECTIONS			PERIODIC MAINTENANCE SERVICE AT COST						
		1	5	10	20	30	40	50	60	70	80
		1	6	12	24	36	48	60	72	84	96
ROAD TEST											
1. Operation of Brakes, Gear shifting & speedometer											
2. Body and Chassis noise											
AIR CONDITIONER (if equipped)											
1. Check belt tension											
2. Check Receiver Drier bubbles.											
3. Tighten compressor mounting bolts		-	T	T	T	T	T	T	T	T	T
4. Check all hose joints, tighten if necessary											
5. Check functioning of Recirc flap											
6. Clean condenser with low pressure water		-	C	C	C	C	C	C	C	C	C
7. Check belt for frayed edges, change if necessary		-									
8. Check all mounting bolts		-									

⚠ WARNING

The rear shock absorbers are filled with high pressure gas. Never attempt to disassemble it or throw it into a fire. Avoid storing it near a heater or heating device. When scrapping the absorber, the gas must be released from the absorber safely. Ask your dealer for assistance.

DRIVE BELT

⚠ WARNING

- All maintenance should be carried out with the ignition switch in the "OFF" position and the car parked securely on the level ground unless otherwise specified.
- If you are in any way unsure of your ability to undertake a task, then do not start it but contact your Maruti dealer to perform the work for you.

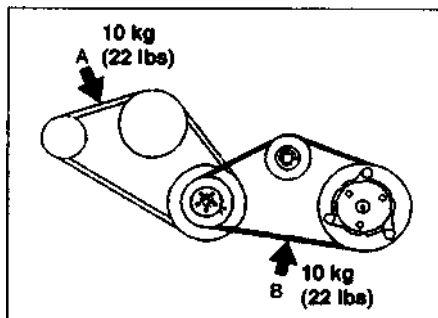

79F-09-001E

⚠ WARNING

When the engine is running, keep hands, hair, clothing, tools, etc. away from the fan and drive belt. Even though the fan may not be moving, it can automatically turn on without warning.

Water pump belt (A)	8 - 9 mm
Air conditioner belt (B)	8 - 9 mm

The belt should also be examined to ensure that it is not damaged. If the belt needs to be replaced or adjusted, have it done by your MARUTI dealer.

Make sure the drive belt, tension is correct. If the belt is too loose, insufficient battery charging, engine overheating, or excessive belt wear can result. When you press the belt with your thumb midway between the pulleys, the belt deflection should be within the specification below.

ENGINE OIL AND FILTER

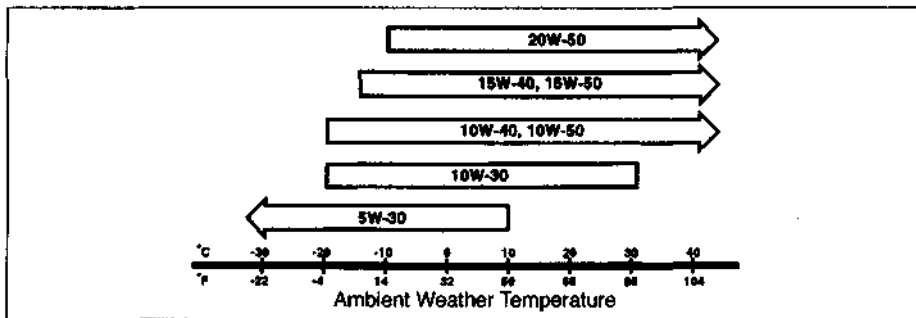

70F-07-004E

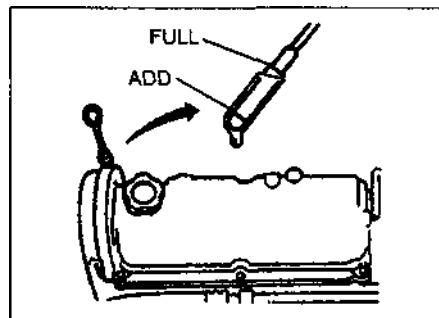

79F-09-002E

Specified oil

Be sure that the engine oil you use comes under the API classification of SF, SG or SH. Select the appropriate oil viscosity according to the above chart.

Oil Level Check

It is important to keep the engine oil at the correct level for proper lubrication of your vehicle's engine. Check the oil level with the vehicle on a level surface. The oil level indication may be inaccurate if the vehicle is on a slope. The oil level should be checked either before starting the engine or at least 5 minutes after stopping the engine.

Pull out the oil dipstick, wipe oil off with a clean cloth, insert the dipstick all the way into the engine, then remove it again. The oil on the stick should be between the upper and lower limits shown on the stick. If the oil level indication is near the lower limit, add enough oil to raise the level to the upper limit.

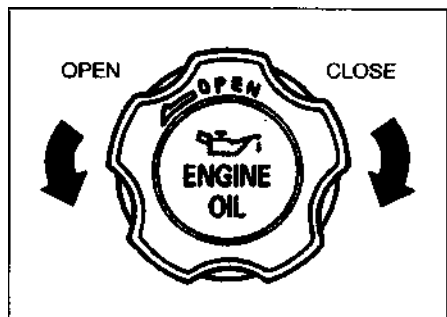

79F-09-003E

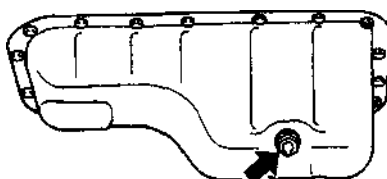

Tightening torque :
5.0 kg-m (36.5 lb-ft)

79F-09-004E

Refilling

Remove the oil filler cap and pour oil slowly through the filler hole to bring the oil level to the upper limit on the dipstick. Be careful not to overfill. Too much oil is almost as bad as too little oil. After refilling, start the engine and allow it to idle for about a minute. Stop the engine, wait for five minutes and check the oil level again.

Changing Engine Oil and Filter

Drain the engine oil while the engine is still warm.

- 1) Remove the oil filler cap.
- 2) Place a drain pan under the drain plug.
- 3) Using the correct spanner remove the drain plug and drain out the engine oil.

▲ WARNING

The engine oil temperature may be high enough to burn your fingers when the drain plug is loosened. Wait until the drain plug is cool enough to touch with your bare hands.

▲ WARNING

New and used oil can be hazardous. Children and pets may be harmed by swallowing new or used oil. Keep new and used oil and used oil filters away from children and pets. Continuous contact with used engine oil has been found to cause (skin) cancer in laboratory animals. Brief contact with used oil may irritate skin.

To minimize your exposure to used oil, wear a long-sleeve shirt and moistureproof gloves (such as dishwashing gloves) when changing oil. If oil contacts your skin, wash thoroughly with soap and water. Launder any clothing or rags if wet with oil.

Recycle or properly dispose of used oil and filters.

- 4) Reinstall the drain plug and gasket. Tighten the plug to a torque of 5.0 kg-m (36.5 lb-ft).

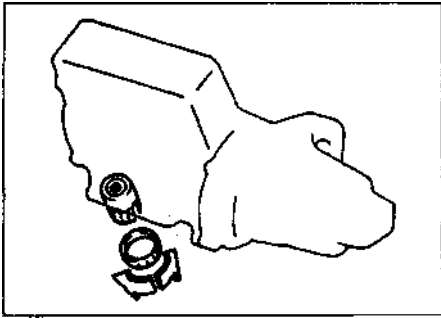

79F-09-004

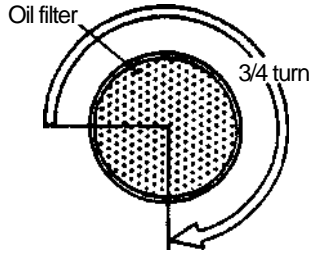

79F-09-005E

Replace the oil filter

- 1) Using an oil filter wrench, turn the oil filter counterclockwise and remove it.
- 2) Using a clean rag, wipe off the mounting surface on the engine where the new filter will be seated.
- 3) Smear a little engine oil around the rubber gasket of the new oil filter.
- 4) Screw on the new filter by hand until the filter gasket contacts the mounting surface.

▲ CAUTION

To tighten the oil filter properly, it is important to accurately identify the position at which the filter gasket first contacts the mounting surface.

- 5) Tighten the filter 3/4 turn from the point of contact with the mounting surface, [or to 1.4 kg-m (10.5 lb-ft)] using an oil filter wrench.

▲ CAUTION

To prevent oil leakage, make sure that the oil filter is tight, but do not overtighten it.

Refill with oil and check for leaks.

- 1) Pour oil through the filler hole and install the filler cap.
For the approximate capacity of the oil, refer to the "CAPACITIES" item in the "SPECIFICATIONS" section.
- 2) Start the engine and look carefully for leaks at the oil filter and drain plug. Run the engine at various speeds for at least 5 minutes.
- 3) Stop the engine and wait for 5 minutes. Check the oil level again and add oil if necessary. Check for leaks again.

▲ CAUTION

When replacing the oil filter, it is recommended that you use a genuine MARUTI replacement filter.

▲ CAUTION

Oil leaks from around the oil filter or drain plug indicate incorrect installation or gasket damage. If you find any leaks or are not sure that the filter has been properly tightened, have the vehicle inspected by your MARUTI dealer.

GEAR OIL

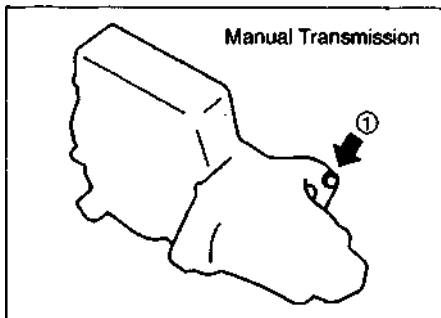

709F-07-012E

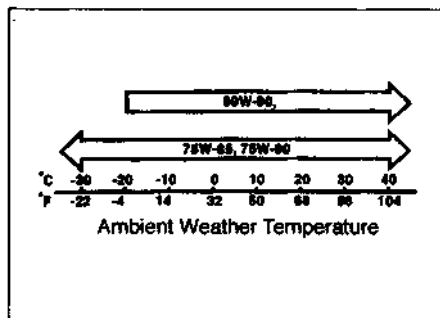

70F-07-013E

Oil filler and level plug ①
 Tightening torque: 2.1 kg-m (15.5 lb-ft)

Specified Manual Transmission oil

When adding gear oil, use the appropriate viscosity and grade as shown in the chart below. We highly recommend you use API GL-4 SAE 75W-90 gear oil.

Type of oil Gear oil, API GL-4

Gear oil level check

To check the gear oil level, use the following procedure:

- 1) Park the vehicle on a level surface with the parking brake applied.
- 2) Clean casing around oil filler plug to remove risk of any loose dirt or debris entering oil filler plug hole. Remove the oil filler plug ①.
- 3) Feel the inside of the hole with your finger. If the oil level comes up to the bottom of the plug hole, the oil level is correct. If so, reinstall the plug.
- 4) If the oil level is low, add gear oil through the filler plug hole ① until the oil level reaches the bottom of the filler hole, then reinstall the plug.

▲ WARNING

After driving the vehicle, the transmission oil temperature may be high enough to burn you. Wait until the oil filler plug is cool enough to touch with your bare hands before inspecting transmission oil.

▲ CAUTION

When tightening the plug, apply sealing compound to the plug threads to prevent oil leakage.

Gear oil change

Since special procedures, materials and tools are required, it is recommended that you trust this job to your authorized MARUTI dealer.

ENGINE COOLANT

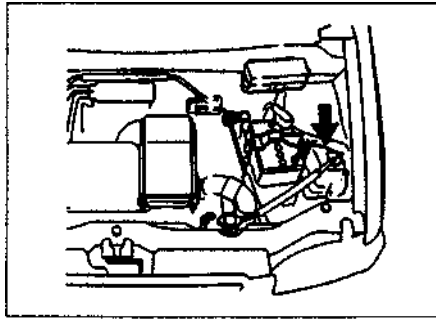

79F-09-009

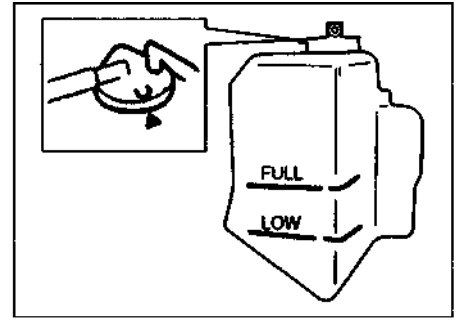

Coolant Level Check

Check the coolant level at the reservoir tank, not at the radiator. With the engine cool, the coolant level should be between the "FULL" and "LOW" marks.

Adding Coolant

If the Coolant level is below the "LOW" mark, more coolant should be added. Remove the reservoir tank cap and add coolant until the reservoir tank level reaches the "FULL" mark. Never fill the reservoir tank above the "FULL" mark.

CAUTION

- When adding or replacing coolant, use a high quality ethylene glycol antifreeze and anticorrosion (Non-Amine type) diluted with distilled water. If the lowest ambient temperature in your area is expected to be -15°C (5°F) or above, make the antifreeze concentration of the mixture you use at least 30% but no more than 50%. If -16°C (3°F) or below, make the concentration at least 50%. If the 50% concentration does not provide adequate protection against freezing, follow the instructions on the antifreeze

INSPECTION AND MAINTENANCE

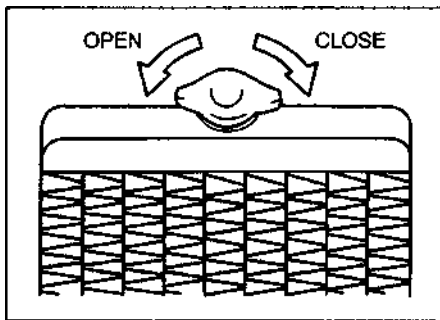

70F-07-019E

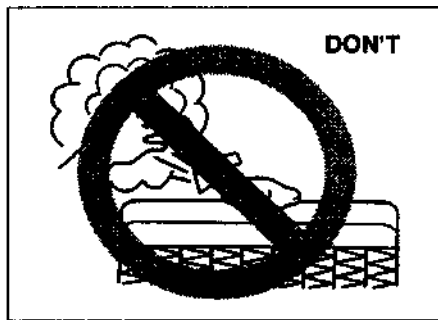

60G-09-039E

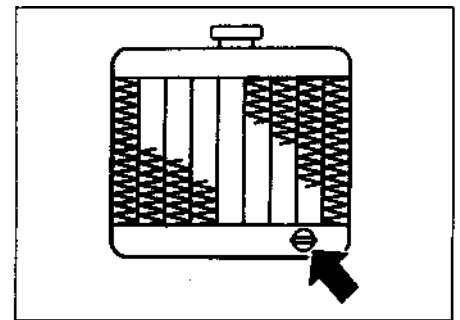

70F-07-017

CAUTION

- When putting the cap on the reservoir tank, line up the arrow on the cap and the arrow on the tank, or coolant can leak out.

WARNING

It is dangerous to remove the radiator cap when the water temperature is high, because scalding fluid and steam may be blown out under pressure. Wait until the coolant temperature has lowered before removing the cap.

- 3) Loosen the drain plug attached to the lower part of the radiator and drain the coolant into a suitable container.
- 4) Tighten the drain plug on the radiator, fill the radiator with coolant and install the radiator cap.
- 5) Refit the reservoir and fill it with the correct coolant to the "FULL" line. Refit the reservoir tank cap, ensuring the arrows are correctly aligned.

CAUTION

The coolant must be replaced with the vehicle on level ground.

Coolant Replacement

- 1) When the engine is cool, remove the radiator cap by turning it slowly to the left until a "stop" is felt. Do not press down while turning the cap. Wait until any pressure is released, then press down on the cap and continue turning it anticlockwise.

- 2) Remove the reservoir tank cap. Remove the reservoir by lifting it up, and drain the reservoir completely by pouring the coolant in to a suitable container.

WINDSCREEN WASHER FLUID

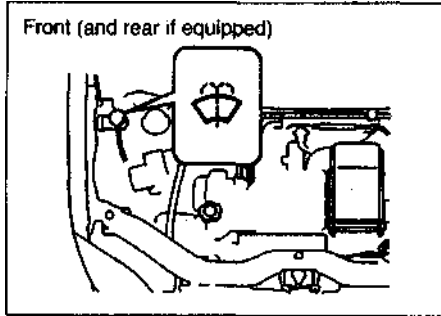

79F-09-011E

Check that there is washer fluid in the tank. Refill it if necessary. Use a good quality windscreen washer fluid, diluted with water as necessary.

▲ WARNING

Do not use "antifreeze" solution in the windscreen washer reservoir. This can severely impair visibility when sprayed on the windscreen, and can also damage your vehicle's paint.

▲ CAUTION

Damage may result if the washer motor is operated whilst the fluid or fluid nozzles are frozen or with no fluid in the washer tank.

87

AIR CLEANER

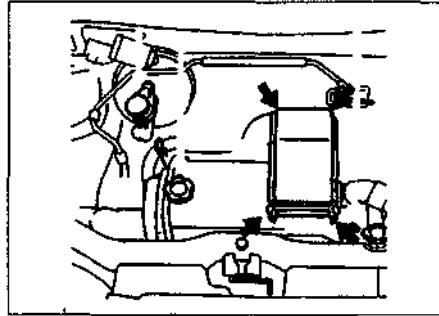

79F-09-012

If the air cleaner is clogged with dust, there will be greater intake resistance, resulting in decreased power output and increased fuel consumption.

Take out the air cleaner element after unhooking the clamps shown in the illustration. Blow off dust on air cleaner element by compressed air. If the air cleaner element appears to be dirty, replace it with a new one.

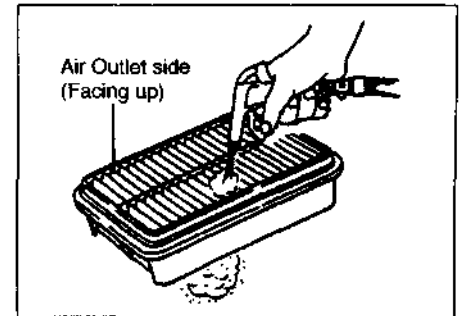

60G-09-010E

▲ CAUTION

The air cleaner element should be replaced every 40,000 km. More frequent replacement is necessary when you drive under dusty conditions.

INSPECTION AND MAINTENANCE

76G-74E

SPARK PLUGS

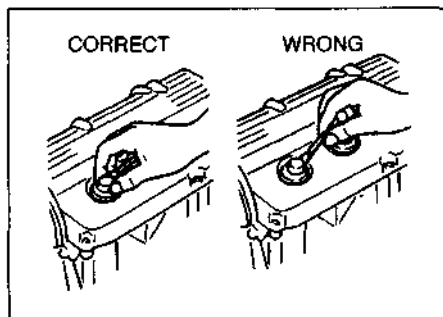

60G-09-011E

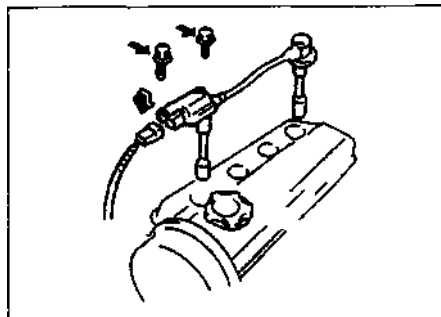

79F-09-013

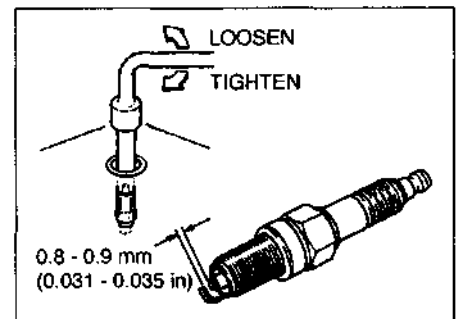

79F-09-014E

You should inspect spark plugs periodically for carbon deposits. When carbon accumulates on a spark plug, a strong spark may not be produced. Remove carbon deposits with a wire or pin and adjust the spark plug gap.

To access the spark plugs,

1. disconnect the coupler while pushing the release lever,
2. remove the bolts, and
3. pull the spark plug boots.

▲ CAUTION

- When disconnecting the spark plug cables, pull on the boot, not on the cable itself. Pulling on the cable can damage it.
- When installing the spark plugs, screw them in with your fingers to avoid stripping the threads. Tighten with a torque wrench to 1.3-2.2 kg-m (13.0-22.0 N-m, 9.4-15.9 lb-ft). Do not allow contaminants to enter the engine through the spark plug holes when the plugs are removed.
- Never use spark plugs with the wrong thread size or length.

▲ CAUTION

When replacing spark plugs, you should use the brand and type specified for your vehicle. For the specified plugs, refer to the "SPECIFICATIONS" section at the end of this book.

BRAKES

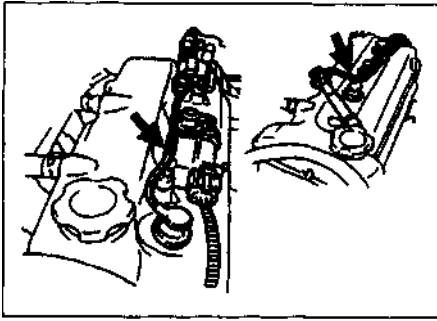

60G-09-013

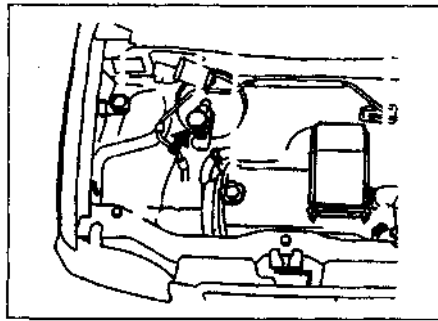

79F-09-015

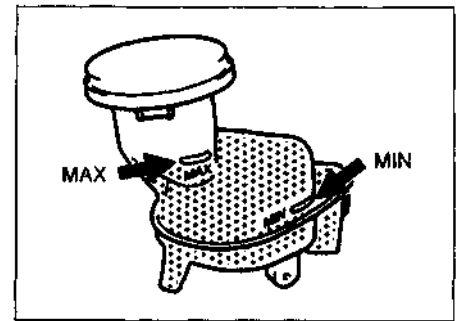

79F-09-016E

NOTE:

If you experience some firing problem of spark plugs, such as, hard engine-starting, misfire etc., the cause may be located not only on spark plugs but also on deteriorated ignition wiring (generally, used for more than 80,000 km or five years). If spark plug replacement does not solve the problem, have the ignition wiring and other ignition system inspected by your MARUTI dealer.

Brake Fluid

Check the brake fluid level by looking at the reservoir in the engine compartment. Check that the fluid level is between the "MAX" and "MIN" lines. If the brake fluid level is near the "MIN" line, fill it up to the "MAX" line with SAE J1703 or DOT-3 brake fluid.

▲ WARNING

Failure to follow the guidelines below can result in personal injury or serious damage to the brake system.

- If the brake fluid in the reservoir drops below a certain level, the brake warning light on the instrument panel will come on (the

▲ WARNING

- Parking brake must be fully disengaged with ignition switch in "ON" position). Should the light come on, immediately ask your MARUTI dealer to inspect the brake system.
- A rapid fluid loss indicates a leak in the brake system which should be inspected by your MARUTI dealer immediately.
- Brake fluid can harm your eyes and damage painted surfaces. Use caution when refilling the reservoir.

INSPECTION AND MAINTENANCE



70F-07-070

▲ WARNING

- Do not use any fluid other than SAE J1703 or DOT-3 brake fluid. Do not use reclaimed fluid or fluid that has been stored in old or open containers. It is essential that foreign particles and other liquids are kept out of the brake fluid reservoir.

▲ CAUTION

The brake fluid should be replaced every two years or 20,000 km.

NOTE:

With disc brakes, the fluid level can be expected to gradually fall as the brake pads wear.

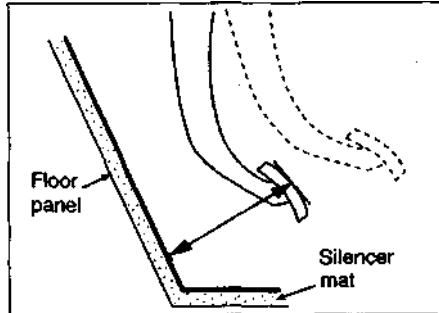

79F-09-017E

Brake Pedal

Check if the brake pedal stops at the regular height without "spongy" feeling when you depress it. If not, have the brake system inspected by your MARUTI dealer. If you doubt the brake pedal for the regular height, check it as follows:

With the engine running, measure the distance between the brake pedal and floor silencer mat when the pedal is depressed with approximately 30 kg (66 lbs) of force. The minimum distance required is 110 mm (4.3 in). Since your vehicle's brake system is self-adjusting, there is no need for pedal adjustment. If the pedal to floor wall distance as measured above is less than the minimum distance required, have your vehicle inspected by your MARUTI dealer.

NOTE:

When measuring the distance between the brake pedal and floor wall, be sure not to include any floor covering other than silencer mat in the measurement.

▲ WARNING

- If you experience any of the following problems with your vehicle's brake system, have the vehicle inspected immediately by your MARUTI dealer.
- Poor braking performance
 - Uneven braking (Brakes not working uniformly on all wheels.)
 - Excessive pedal travel
 - Brake dragging
 - Excessive noise
 - Pedal pulsation (Pedal pulsates when depressed.)

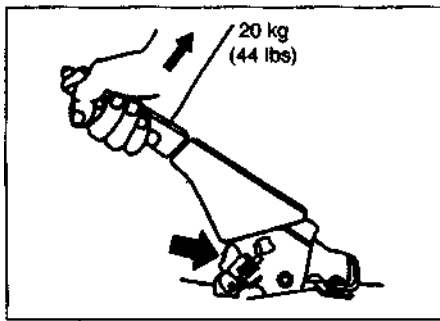

63B-09-005E

Parking brake

Check the parking brake for proper adjustment by counting the number of clicks made by the ratchet teeth as you slowly pull up on the parking brake lever to the point of full engagement. The parking brake lever should stop between the 7th and 9th ratchet tooth and the rear wheels should be securely locked. If the parking brake is not properly adjusted or the brakes drag after the lever has been fully released, have the parking brake inspected and/or adjusted by your MARUTI dealer.

STEERING

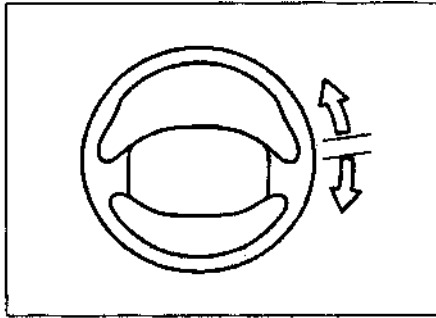

79F-09-018

Check the play of the steering wheel by gently turning it from left to right and measuring the distance that it moves before you feel slight resistance. The play should be between 0 - 30 mm (0.0 - 1.2 in).

Check that the steering wheel turns easily and smoothly without rattling by turning it all the way to the right and to the left while driving very slowly in an open area. If the amount of free play is outside the specification or you find anything else to be wrong, an inspection must be performed by your MARUTI dealer.

CLUTCH PEDAL

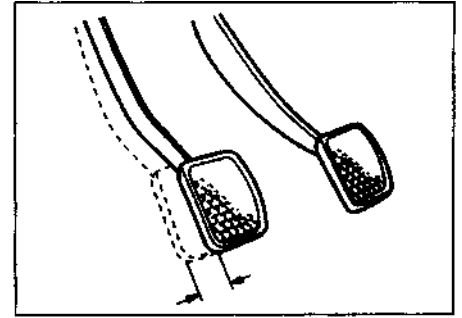

70F-07-034

Measure the clutch pedal play by moving the clutch pedal with your hand and measuring the distance it moves until you feel slight resistance. The play in the clutch pedal should be between 15 - 20 mm (0.6 - 0.8 in). If the play is more or less than the above, or clutch dragging is felt with the pedal fully depressed, have the clutch inspected by your MARUTI dealer.

INSPECTION AND MAINTENANCE

76G-74E

TYRES

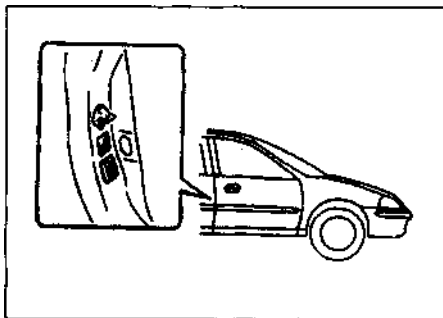

76G-09-005

The front and rear tyre pressure specifications for your vehicle are listed on the Tyre Inflation Pressure Label and in the "SPECIFICATIONS" section at the end of this book. Both the front and rear tyres should have the specified tyre pressure.

Tyre Inspection

Inspect your vehicle's tyres periodically by performing the following checks:

- 1) Measure the air pressure with a tyre gauge. Adjust the pressure if necessary.

⚠ WARNING

- Air pressures should be checked when the tyres are cold or you may get inaccurate readings,
- Check the inflation pressure from time to time while inflating the tyre gradually, until the specified pressure is obtained.
- Never underinflate or overinflate the tyres.

Underinflation can cause unusual handling characteristics or can cause the rim to slip on the tyre bead, resulting in an accident or damage to the tyre or rim. Overinflation can cause the tyre to burst, resulting in personal injury. Overinflation can also cause unusual handling characteristics which may result in an accident.

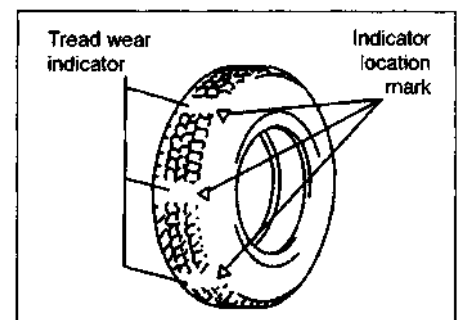

70F-07-037E

- 2) Check that the depth of the tread groove is more than 1.6 mm (0.06 in). To help you check this, the tyres have moulded-in tread wear indicators in the grooves. When the indicators appear on the tread surface, the remaining depth of the tread is 1.6 mm (0.06 in) or less and the tyre should be replaced.
- 3) Check for abnormal wear, cracks and damage. Any tyres with cracks or other damage should be replaced. If any tyres show abnormal wear, have them inspected by your MARUTI dealer.

⚠ WARNING
 Hitting curbs and running over rocks can damage tyres and affect wheel alignment. Be sure to have tyres and wheel alignment checked periodically by your MARUTI dealer.

- 4) Check for loose wheel nuts.
- 5) Check that there are no nails, stones, or other objects sticking into the tyres.

⚠ WARNING
 Your MARUTI is equipped with tyres which are all the same type and size. This is important to ensure proper steering and handling of the vehicle. Never mix tyres of different size or type on the four wheels of your vehicle. The size and type of tyres used should be only those approved by MARUTI as standard or optional equipment for your vehicle.

⚠ WARNING
 Replacing the wheels and tyres equipped on your vehicle with certain combinations of aftermarket wheels and tyres can significantly change the steering and handling characteristics of your vehicle. Therefore, use only those wheel and tyre combinations approved by MARUTI as standard or optional equipment for your vehicle.

⚠ CAUTION
 Replacing the original tyres with tyres of a different size may result in false speedometer or odometer readings.

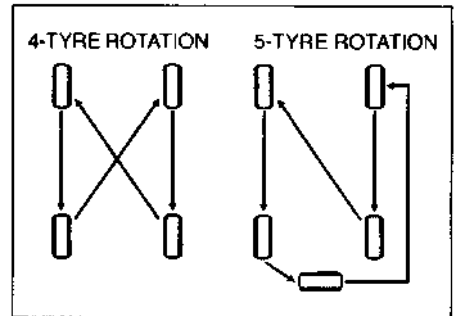

60G-09-019E

Tyre Rotation

To avoid uneven wear of your tyres and to prolong their life, rotate the tyres as illustrated. Tyres should be rotated every 5,000 km as recommended in the periodic maintenance schedule. After rotation, adjust front and rear tyre pressures to the specification listed on your vehicle's Tyre Inflation Pressure Label.

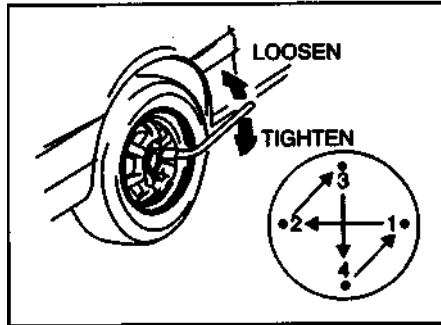
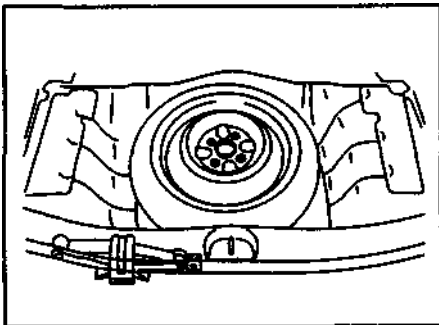

79F-0WH0E

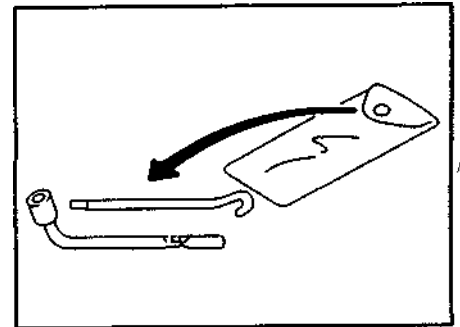

79F-0&022

Changing Wheels

To change a wheel, use the following procedure:

- 1) Remove the jack, tools and spare wheel from the vehicle.

NOTE:

If it is hard to loosen the bolt that secures the spare tyre, use the jack crank as illustrated.

- 2) Loosen, but do not remove the wheel nuts.
- 3) Jack up the vehicle (follow the jacking instructions in the EMERGENCY SERVICE section in this manual)

- 4) Remove the wheel nuts and wheel.
- 5) Install the new wheel and replace the wheel nuts with their cone shaped end facing the wheel. Tighten each nut snugly by hand until the wheel is securely seated on the hub.
- 6) Lower the jack and fully tighten the nuts [to 8.5 kg-m (61.5 lb-ft)] in a crisscross fashion with a wrench as shown in the illustration.

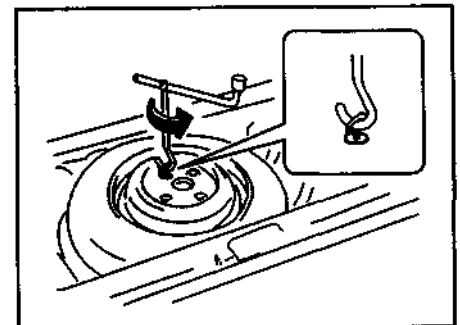

79F-0&023

BATTERY

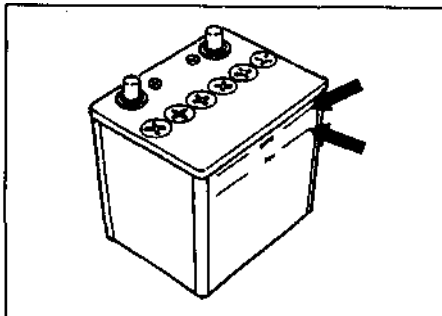

60G-09-038

⚠ WARNING
 To avoid harm to yourself or damage to your vehicle or battery, follow the jump starting instructions in the EMERGENCY SERVICE section of this manual if it is necessary to jump start your vehicle.

The level of the battery solution must be kept between the "UPPER" and the "LOWER" level lines at all times. If the level is found to be below the "LOWER" level line, add distilled water to the "UPPER" level line. You should periodically check the battery, battery terminals, and battery hold-down bracket for corrosion. Remove corrosion using a stiff brush and ammonia mixed with water, or baking soda mixed with water. After removing corrosion, rinse with clean water.

If your vehicle is not going to be driven for a month or longer, disconnect the cable from the negative terminal of the battery to help prevent discharge.

⚠ WARNING
 Batteries produce flammable hydrogen gas. Keep flames and sparks away from the battery or an explosion may occur. Never smoke when working in the vicinity of the battery .

⚠ WARNING
 When checking or servicing the battery, disconnect the negative cable. Be careful not to cause a short circuit by allowing metal objects to contact the battery posts and the vehicle at the same time.

FUSES

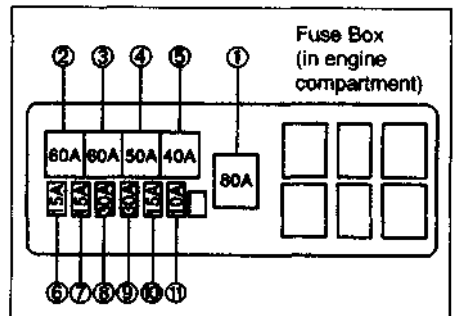

79F-09-021E

- Ⓒ. Main fuse
- Ⓒ. Primary fuse (IG)
- Ⓒ. Primary fuse (Not under ignition switch)
- Ⓒ. Empty
- Ⓒ. Empty
- Ⓒ. Headlight (R)
- Ⓒ. Headlight (L)
- Ⓒ. Heater fuse
- Ⓒ. Radiator fan motor fuse
- Ⓒ. Fuel injection system fuse
- Ⓒ. Air conditioner (If equipped)

INSPECTION AND MAINTENANCE

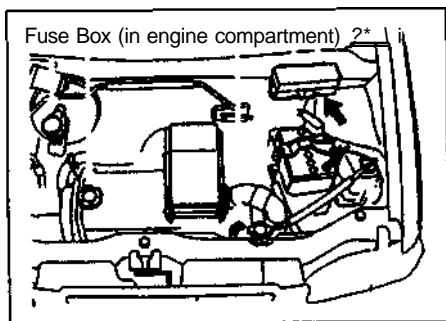

MAIN FUSE / PRIMARY FUSES	
80A	All Electric Load
60A (IG)	CIGAR, TURN/BACK, I.G./METER, HEATER, REAR DEFG, WIPER/WASHER, POWER WINDOW
60A	DOOR LOCK, TAIL, STOP, RADIO/DOME, HORN/HAZARD

Main Fuse and Primary Fuses
 The main fuse and primary fuses are located in the engine compartment. If the main fuse blows, no electrical component will function. If a primary fuse blows, no electrical component in the corresponding load group will function. When replacing the main fuse or a primary fuse, use a genuine MARUTI replacement.

⚠ WARNING
 If the main fuse or a primary fuse blows, be sure to have your vehicle inspected by an authorized MARUTI dealer. Always use a genuine MARUTI replacement. Never use a substitute such as a wire even for a temporary repair, or extensive electrical damage and a fire can result.

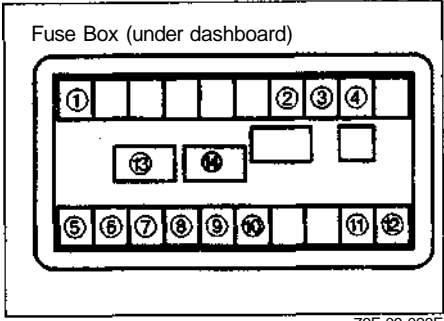

79F-09-023E

- ①. CIGAR 15A
 - ②. WIPER/WASHER 15A
 - ③. TURN/BACK 10A
 - ④. IG/METER 15A
 - ⑤.
 - ⑥. HORN HAZARD 15A
 - ⑦. RADIO/DOME 15A
 - ⑧. TAIL 10A
 - ⑨. STOP 10A
 - ⑩. DOOR LOCK 20A
 - ⑪.
 - ⑫. HEATER 10A
 - ⑬. POWER WINDOW* 30A
 - ⑭. FUSE PULLER
- * If equipped

This vehicle has three types of fuses, as described below :

Main Fuse - The main fuse takes current directly from the battery.

Primary Fuses - These fuses are between the main fuse and individual fuses, and are for electrical load groups.

Individual Fuses - These fuses are in the fuse box and for individual electrical circuits.

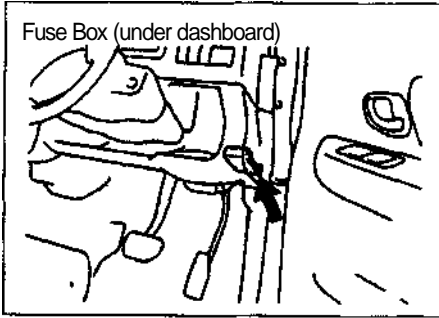

79F-09-024E

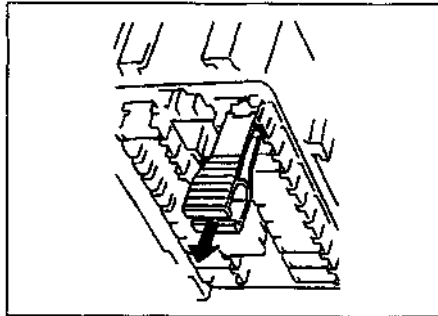

79F-09-025

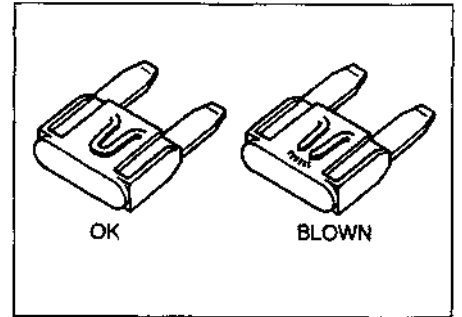

79F-09-026

Fuse Box

The fuse boxes are located in the engine compartment and under the driver's side of the dashboard.

To remove the fuse box cover under the dashboard pull off the cover.

NOTE:

To remove the fuse from the fuse box use the fork given in the fuse box (under dashboard) as shown in the illustration.

▲ WARNING

Always be sure to replace a blown fuse with a fuse of the correct amperage. Never use a substitute such as aluminium foil or wire to replace a blown fuse. If you replace a fuse and the new one blows in a short period of time, you may have a major electrical problem. Have your vehicle inspected immediately by your MARUTI dealer.

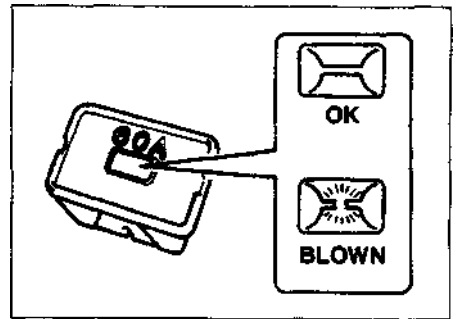

60G-09-028E

NOTE:

Make sure that the fuse box always carries spare fuses.

INSPECTION AND MAINTENANCE

BULB REPLACEMENT

▲ WARNING

- Light bulbs can be hot enough to burn your finger right after being turned off. This is true especially for halogen headlight bulbs. Replace the bulbs after they become cool enough.
- The headlight bulbs are filled with pressurized halogen gas. They can burst and injure you if they are hit or dropped. Handle them carefully.

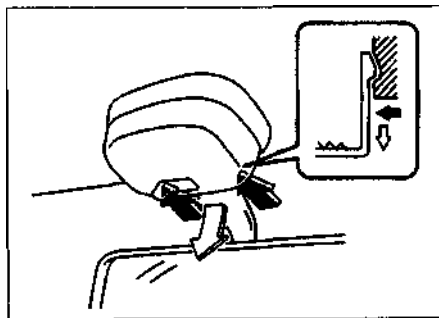

79F-09-027

▲ CAUTION

The oils from your skin may cause a halogen bulb to overheat and burst when the lights are on. Grasp a new bulb with a clean cloth.

Front Interior Light

Press the front part of the lens toward you and pull down the lens. To install it, simply push it back in.

The bulb can be removed by simply pulling it out. When replacing the bulb, make sure that the contact springs are holding the bulb securely.

▲ CAUTION

Frequent replacement of a bulb indicates the need for an inspection of the electrical system. This should be carried out by your MARUTI dealer.

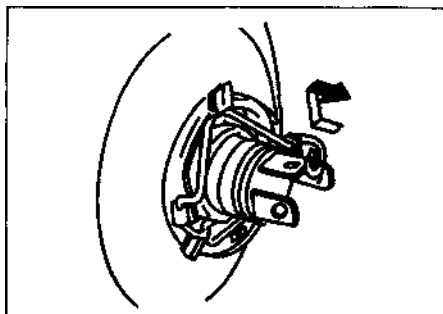

70F-07-049

Headlights

Open the bonnet. Disconnect the coupler. Remove the sealing rubber.

Push the retaining spring forward and unhook it. Then remove the bulb. Install a new bulb in the reverse order of removal.

Note:

Your vehicle is provided with two spare headlight bulbs for replacement in emergency.

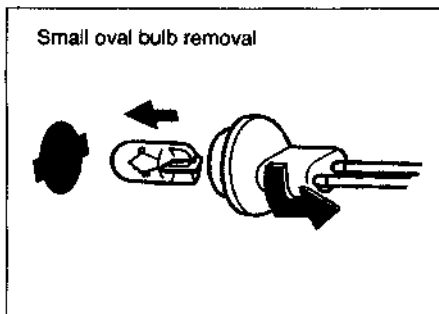

70F-07-050E

Front Clearance/Turn Signal Light, Side Turn Signal Light, rear Combination Light, Registration Plate Light.

To remove a bulb holder from a light housing, turn the holder counterclockwise and pull it out. To install the holder, push the holder in and turn it clockwise.

Two types (small oval and round) of bulb are used for these lights. To remove and install a small oval bulb, simply pull out or push in the bulb.

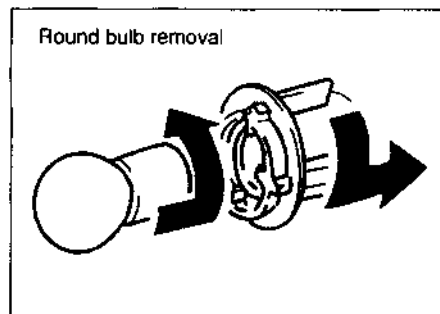

70F-07-051E

To remove a round bulb from a bulb holder, push in the bulb and turn it counterclockwise. To install a new bulb, push it in and turn it clockwise. You can access the individual bulb holders as described below:

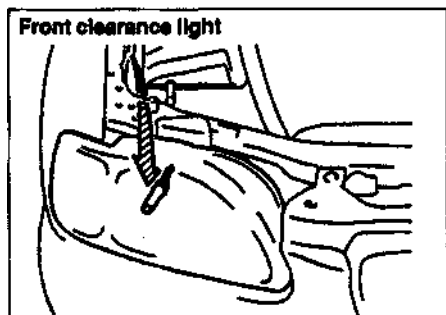

76G-09-002

Front clearance light

Trust this replacement job to your authorized MARUTI dealer as the front part of the front fender liner must be detached to replace the bulb.

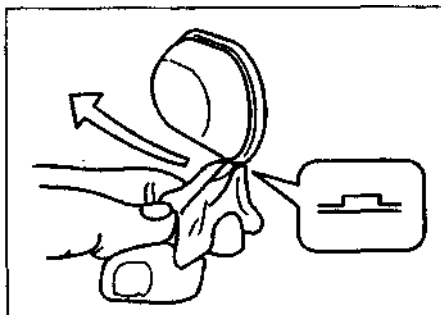

70F-07-054

Side turn signal light

Remove the lens by using a plain screw driver covered with a soft cloth.

WIPER BLADES

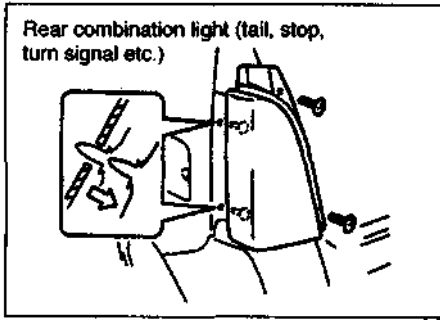

79F-09-031E

Rear combination light (tail, stop, turn signal, etc.)

Undo the screws that secure the housing and remove the housing by sliding in the direction of the white arrow in the illustration.

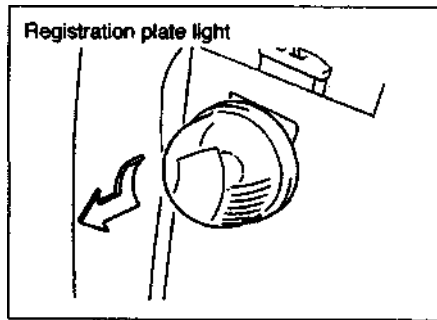

79F-09-032E

Registration plate light

Turn the lens counterclockwise and pull it off.

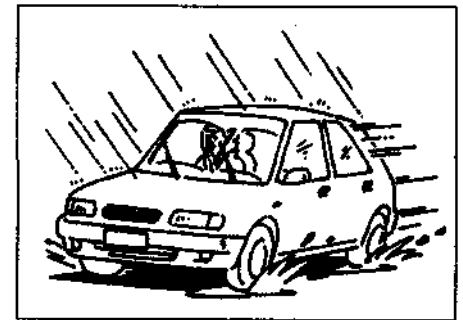

76G-09-004

If the wiper blades become brittle or damaged, or make streaks when wiping, replace the wiper blades.

To install new wiper blades, follow the procedure below.

▲ CAUTION

To avoid scratching or breaking the window, do not let the wiper arm strike the windshield while replacing the wiper blade.

INSPECTION AND MAINTENANCE

76G-74E

NOTE:

Some wiper blades may be different from the ones described here depending on vehicle specifications. If so consult your MARUTI dealer for proper replacement method.

▲ WARNING

The left and the right wiper arm assemblies are different from each other. In case you have to remove the wiper arm assemblies for any reason, remember not to interchange the two while fitting them back. Wrong fitment may lead to windshield breakage.

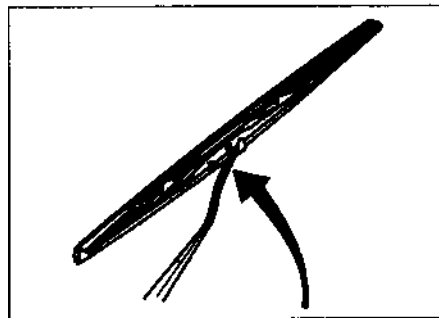

70F-07-060

For windshield wipers:

1. Hold the wiper arm away from the window.

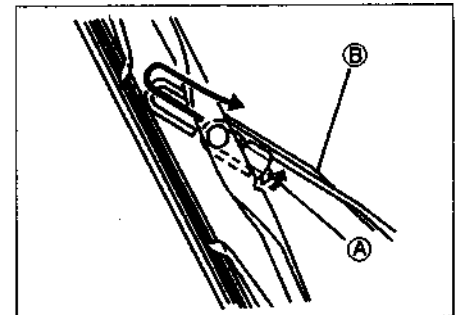

2. Squeeze lock lever (A) towards wiper arms (B) and remove the wiper frame from the arm as shown.